



US00D420851S

# United States Patent [19]

Wagner et al.

[11] Patent Number: **Des. 420,851**

[45] Date of Patent: **\*\* Feb. 22, 2000**

[54] **BARBECUE GRIDDLE**

[76] Inventors: **Richard G. Wagner; Lori Anne Wagner**, both of 9200 Grossmont Blvd., San Diego, Calif. 91941

[\*\*] Term: **14 Years**

[21] Appl. No.: **29/084,461**

[22] Filed: **Mar. 4, 1998**

[51] **LOC (7) Cl.** ..... **07-02**

[52] **U.S. Cl.** ..... **D7/407; D7/402**

[58] **Field of Search** ..... D7/332-337, 339-341, D7/347-348, 402-405, 363, 362; 126/9 R, 25 R, 25 A-25 AA, 26, 29-30, 38, 39 E, 39 L, 40, 41 R, 51, 39 H, 39 K, 39 J, 42; 99/419-420, 421 R, 421 H, 443 R-443 C, 422, 425, 444, 446, 423, 447; 219/436, 542

### [56] References Cited

#### U.S. PATENT DOCUMENTS

D. 130,444	11/1941	Howard	.....	D7/363
D. 192,776	5/1962	Lerner	.....	D7/363
D. 252,007	6/1979	Morgan	.....	D7/332
D. 373,702	9/1996	Perry	.....	D7/363
D. 396,598	8/1998	Van Der Woude	.....	D7/332
3,317,709	5/1967	Beasley	.....	219/449
3,339,994	9/1967	Reddig et al.	.....	D7/332
4,930,491	6/1990	Purello	.....	126/332
5,062,408	11/1991	Smith et al.	.....	126/41 R
5,413,032	5/1995	Bruno et al.	.....	99/331
5,619,910	4/1997	Farnsworth et al.	.....	99/422

5,678,531 10/1997 Byers et al. .... 126/25 R  
5,740,723 4/1998 Lin ..... 99/422

### OTHER PUBLICATIONS

Wells Condensed Catalog, "Wells Powerline Countertop Griddles: Six models from 2 to 6 ft. wide, four different tops" no pg. numbers.

*Primary Examiner*—Ruth McInroy  
*Attorney, Agent, or Firm*—Frank D. Gilliam

### [57] CLAIM

The ornamental design for a barbecue griddle, as shown and described.

### DESCRIPTION

FIG. 1 is a top and side perspective view of a barbecue griddle showing our new design;  
FIG. 2 is a left side elevational view thereof;  
FIG. 3 is a right side elevational view thereof;  
FIG. 4 is a rear elevational view thereof;  
FIG. 5 is a top plan view thereof;  
FIG. 6 is a front elevational view thereof;  
FIG. 7 is a bottom plan view thereof;  
FIG. 8 is a top and side perspective view of a second embodiment thereof;  
FIG. 9 is a left side elevational view of FIG. 8;  
FIG. 10 is a right side elevational view of FIG. 8;  
FIG. 11 is a rear elevational view of FIG. 8;  
FIG. 12 is a top plan view of FIG. 8;  
FIG. 13 is a front elevational view of FIG. 8; and,  
FIG. 14 is a bottom plan view of FIG. 8.

1 Claim, 2 Drawing Sheets

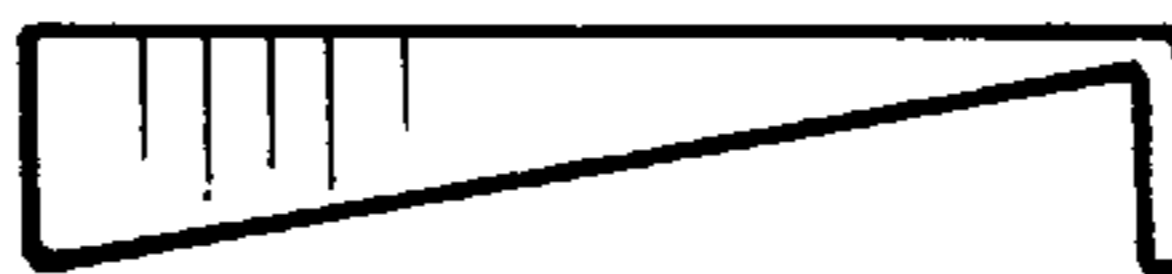
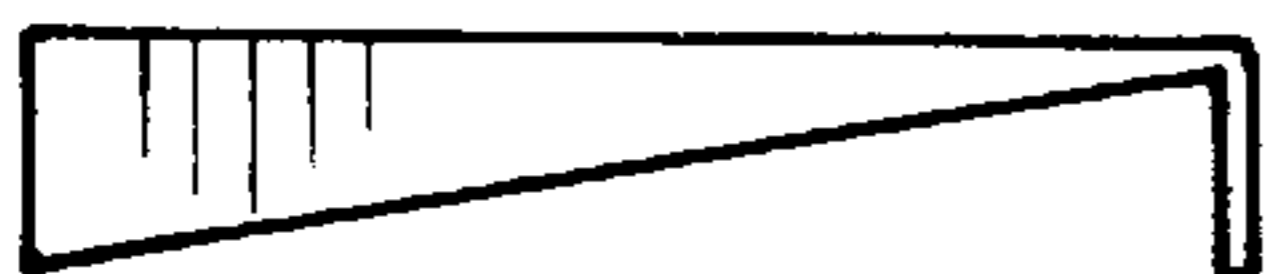
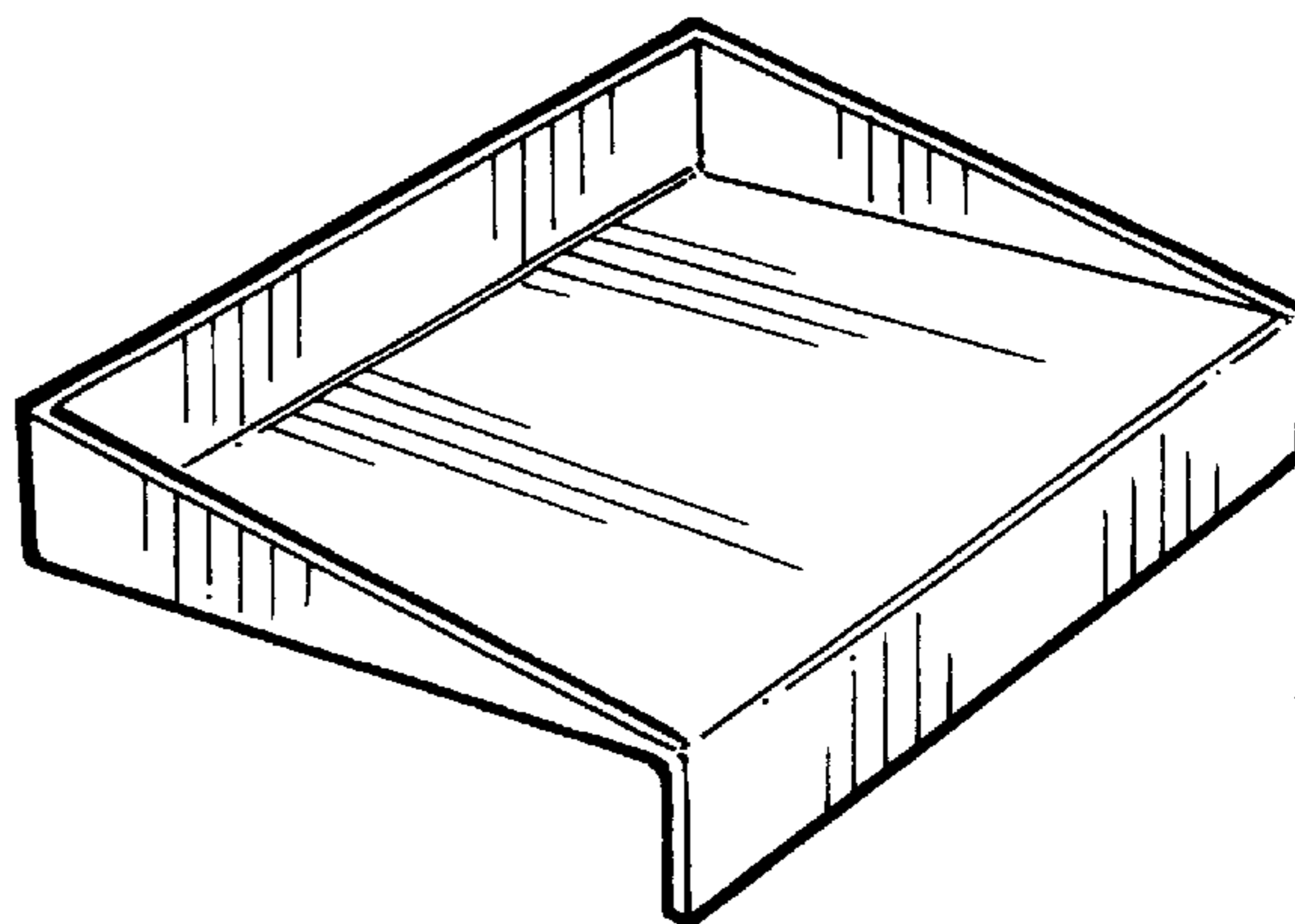
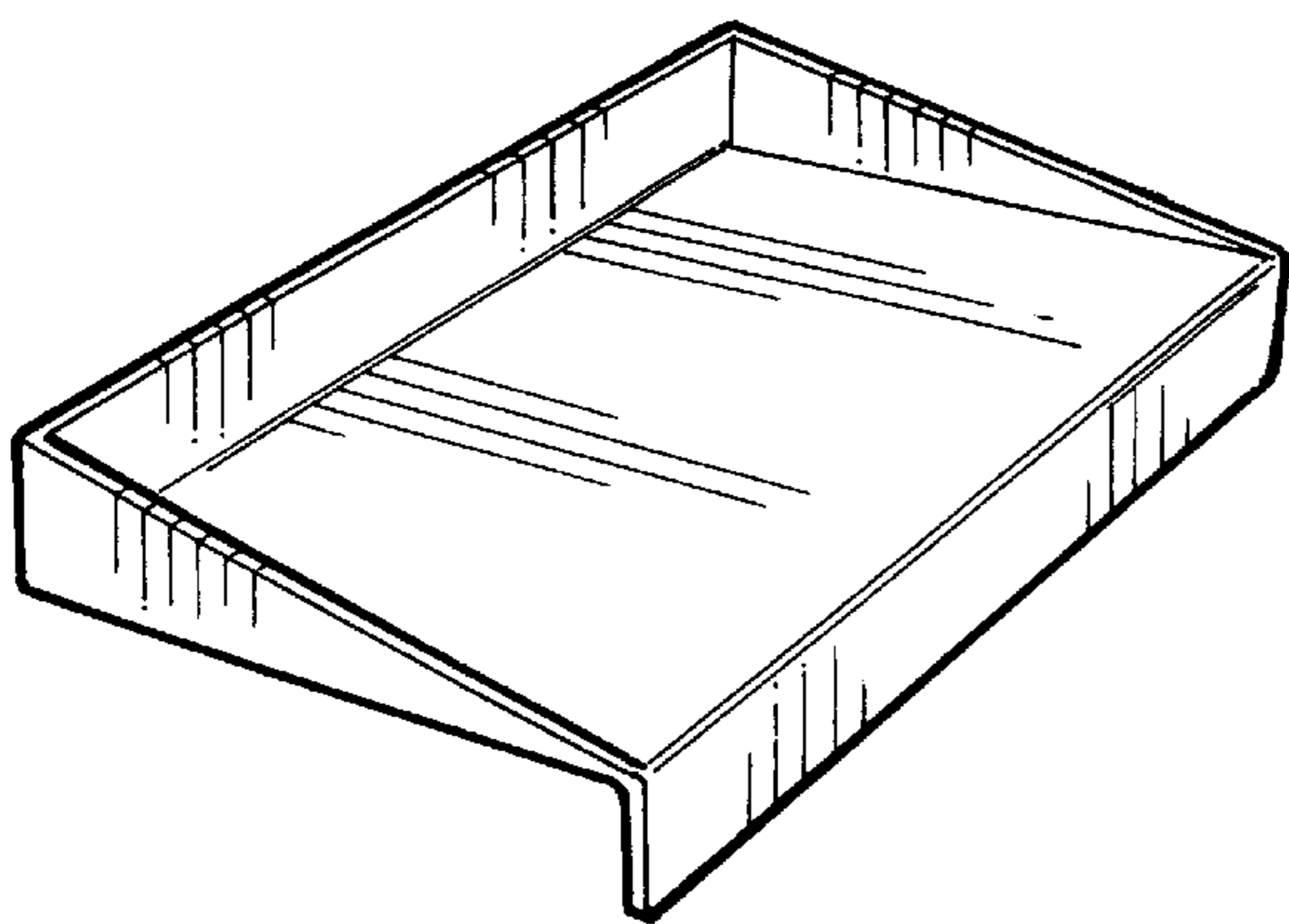

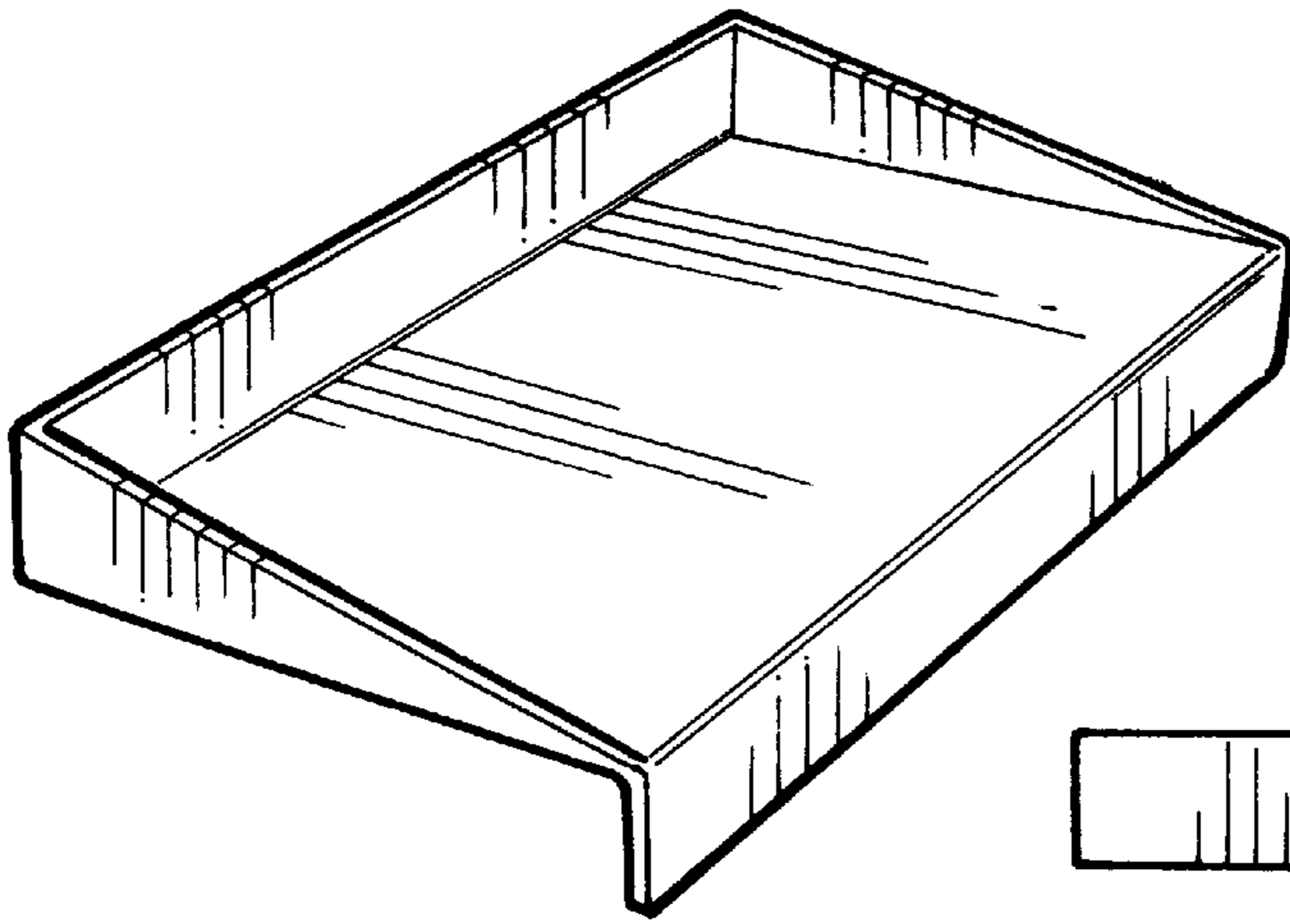

FIGURE 1

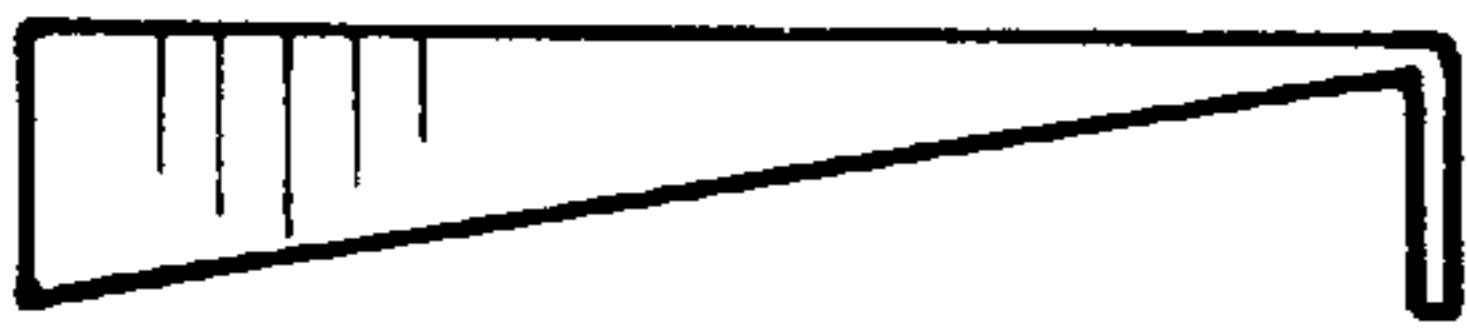

FIGURE 2

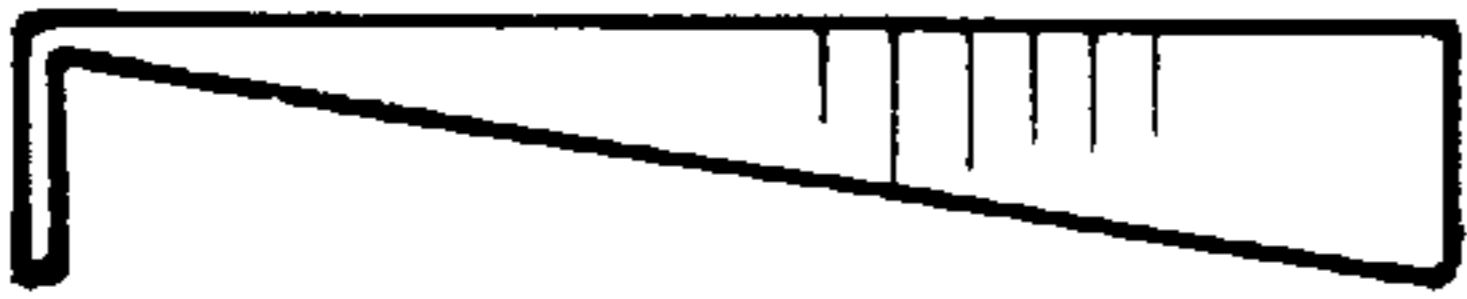

FIGURE 3



FIGURE 4

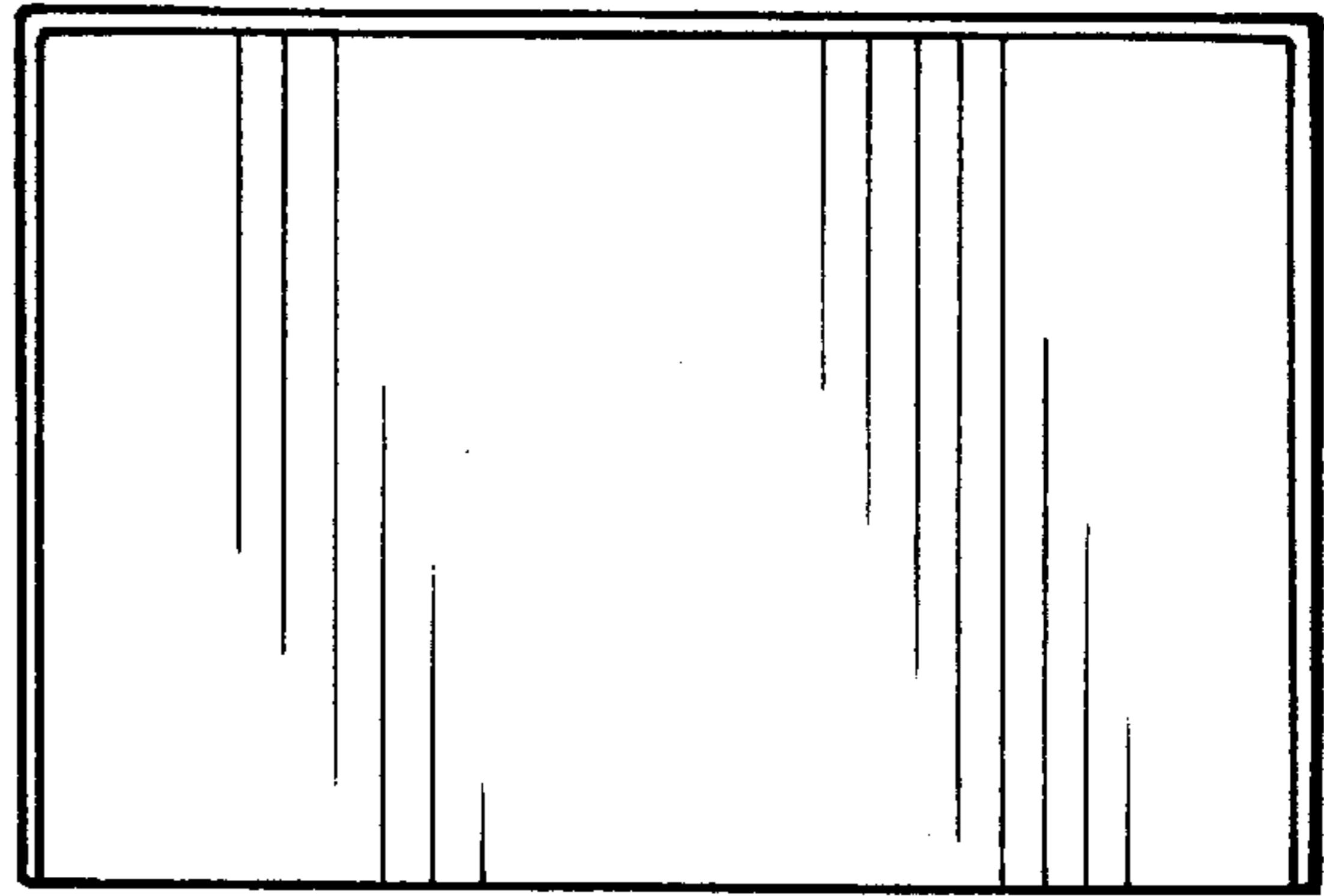

FIGURE 5



FIGURE 6

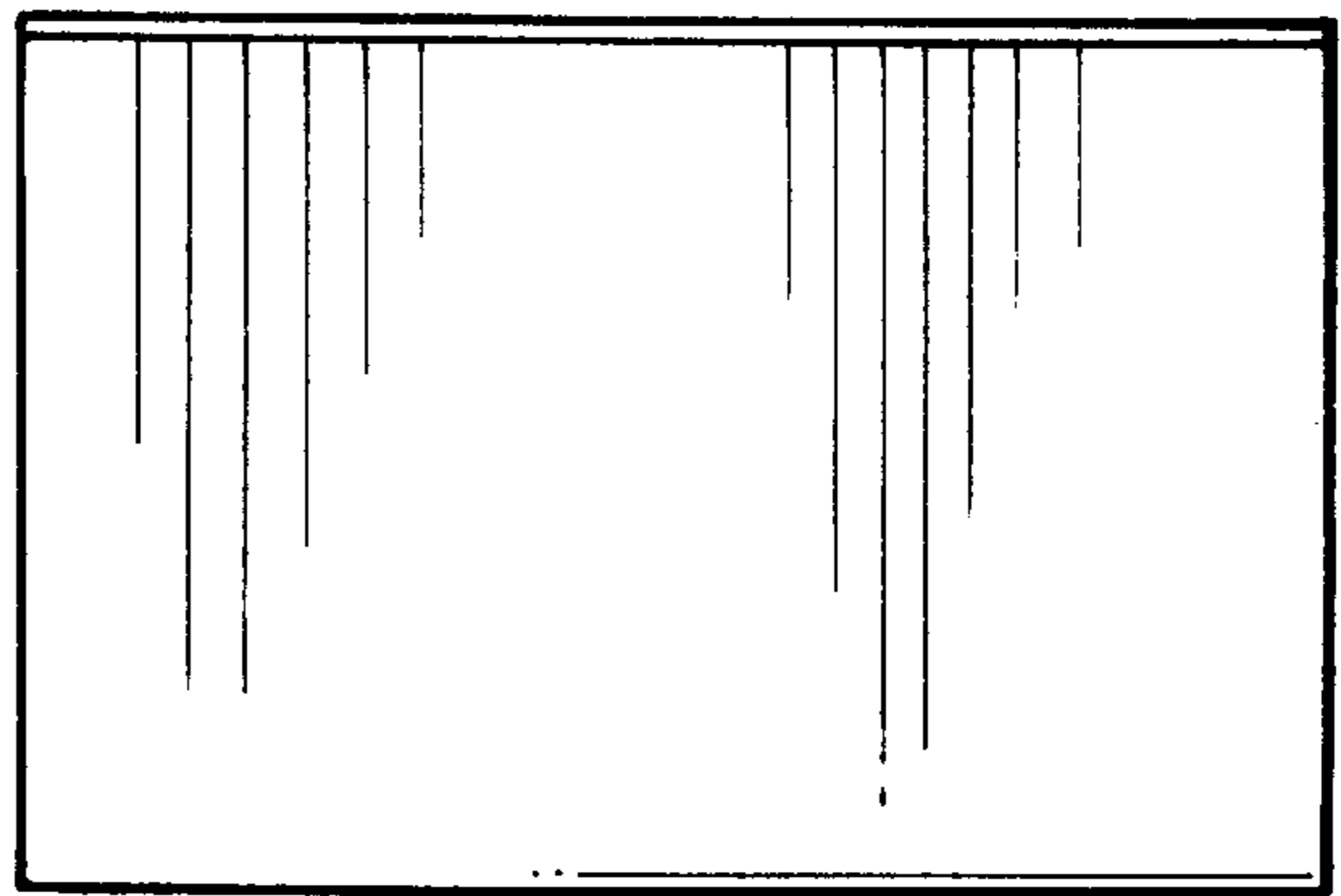

FIGURE 7

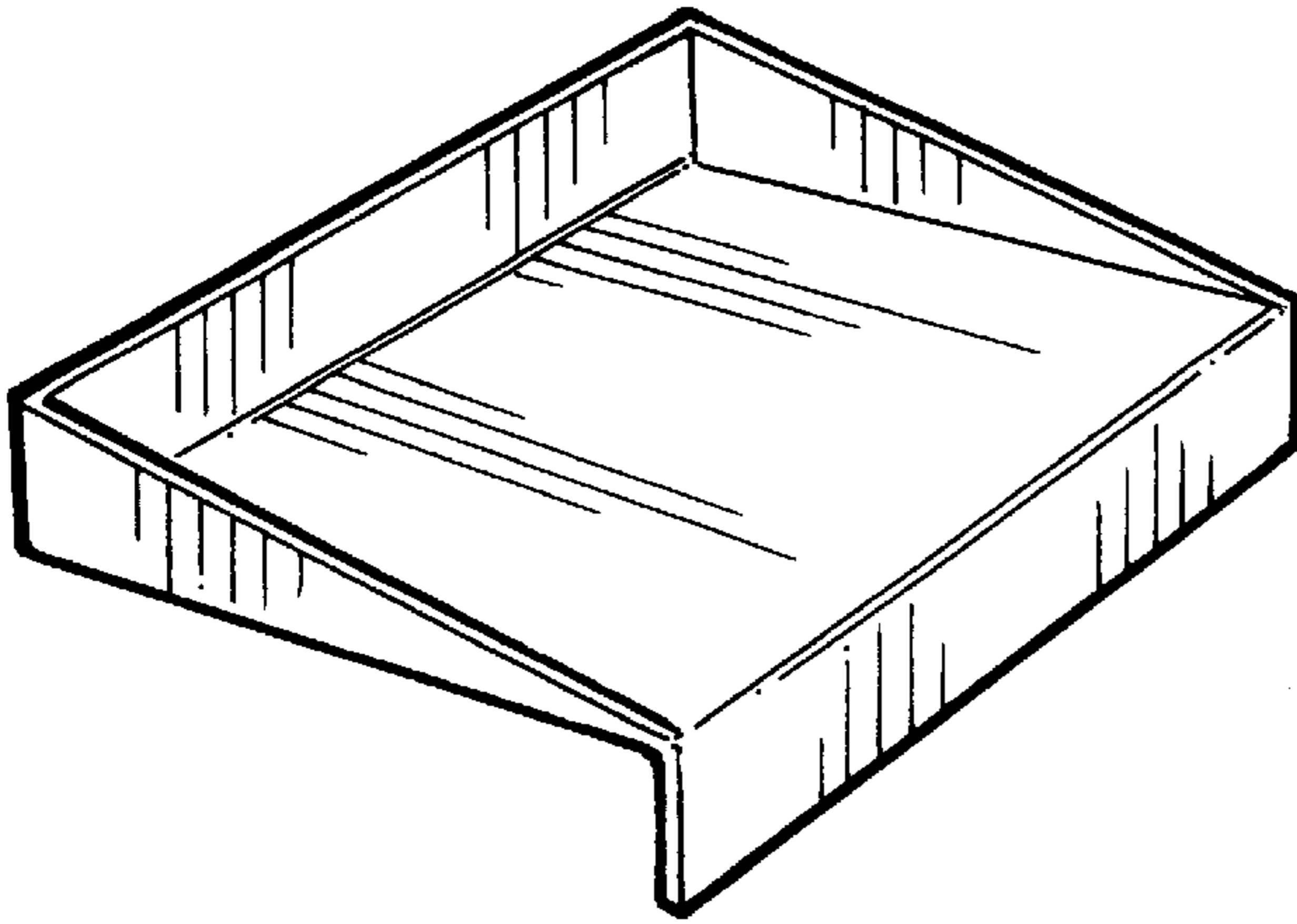

FIGURE 8

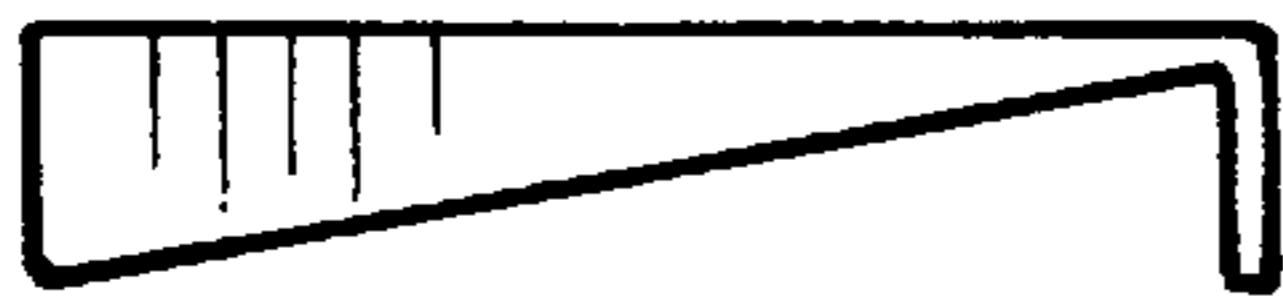

FIGURE 9



FIGURE 10



FIGURE 11

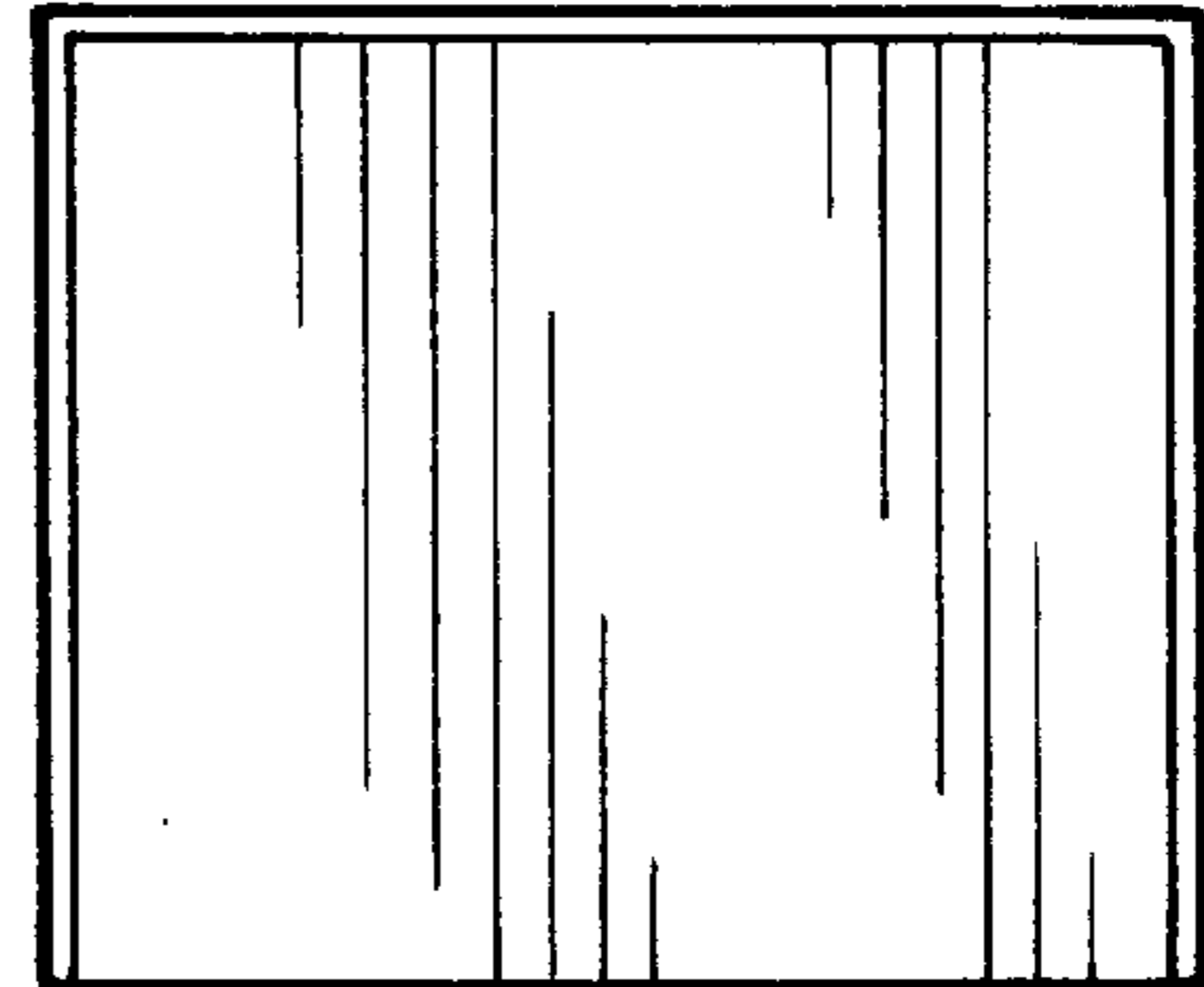

FIGURE 12

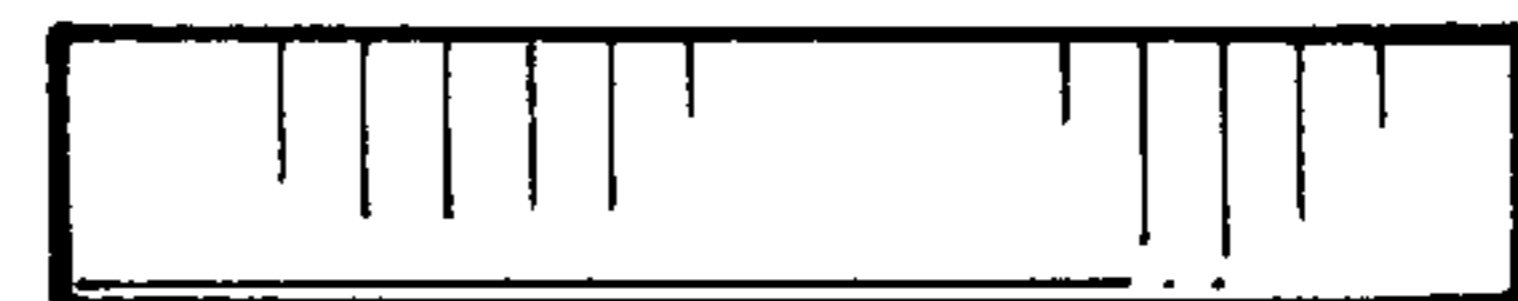

FIGURE 13

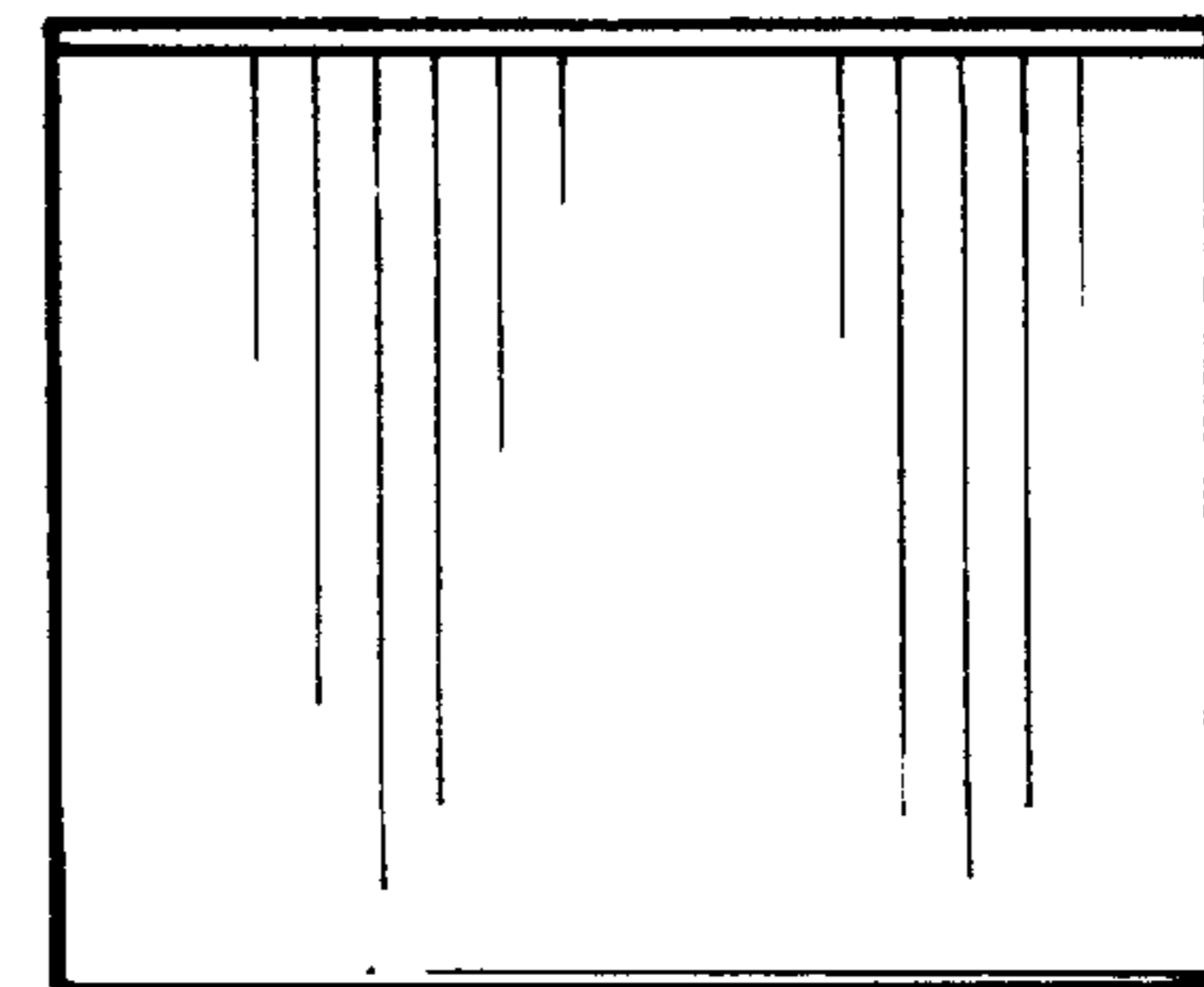

FIGURE 14