



US00D420485S

United States Patent [19] Cummings

[11] Patent Number: **Des. 420,485**

[45] Date of Patent: **** Feb. 8, 2000**

[54] **CASKET**

[75] Inventor: **Kenneth E. Cummings**, Mississauga, Canada

[73] Assignee: **Castek Environmental Products Inc.**, Richmond Hill, Canada

[**] Term: **14 Years**

[21] Appl. No.: **29/100,434**

[22] Filed: **Feb. 11, 1999**

[30] Foreign Application Priority Data

Aug. 12, 1998 [CA] Canada 1998-1947

[51] **LOC (7) Cl.** **99-00**

[52] **U.S. Cl.** **D99/1; D99/7**

[58] **Field of Search** D99/1, 2, 4, 6,
D99/7, 8, 11, 15, 16; 27/1, 2, 3, 4, 5, 6,
7, 8, 10, 14, 17

[56] References Cited

U.S. PATENT DOCUMENTS

D. 14,475	12/1883	Noble	27/6
D. 48,999	5/1916	Walker	D99/7
D. 112,054	11/1938	Christian	D99/7
D. 183,868	11/1958	Wallace	D99/1
D. 187,268	2/1960	Duke	D99/1
D. 355,747	2/1995	Tobin	D99/1
D. 374,960	10/1996	Tobin	D99/1

1,226,038	5/1917	Watkins	D99/74 R
1,780,171	11/1930	Clarke	27/2
2,655,712	7/1982	Glassner	27/2
4,253,220	3/1981	Work	.	
4,320,562	3/1982	Kelley	.	
4,800,631	1/1989	Pellmann	.	
4,890,366	1/1990	Schaapveld	.	
5,222,281	6/1993	Guérin	.	

OTHER PUBLICATIONS

York "Stainless Steel" brochure—8 pages, undated.
York "Steel Caskets" brochure—8 pages, undated.
York "Precious Metals" brochure—8 pages, undated.
York "Hardwood Caskets" brochure—8 pages, undated.

Primary Examiner—Paula A. Mortimer
Attorney, Agent, or Firm—Trevor C. Klotz

[57] CLAIM

I claim the ornamental design for a casket, as shown.

DESCRIPTION

FIG. 1 is a front perspective view taken from the left side showing my new design;
FIG. 2 is a top plan view of the design;
FIG. 3 is a bottom plan view of the design;
FIG. 4 is a front elevation of the design;
FIG. 5 is a rear elevation of the design;
FIG. 6 is a left side elevation of the design; and,
FIG. 7 is a right side elevation of the design.

1 Claim, 4 Drawing Sheets

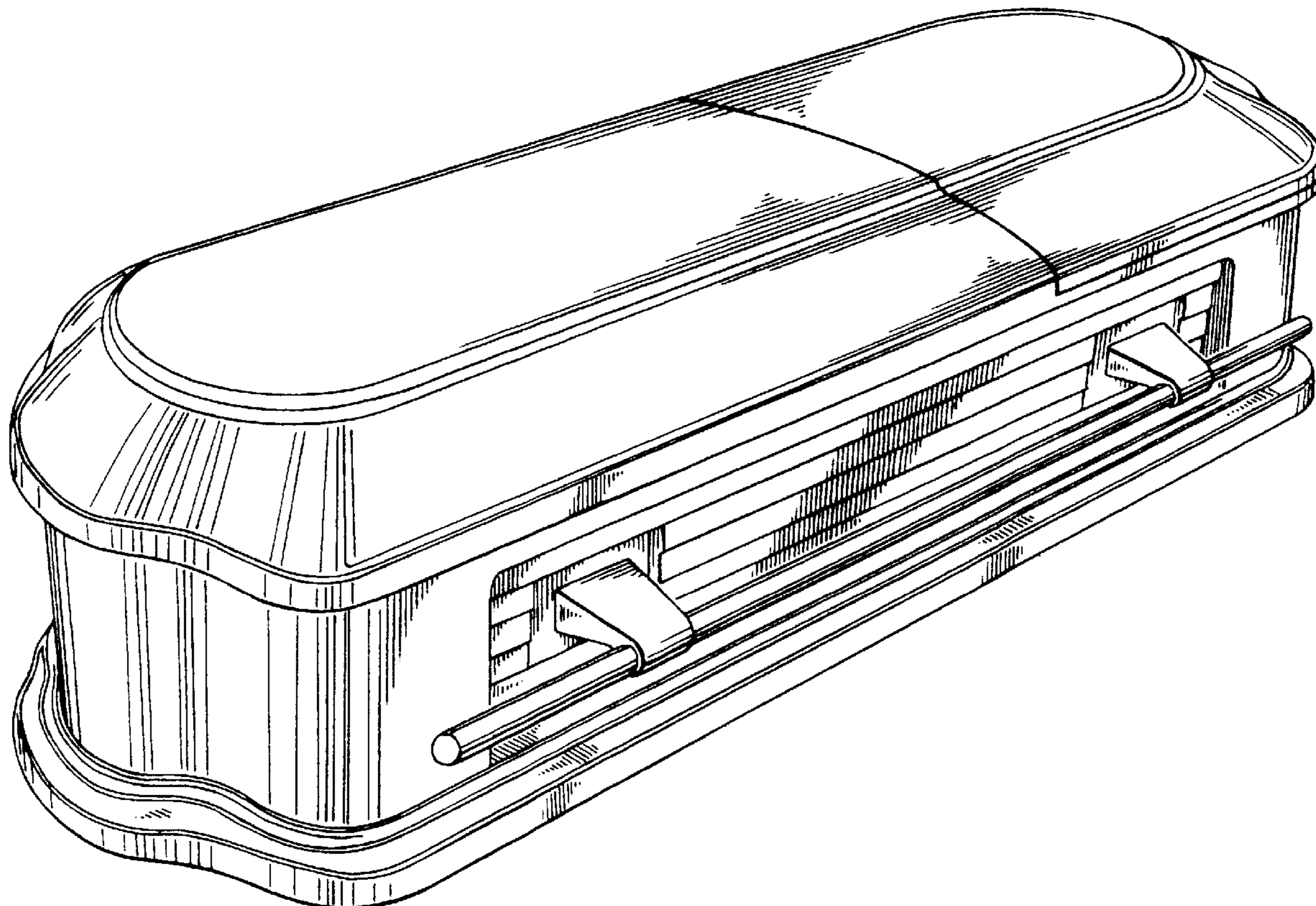

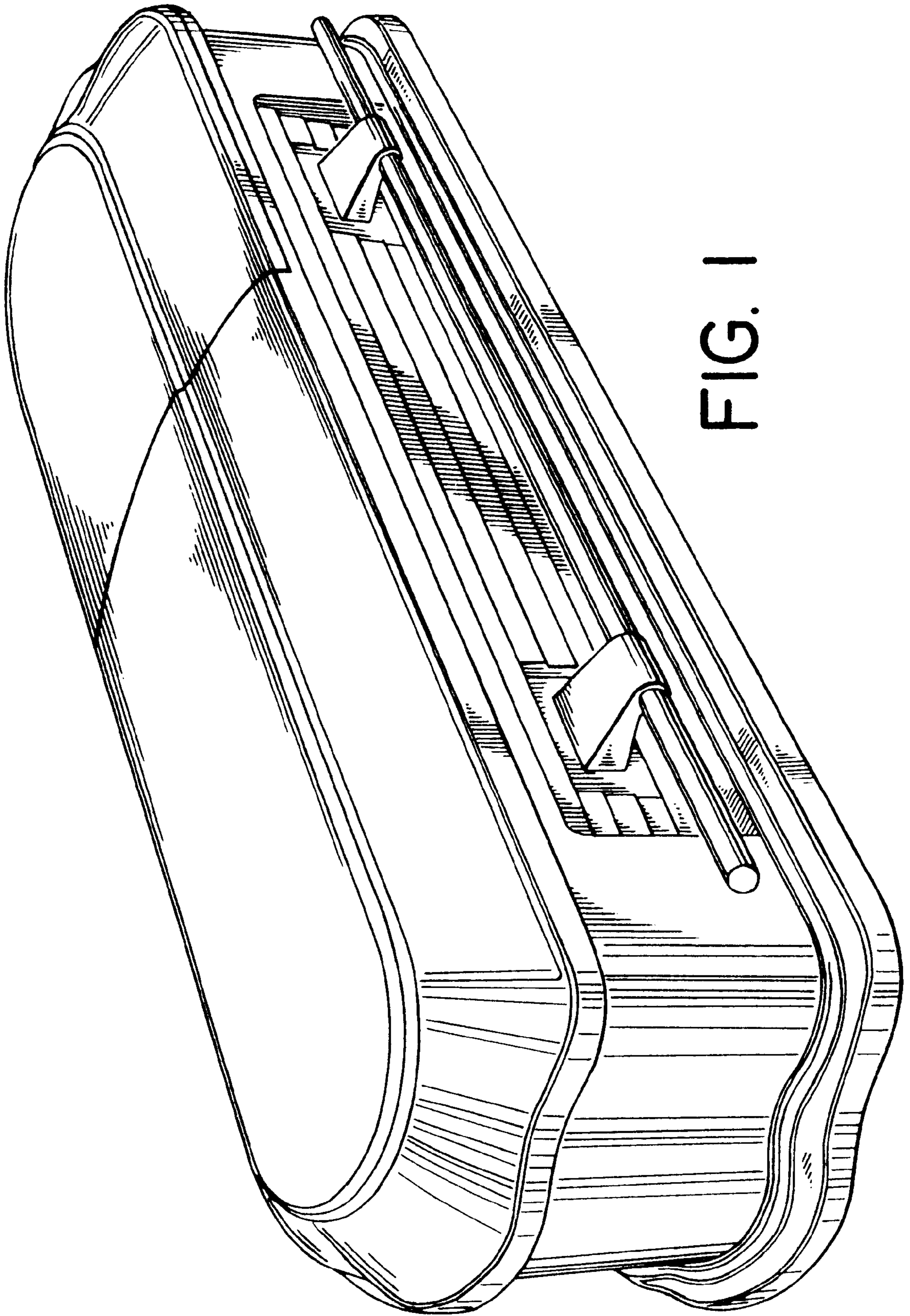
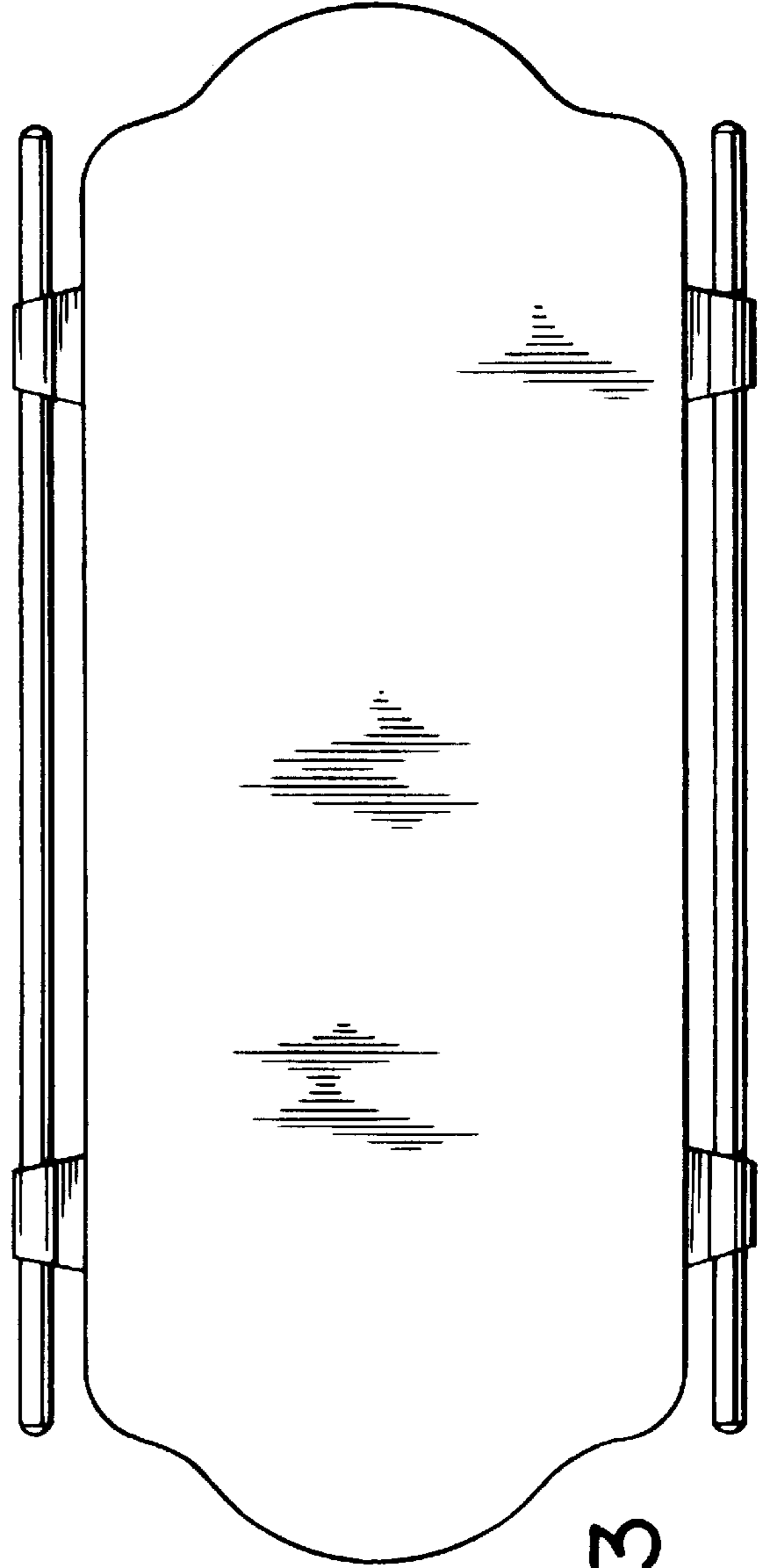
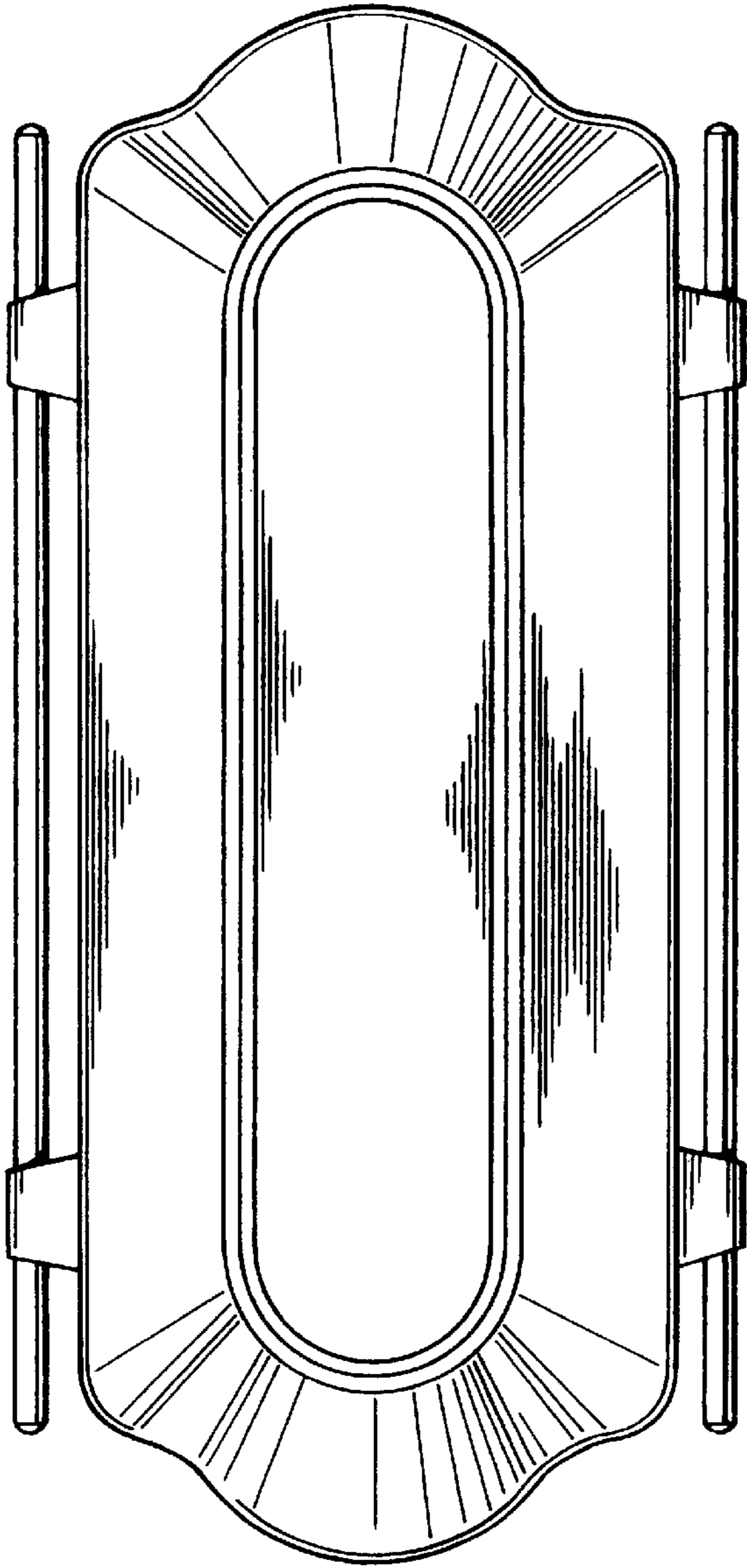

FIG. 1



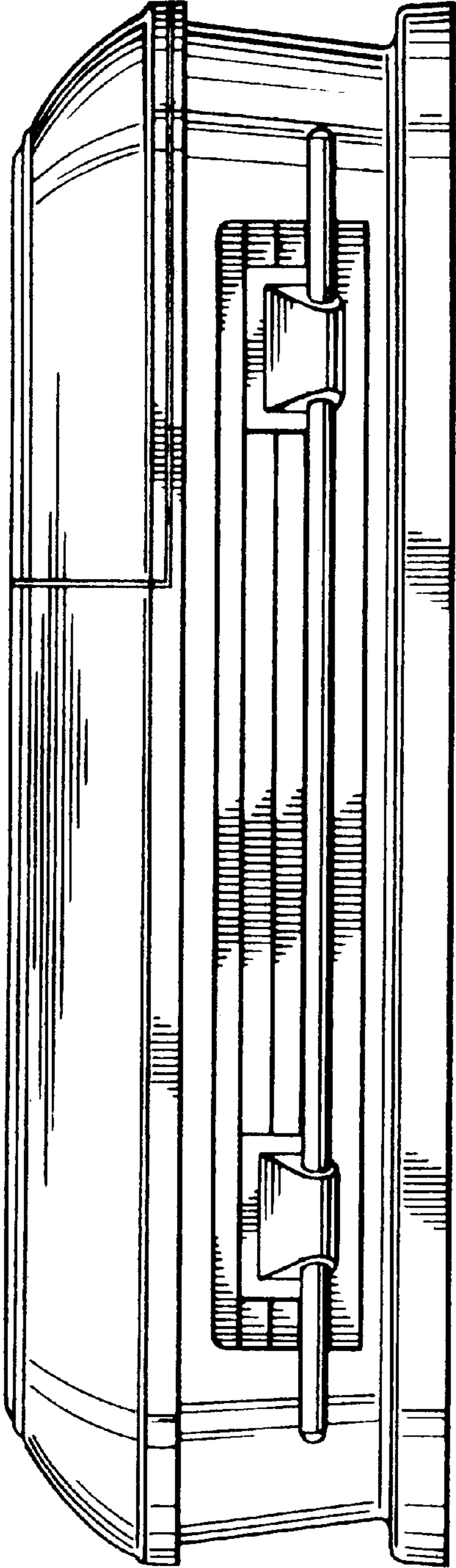

FIG. 4

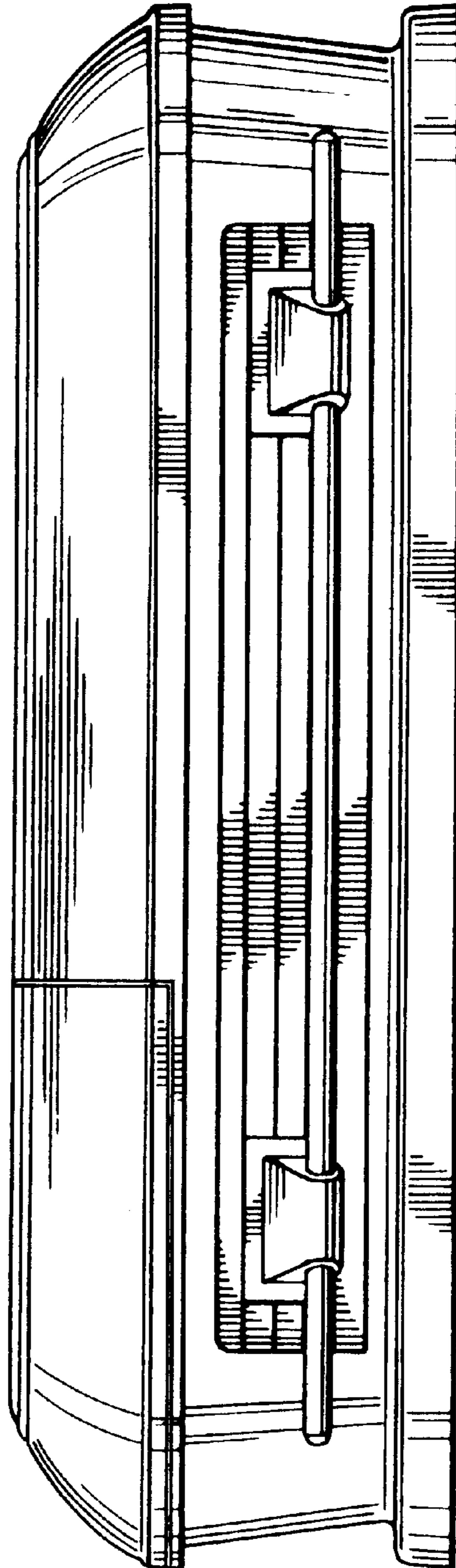

FIG. 5

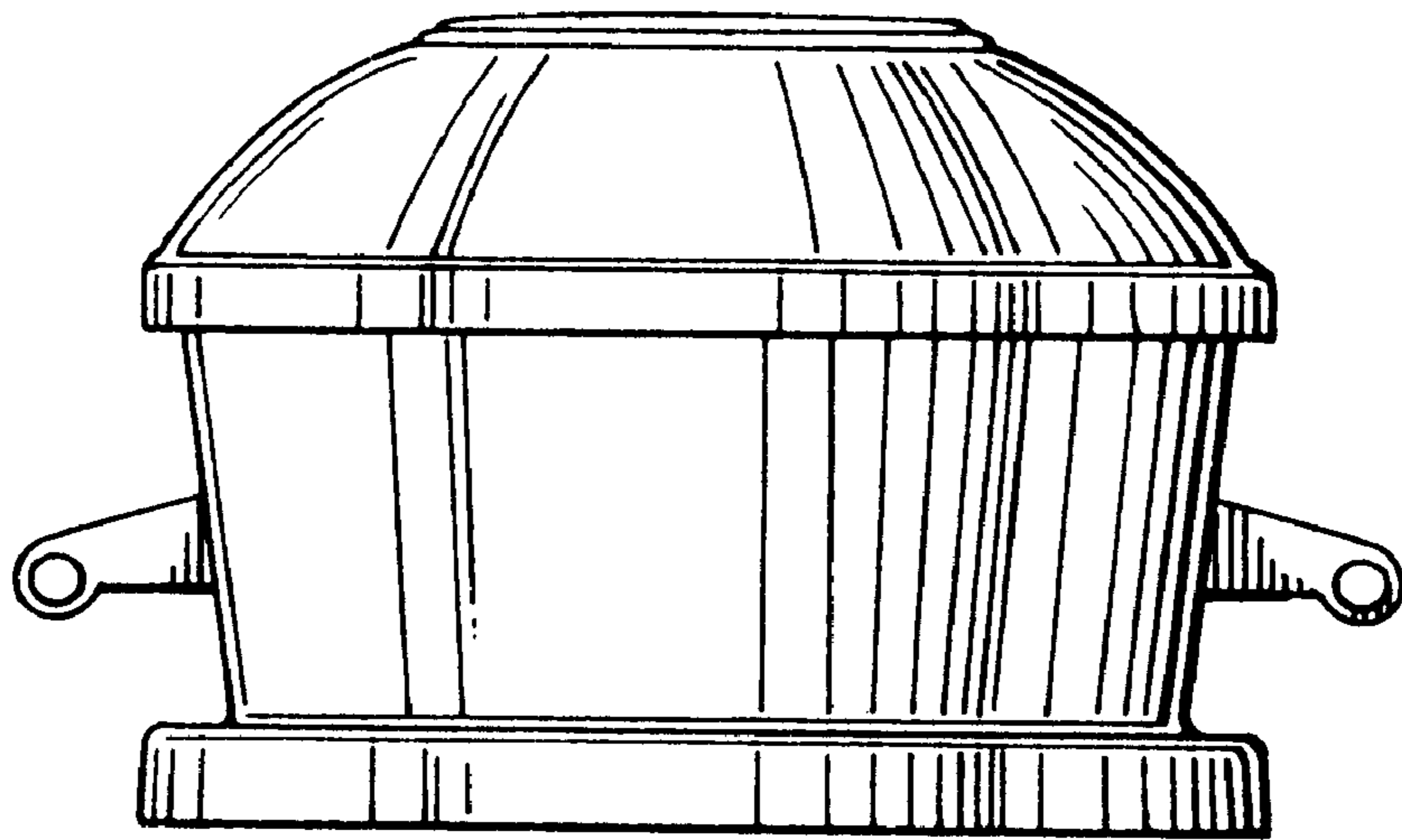

FIG. 6

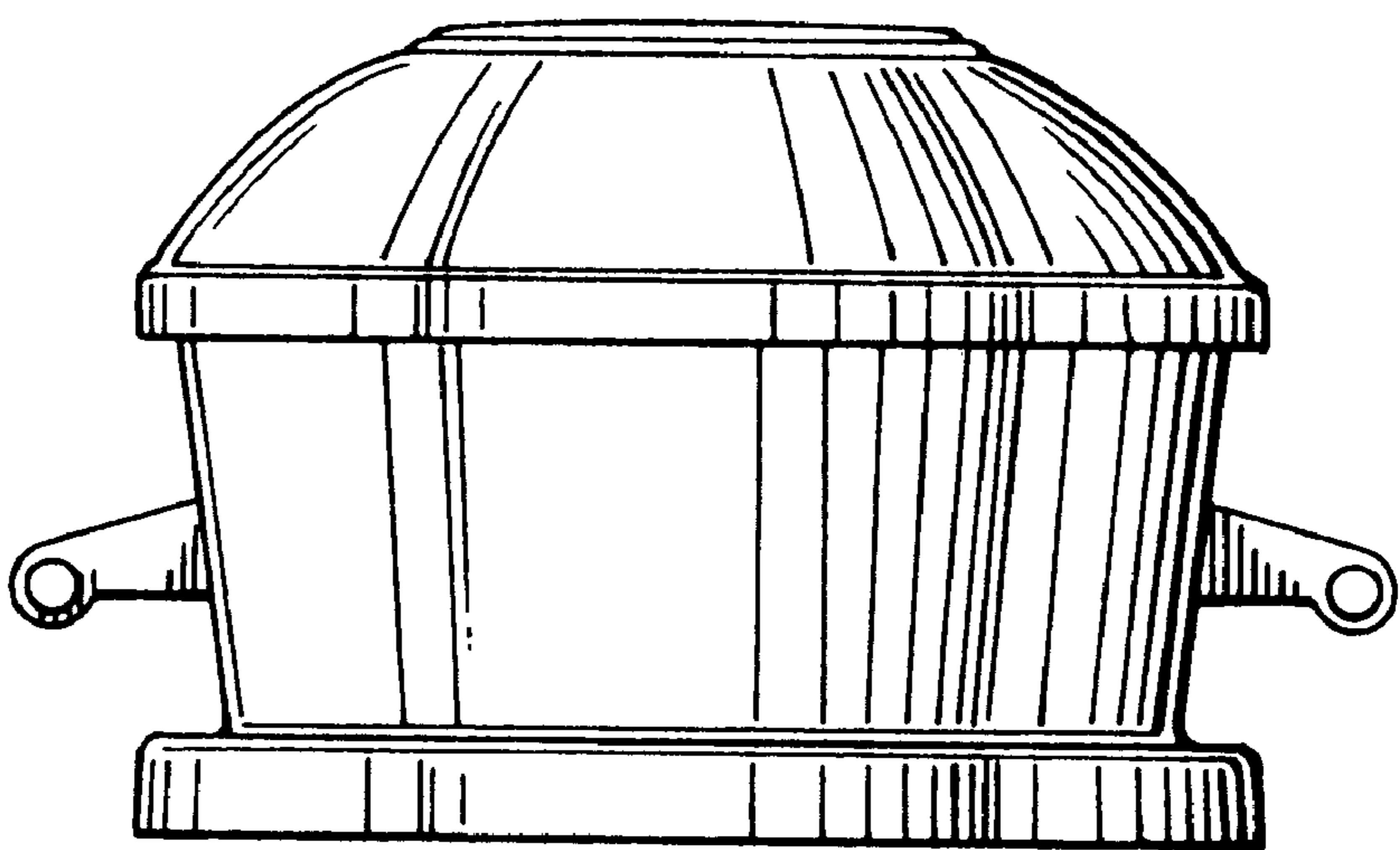

FIG. 7