



US00D420475S

United States Patent [19]

[11] Patent Number: Des. 420,475

Yuen

[45] Date of Patent: ** Feb. 8, 2000

[54] **COMBINED CORDLESS WET AND DRY VACUUM CLEANER**

[75] Inventor: **John Se-Kit Yuen**, Kowloon, The Hong Kong Special Administrative Region of the People's Republic of China

[73] Assignee: **John Se Kit Yuen**, Kowloon, The Hong Kong Special Administrative Region of the People's Republic of China

[**] Term: **14 Years**

[21] Appl. No.: **29/076,888**

[22] Filed: **Sep. 26, 1997**

[30] **Foreign Application Priority Data**

Mar. 27, 1997 [GB] United Kingdom 2064554

[51] **LOC (7) Cl.** **15-05**

[52] **U.S. Cl.** **D32/22**

[58] **Field of Search** D32/17, 18, 21-22, D32/31-34; 15/320-323, 329, 335, 344, 347, 350-351, 352, 361, 410, 412

[56] **References Cited**

U.S. PATENT DOCUMENTS

D. 303,171	8/1989	Goodrich et al.	D32/21
D. 359,604	6/1995	Sovis et al.	D32/22
D. 382,681	8/1997	Thomas	D32/22
D. 384,783	10/1997	Stohmeyer et al.	D32/22
D. 386,843	11/1997	Stohmeyer et al.	D32/384
5,392,490	2/1995	Monson	15/320

Primary Examiner—Ruth McInroy
Attorney, Agent, or Firm—Beall Law Offices

[57] **CLAIM**

The ornamental design for a combined cordless wet and dry vacuum cleaner, as shown and described.

DESCRIPTION

FIG. 1 is a left side elevational view of a combined wet and

dry cordless vacuum cleaner showing my new design;

FIG. 2 is a front elevational view thereof;

FIG. 3 is a right side elevational view thereof;

FIG. 4 is a rear elevational view thereof;

FIG. 5 is a bottom plan view thereof;

FIG. 6 is a top plan view thereof;

FIG. 7 is a bottom plan view of the floor brush thereof, shown in an alternate position;

FIG. 8 is a bottom plan view thereof, showing a further alternate position of the floor brush;

FIG. 9 is a right side elevational view thereof, showing the floor brush in an alternate position;

FIG. 10 is a right side elevational view thereof, showing the floor brush in another alternate position;

FIG. 11 is a right side elevational view thereof, showing the parts in an alternate position;

FIG. 12 is a bottom plan view of the main body thereof;

FIG. 13 is a top plan view of the main body thereof;

FIG. 14 is a left side elevational view of the main body thereof;

FIG. 15 is a front elevational view of the main body thereof;

FIG. 16 is a right side elevational view of the main body thereof;

FIG. 17 is a rear elevational view of the main body thereof; and,

FIG. 18 is an enlarged sectional view of the main body taken along lines 18—18 in FIG. 15.

The main body in FIGS. 12-18 is shown separate for clarity of illustration, the claim being directed to the entire vacuum cleaner shown in FIGS. 1-11.

1 Claim, 7 Drawing Sheets

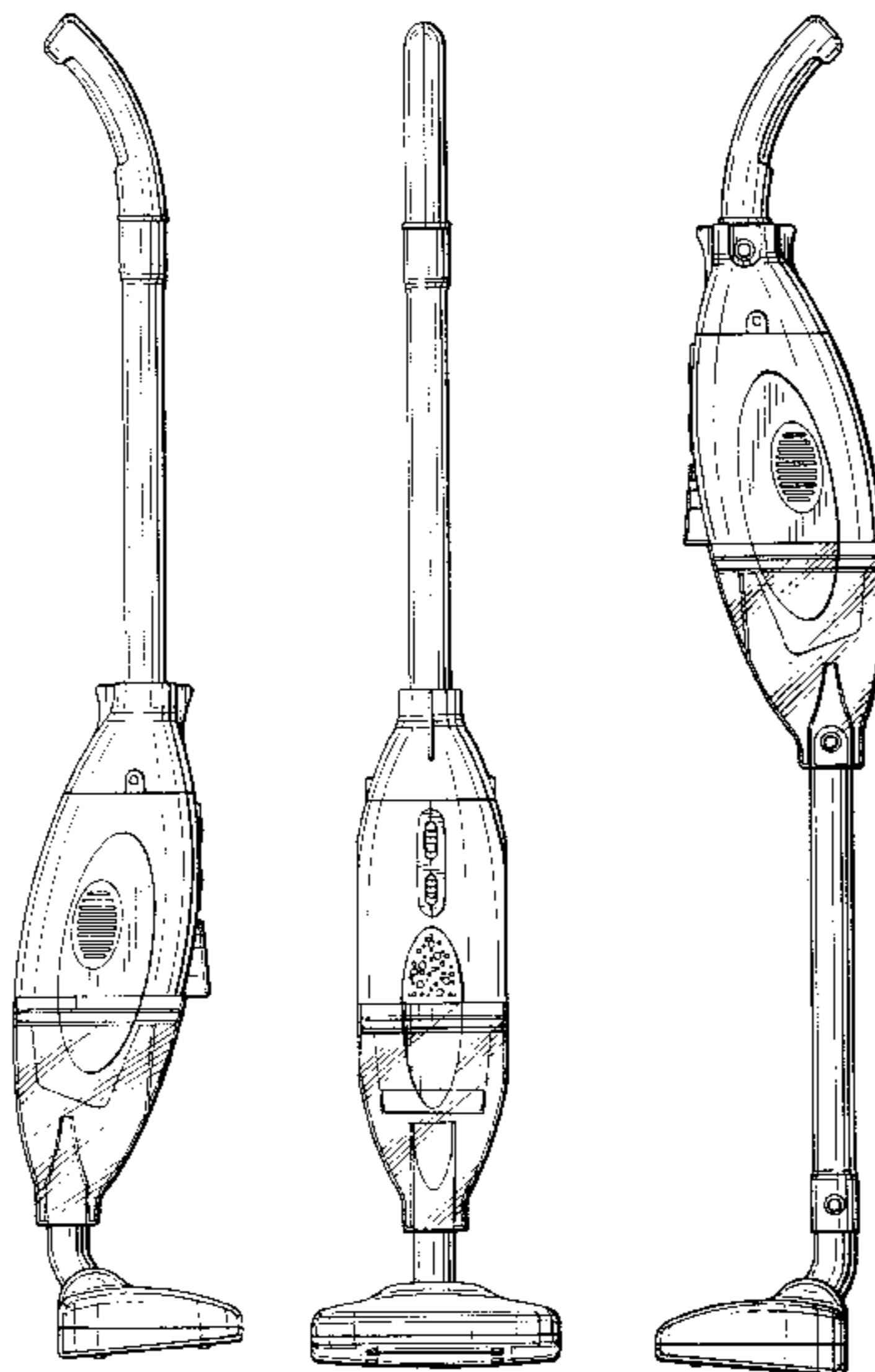

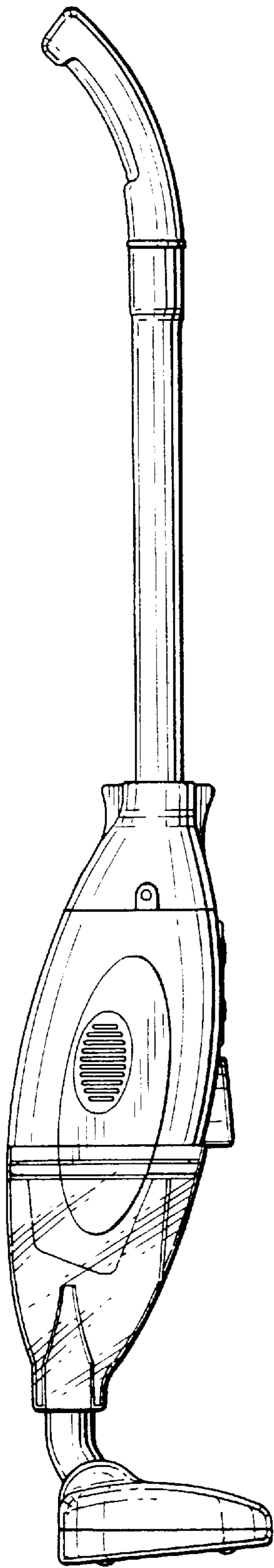

FIG. 1

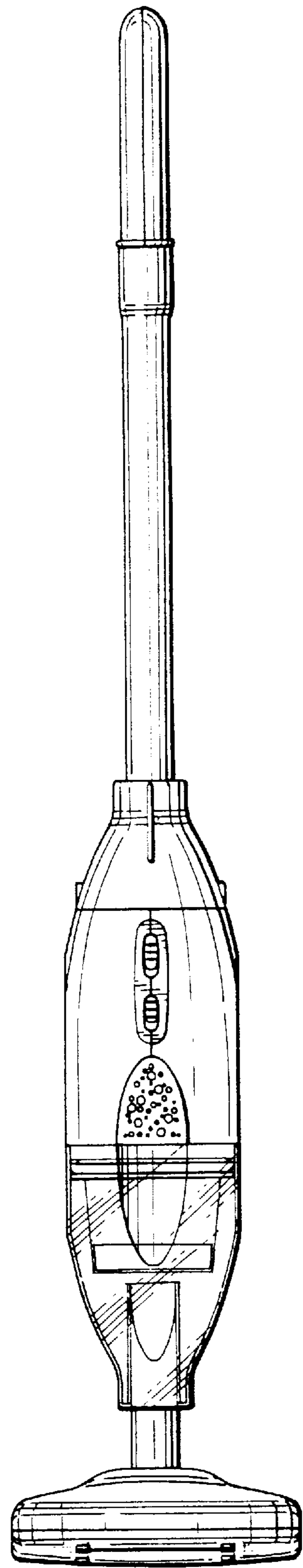

FIG. 2

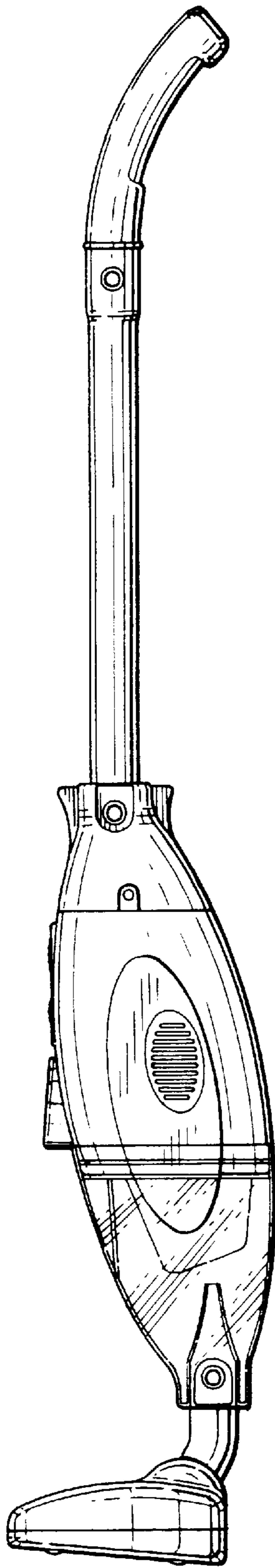

FIG. 3

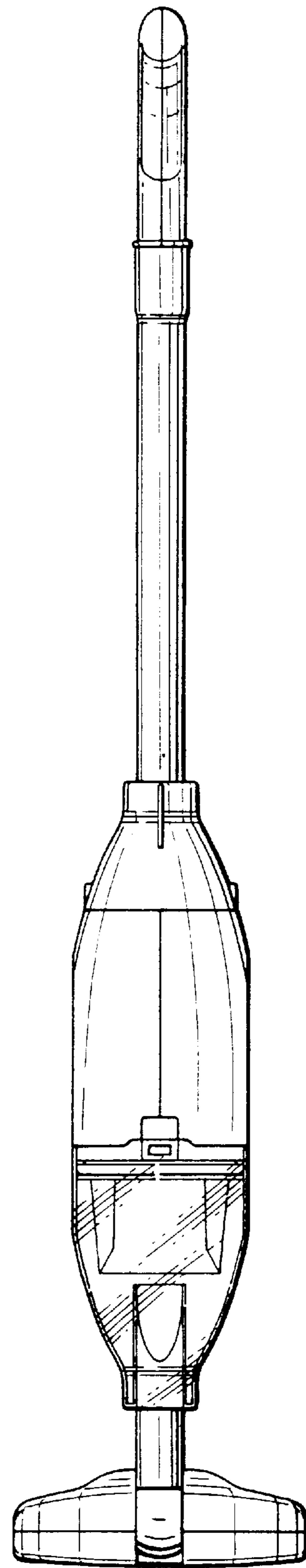

FIG. 4

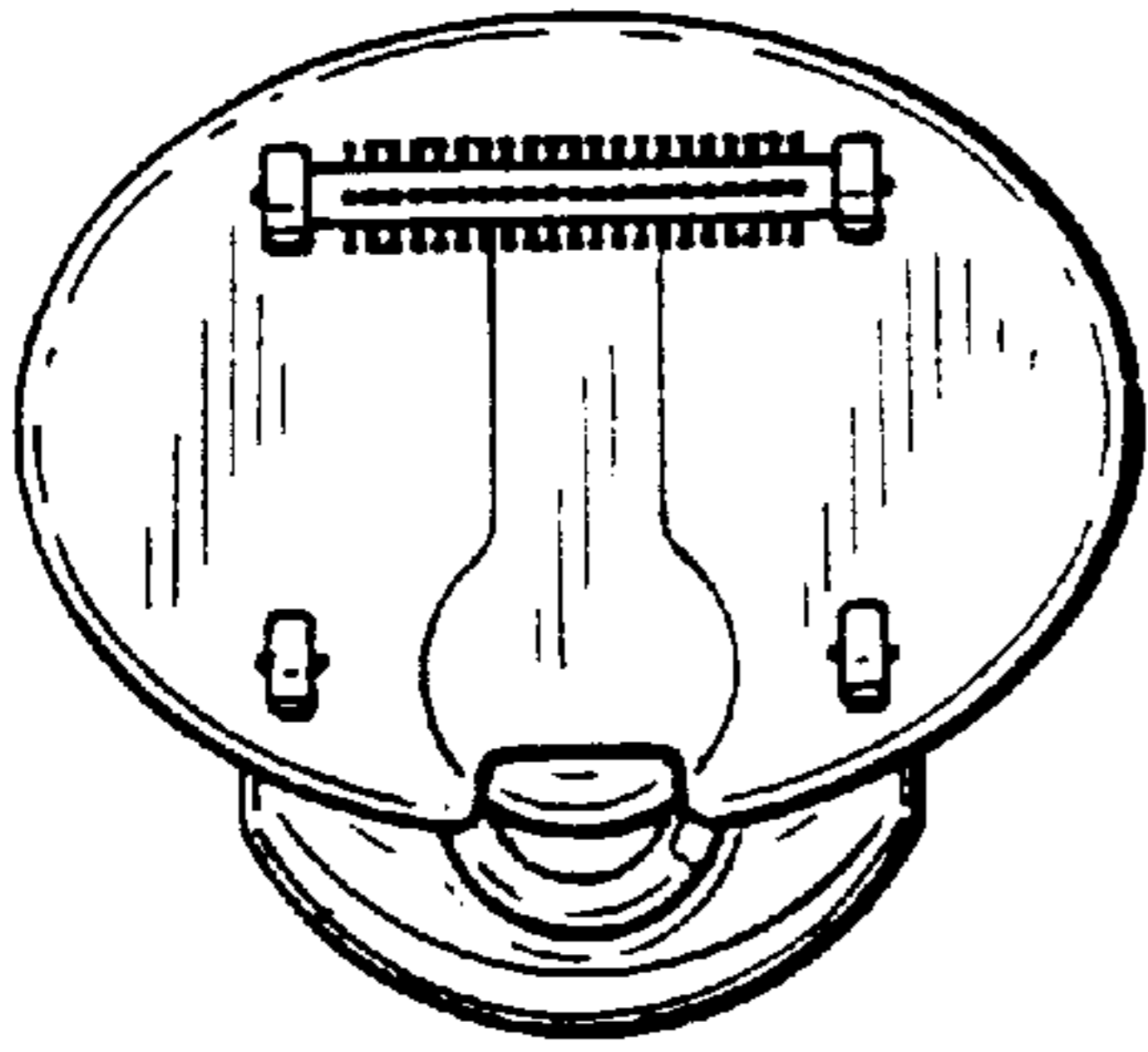

FIG. 5

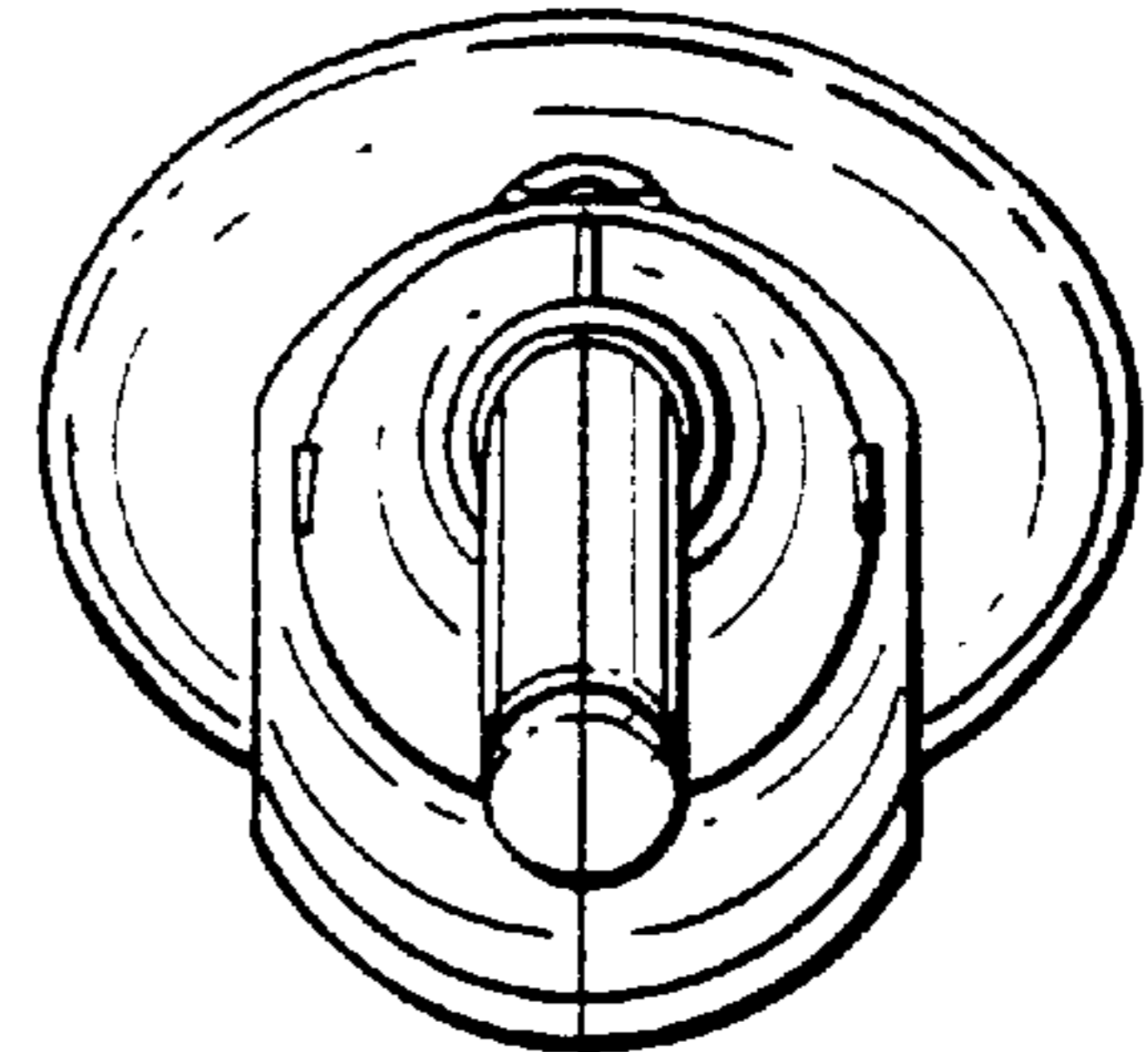

FIG. 6

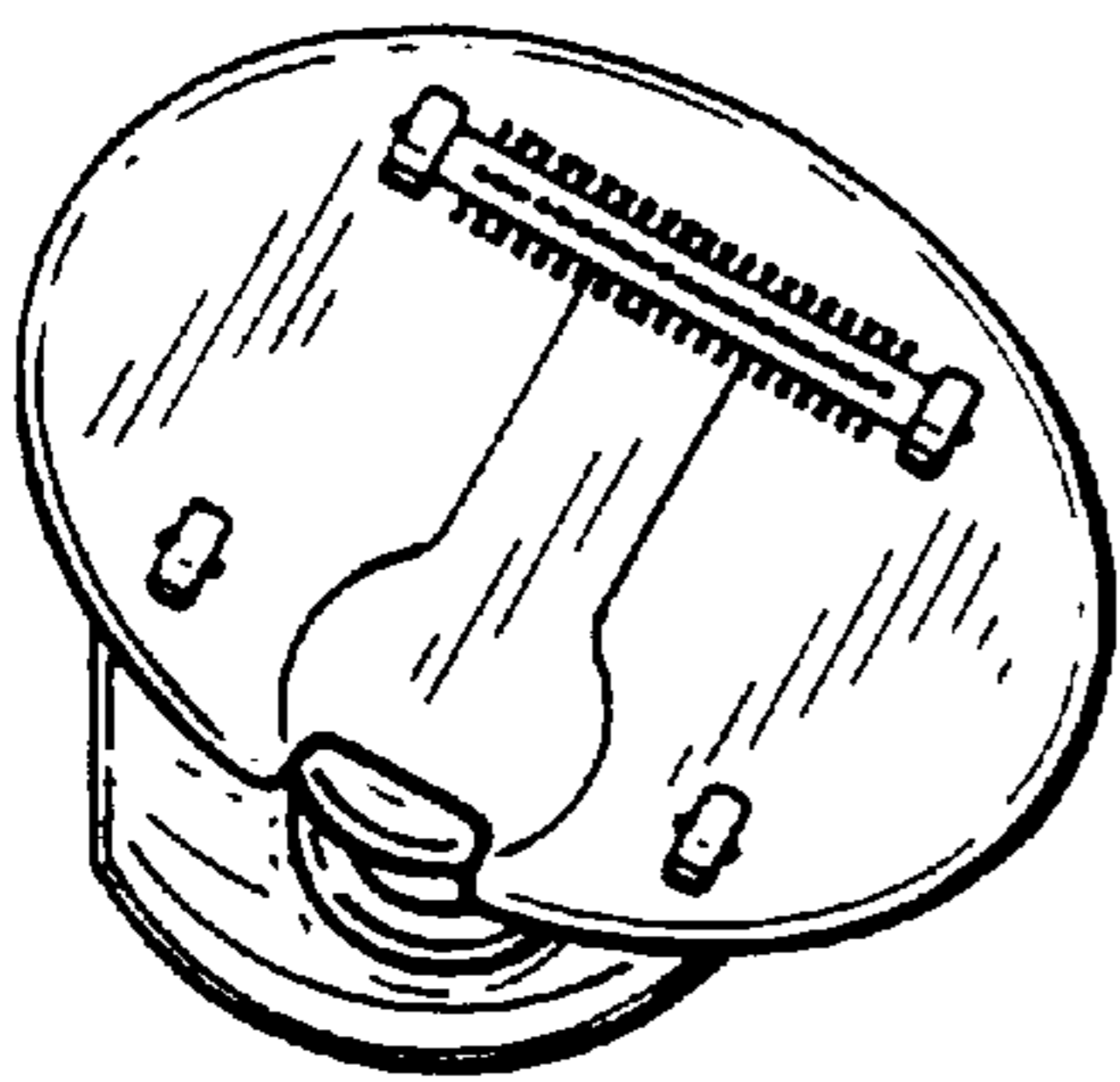

FIG. 7

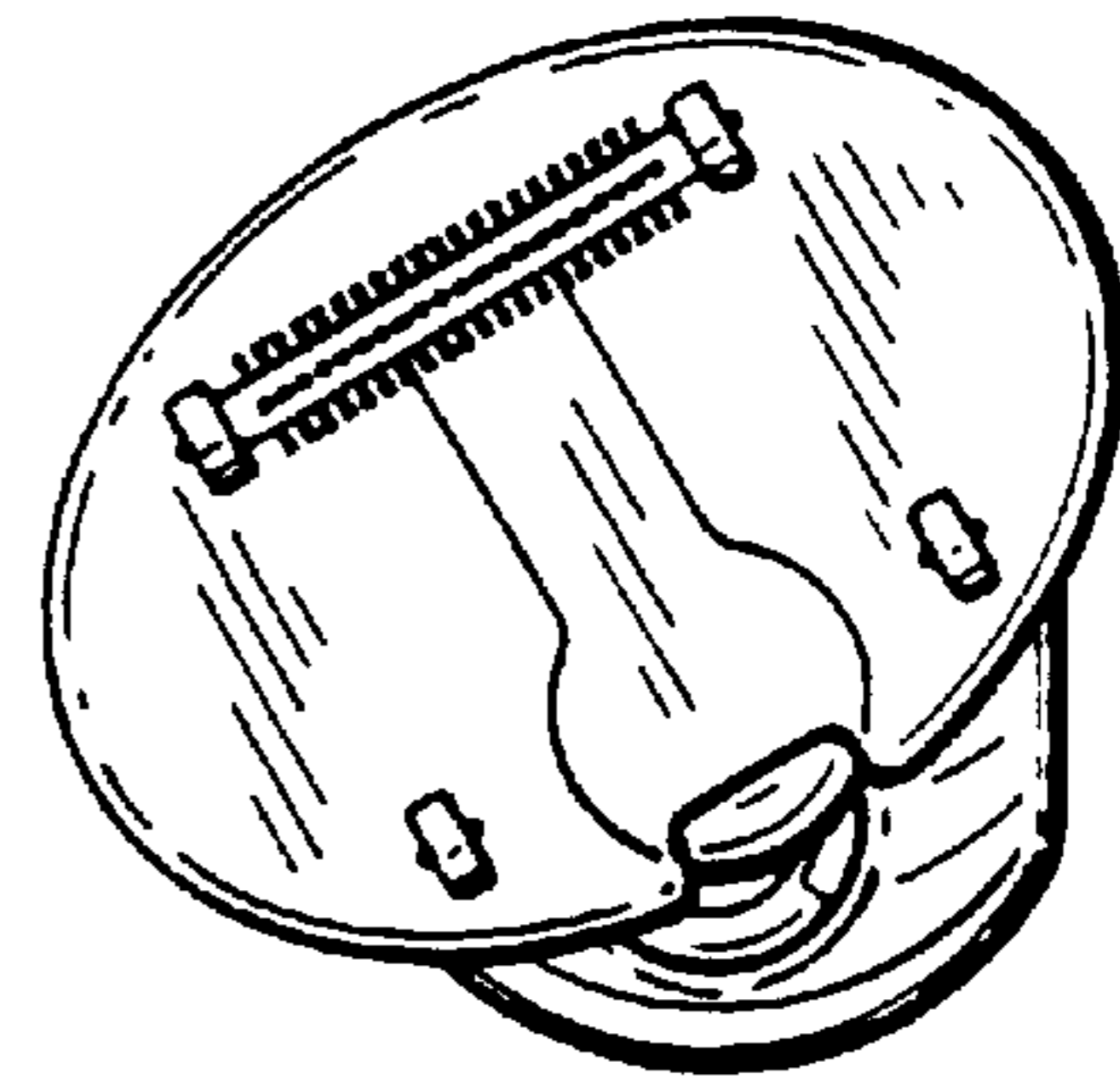

FIG. 8

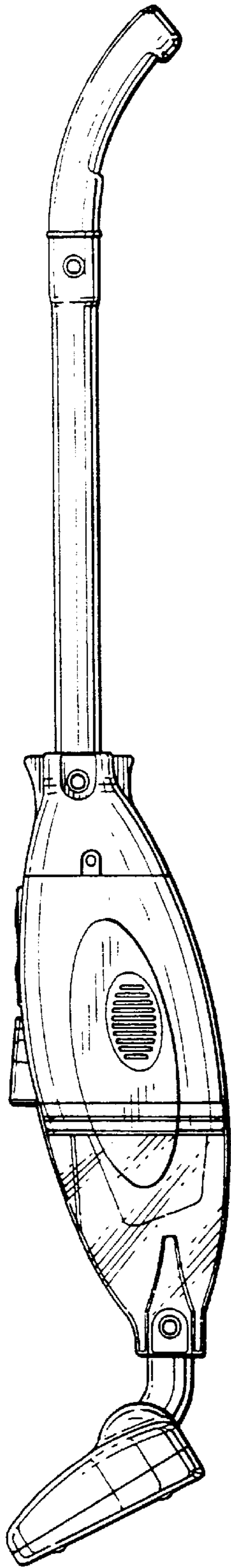

FIG. 9

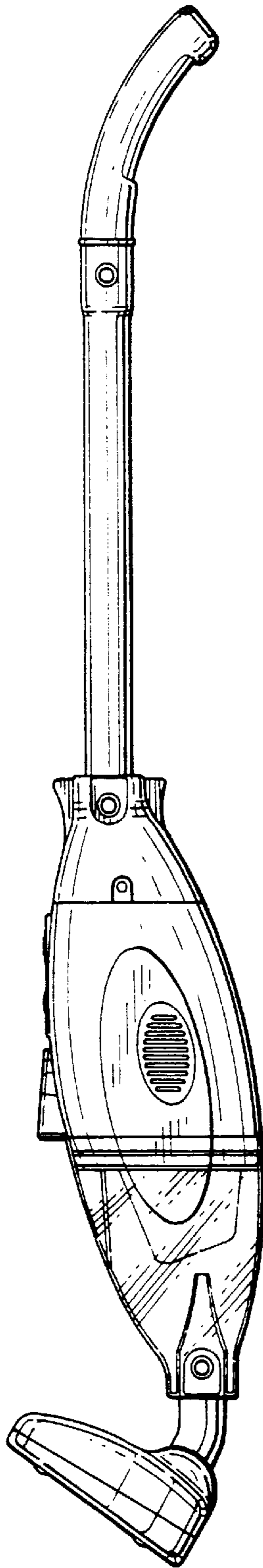

FIG. 10

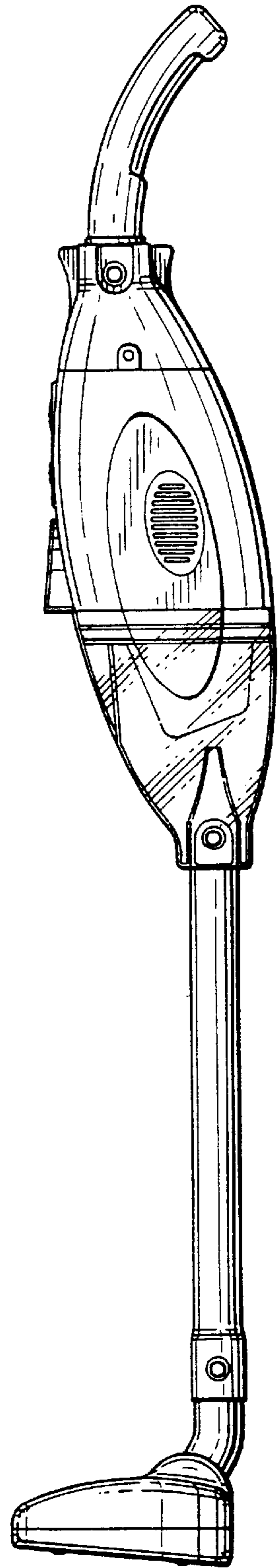

FIG. 11

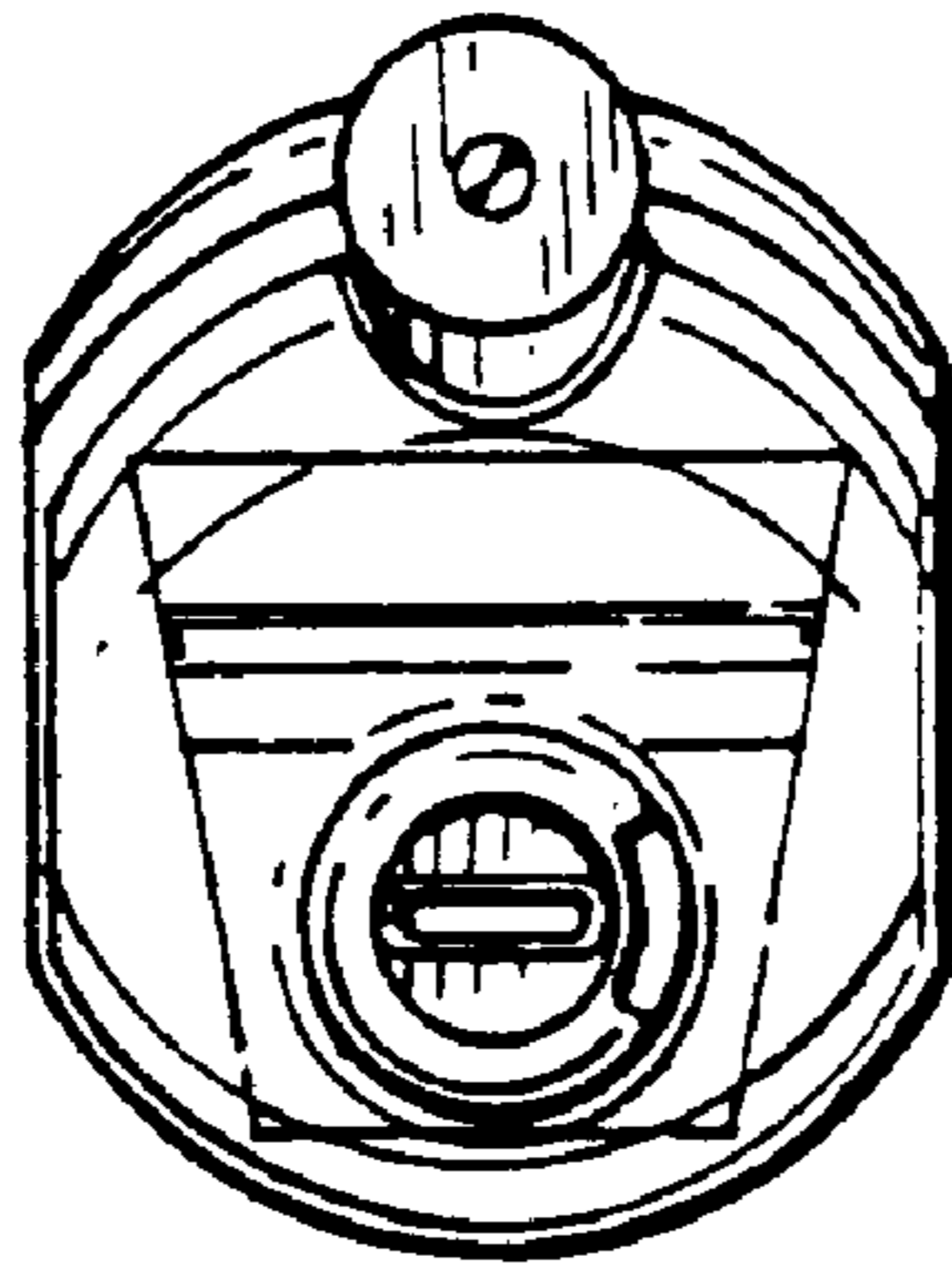

FIG. 12

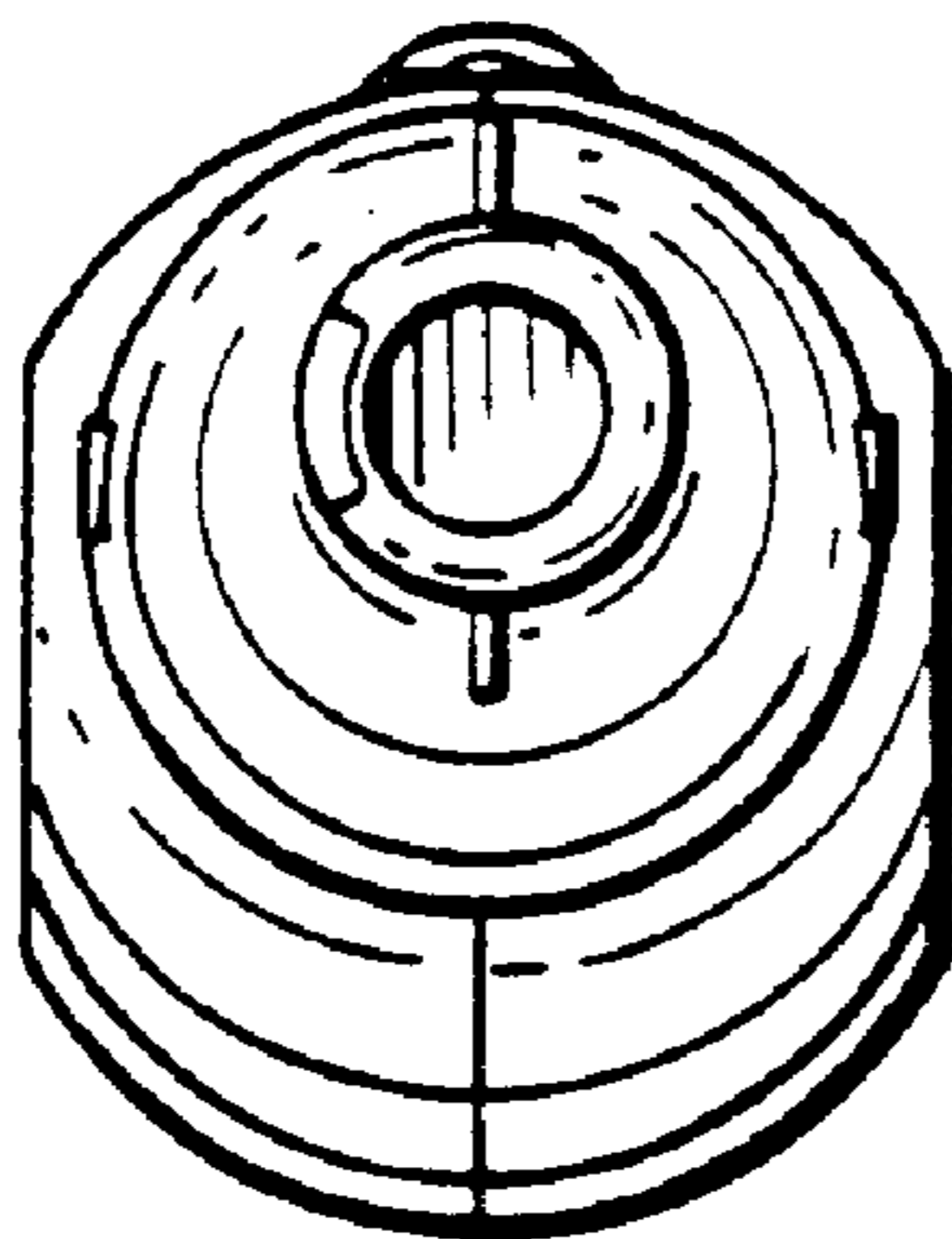

FIG. 13

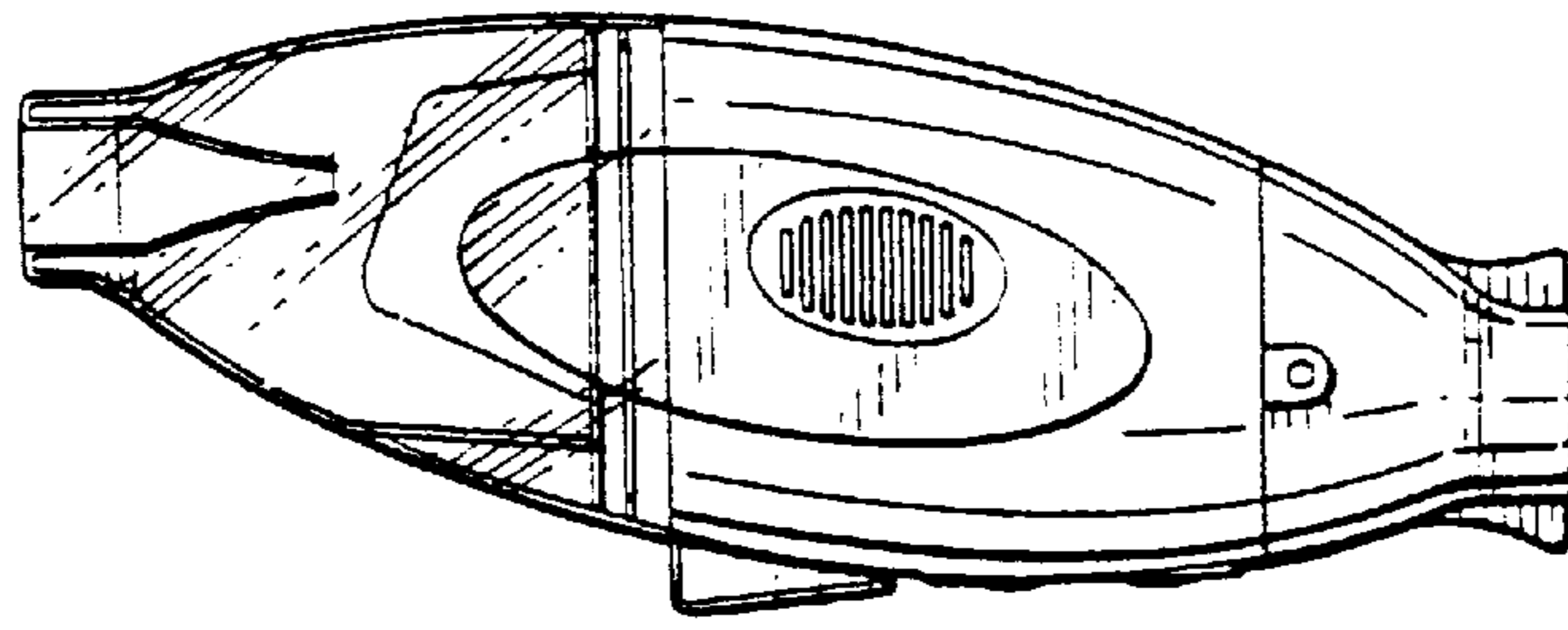

FIG. 14

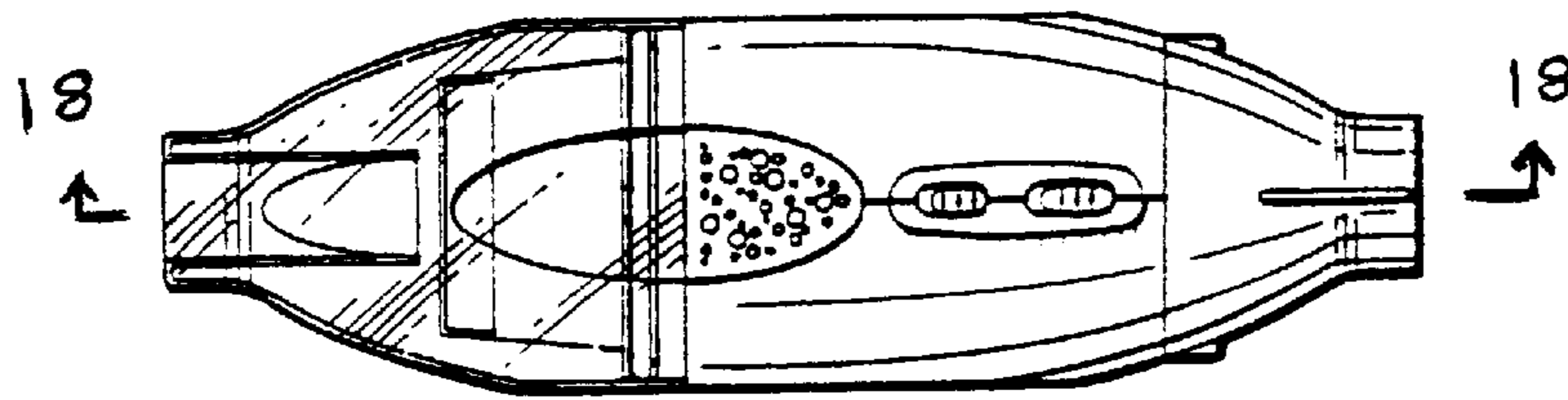

FIG. 15

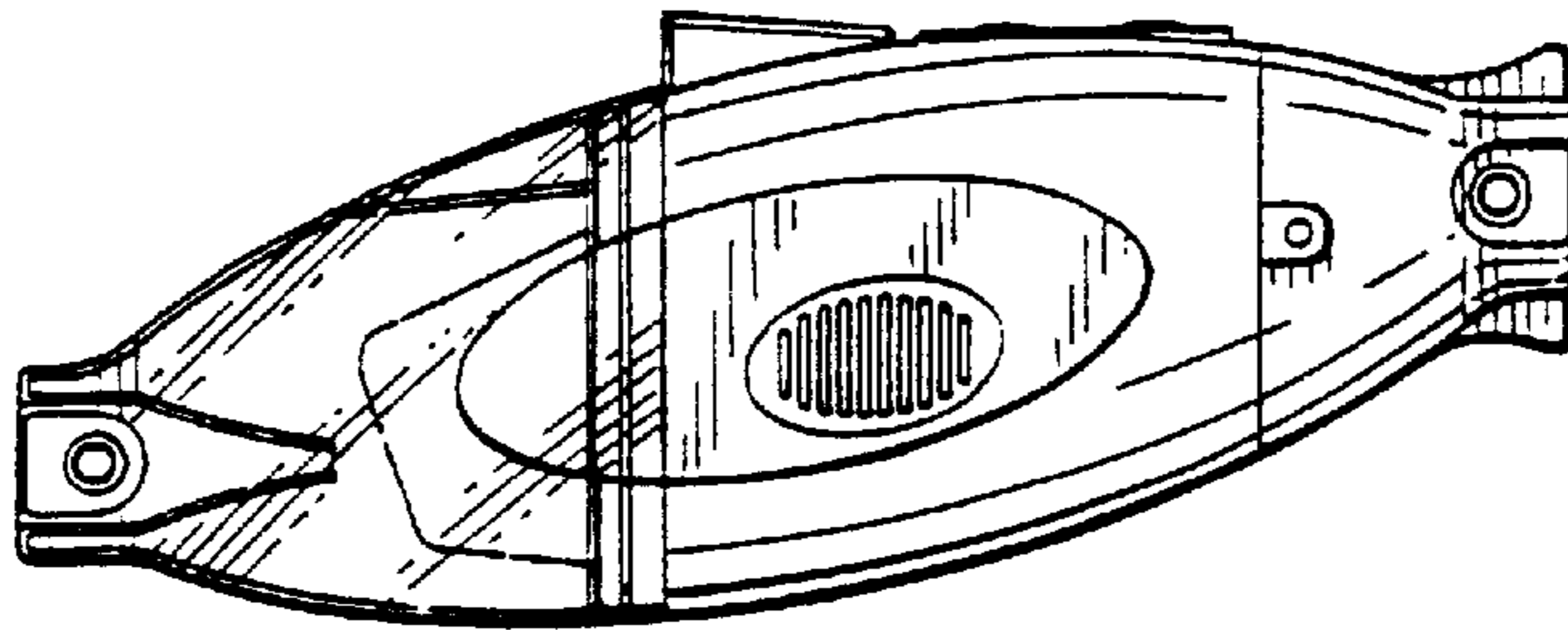

FIG. 16

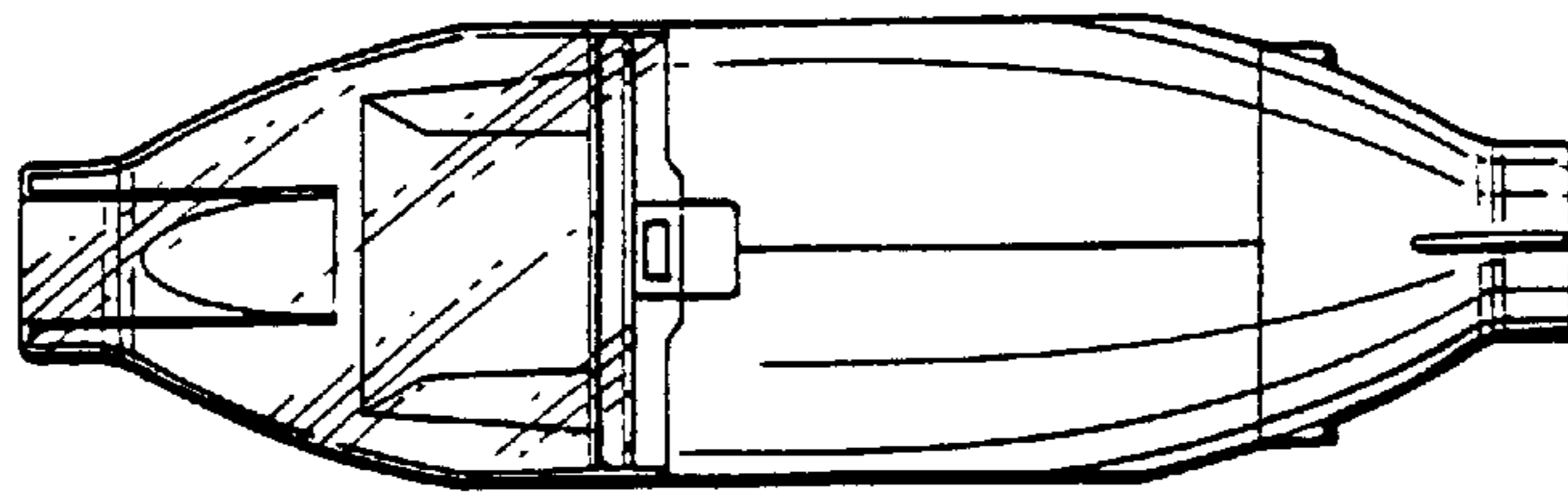

FIG. 17

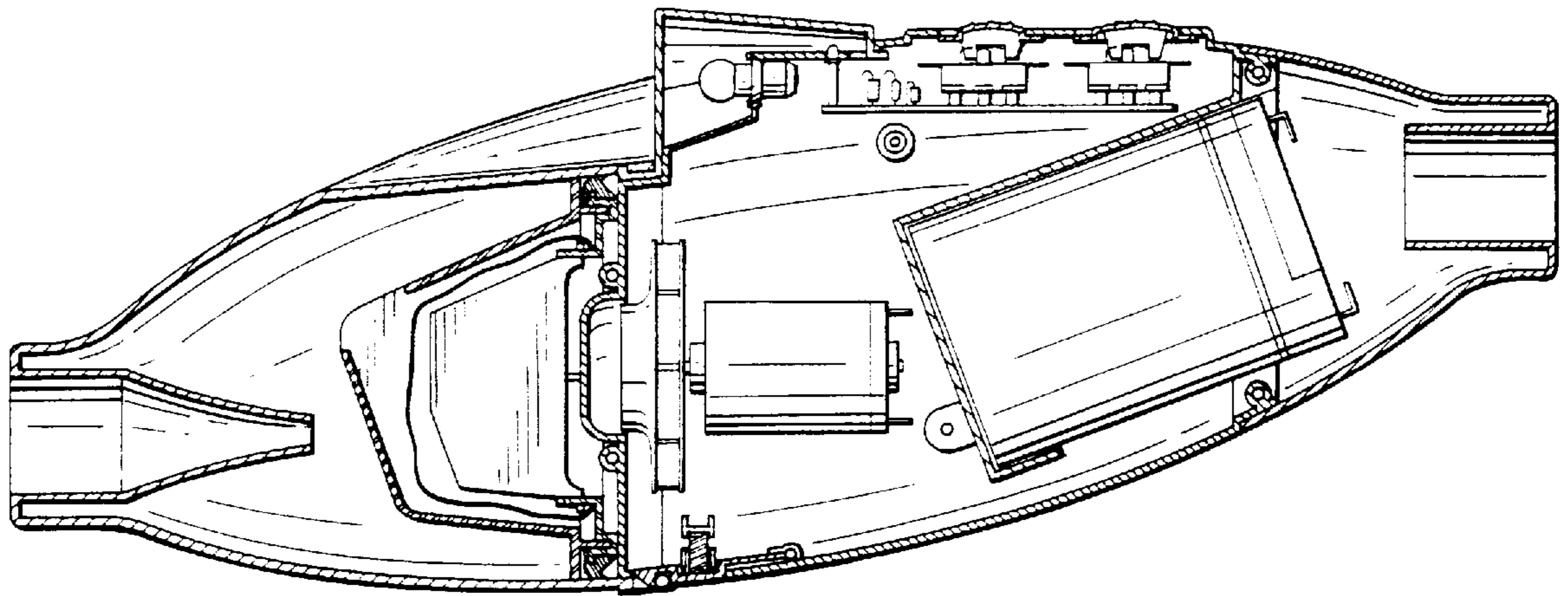

FIG. 18