



US00D420458S

**United States Patent** [19]  
**Guercio**

[11] **Patent Number: Des. 420,458**

[45] **Date of Patent: \*\* Feb. 8, 2000**

[54] **RECTANGULAR FLOOD LIGHT HEAD**

[76] Inventor: **Vincenzo Guercio**, 21 Equestrian Dr.,  
Wallkill, N.Y. 12589

[\*\*] Term: **14 Years**

[21] Appl. No.: **29/088,516**

[22] Filed: **May 26, 1998**

[51] **LOC (7) Cl.** ..... **26-05**

[52] **U.S. Cl.** ..... **D26/63; D26/24**

[58] **Field of Search** ..... **D26/24, 60-66;**  
**362/267, 275, 285, 287, 418, 419, 427**

[56] **References Cited**

**U.S. PATENT DOCUMENTS**

D. 345,226 3/1994 Tsao ..... D26/63  
4,626,975 12/1986 Miletich ..... 362/418

*Primary Examiner*—Susan J. Lucas  
*Attorney, Agent, or Firm*—Baker & Friedman; Thomas A. Beck

[57] **CLAIM**

The ornamental design for a rectangular flood light head, as shown and described.

**DESCRIPTION**

FIG. 1 is an isometric view of the rectangular flood light head;  
FIG. 2 is a side view thereof;  
FIG. 3 is a rear view thereof;  
FIG. 4 is a bottom plan view thereof;  
FIG. 5 is a top plan view thereof;  
FIG. 6 is a left side view thereof (opposite of FIG. 2 above);  
and,  
FIG. 7 is a front view thereof.

**1 Claim, 3 Drawing Sheets**

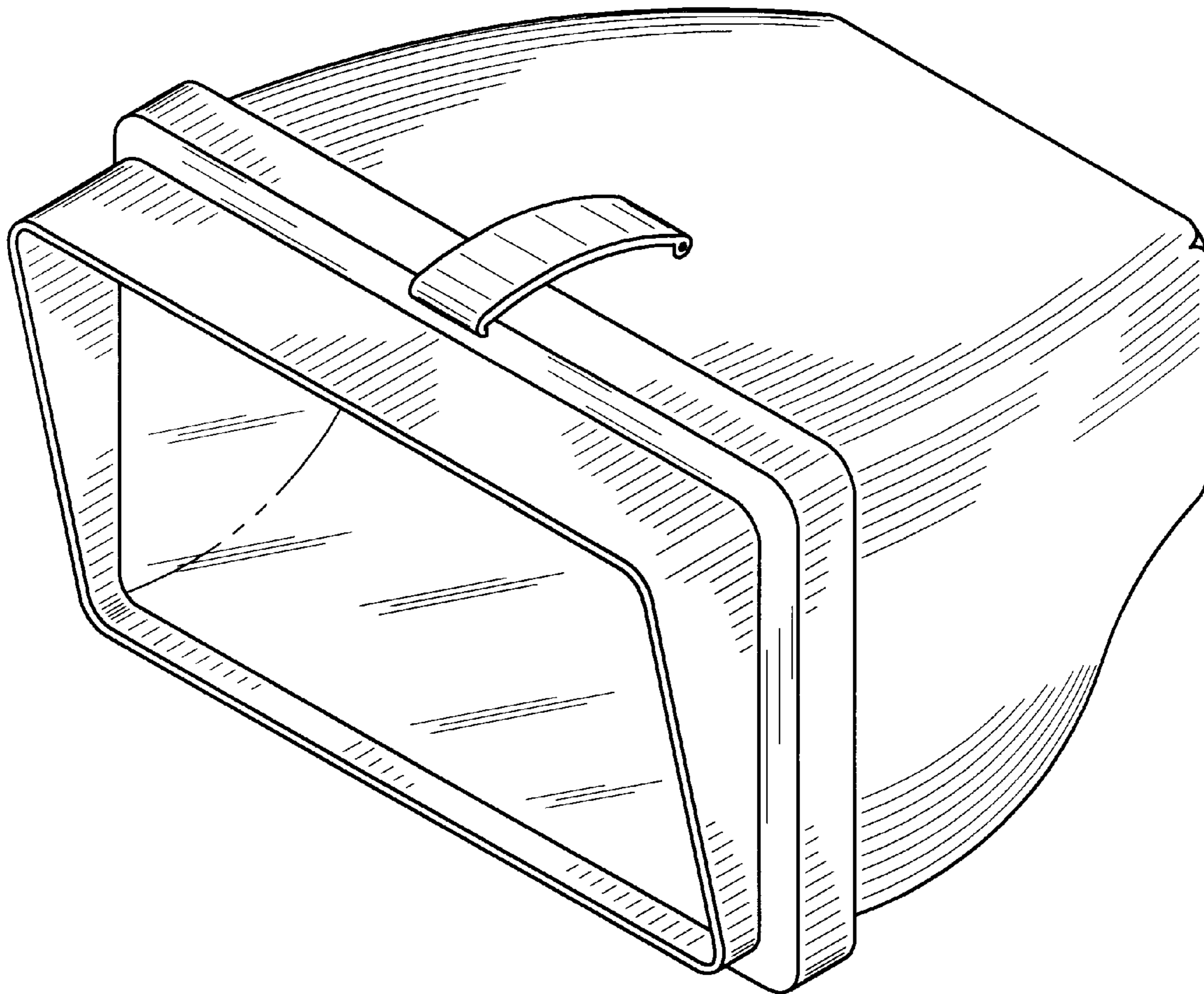

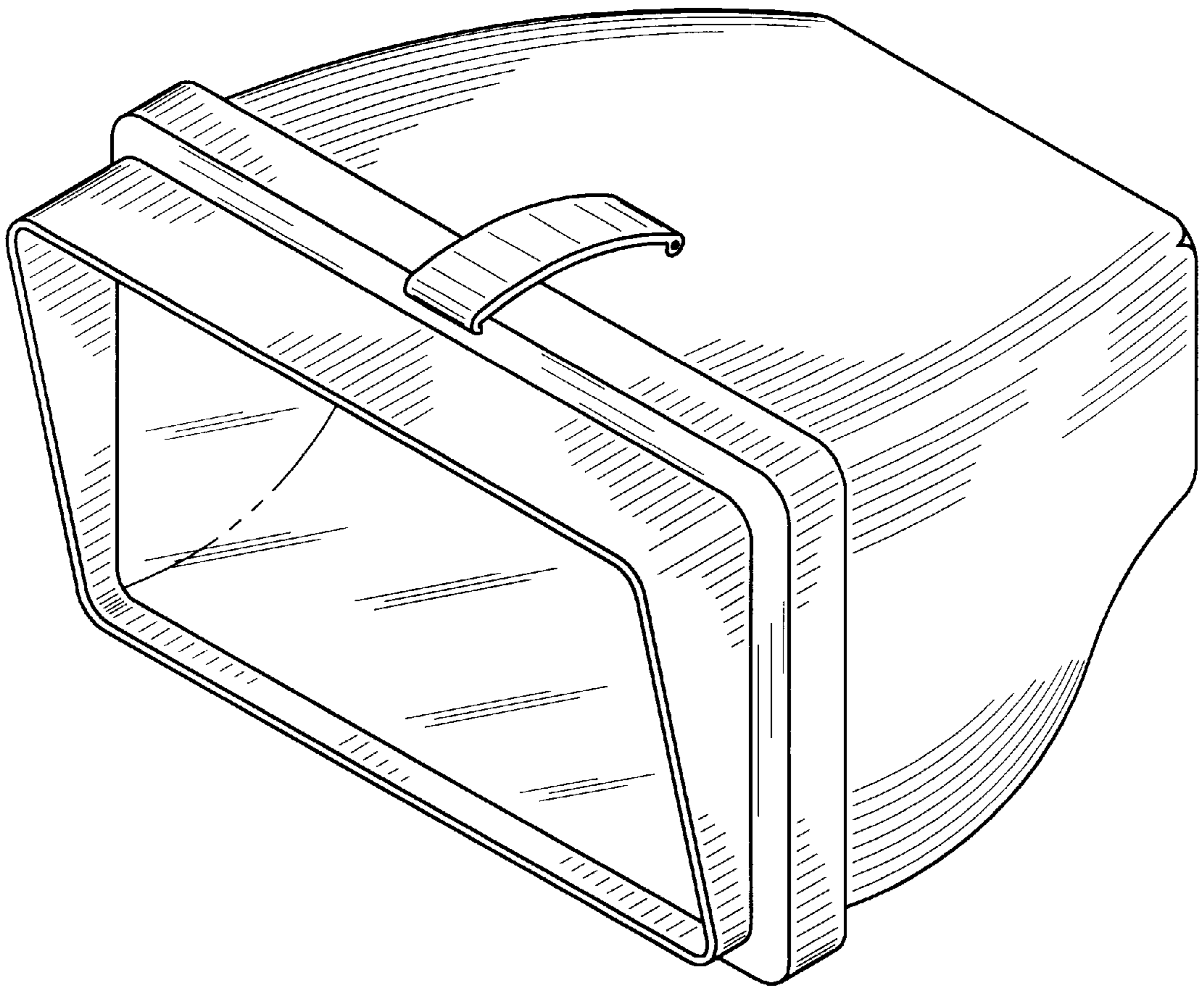

Fig. 1

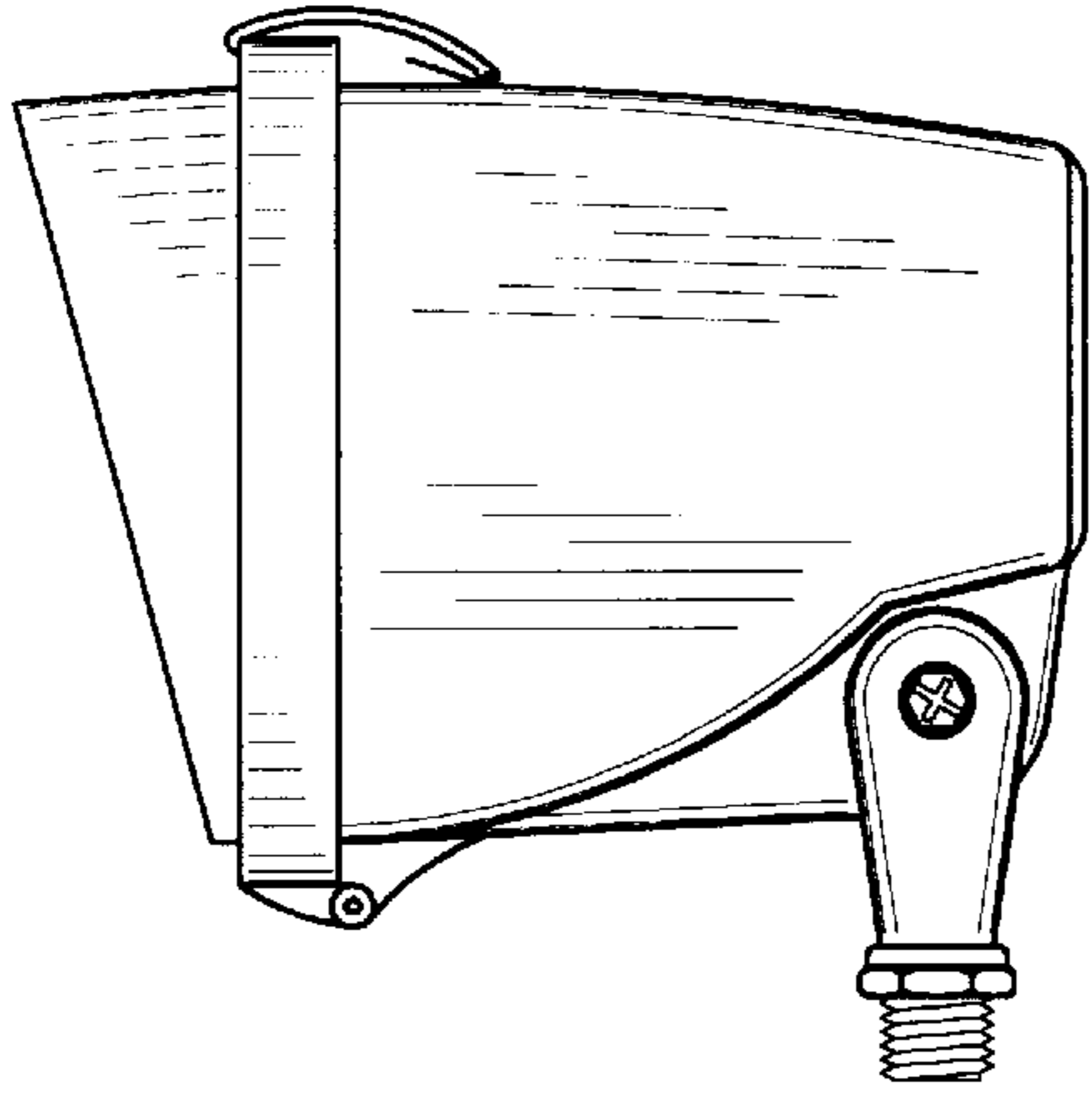

Fig. 2

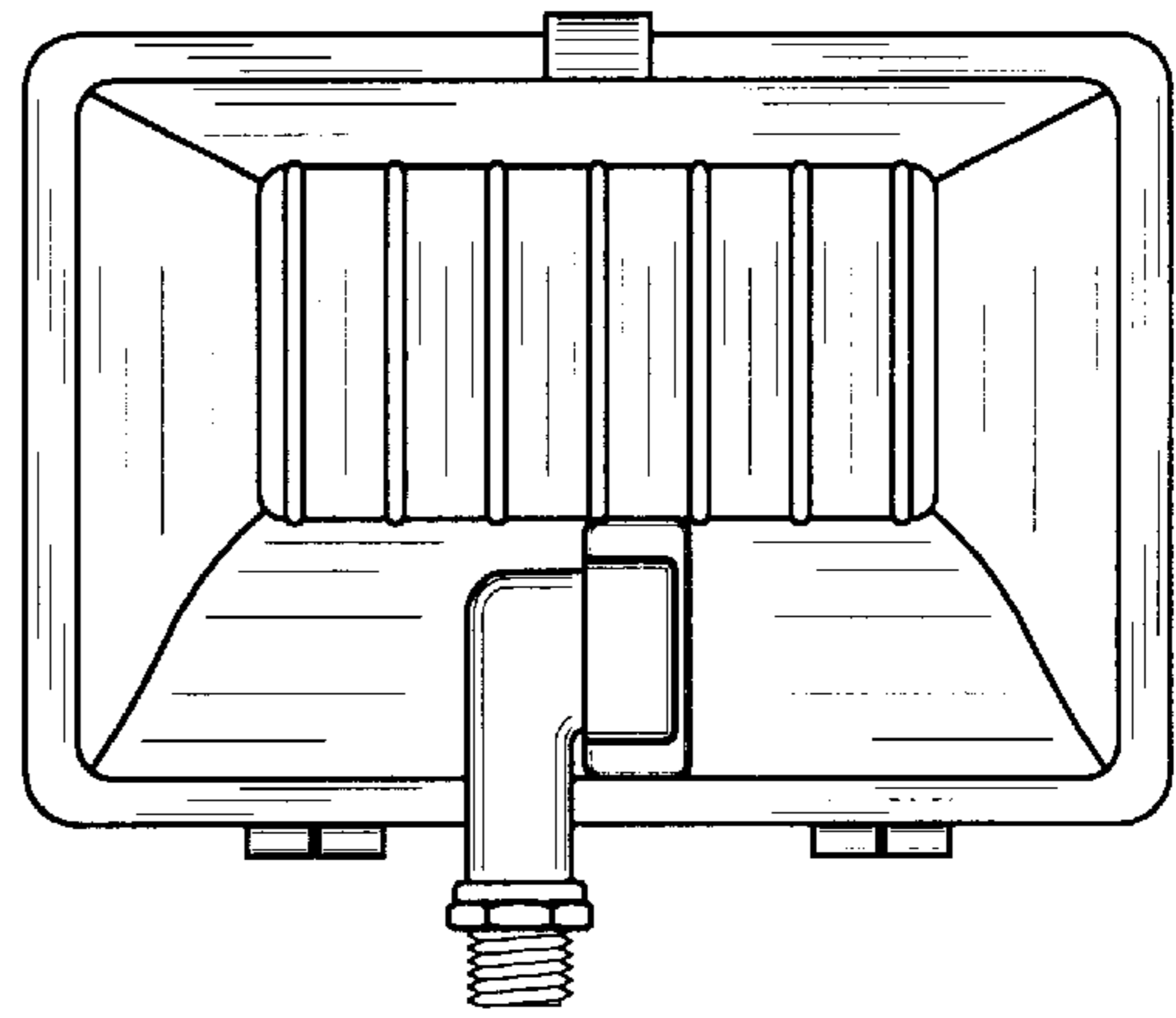

Fig. 3

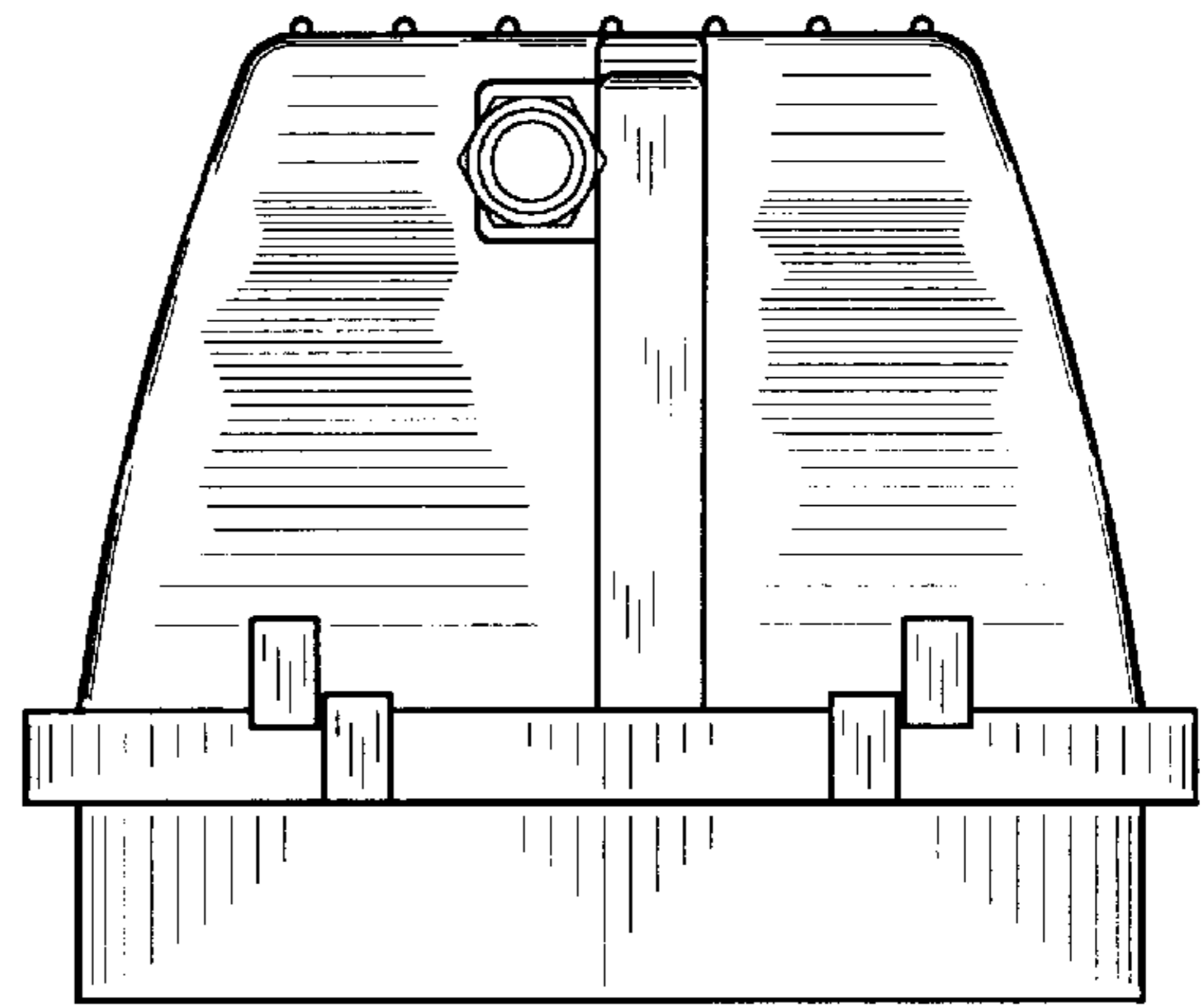

Fig. 4

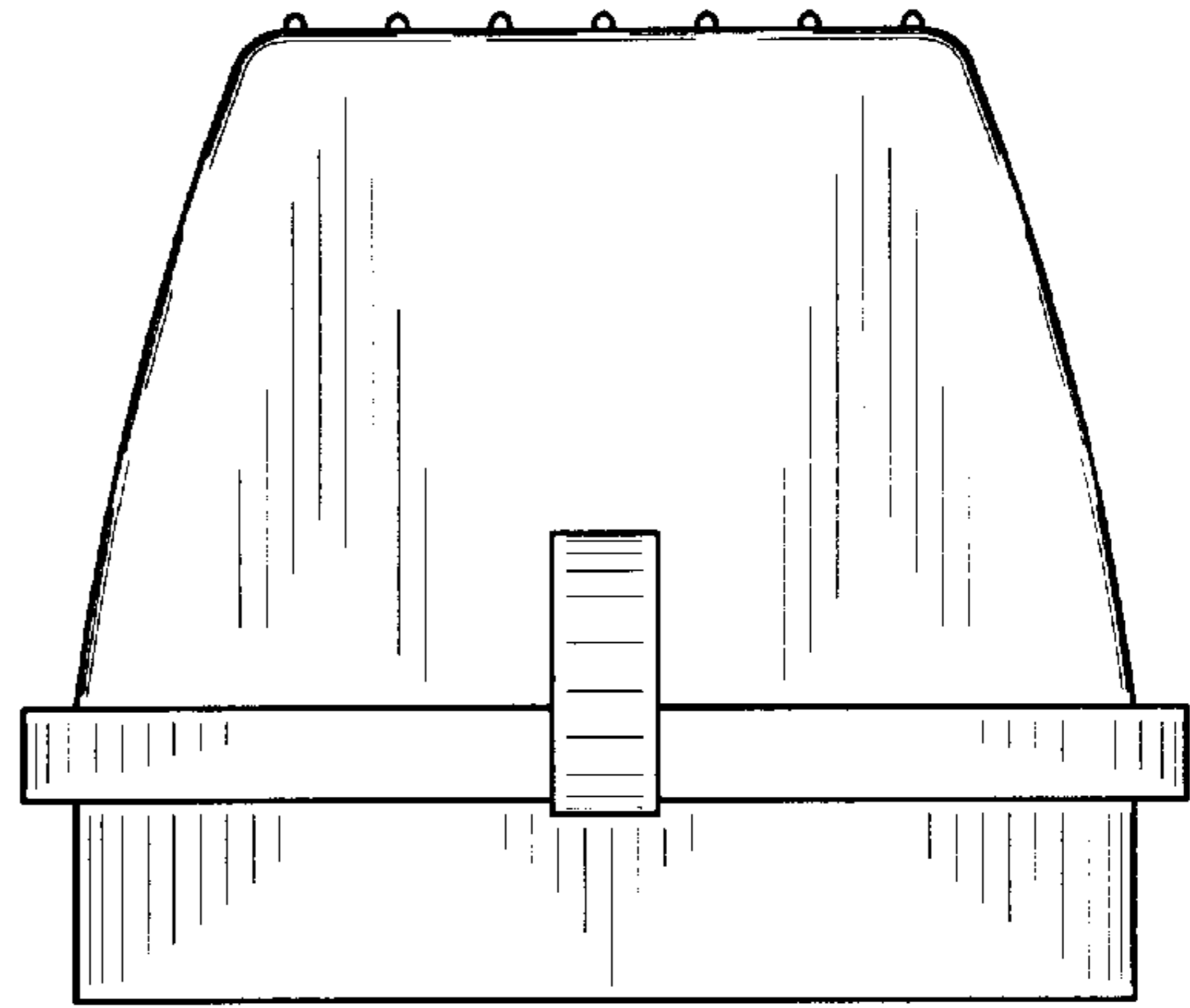

Fig. 5

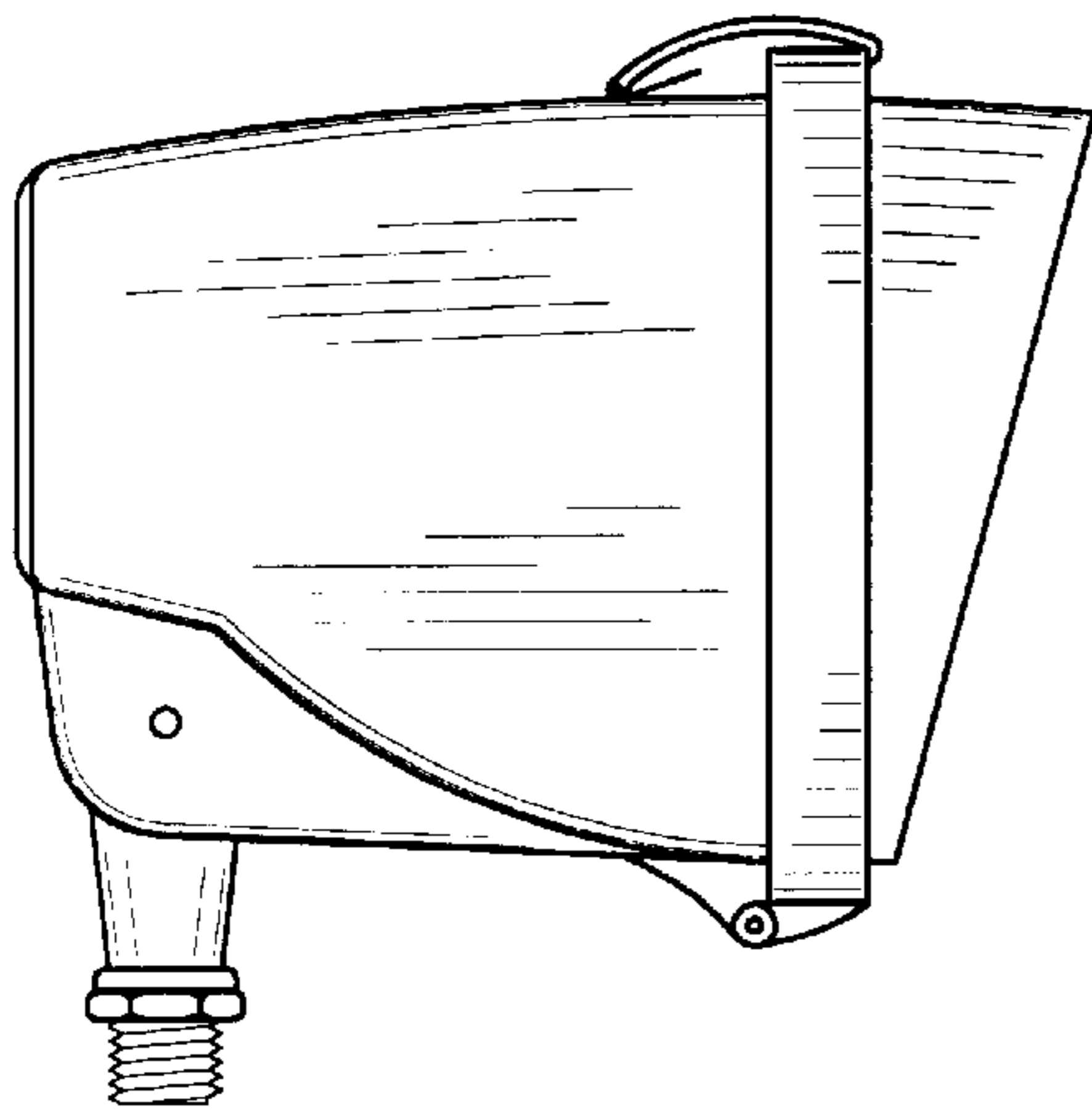

Fig. 6

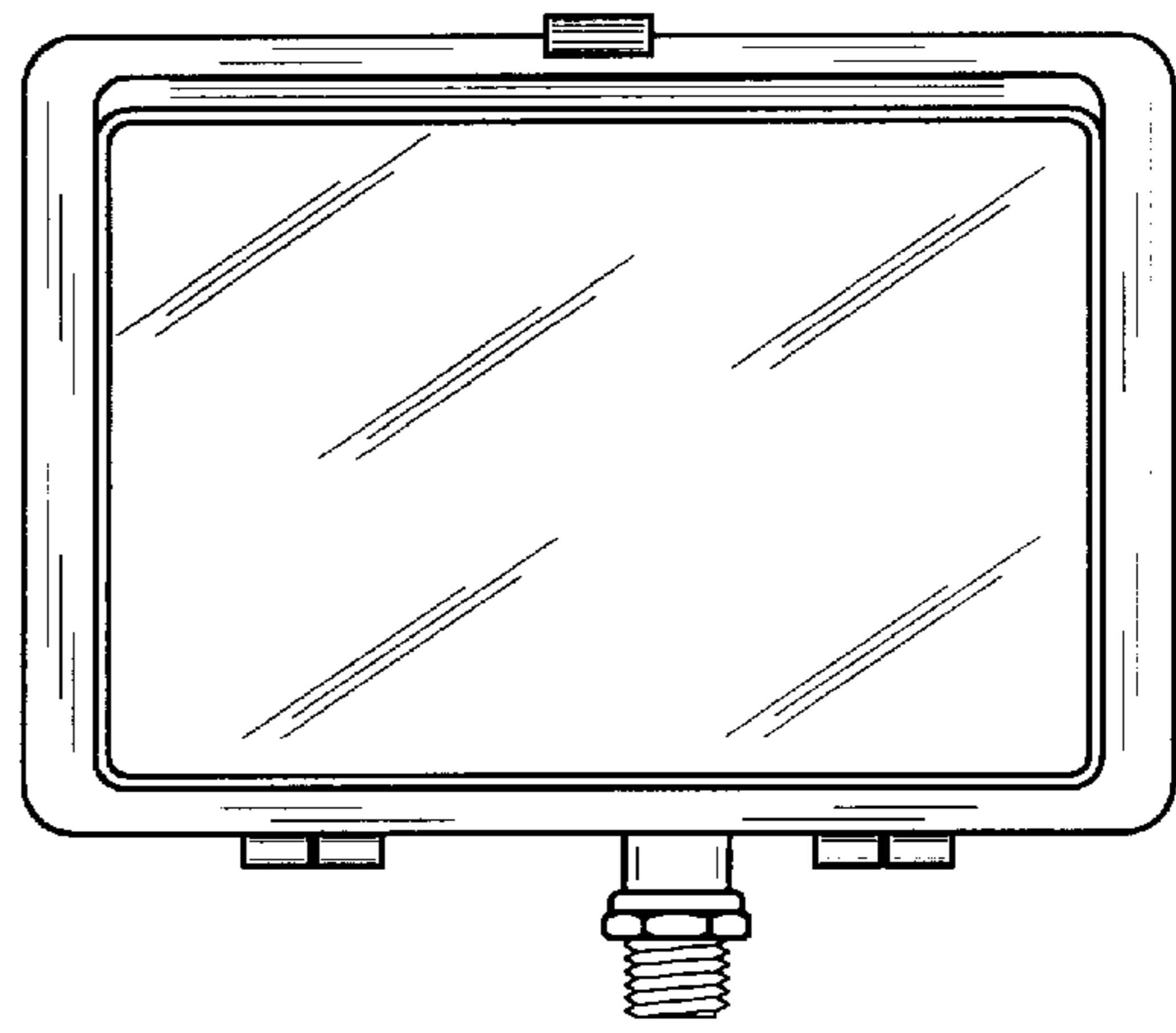

Fig. 7