



US00D420450S

United States Patent [19]

[11] Patent Number: **Des. 420,450**

Anthony et al.

[45] Date of Patent: **** Feb. 8, 2000**

[54] **FOOT MASSAGER**

[75] Inventors: **Michael F. Anthony; Rudy Woodard; Stephen J. Ritch**, all of Nashua, N.H.

[73] Assignee: **Brookstone Company, Inc.**, Nashua, N.H.

[**] Term: **14 Years**

[21] Appl. No.: **29/099,801**

[22] Filed: **Jan. 27, 1999**

[51] **LOC (7) Cl.** **28-03**

[52] **U.S. Cl.** **D24/212**

[58] **Field of Search** D24/212, 213, D24/200; 601/61, 27, 28, 29, 30, 64

4,230,098	10/1980	Uematsu	128/33
4,347,838	9/1982	McCauley	128/33
4,414,963	11/1983	Kunz	128/60
4,860,734	8/1989	Lyu	128/57
4,873,966	10/1989	Gitter	128/33
5,063,911	11/1991	Teranishi	128/32
5,099,826	3/1992	Hayakawa	128/36
5,183,034	2/1993	Yamasaki et al.	128/36
5,305,738	4/1994	Shimizu	601/35
5,437,607	8/1995	Taylor	601/49
5,785,668	7/1998	Shimizu	60/187

FOREIGN PATENT DOCUMENTS

6096252	5/1985	Japan	A61H 7/00
26041	1/1990	Japan	A61H 23/02
426420	1/1992	Japan	A61H 23/02
549666	3/1993	Japan	A61H 23/02
5184639	7/1993	Japan	A61H 23/02
9517872	1/1994	Japan	A61H 23/02

[56] References Cited

U.S. PATENT DOCUMENTS

D. 242,826	12/1976	Posh et al.	D83/1 S
D. 253,967	1/1980	Miyadai	D24/36
D. 254,507	3/1980	Redding	D24/36
D. 254,869	4/1980	Osburn	D24/36
D. 255,835	7/1980	Bentsen	D24/36
D. 256,503	8/1980	Moustakas	D24/36
D. 269,636	7/1983	MacGregor et al.	D24/212
D. 271,420	11/1983	Sierra	D24/36
D. 280,934	10/1985	MacGregor	D24/212
D. 330,256	10/1992	Wollman	D24/213
D. 339,638	9/1993	Bucher	D24/212
D. 367,931	3/1996	Shimizu	D24/212
2,781,040	2/1957	Hill	.
2,934,062	4/1960	Klassen et al.	.
2,964,037	12/1960	Johnston	.
3,570,478	3/1971	Schneider	128/57
3,830,232	8/1974	McNair	601/64
3,942,520	3/1976	McNair	128/24
4,010,743	3/1977	Fitzsimons	128/57
4,014,325	3/1977	Clarke	128/57
4,057,053	11/1977	Kunz	128/25
4,109,649	8/1978	Iyomasa	128/57
4,184,488	1/1980	Bielich	128/66
4,198,962	4/1980	McCauley	128/33

OTHER PUBLICATIONS

Unknown, Hammacher Schlemmer Magazine, 1992, 46-48, Hammacher Sclemmer & Co., Inc.
Unknown, The Sharper Image Catalog, Jun. 1993, Unknown Page Number, The Sharper Image Catalog.

Primary Examiner—Stella Reid
Attorney, Agent, or Firm—Hayes Soloway Hennessey Grossman & Hage PC

[57] CLAIM

I claim the ornamental design for a foot massager, as shown and described.

DESCRIPTION

FIG. 1 is a perspective view.
FIG. 2 is a top view.
FIG. 3 is a bottom view.
FIG. 4 is a front view.
FIG. 5 is a rear view; and,
FIG. 6 is a right side view, the left side being mirror image thereof.

1 Claim, 6 Drawing Sheets

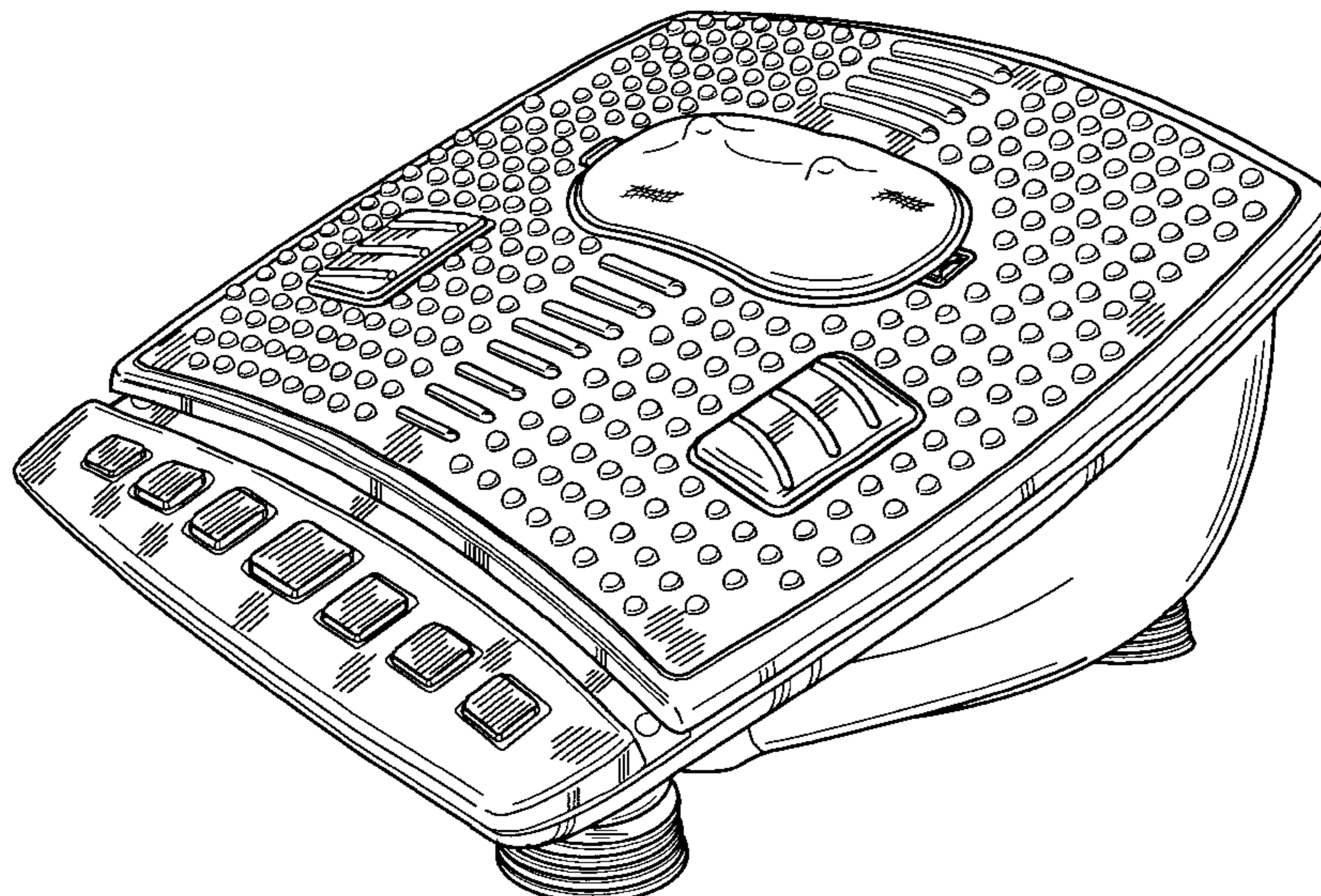

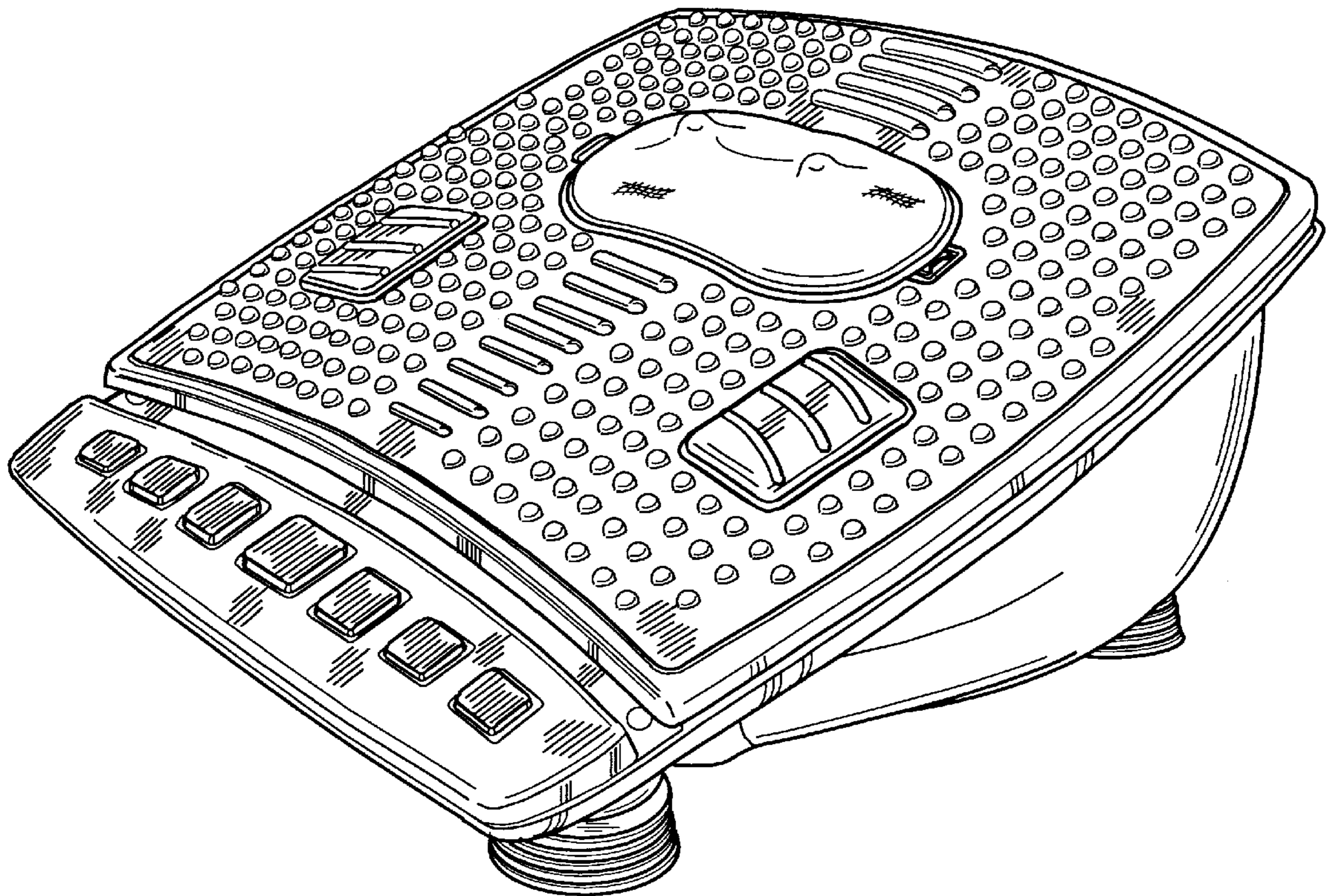

FIG. 1

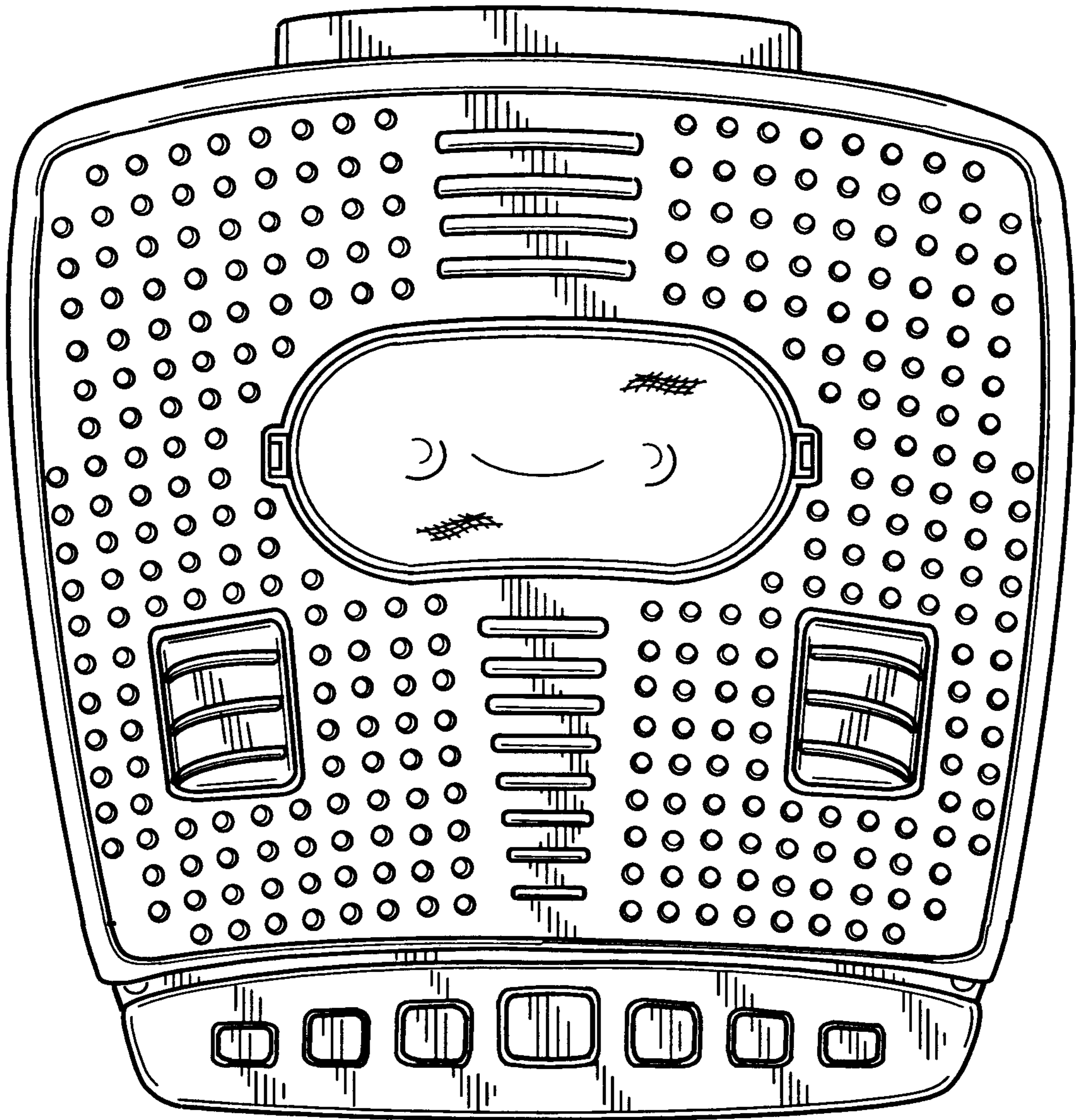

FIG. 2

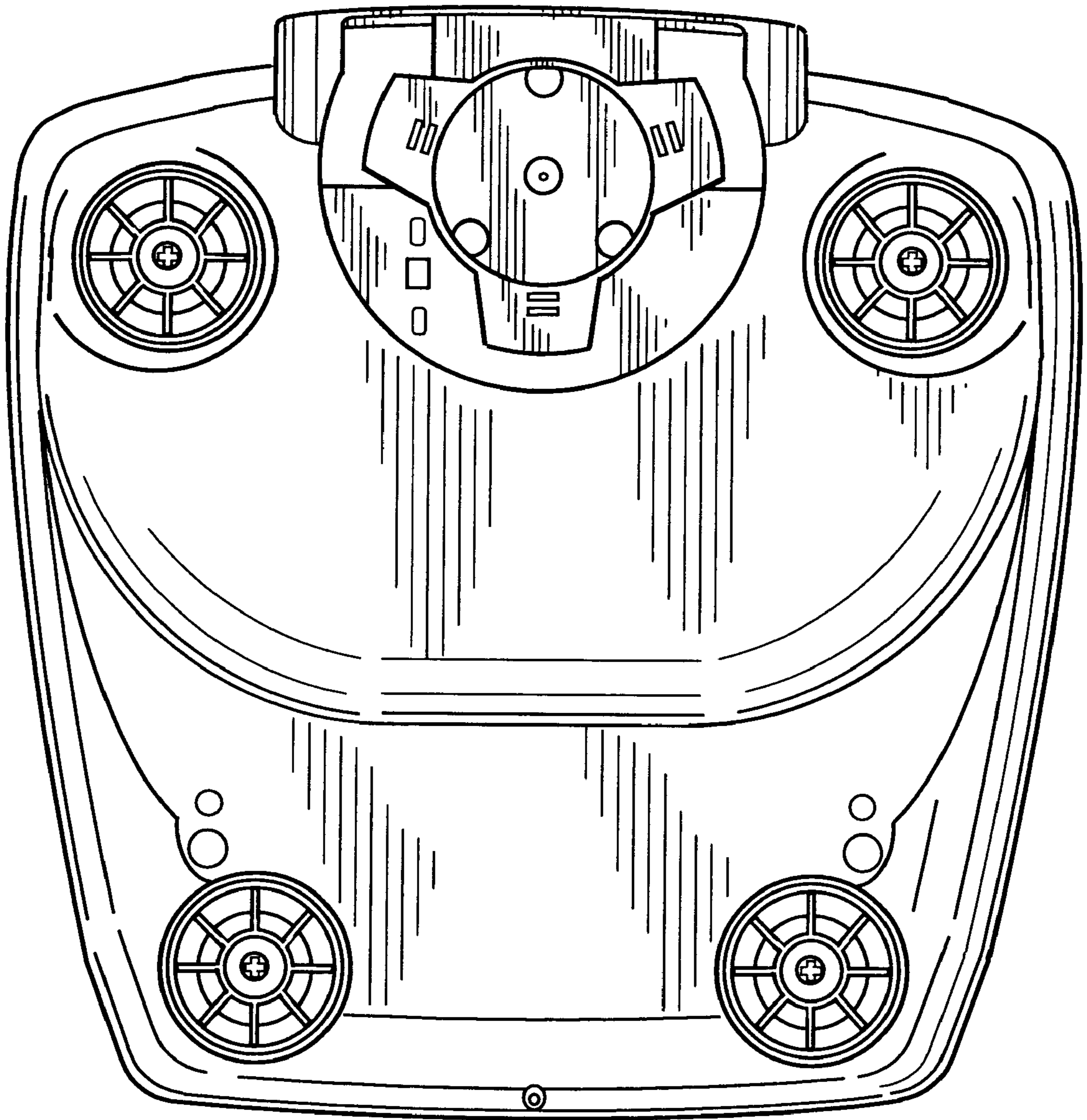

FIG. 3

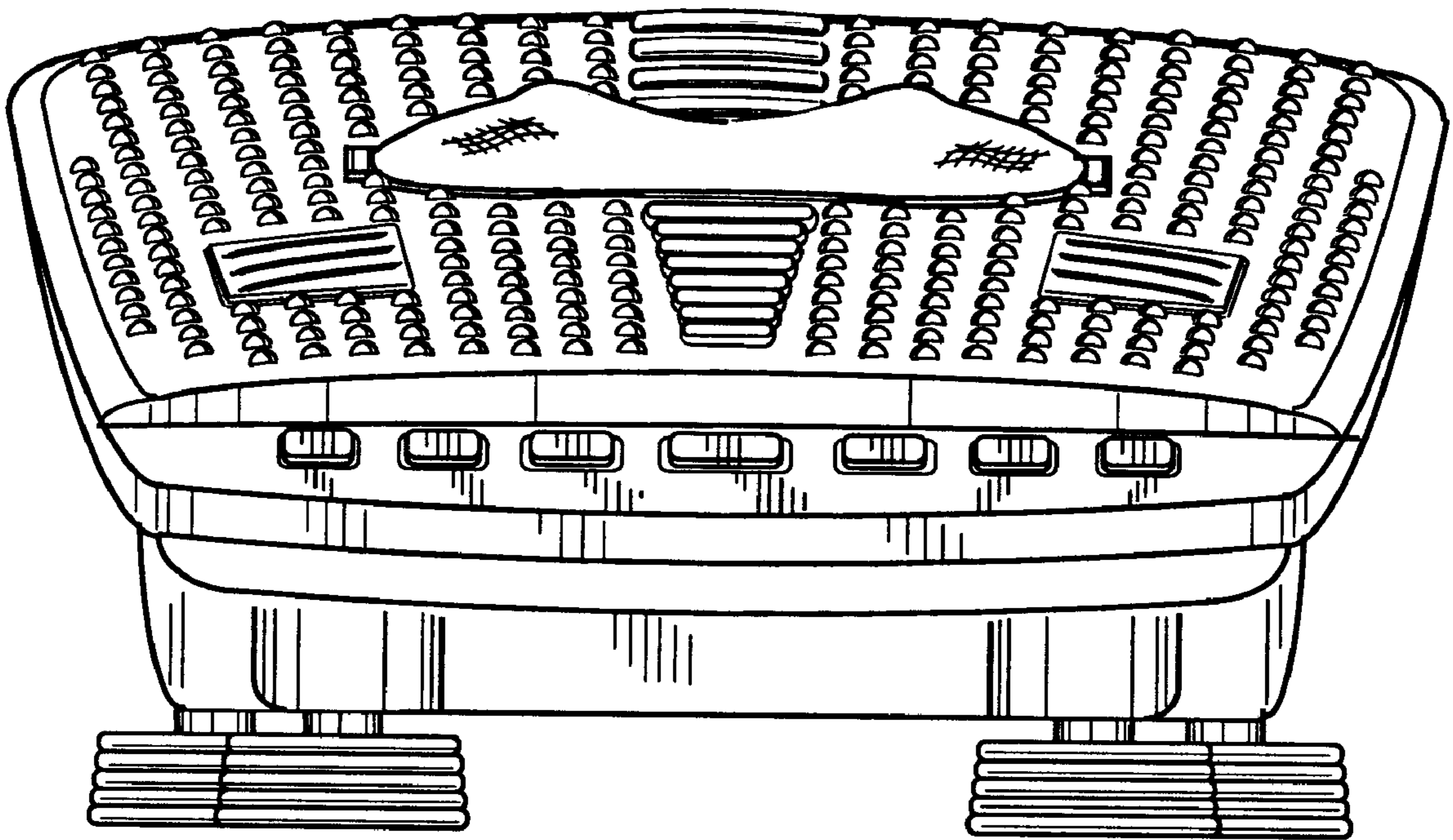

FIG. 4

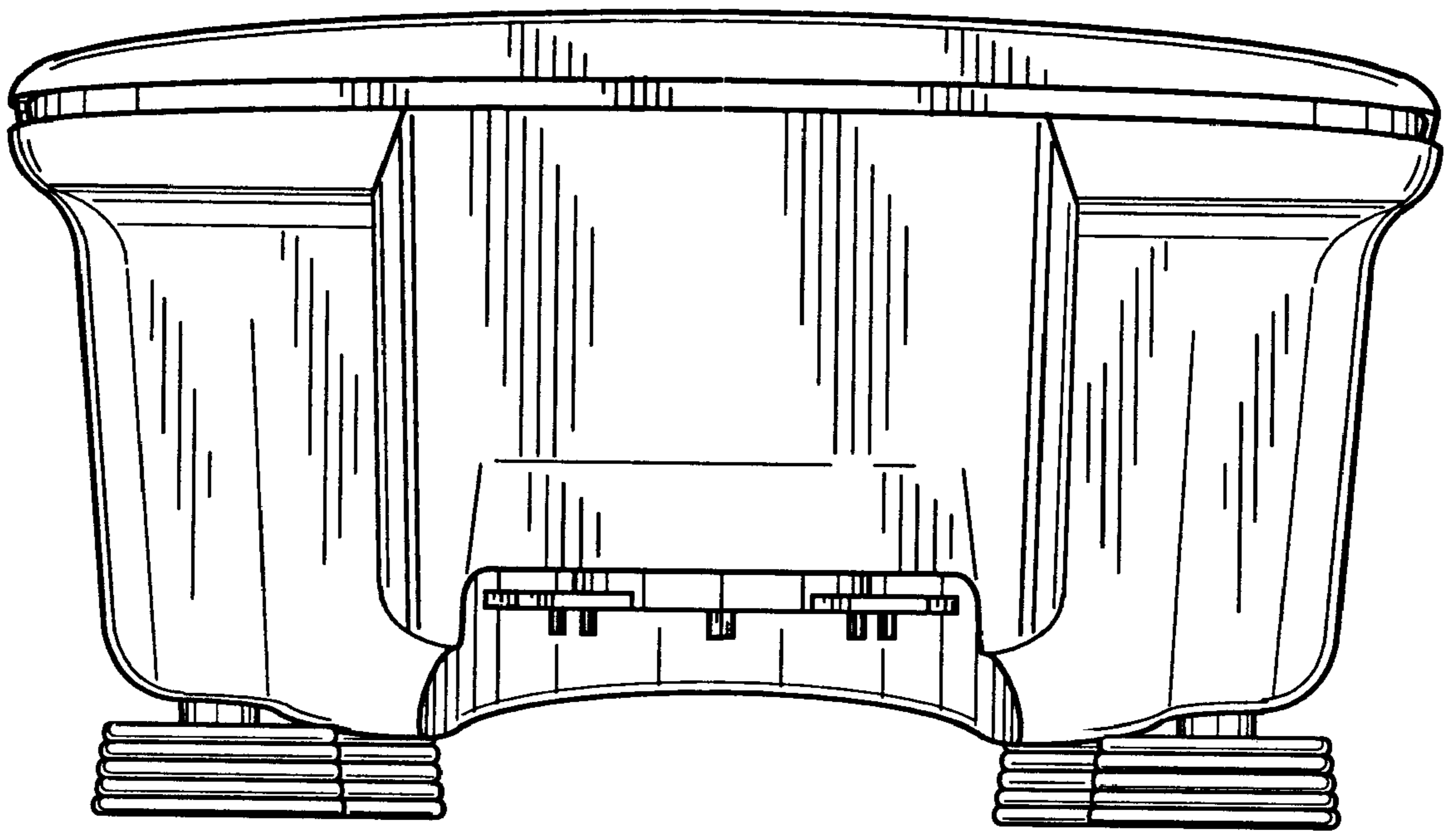

FIG. 5

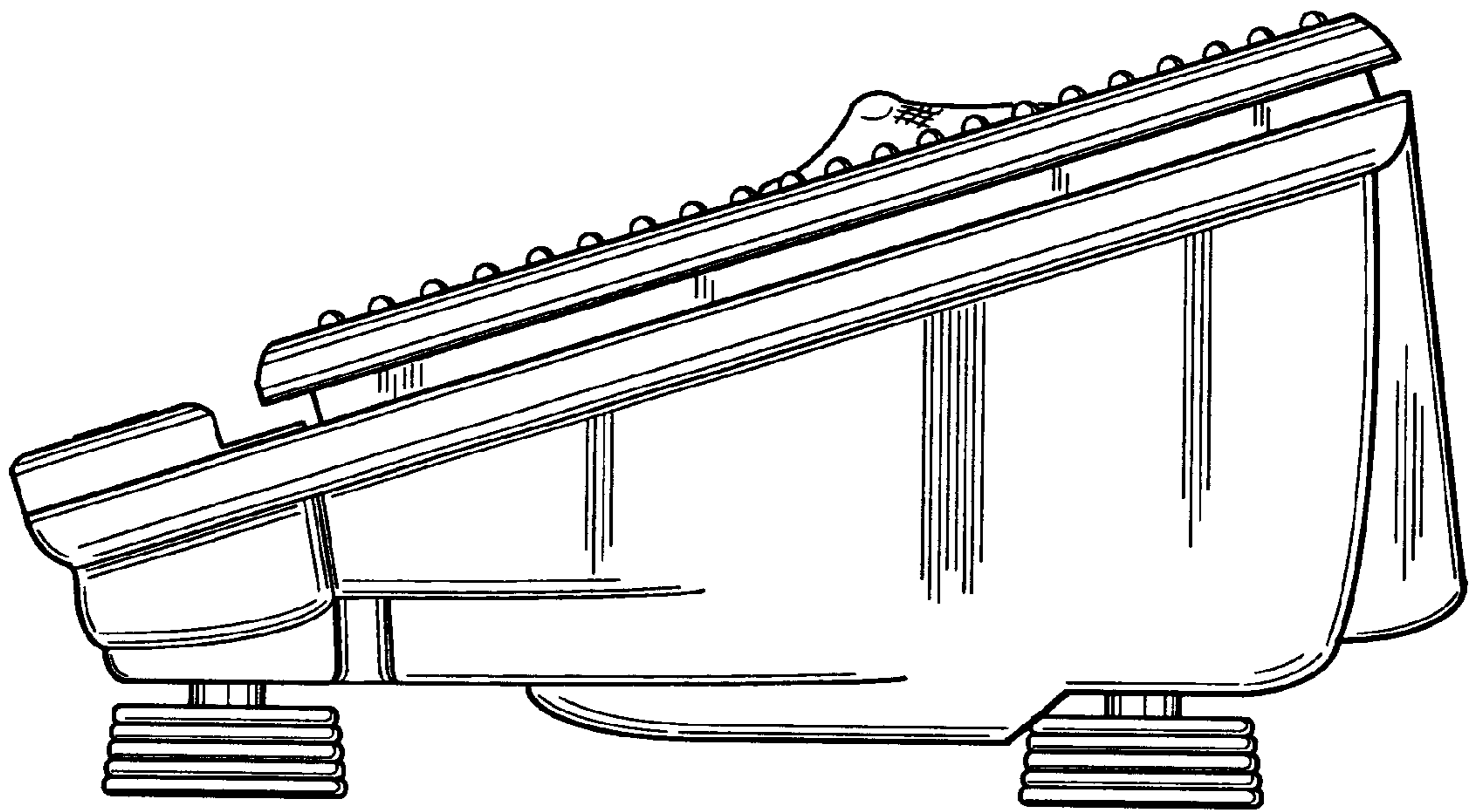

FIG. 6