



US00D420445S

United States Patent [19]

Von Weissenfluh et al.

[11] Patent Number: **Des. 420,445**

[45] Date of Patent: **** Feb. 8, 2000**

[54] **COMBINED ABRASIVE DISK AND SPINDLE FOR DENTAL USE**

[75] Inventors: **Beat A. Von Weissenfluh**, Gentilino; **Gianni Baffelli**, Tesserete, both of Switzerland

[73] Assignee: **Hawe Neos Dental**, Bioggio, Switzerland

[**] Term: **14 Years**

[21] Appl. No.: **29/044,927**

[22] Filed: **Oct. 2, 1995**

Related U.S. Application Data

[63] Continuation-in-part of application No. 29/022,231, Mar. 17, 1994, abandoned.

[30] Foreign Application Priority Data

Oct. 1, 1993 [CH] Switzerland 120816

[51] **LOC (7) Cl.** **24-02**

[52] **U.S. Cl.** **D24/176**

[58] **Field of Search** D24/176-82, 133, D24/146, 152; 433/166, 134

[56] References Cited

U.S. PATENT DOCUMENTS

478,881 7/1892 Moore 433/134

503,258	3/1893	Stanbrough	433/134
505,490	9/1893	Stanbrough	433/134
534,540	2/1895	Wooster	433/134
552,514	1/1896	Chivers	433/134
881,691	3/1908	Hughes	433/134
1,314,125	8/1919	Burlew	433/134
2,685,738	8/1954	Leff	433/134 X
4,055,897	11/1977	Brix	433/166
4,889,489	12/1989	Von Weissenfluh	433/134
4,988,294	1/1991	DuBe et al.	433/134

Primary Examiner—M. H. Tung
Attorney, Agent, or Firm—Foley & Lardner

[57] CLAIM

The ornamental design for a combined abrasive disk and spindle for dental use, as shown and described.

DESCRIPTION

FIG. 1 is a front perspective view of a combined abrasive disk and spindle for dental use showing our new design; FIG. 2 is a rear perspective view thereof; FIG. 3 is a rear elevational view thereof; FIG. 4 is a front elevational view thereof; FIG. 5 is a side elevational view thereof, the opposite side is a mirror image; FIG. 6 is a bottom plan view thereof; and, FIG. 7 is a top plan view thereof.

1 Claim, 4 Drawing Sheets

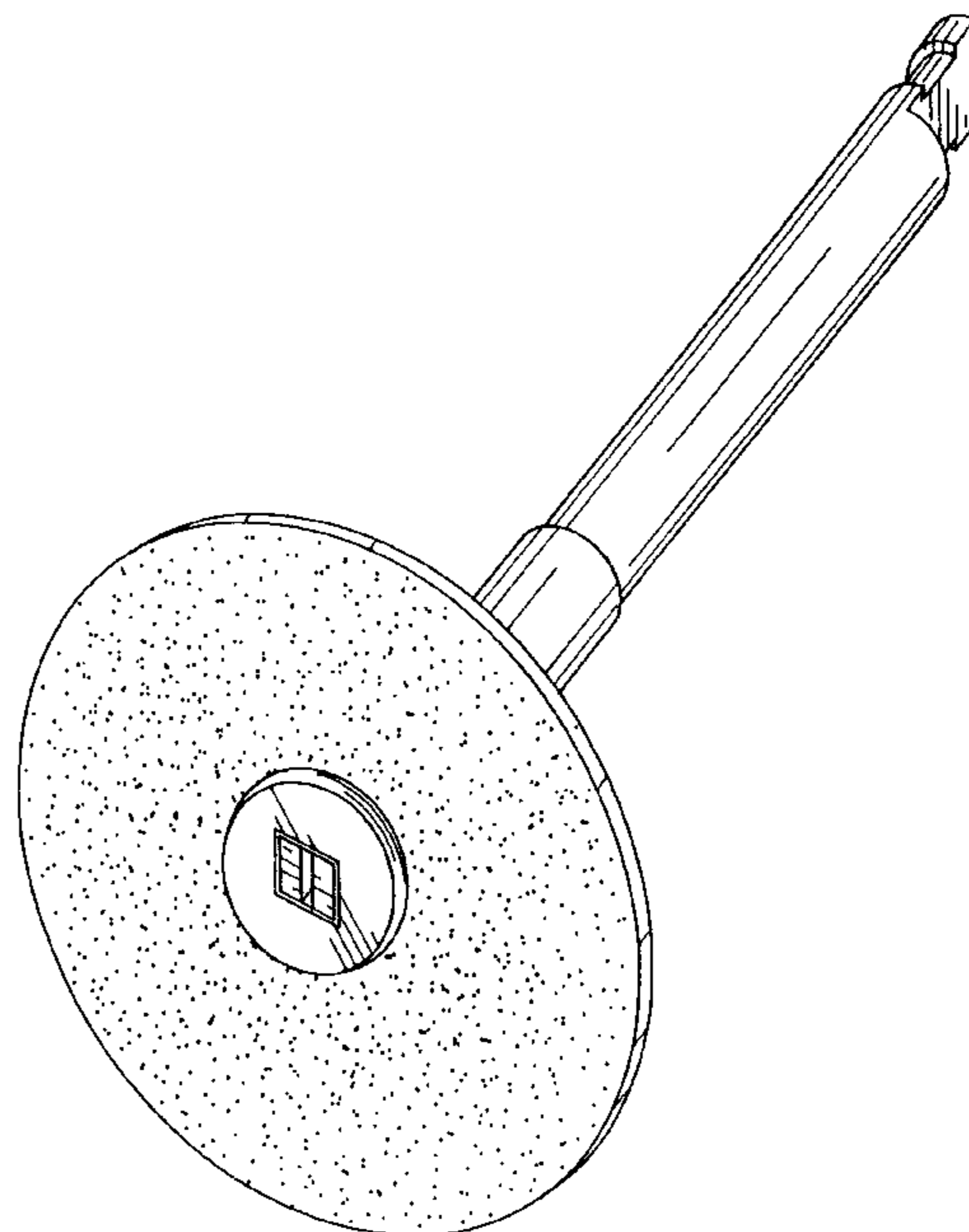
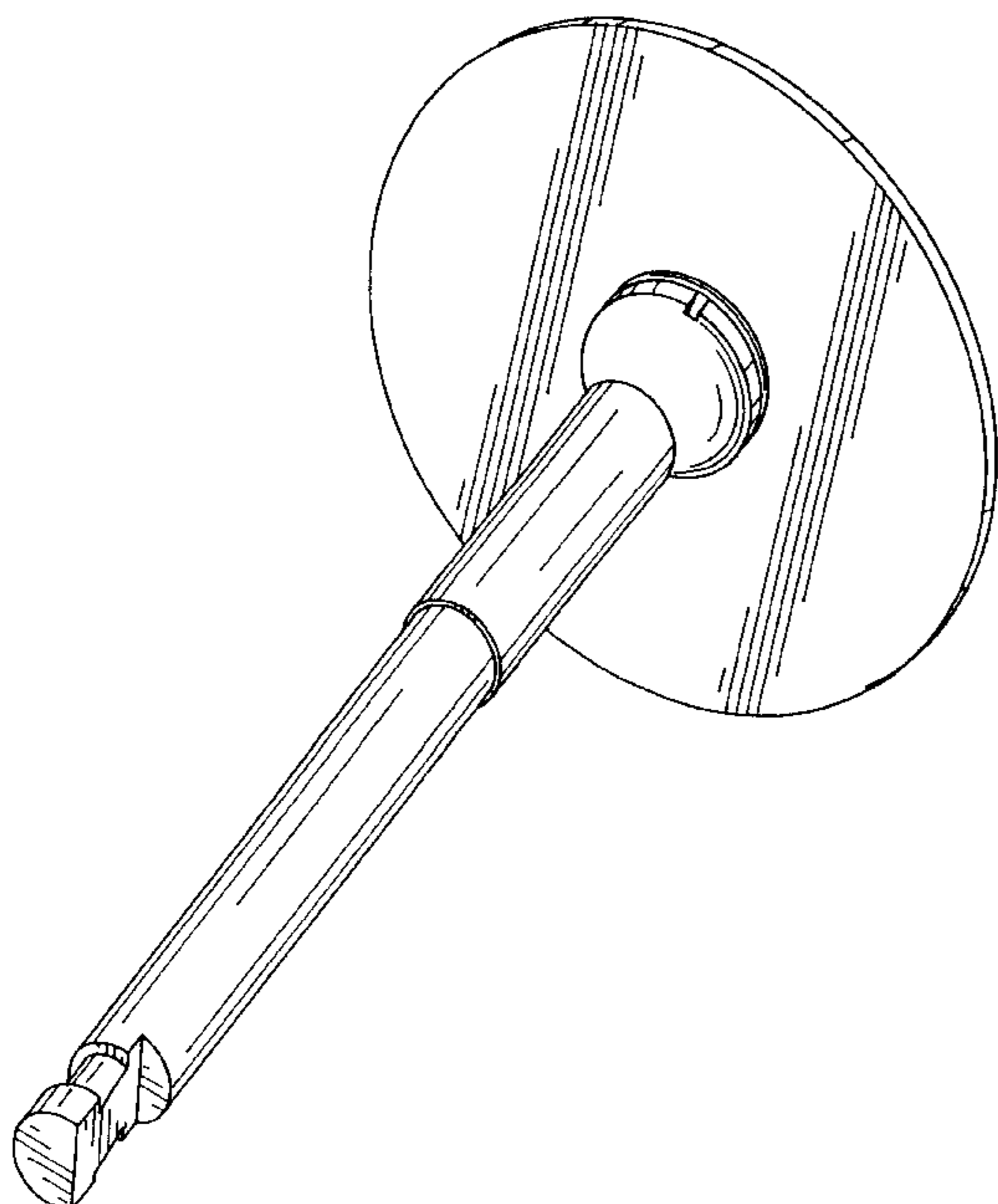

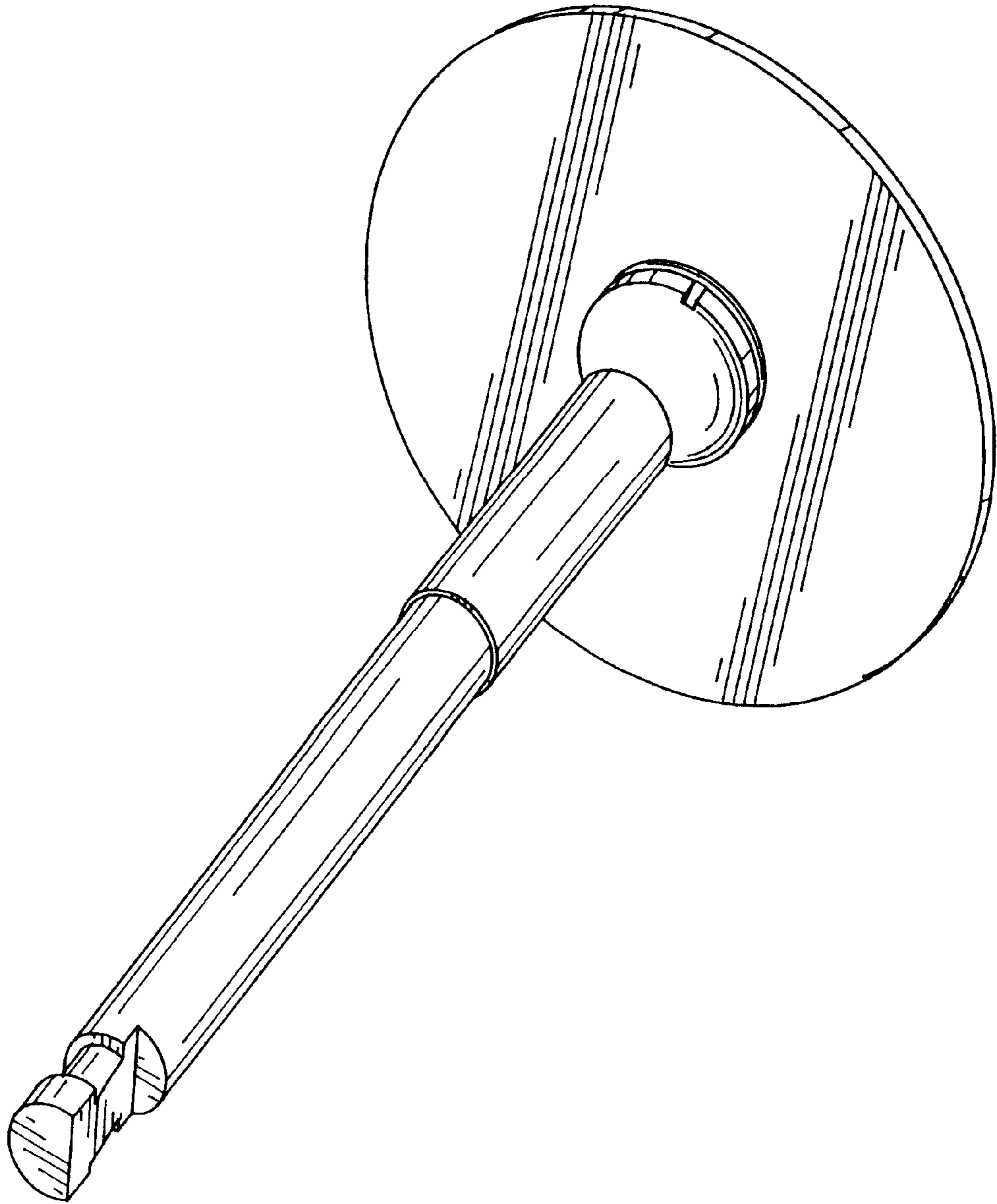

FIG. 1

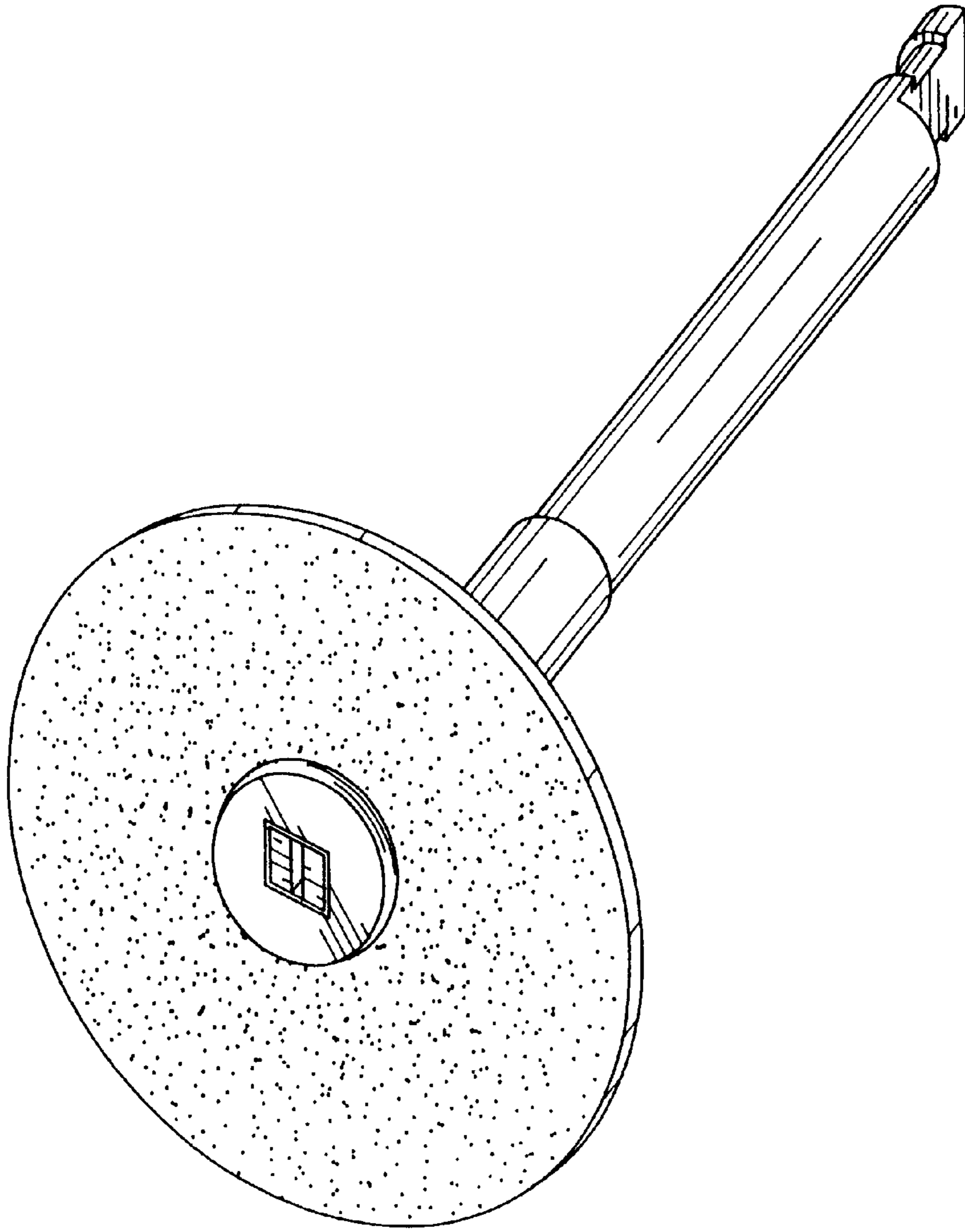

FIG. 2

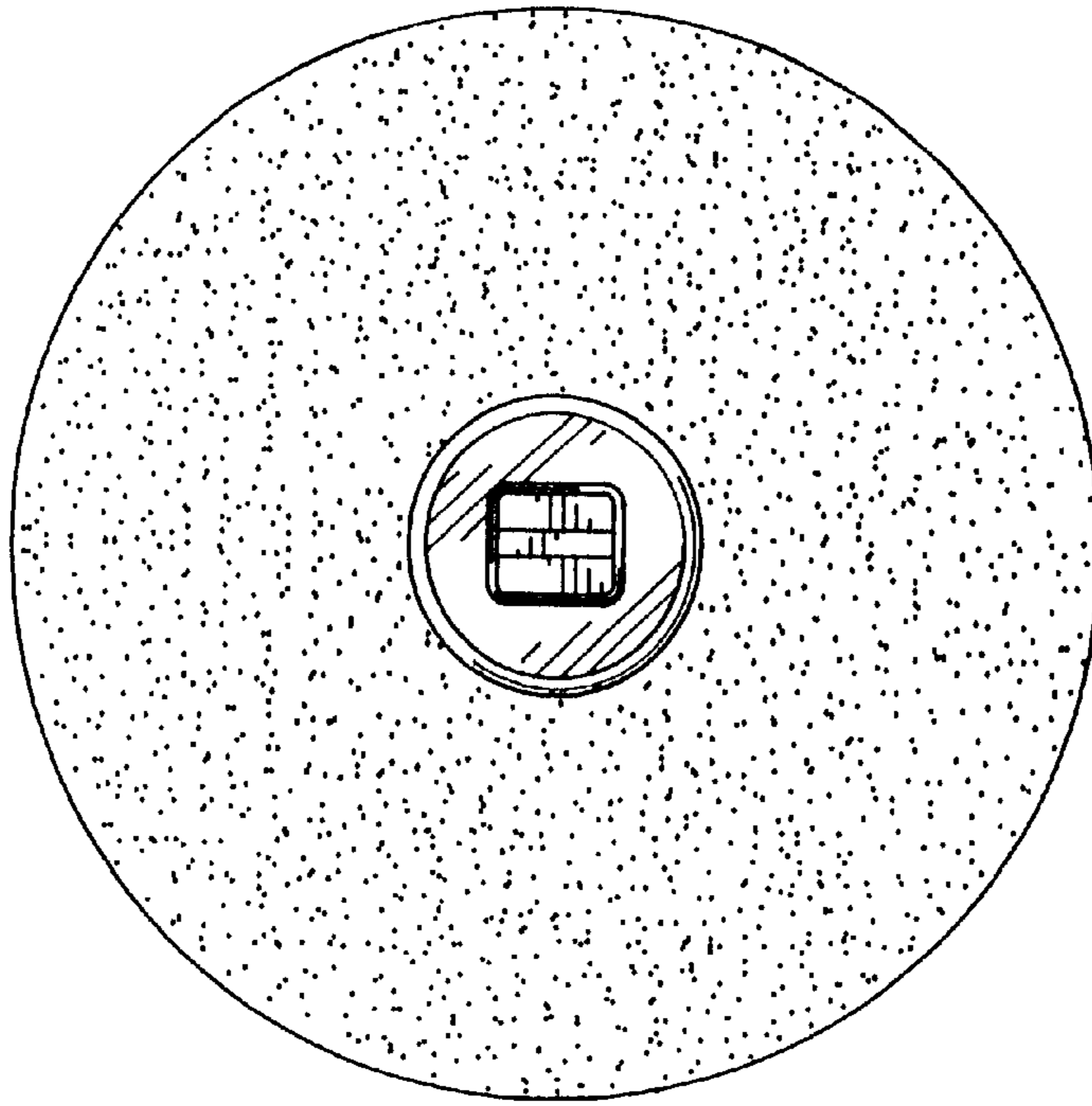

FIG. 3

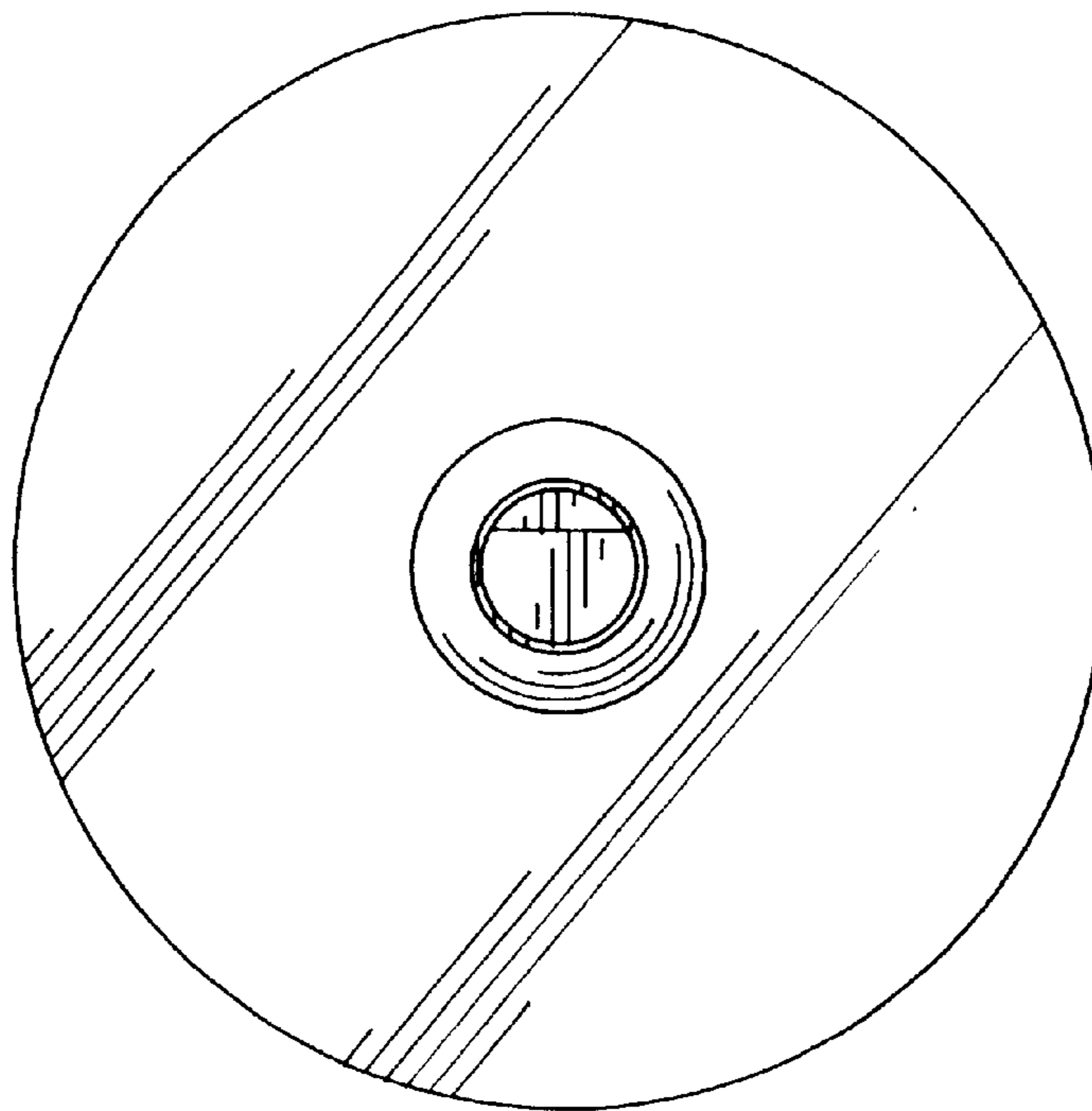

FIG. 4

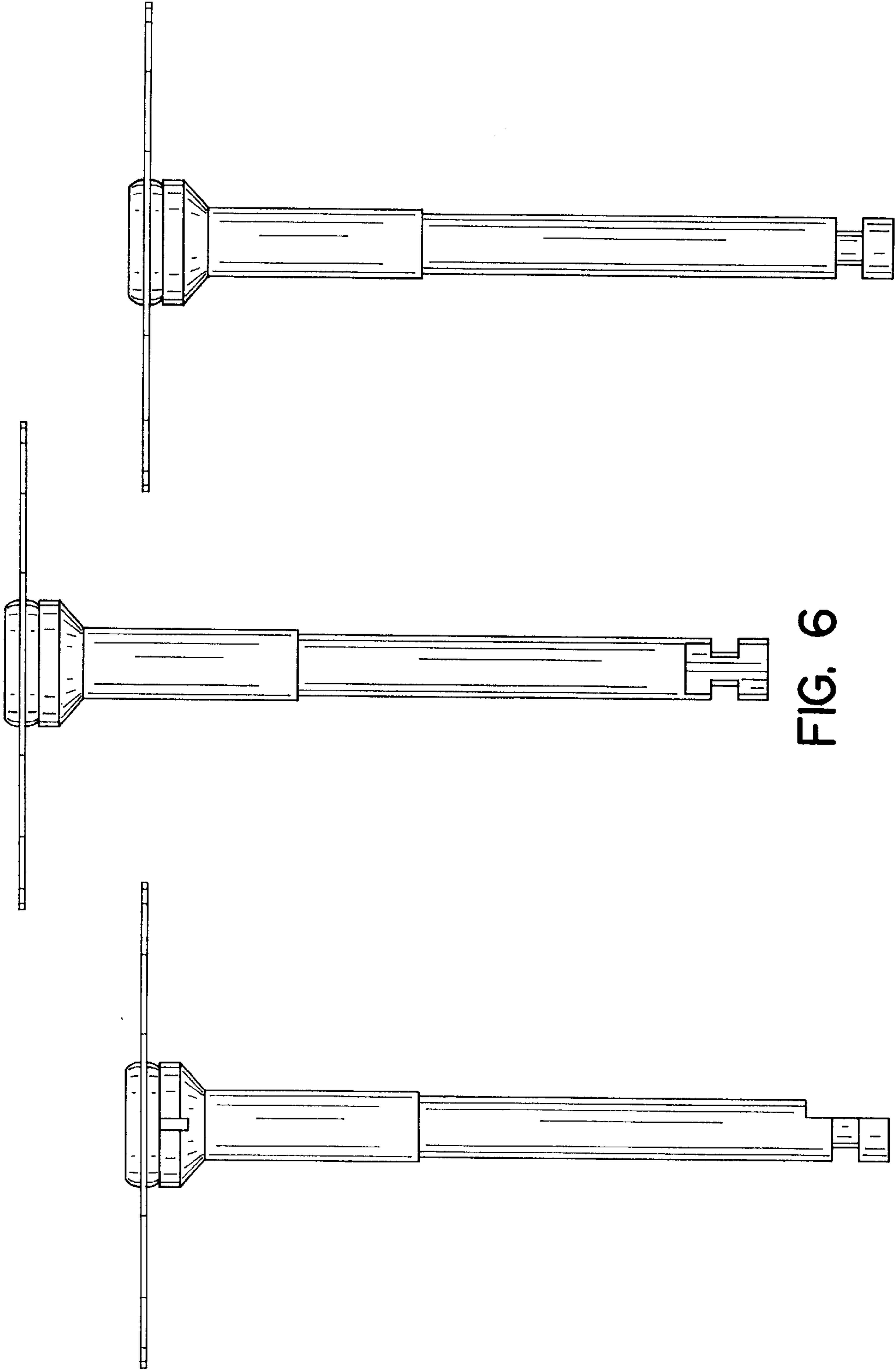

FIG. 7

FIG. 6

FIG. 5