



US00D420402S

United States Patent [19]

[11] Patent Number: Des. 420,402

Alarcon

[45] Date of Patent: ** Feb. 8, 2000

[54] GAME PIECES WITH GAME BOARD

[76] Inventor: **Jose Antonio Mora Alarcon, c/**
Belgica, 6 PTA 15, Valencia, Spain,
46021

[**] Term: **14 Years**

[21] Appl. No.: **29/091,841**

[22] Filed: **Aug. 6, 1998**

[51] LOC (7) Cl. **21-01**

[52] U.S. Cl. **D21/386; D21/349**

[58] Field of Search D21/334-368,
D21/390, 376, 386; 273/236-288

[56] References Cited

U.S. PATENT DOCUMENTS

D. 33,151	9/1900	Boggis	273/236
D. 55,482	6/1920	McIntyre et al.	D21/349
D. 175,418	8/1955	Kaye et al.	D21/386
D. 369,628	5/1996	Riddle	D21/349
3,888,490	6/1975	Kline	273/243
5,497,998	3/1996	Horton	273/285

Primary Examiner—Sandra L. Morris
Attorney, Agent, or Firm—Darby & Darby

[57] CLAIM

The ornamental design for game pieces with game board, as shown and described.

DESCRIPTION

FIG. 1 is a top perspective view of the game board with representative game pieces thereon;
 FIG. 2 is an enlarged top plan view thereof;
 FIG. 3 is front elevational view thereof, the rear view and both side views being identical;
 FIG. 4 is a bottom plan view thereof;
 FIG. 5 is a further enlarged top right perspective view of the first game piece for use with the game board;
 FIG. 6 is front elevational view of the first game piece, all side views and the rear view being identical;
 FIG. 7 is a top plan view of the first game piece;

FIG. 8 is a top right perspective view of a second game piece for use with the game board;
 FIG. 9 is a front elevational view of the second game piece, the rear elevational view being a mirror image thereof;
 FIG. 10 is a right side elevational view of the second game piece for use with the game board, the left side elevational view being a mirror image thereof;
 FIG. 11 is a top plan view of the second game piece;
 FIG. 12 is a top right perspective view of a third game piece for use with the game board;
 FIG. 13 is a front elevational view of the third game piece, the rear elevational view being a mirror image thereof;
 FIG. 14 is a right side elevational view of the third game piece for use with the game board, the left side elevational view being a mirror image thereof;
 FIG. 15 is a top plan view of the third game piece;
 FIG. 16 is a top right perspective view of a fourth game piece for use with the game board;
 FIG. 17 is a front elevational view of the fourth game piece, the rear elevational view being a mirror image thereof;
 FIG. 18 is a right side elevational view of the fourth game piece for use with the game board, the left side elevational view being a mirror image thereof;
 FIG. 19 is a top plan view of the fourth game piece;
 FIG. 20 is a top right perspective view of a fifth game piece for use with the game board;
 FIG. 21 is a front elevational view of the fifth game piece, the rear elevational view being a mirror image thereof;
 FIG. 22 is a right side elevational view of the fifth game piece for use with the game board, the left side elevational view being a mirror image thereof;
 FIG. 23 is a top plan view of the game piece;
 FIG. 24 is a top perspective view of a sixth game piece for use with the game board;
 FIG. 25 is a front elevational view of the sixth game piece, the rear elevational view being a mirror image thereof;
 FIG. 26 is a right side elevational view of the sixth game piece for use with the game board, the left side elevational view being a mirror image thereof;
 FIG. 27 is a top plan view of the sixth game piece;
 FIG. 28 is a top right perspective view of a seventh game piece for use with the game board;
 FIG. 29 is a front elevational view of the seventh game piece, the rear elevational view being a mirror image thereof;

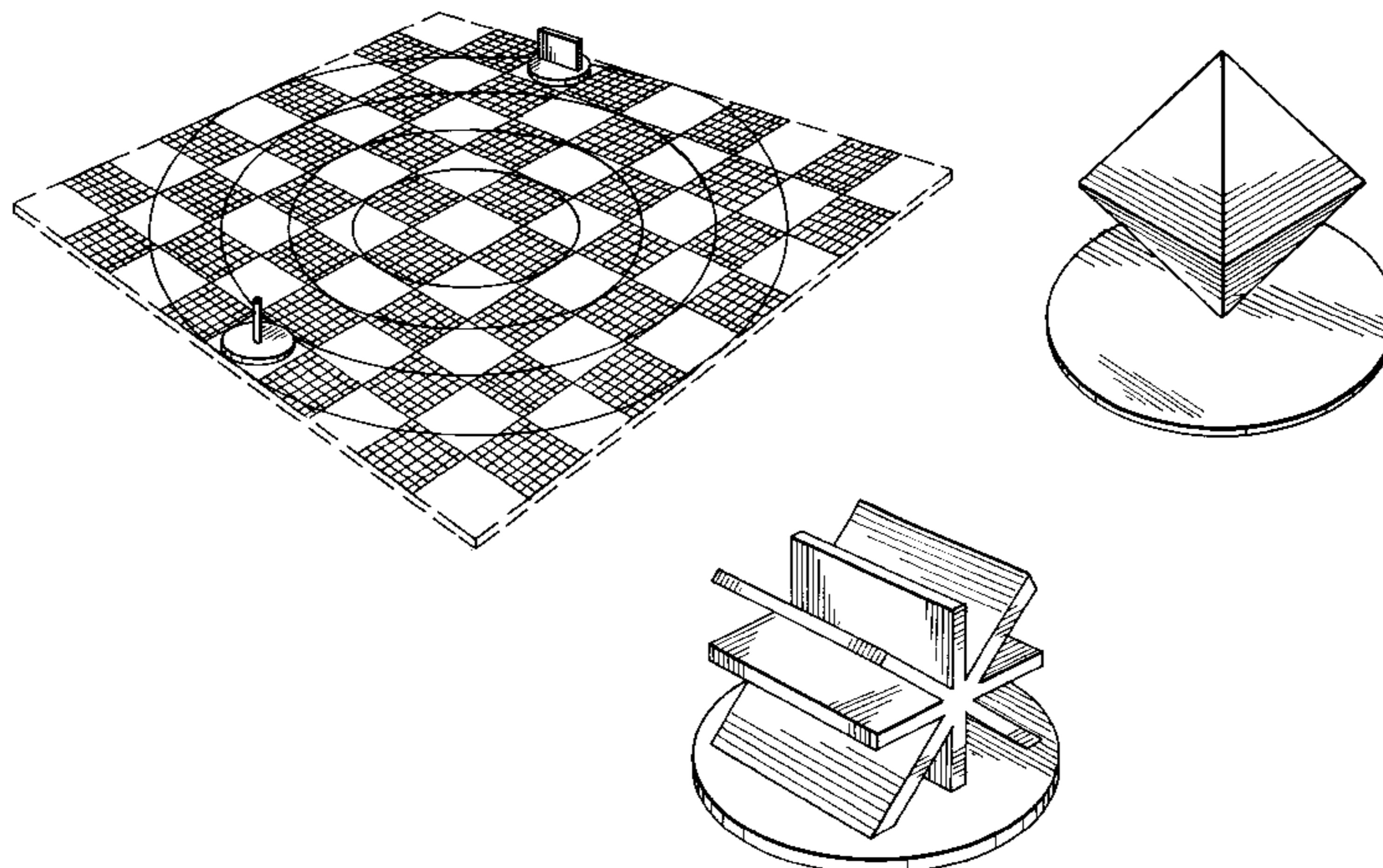

FIG. 30 is a right side elevational view of the seventh game piece for use with the game board, the left side elevational view being a mirror image thereof;

FIG. 31 is a top plan view of the seventh game piece;

FIG. 32 is a top right perspective view of an eighth game piece for use with the game board;

FIG. 33 is a front elevational view of the eighth game piece, the rear elevational view being a mirror image thereof;

FIG. 34 is a right side elevational view of the eighth game piece for use with the game board, the left side elevational view being a mirror image thereof;

FIG. 35 is a top plan view of the eighth game piece;

FIG. 36 is a top right perspective view of a ninth game piece for use with the game board;

FIG. 37 is a front elevational view of the ninth game piece, the rear elevational view being a mirror image thereof;

FIG. 38 is a right side elevational view of the ninth game piece for use with the game board, the left side elevational view being a mirror image thereof;

FIG. 39 is a top plan view of the ninth game piece;

FIG. 40 is a top right perspective view of a tenth game piece for use with the game board;

FIG. 41 is a front elevational view of the tenth game piece, the rear view and both side views being identical;

FIG. 42 is a top plan view of the tenth game piece;

FIG. 43 is a top right perspective view of an eleventh game piece for use with the game board;

FIG. 44 is a front elevational view of the eleventh game piece, the rear view and both side views being identical;

FIG. 45 is a top plan view of the eleventh game piece;

FIG. 46 is a top right perspective view of a twelfth game piece for use with the game board;

FIG. 47 is a front elevational view of the twelfth game piece, the rear elevational view being a mirror image thereof;

FIG. 48 is a right side elevational view of the twelfth game piece for use with the game board, the left side elevational view being a mirror image thereof;

FIG. 49 is a top plan view of the twelfth game piece;

FIG. 50 is a top right perspective view of a thirteenth game piece for use with the game board;

FIG. 51 is a front elevational view of the thirteenth game piece, the rear elevational view being a mirror image thereof;

FIG. 52 is a right side elevational view of the thirteenth game piece for use with the game board, the left side elevational view being a mirror image thereof;

FIG. 53 is a top plan view of the thirteenth game piece;

FIG. 54 is a top right perspective view of a fourteenth game piece for use with the game board;

FIG. 55 is a front elevational view of the fourteenth game piece, the rear view and both side views being identical;

FIG. 56 is a top plan view of the fourteenth game piece;

FIG. 57 is a top right perspective view of a fifteenth game piece for use with the game board;

FIG. 58 is a front elevational view of the fifteenth game piece, the rear view and both side views being identical;

FIG. 59 is a top plan view of the fifteenth game piece;

FIG. 60 is a top right perspective view of a sixteenth game piece for use with the game board;

FIG. 61 is a front elevational view of the sixteenth game piece, the rear view and both side views being identical;

FIG. 62 is a top plan view of the sixteenth game piece; and,

FIG. 63 is a bottom plan view of the game pieces illustrated in FIGS. 5 through 62.

The broken line showing of the boundary of the game board in FIGS. 1-4 is for illustrative purposes only, and forms no part of the claimed design.

1 Claim, 12 Drawing Sheets

FIG. 1

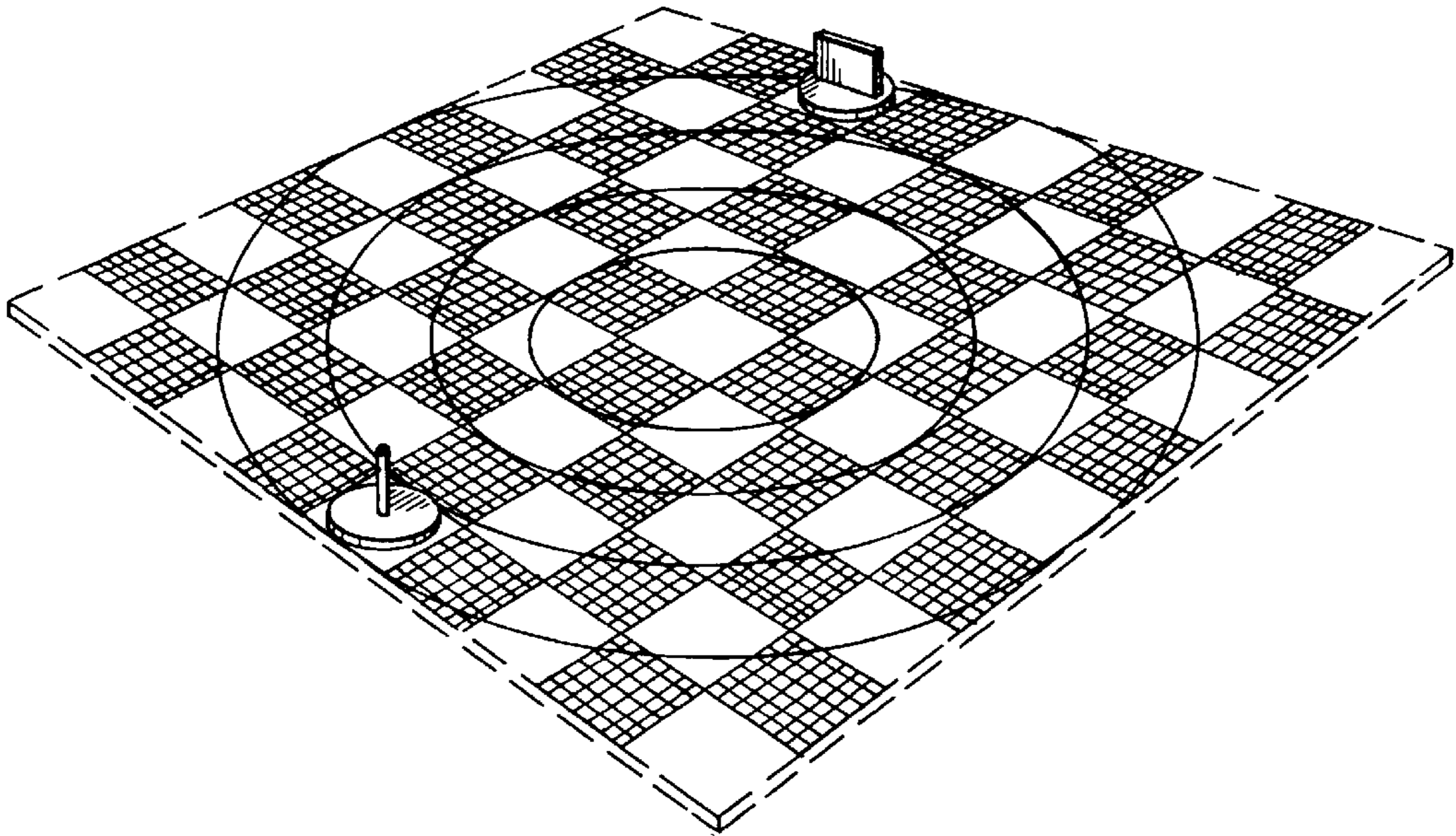

FIG. 2

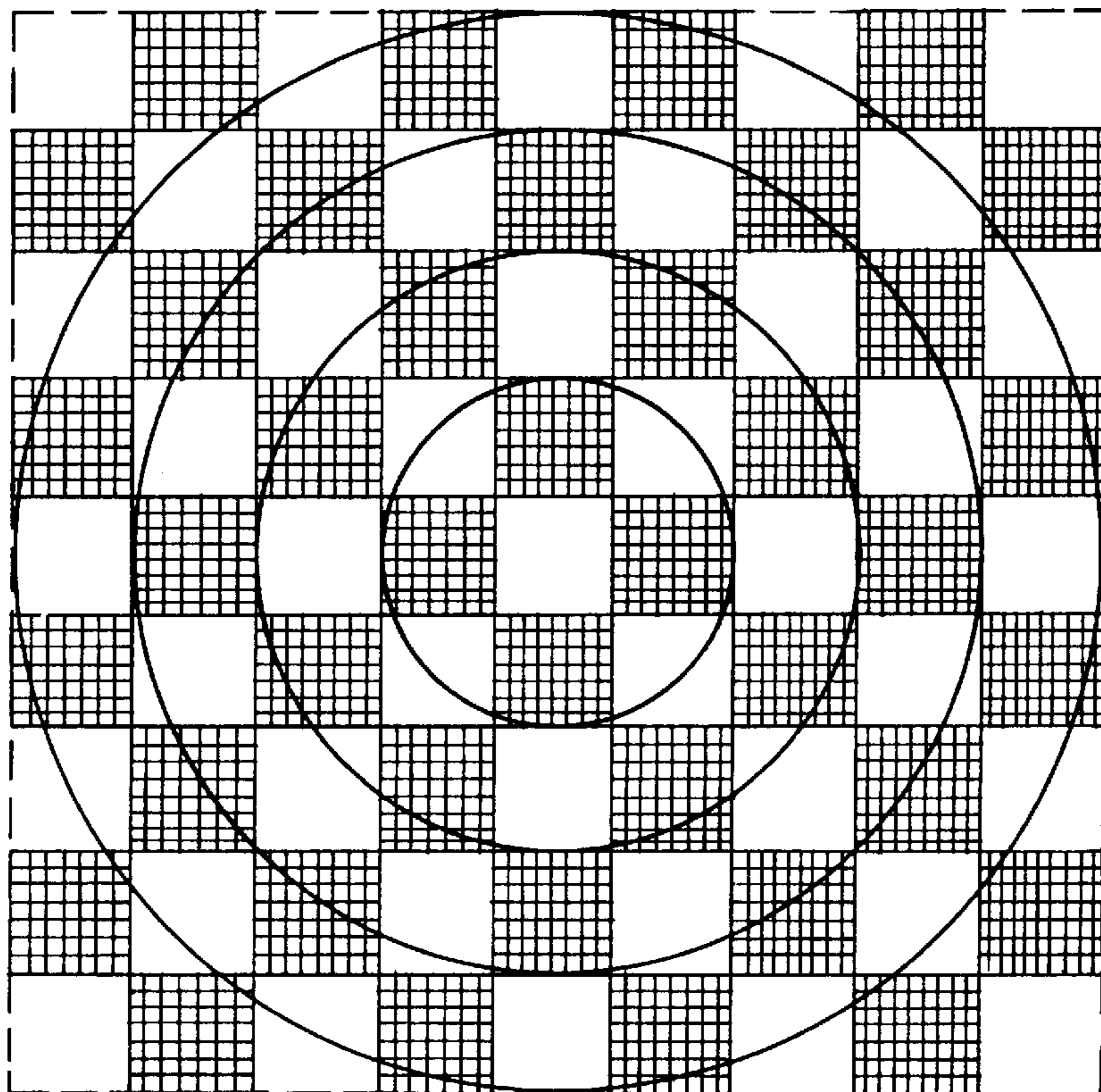

FIG. 3

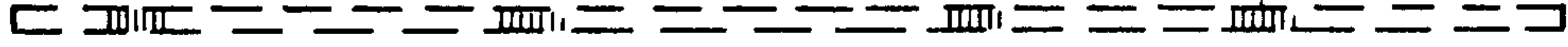

FIG. 4

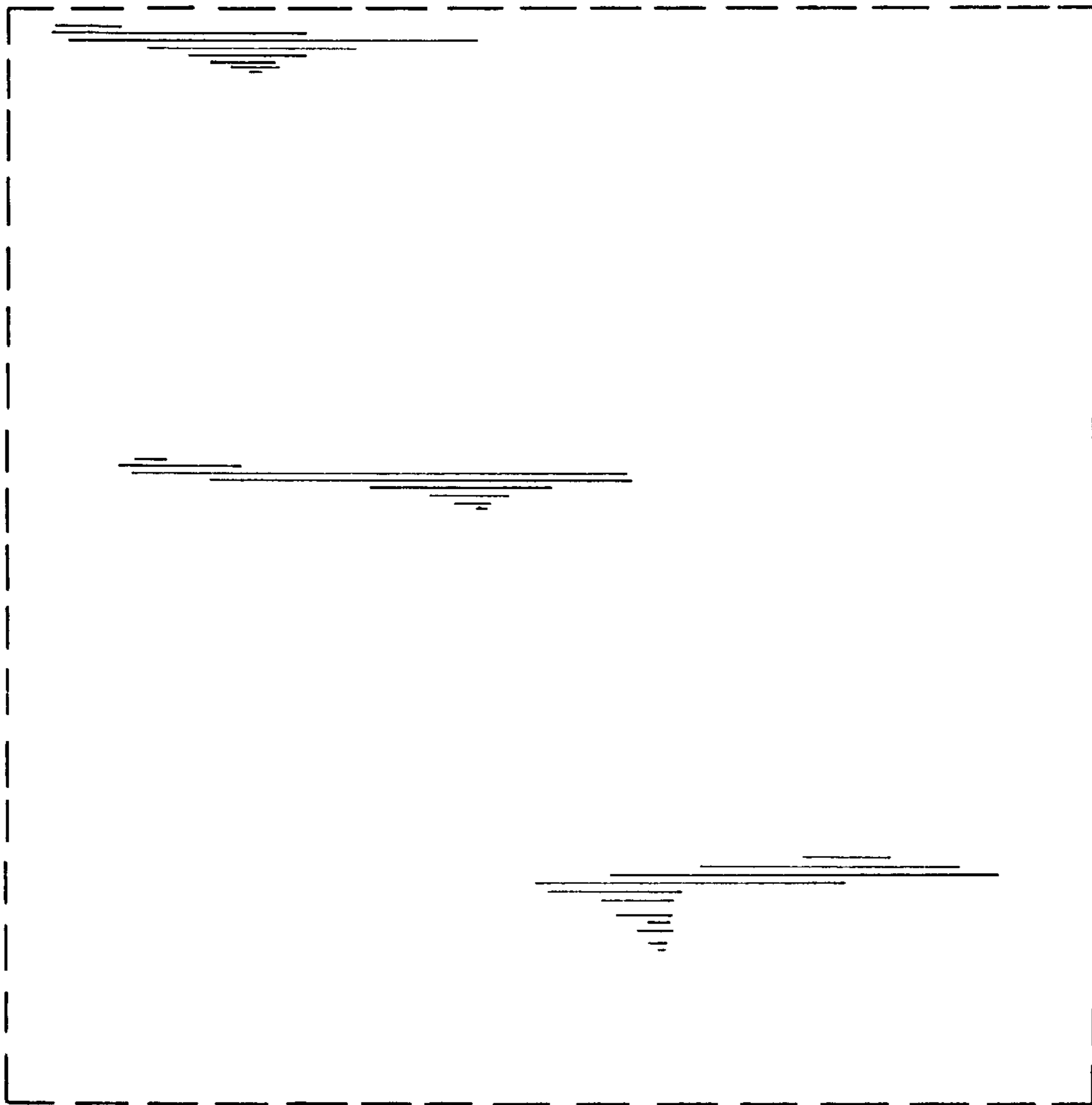

FIG. 5

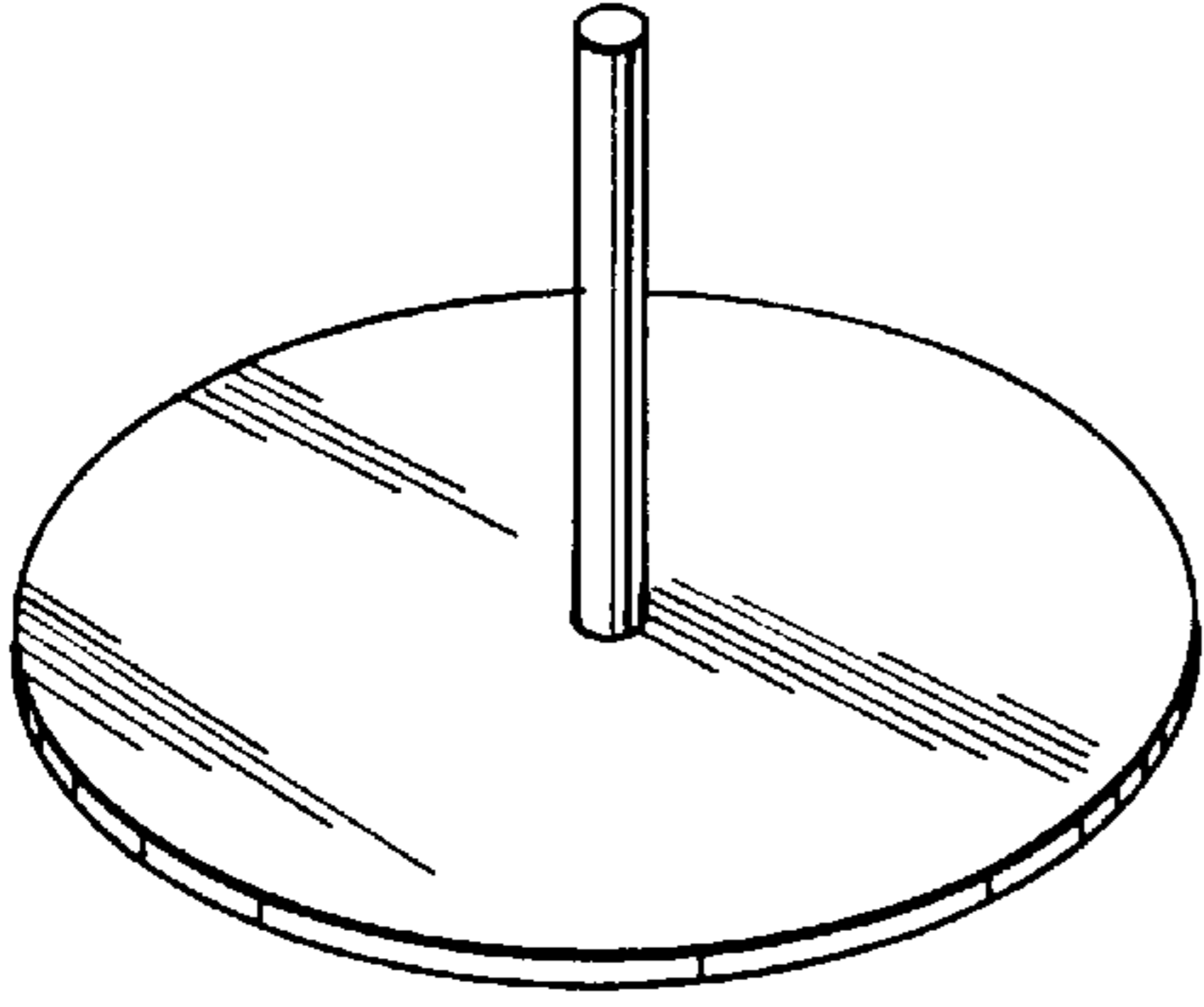

FIG. 6

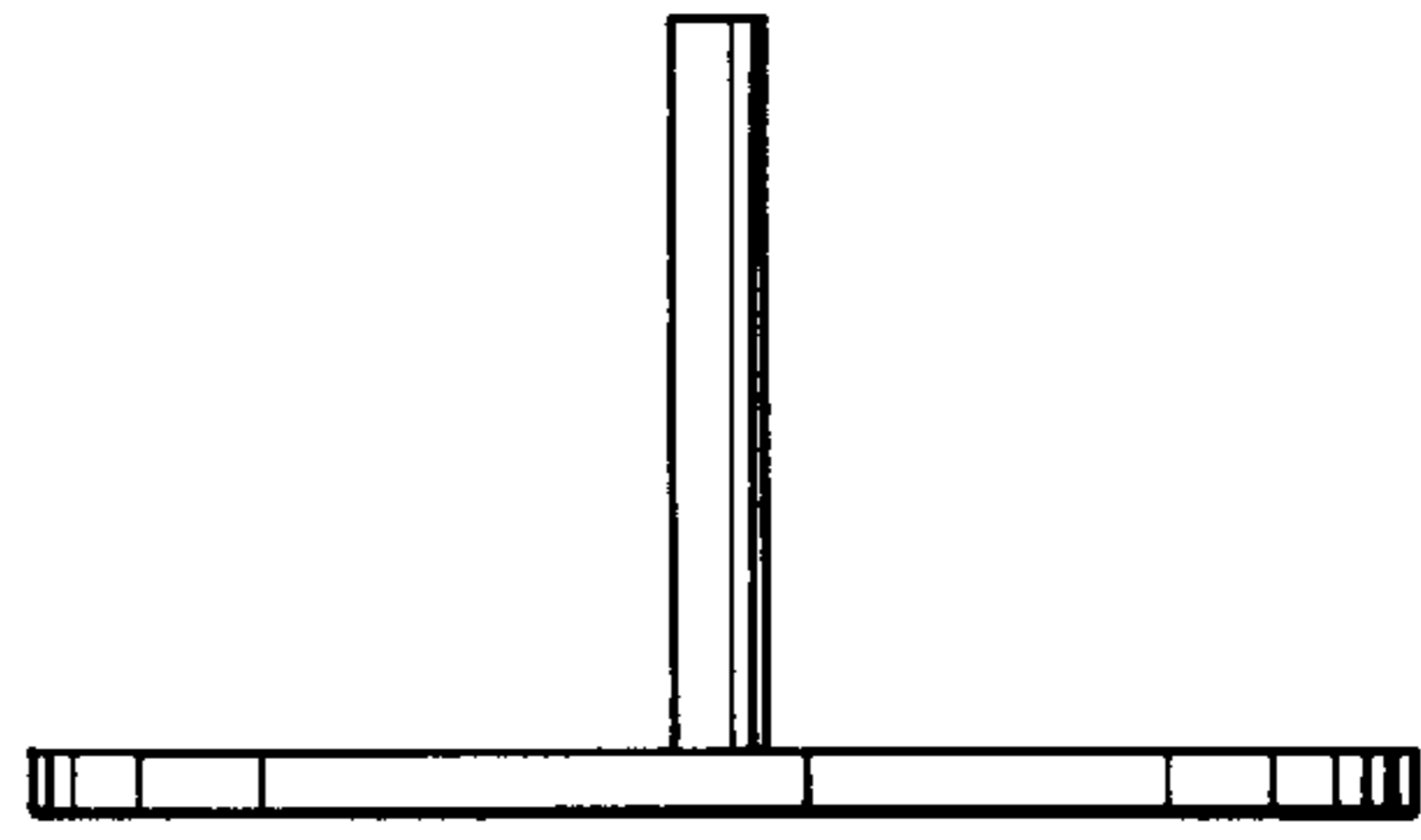

FIG. 7

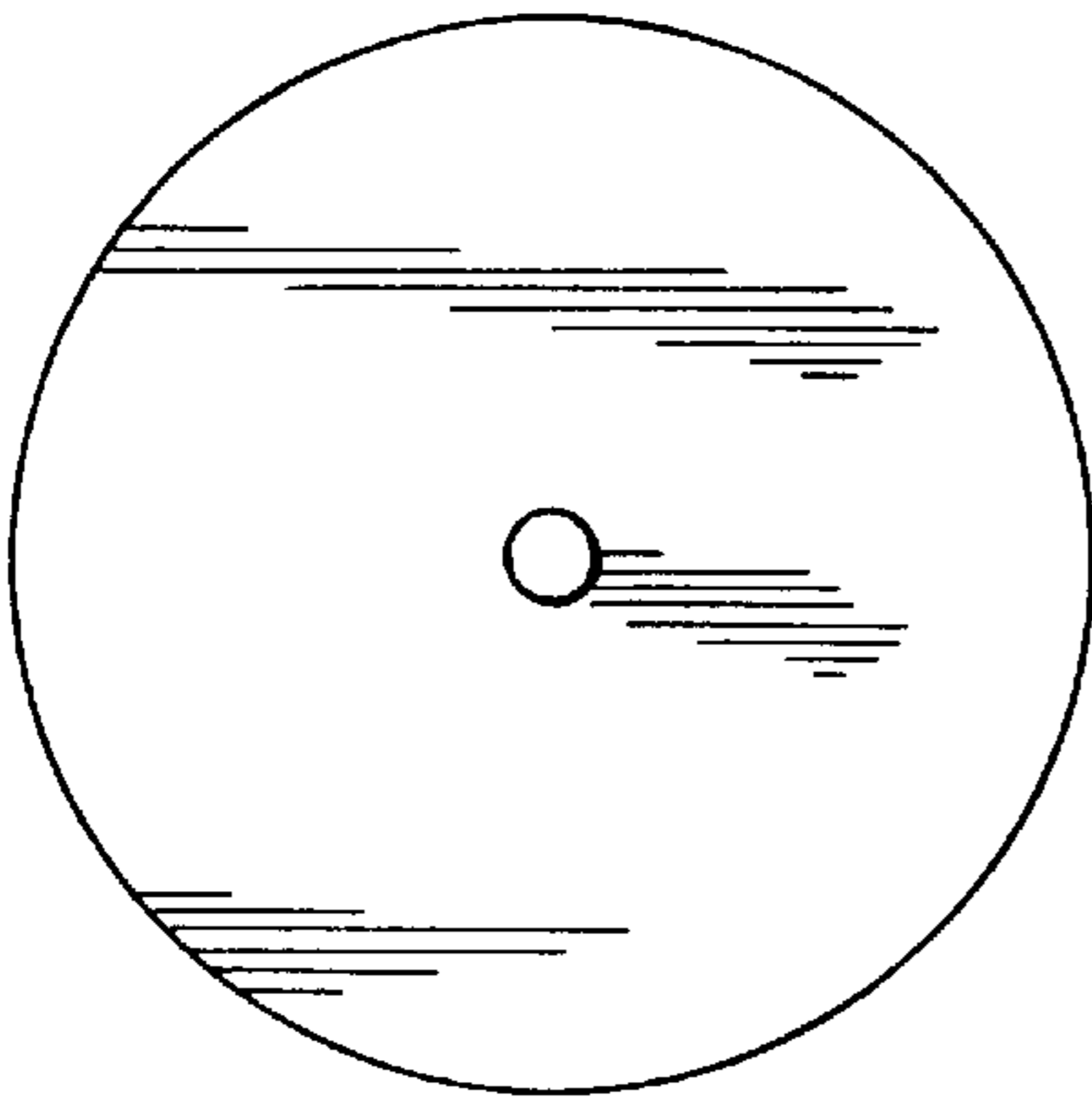

FIG. 8

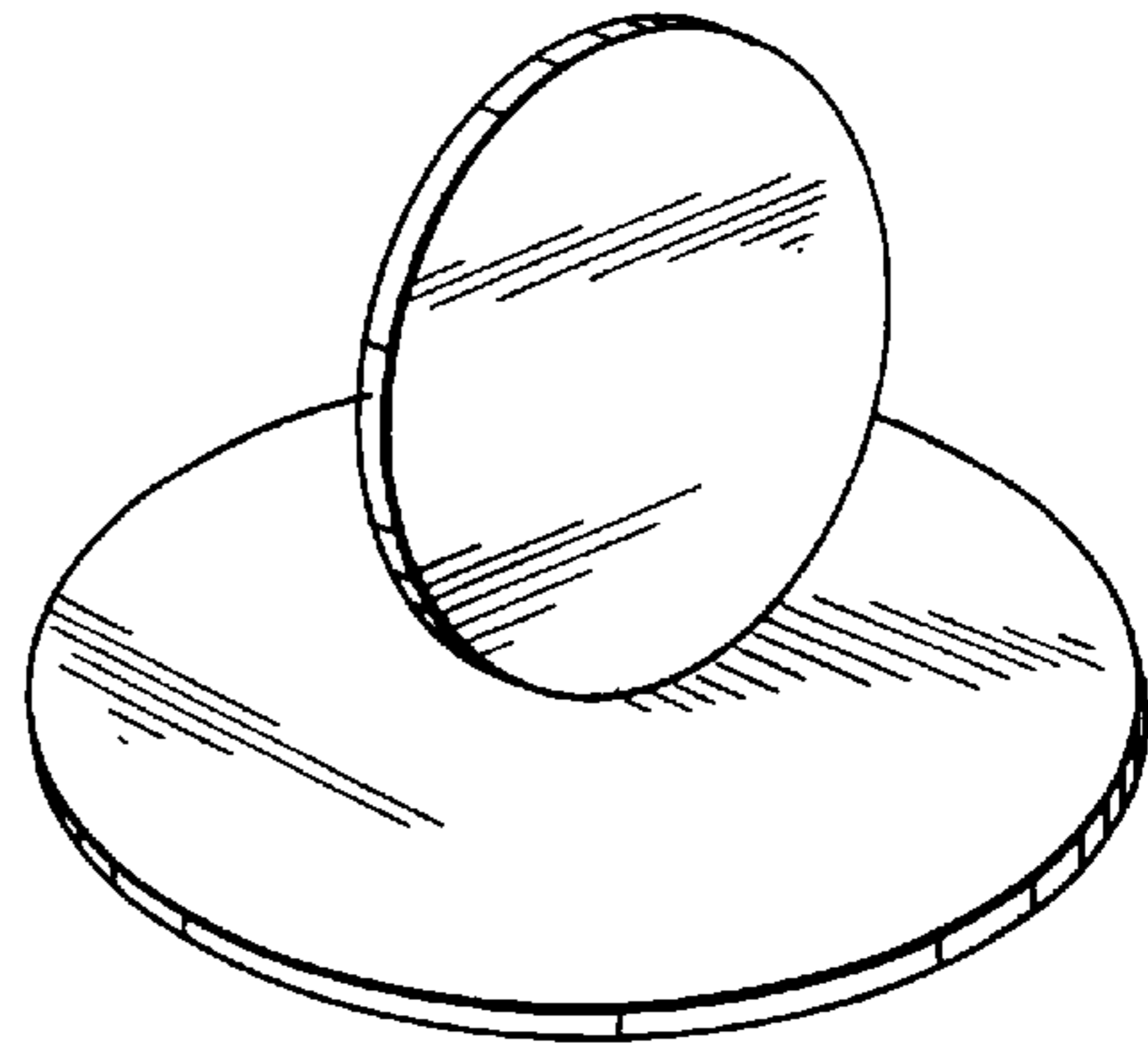

FIG. 9

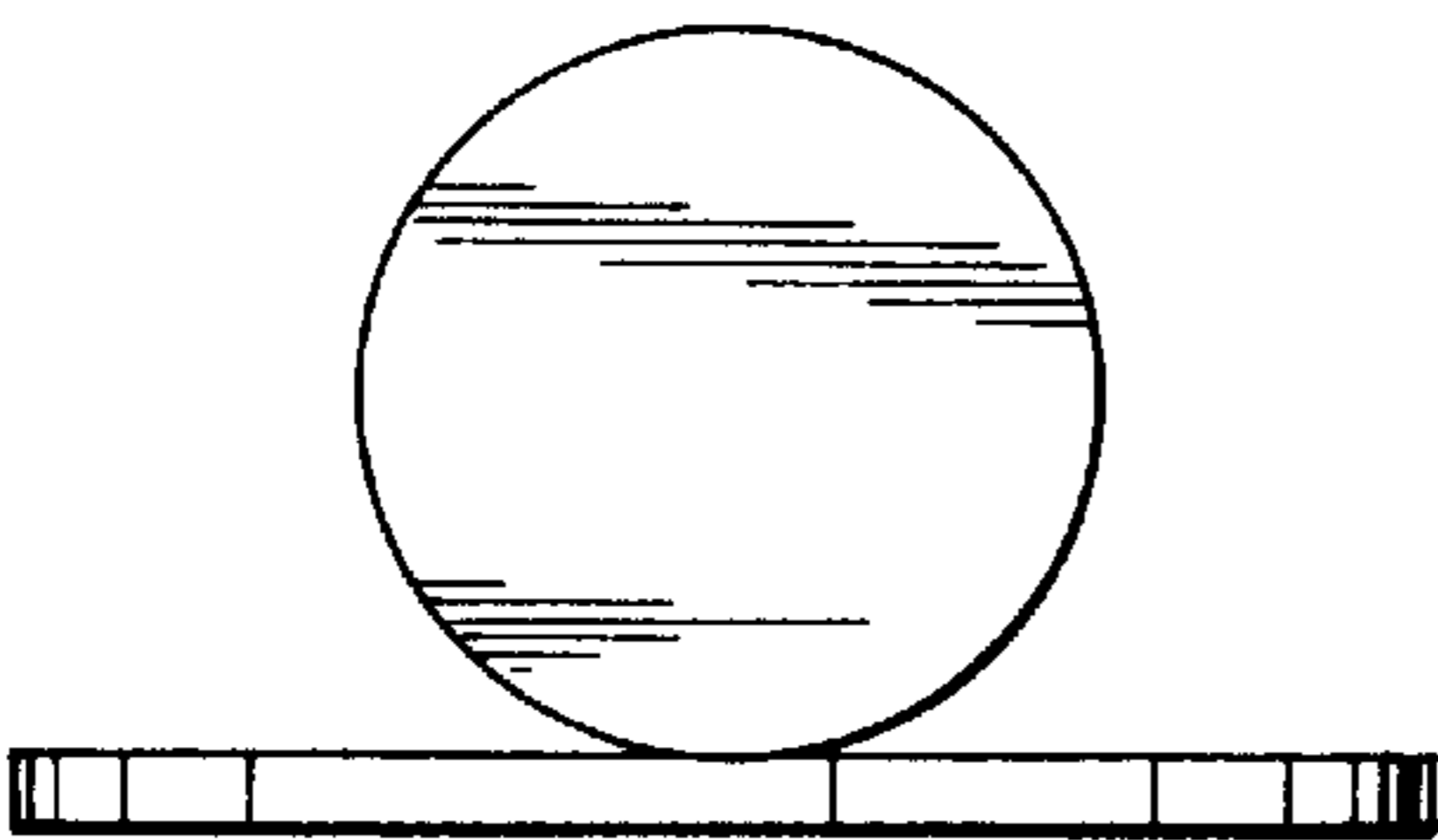

FIG. 10

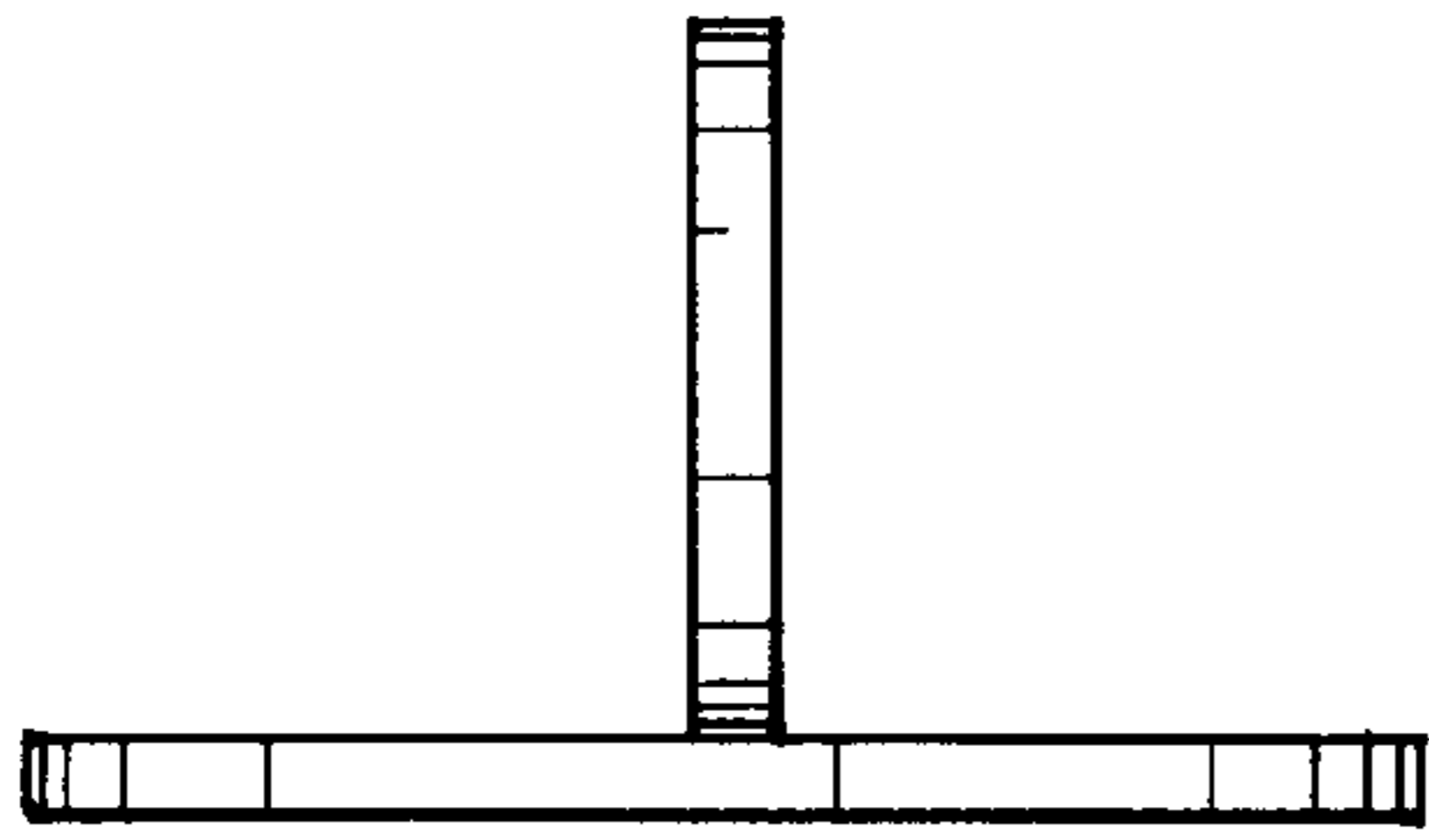

FIG. 11

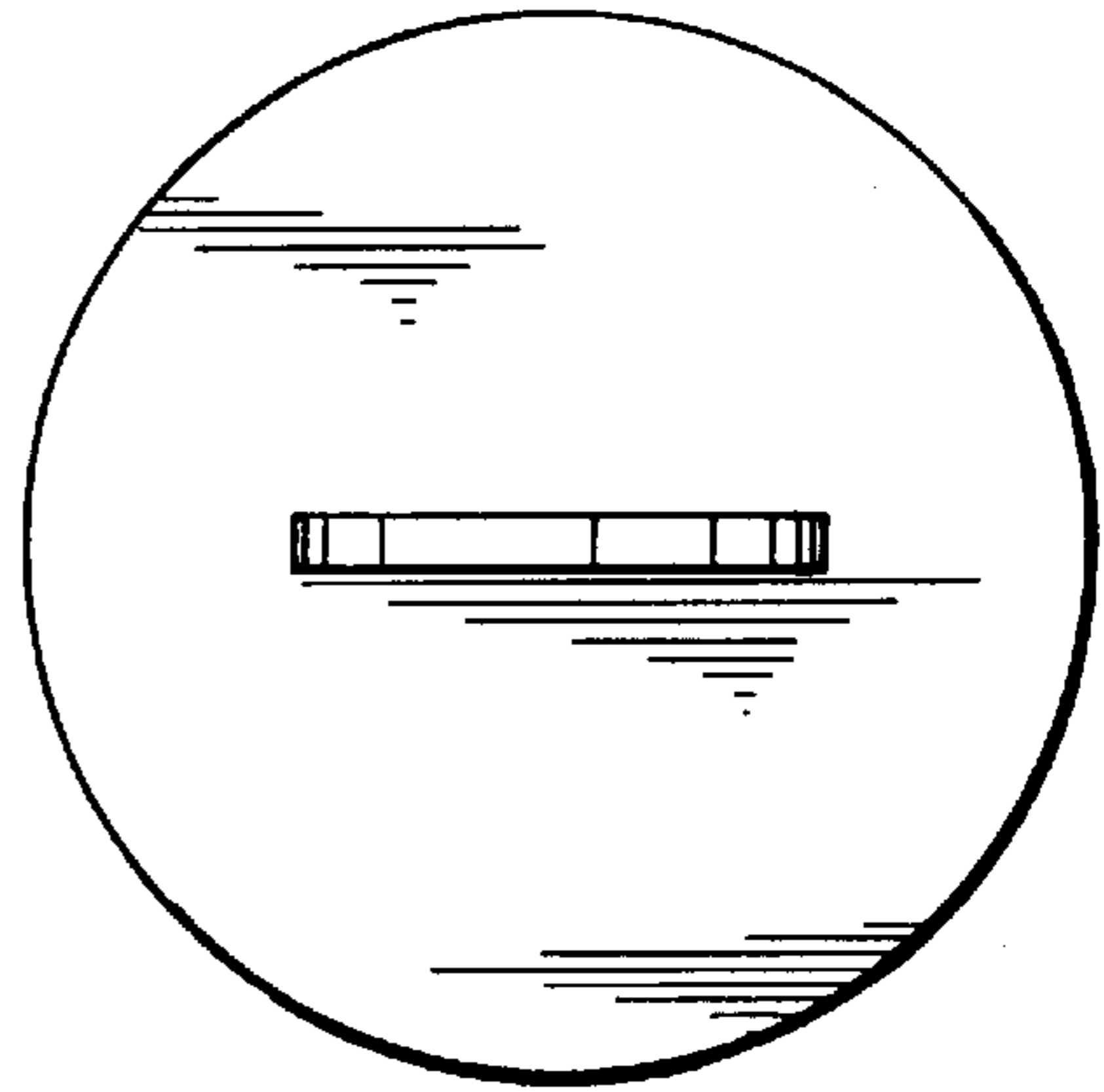

FIG. 12

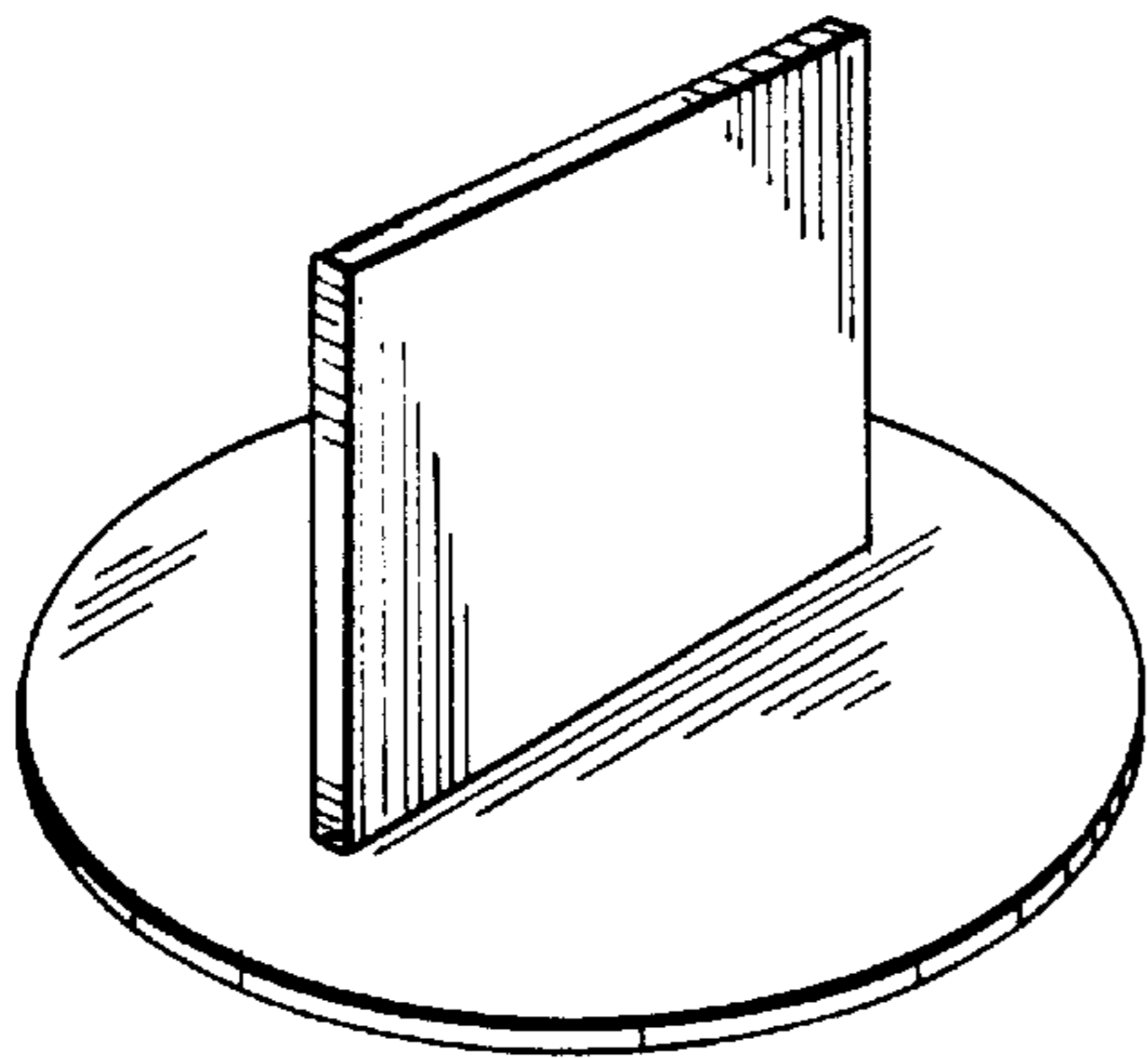

FIG. 13

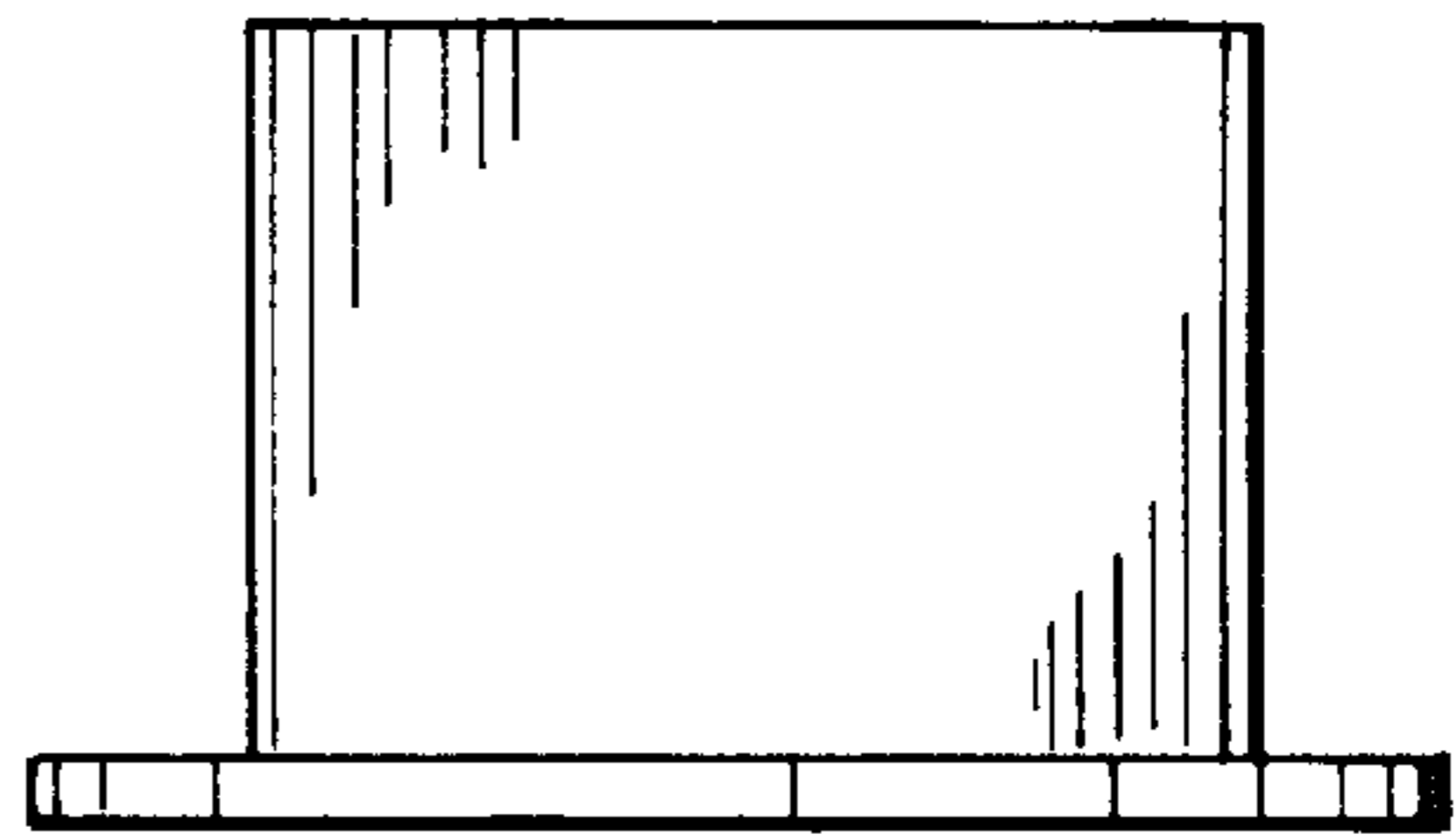

FIG. 14

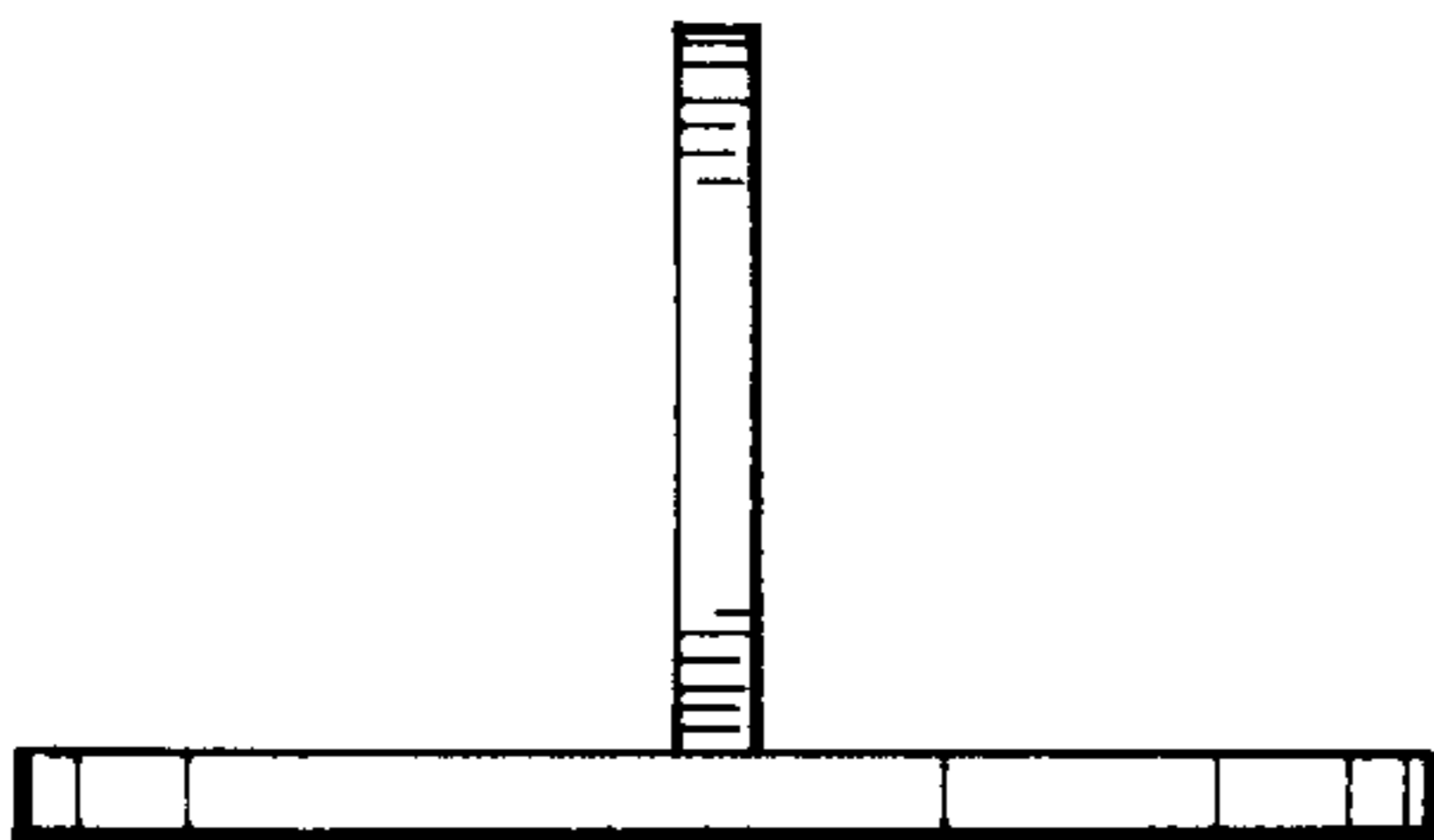

FIG. 15

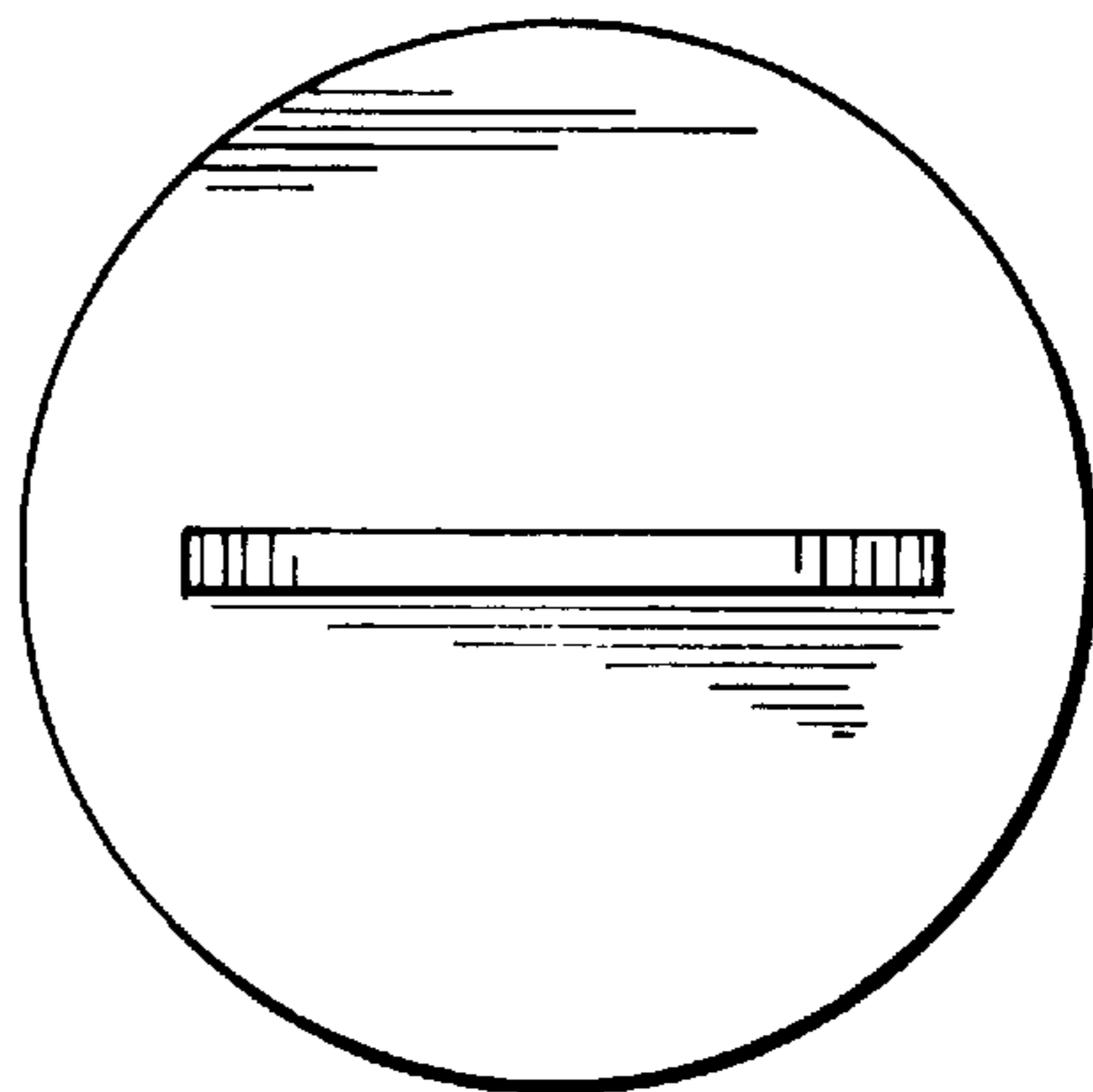

FIG. 16

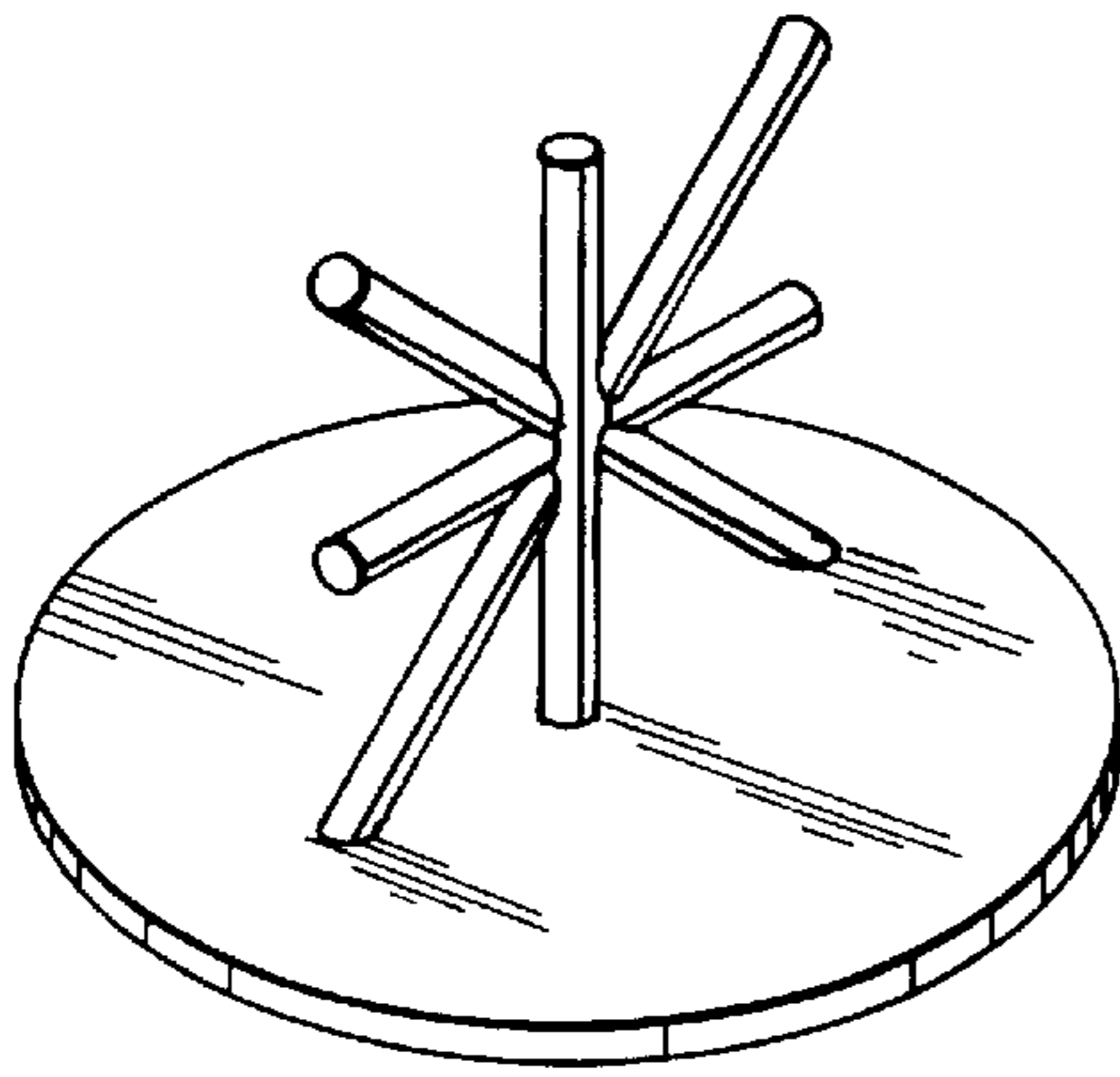

FIG. 17

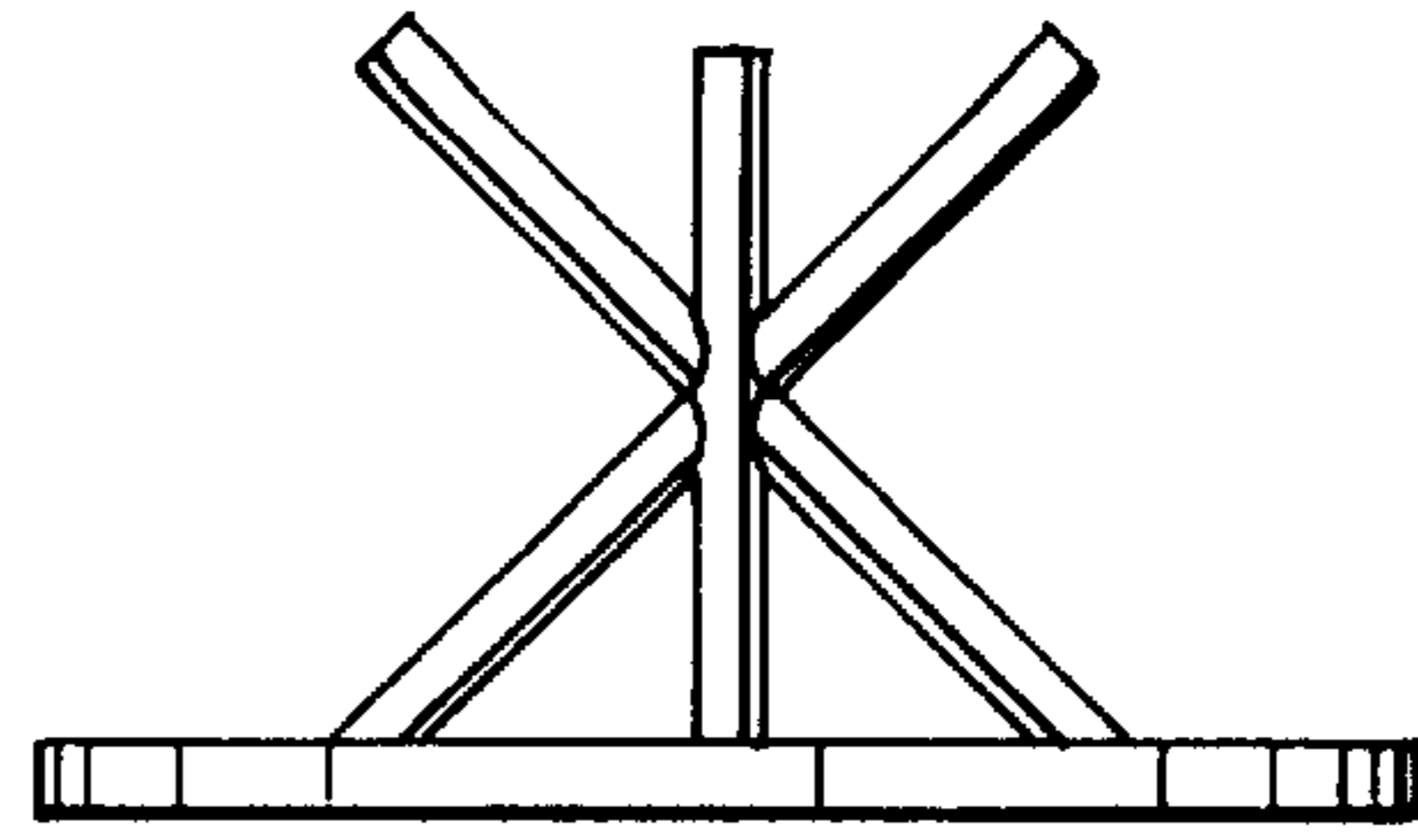

FIG. 18

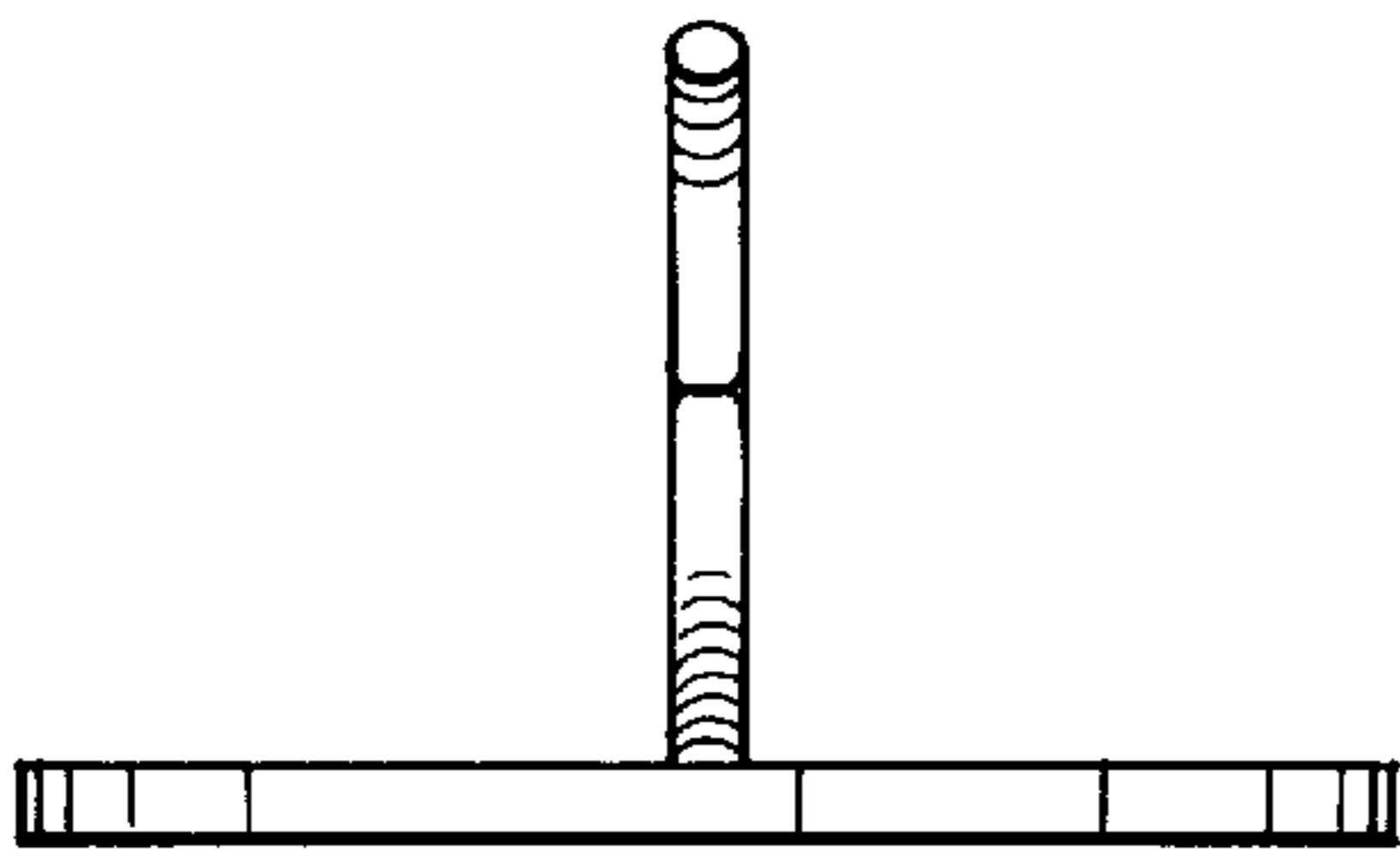

FIG. 19

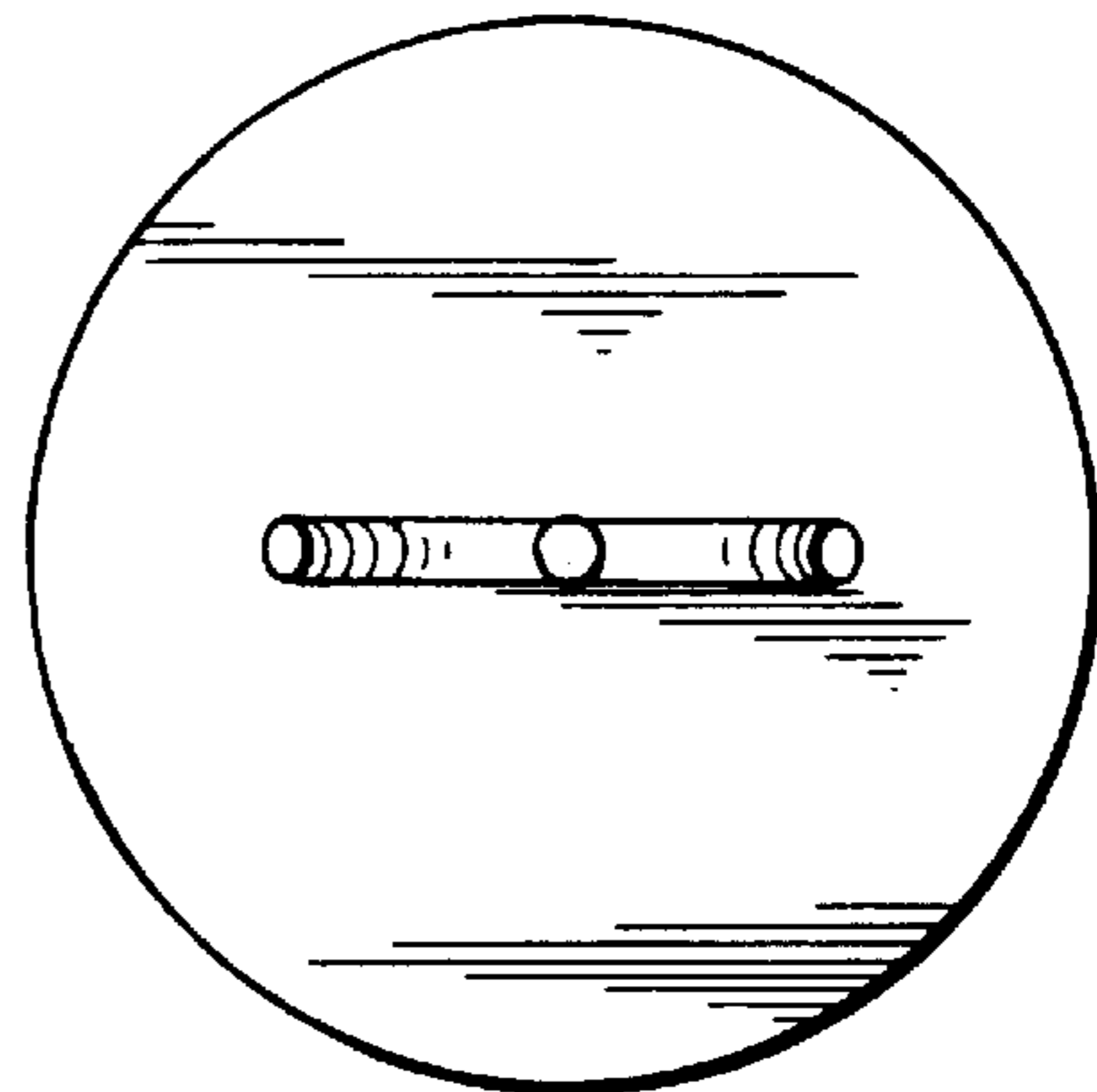

FIG. 20

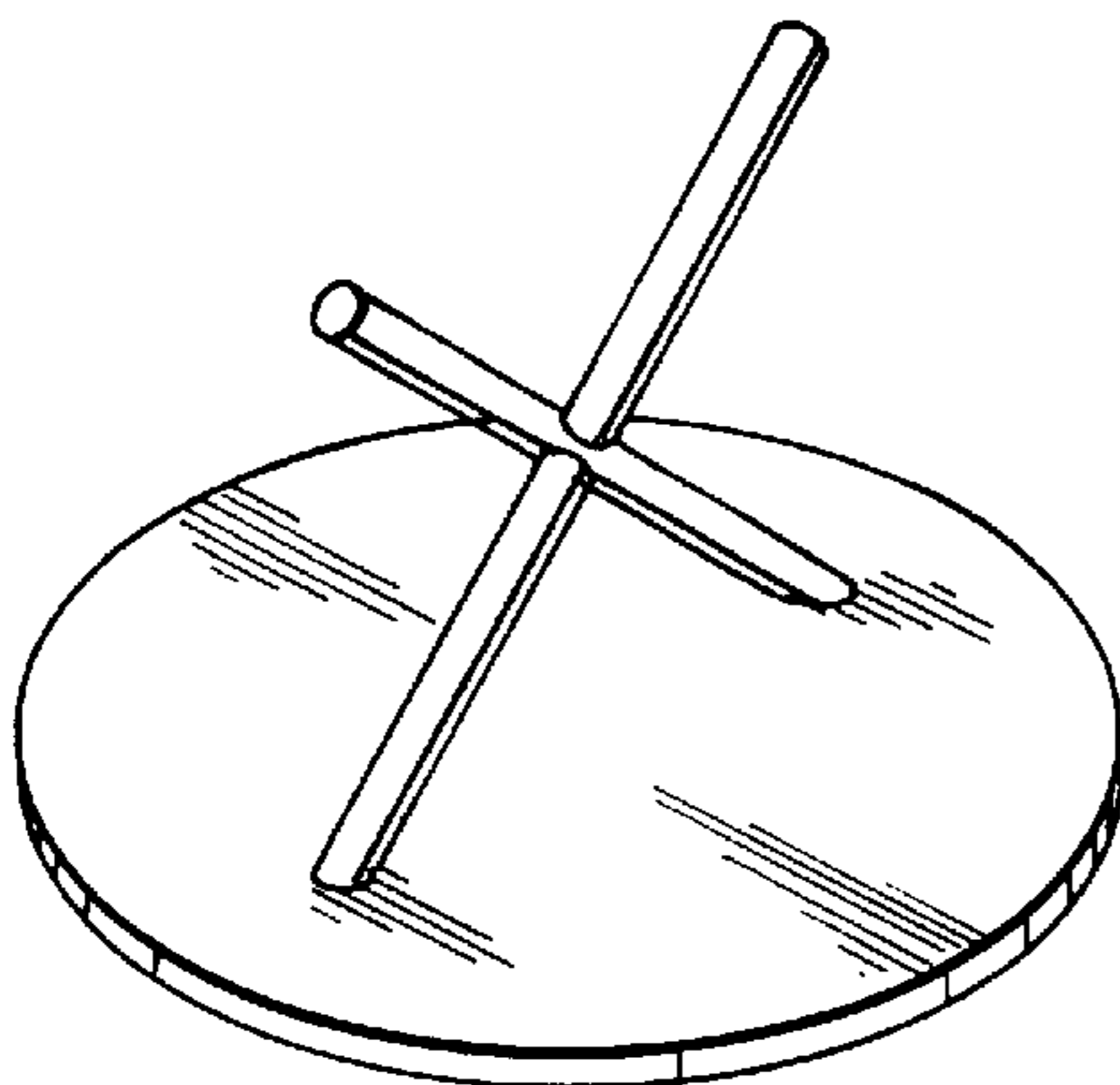

FIG. 21

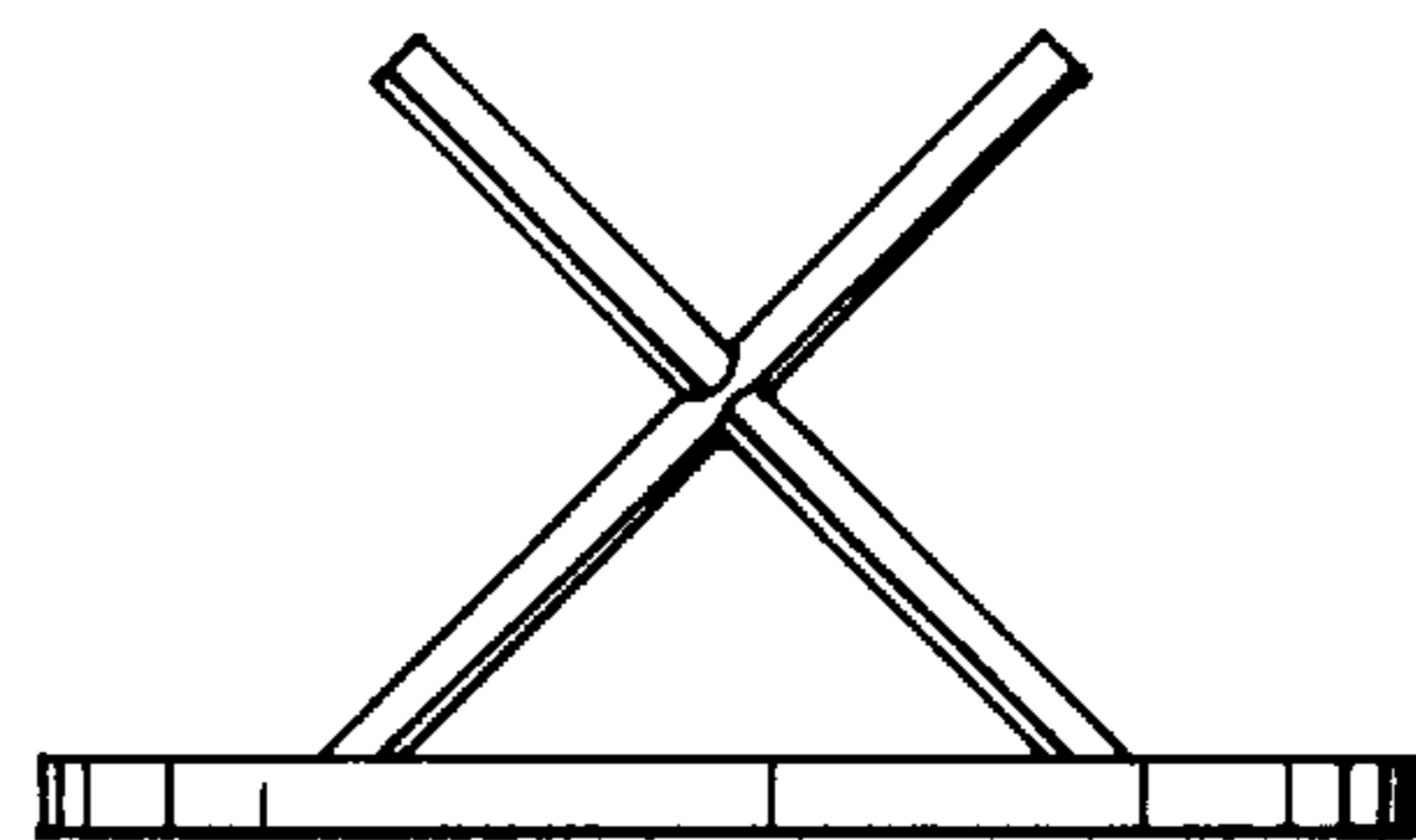

FIG. 22

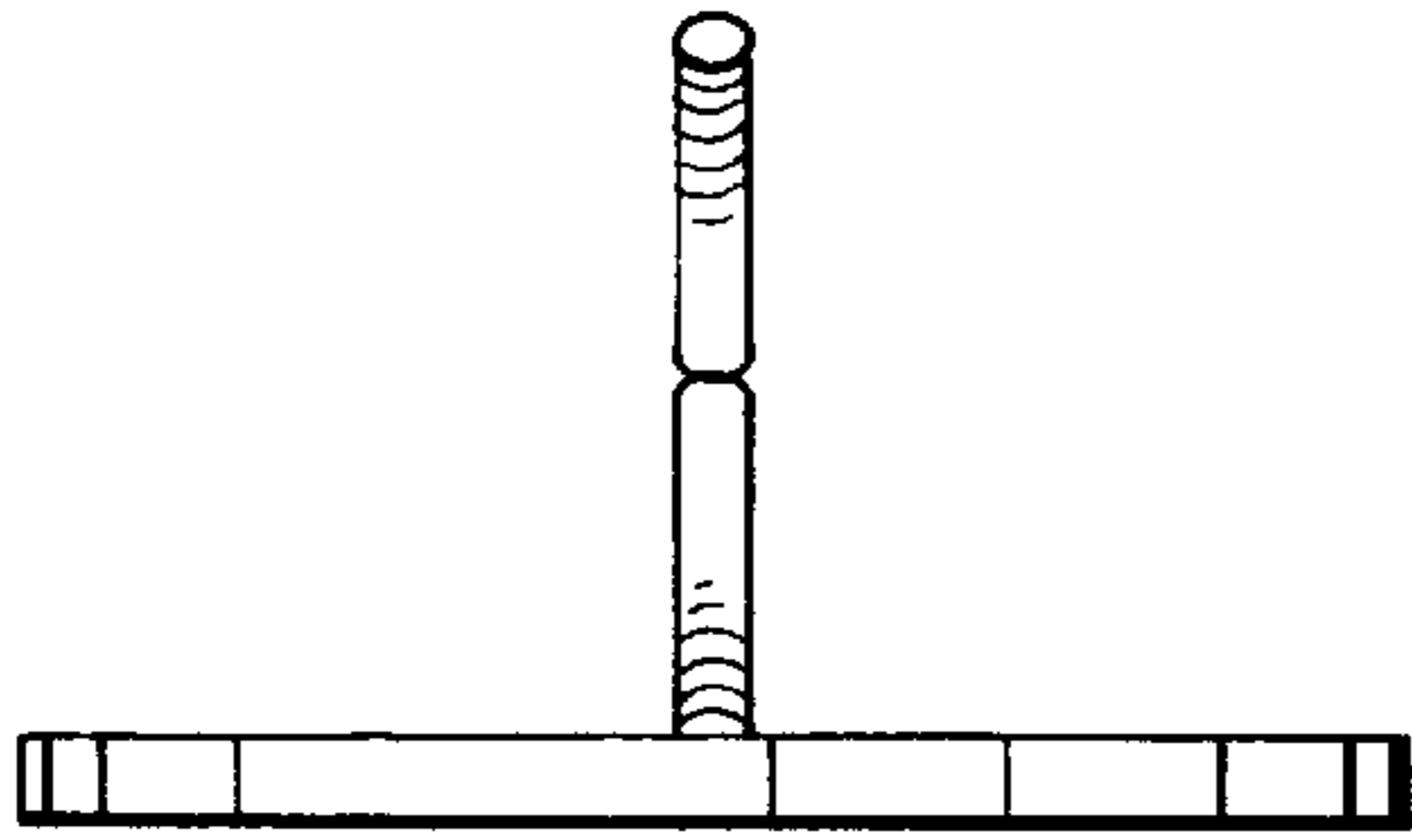

FIG. 23

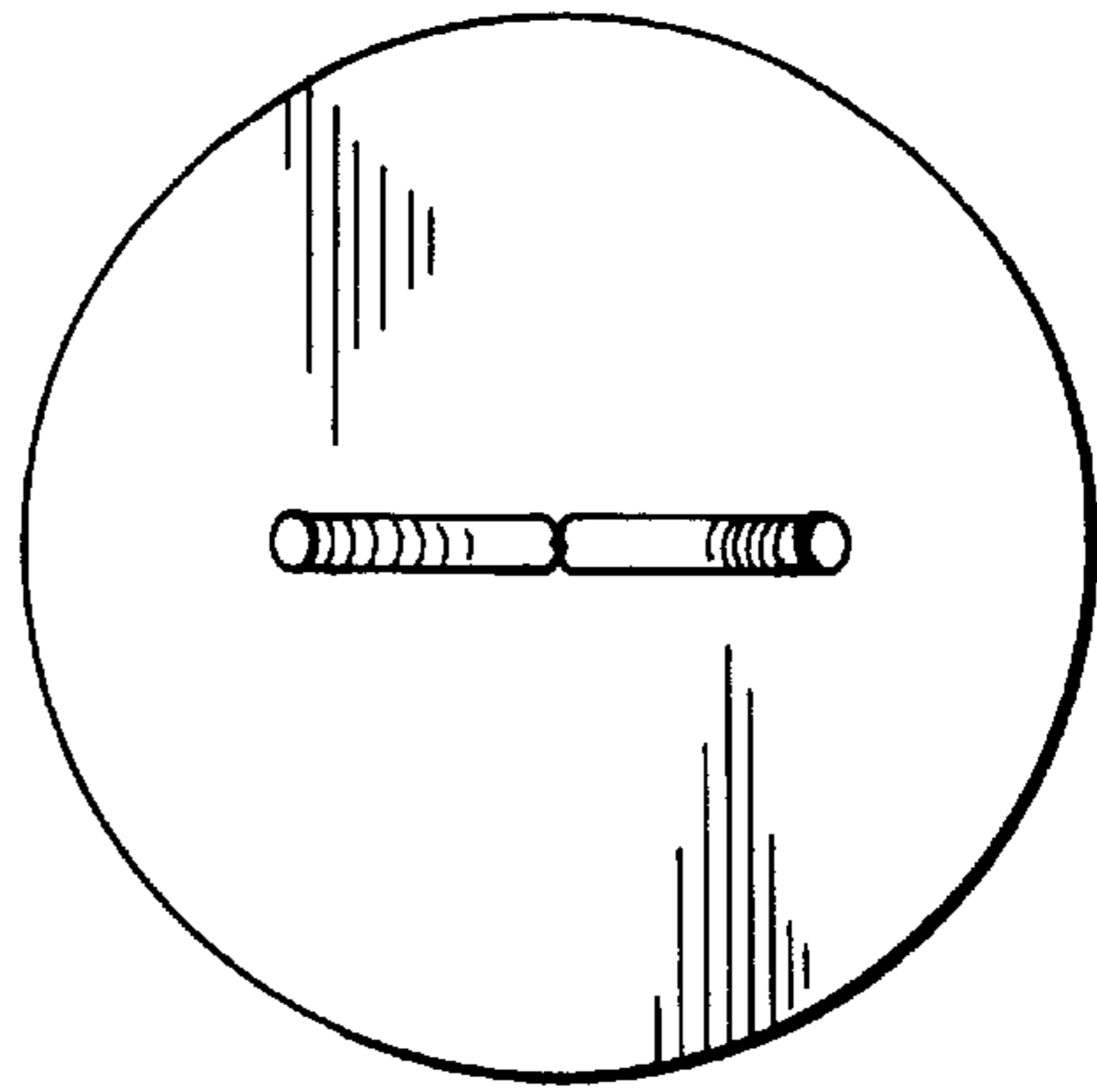

FIG. 24

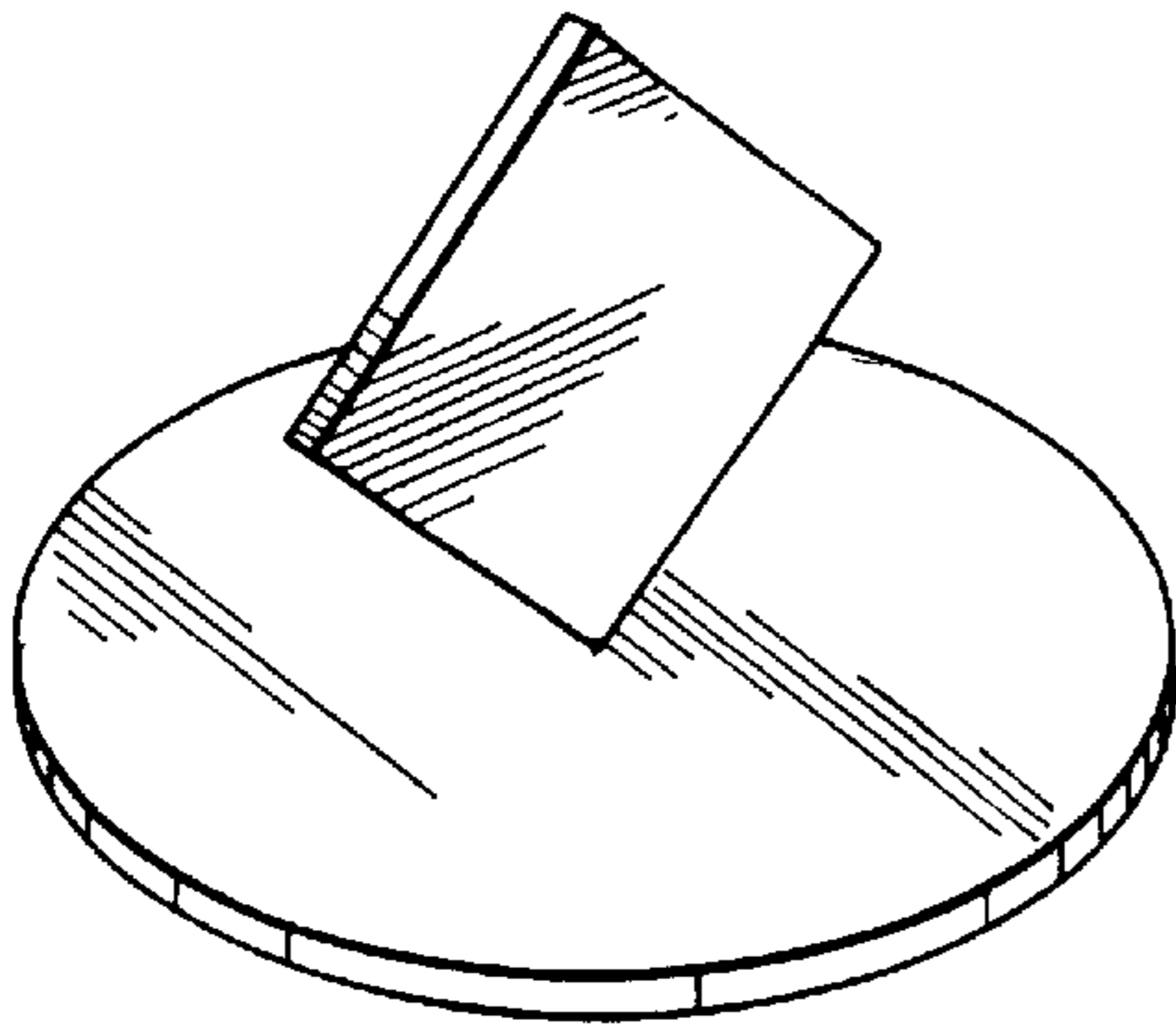

FIG. 25

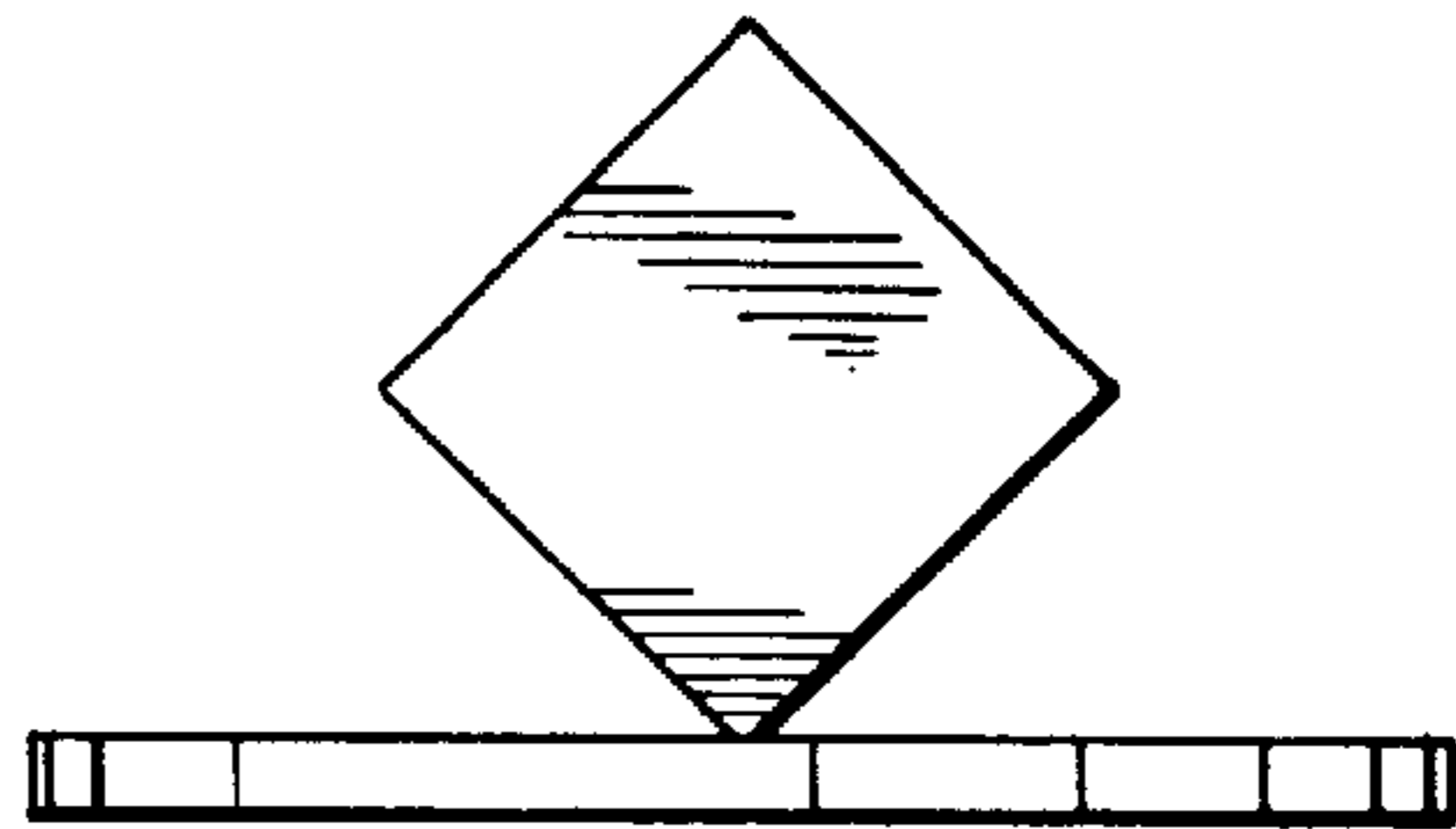

FIG. 26

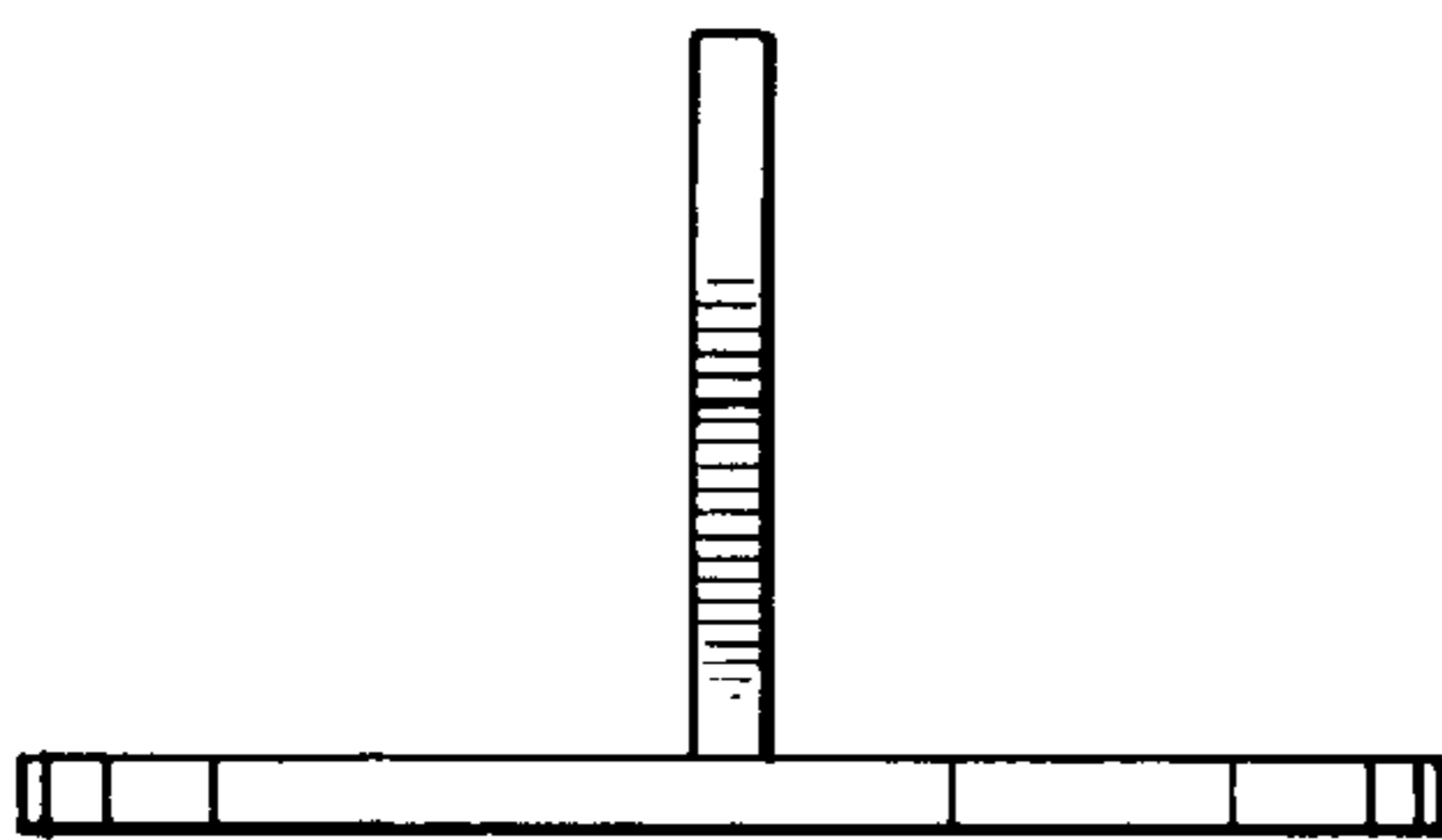

FIG. 27

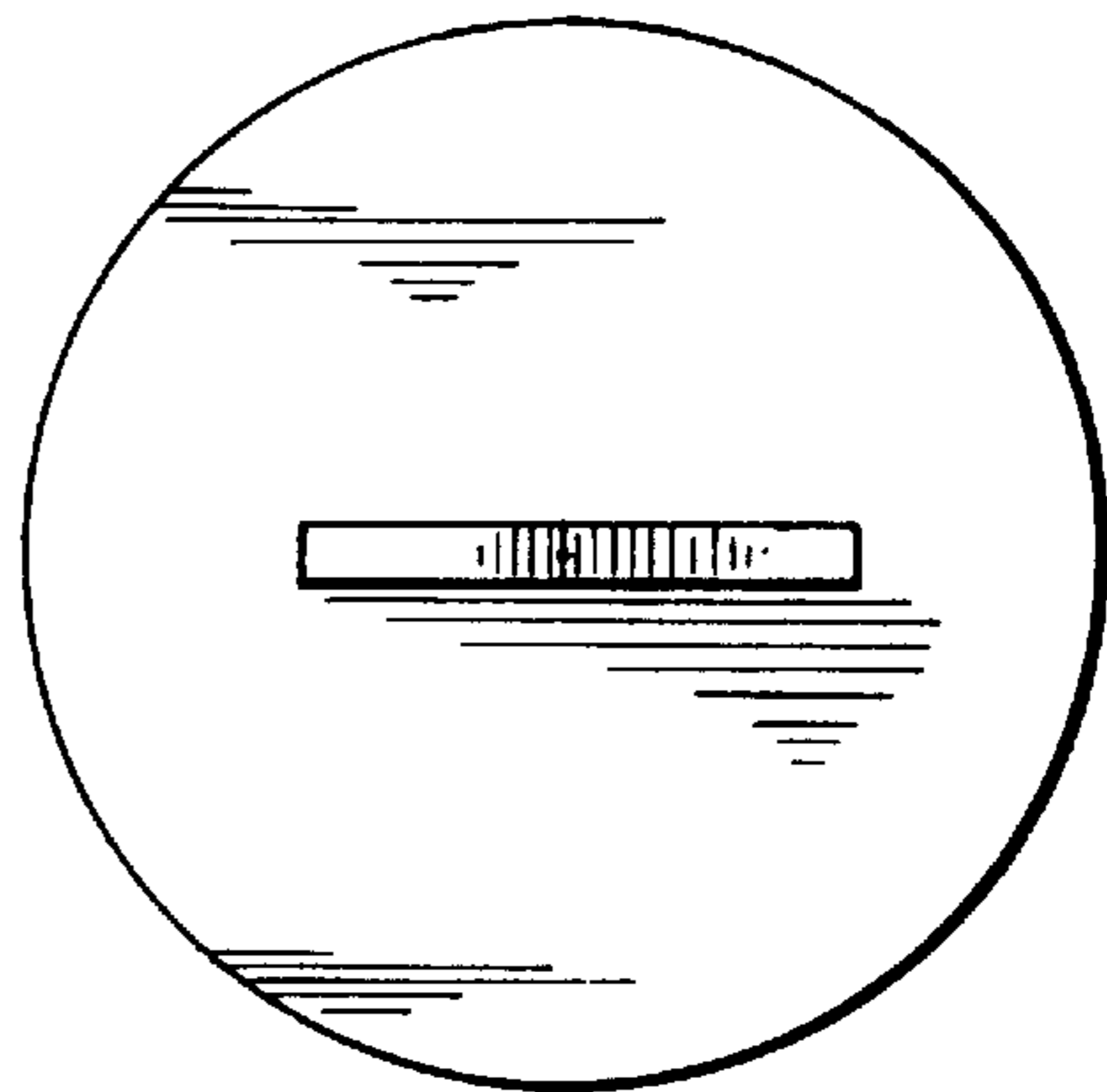

FIG. 28

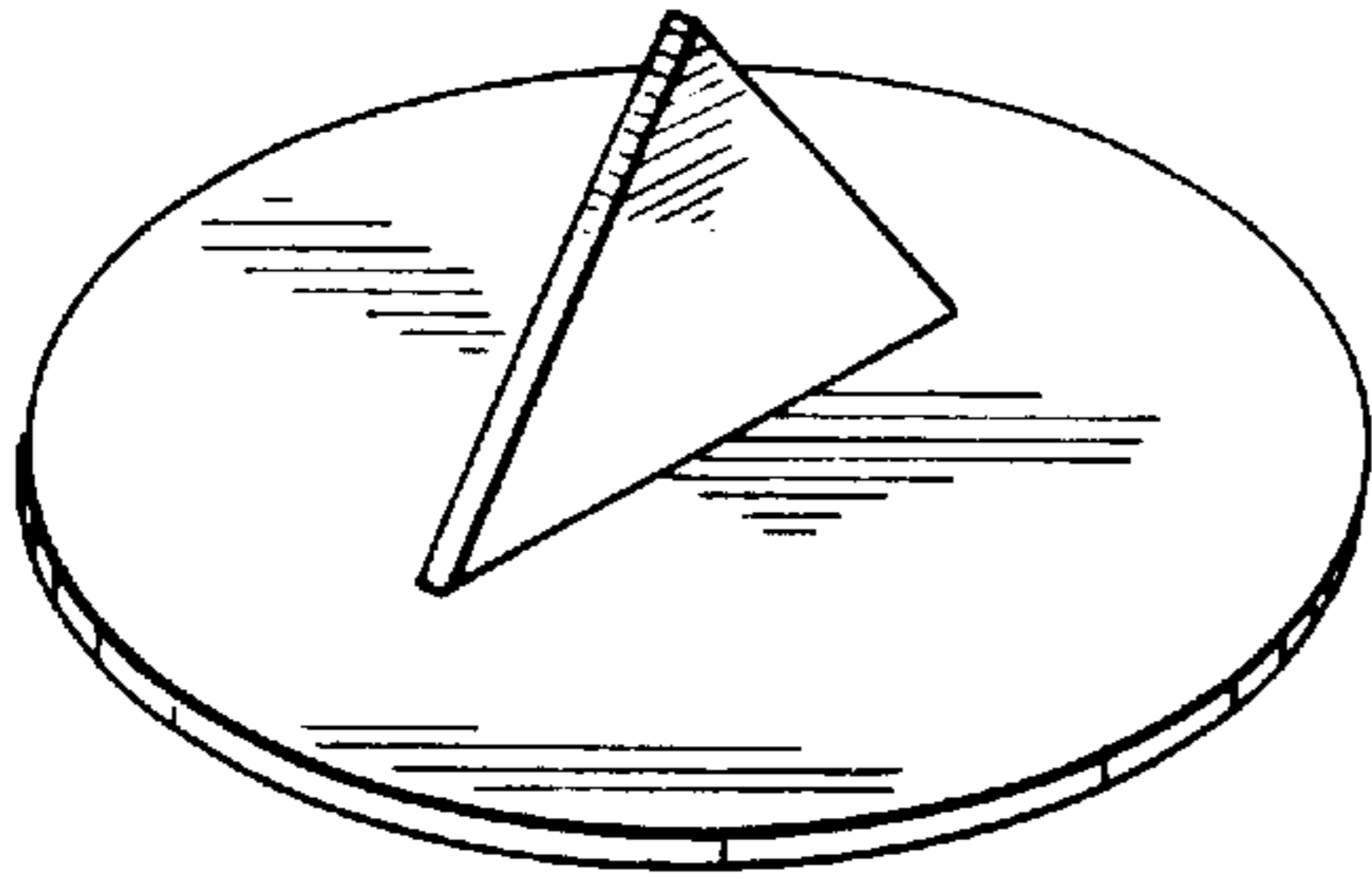

FIG. 29

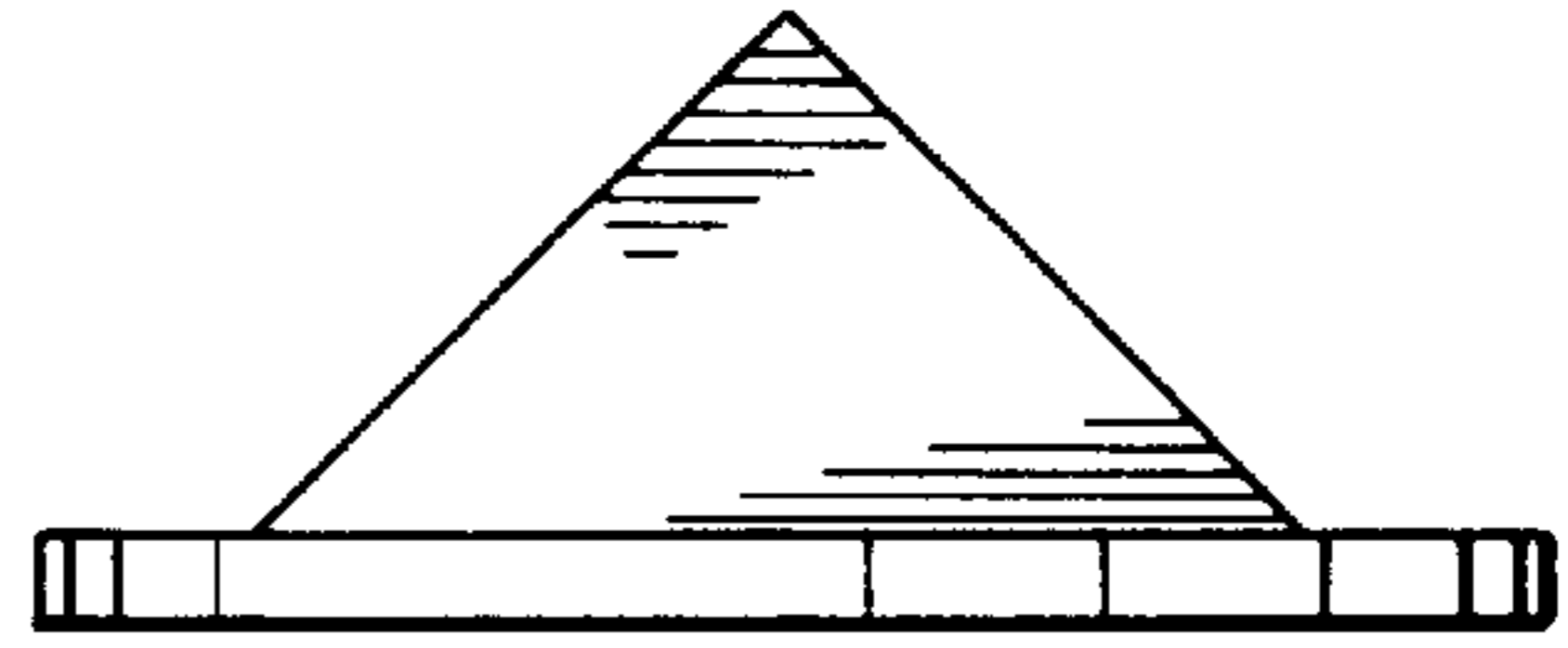

FIG. 30

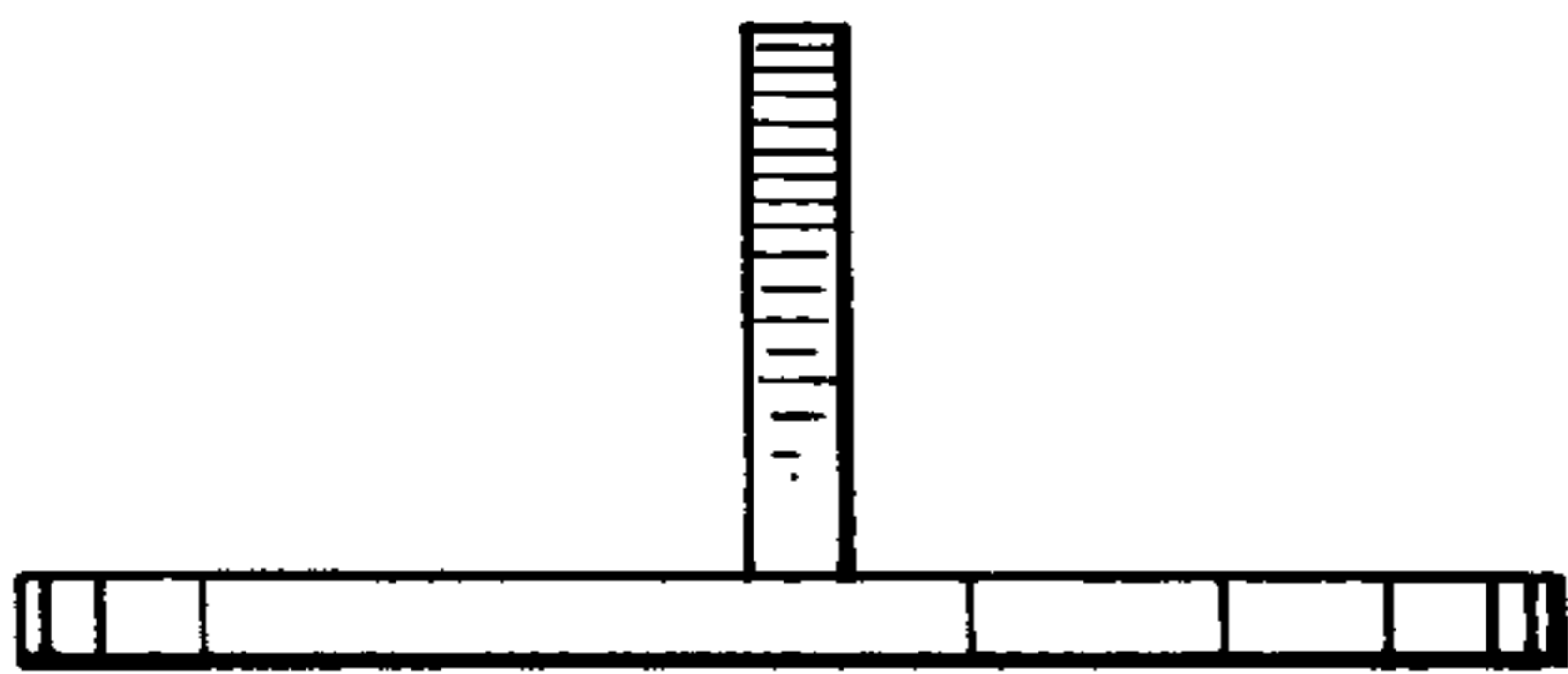

FIG. 31

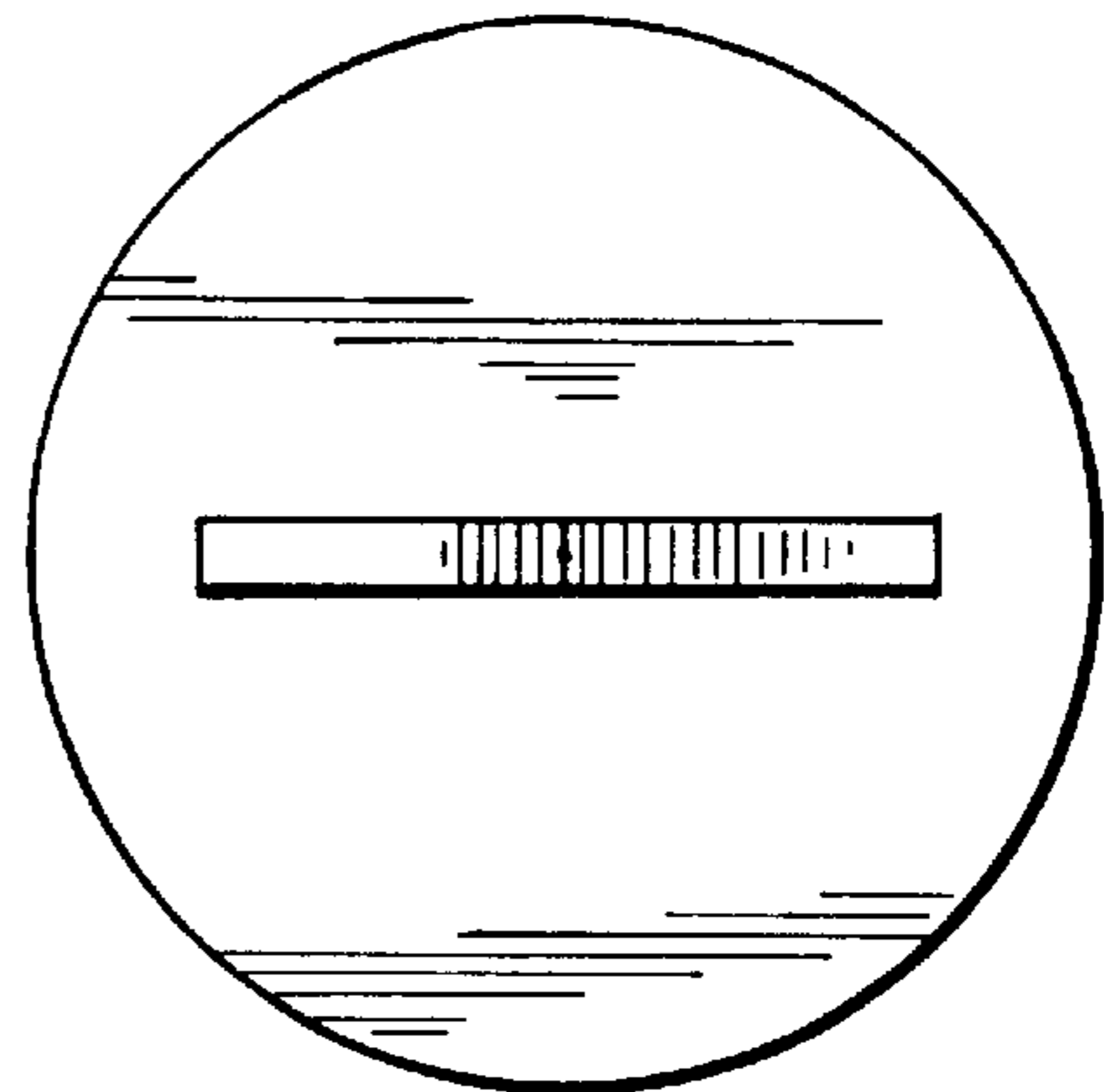

FIG. 32

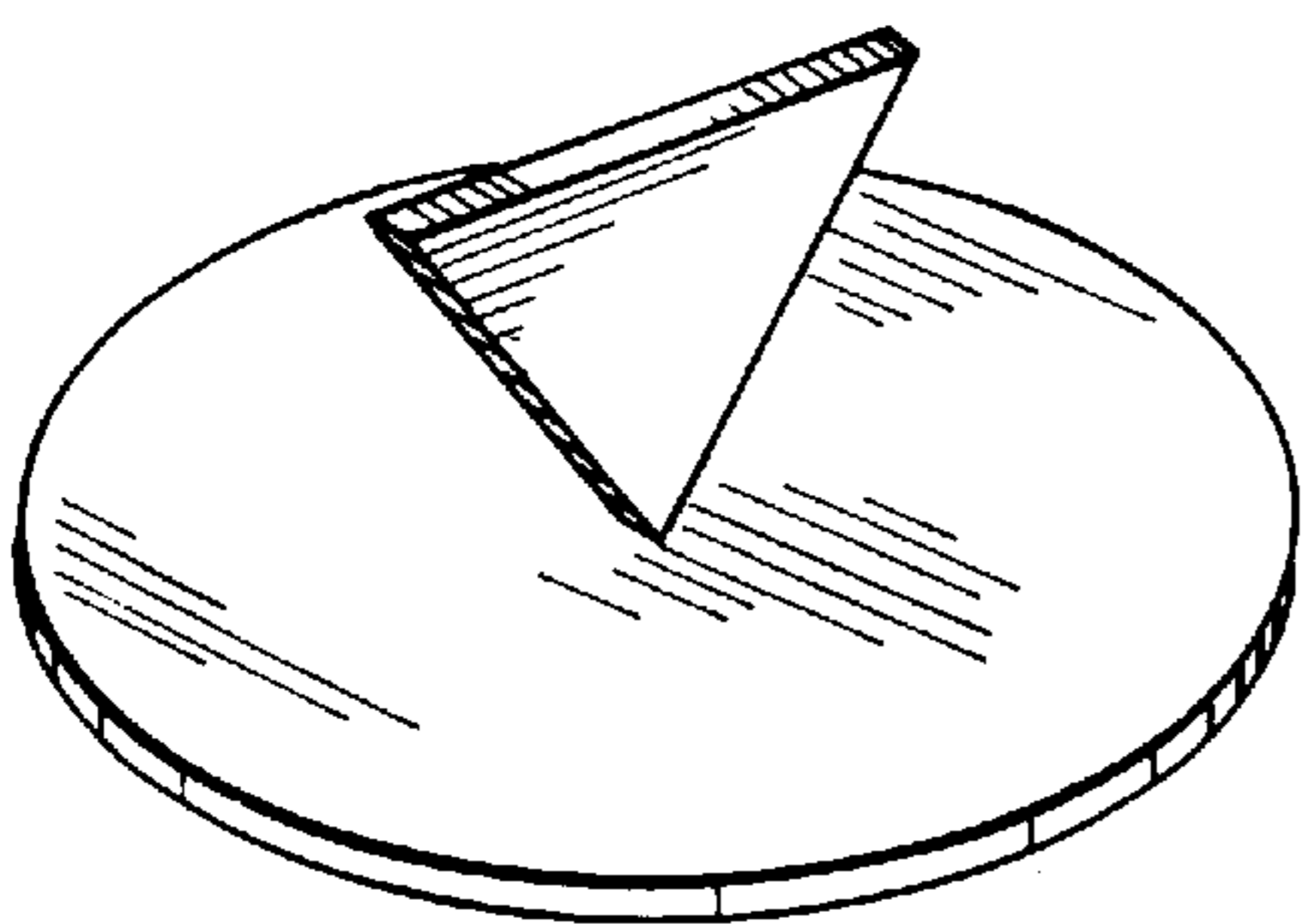

FIG. 33

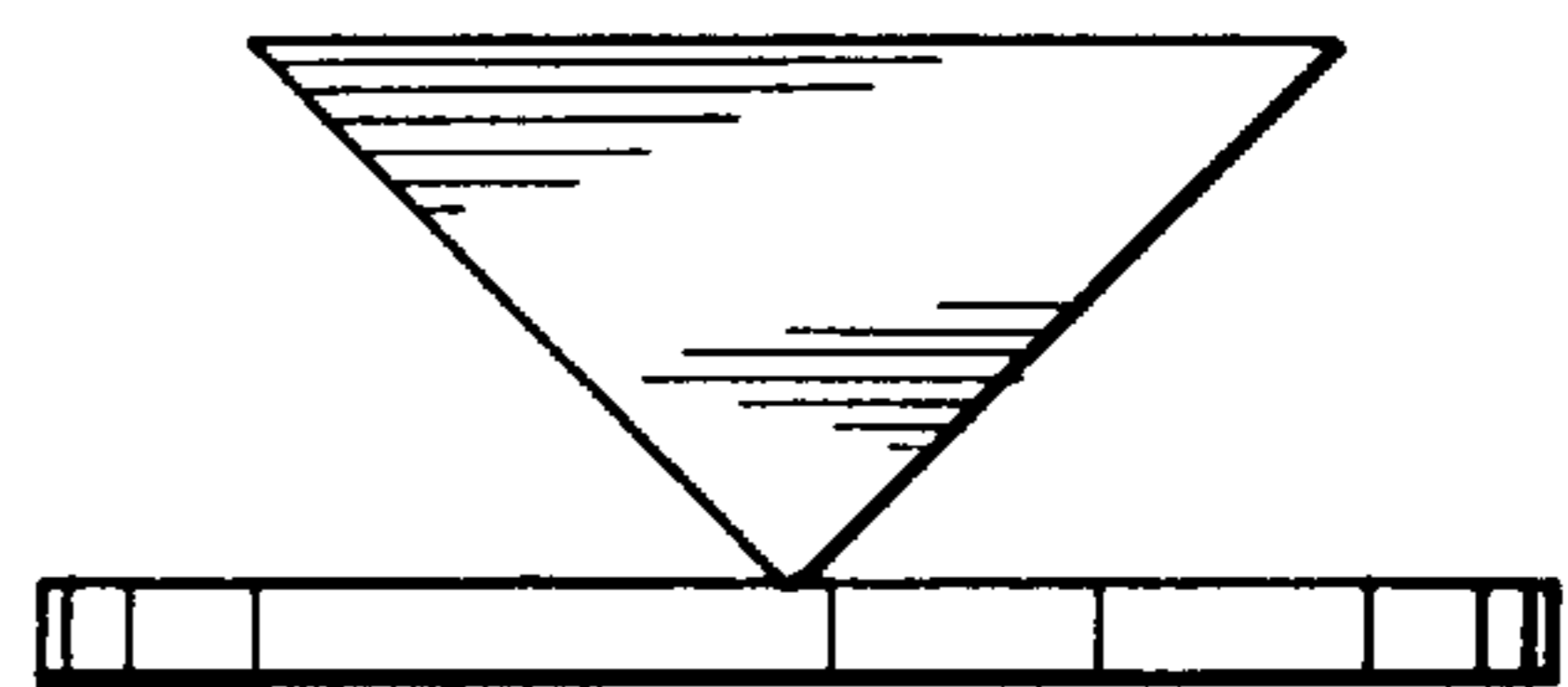

FIG. 34

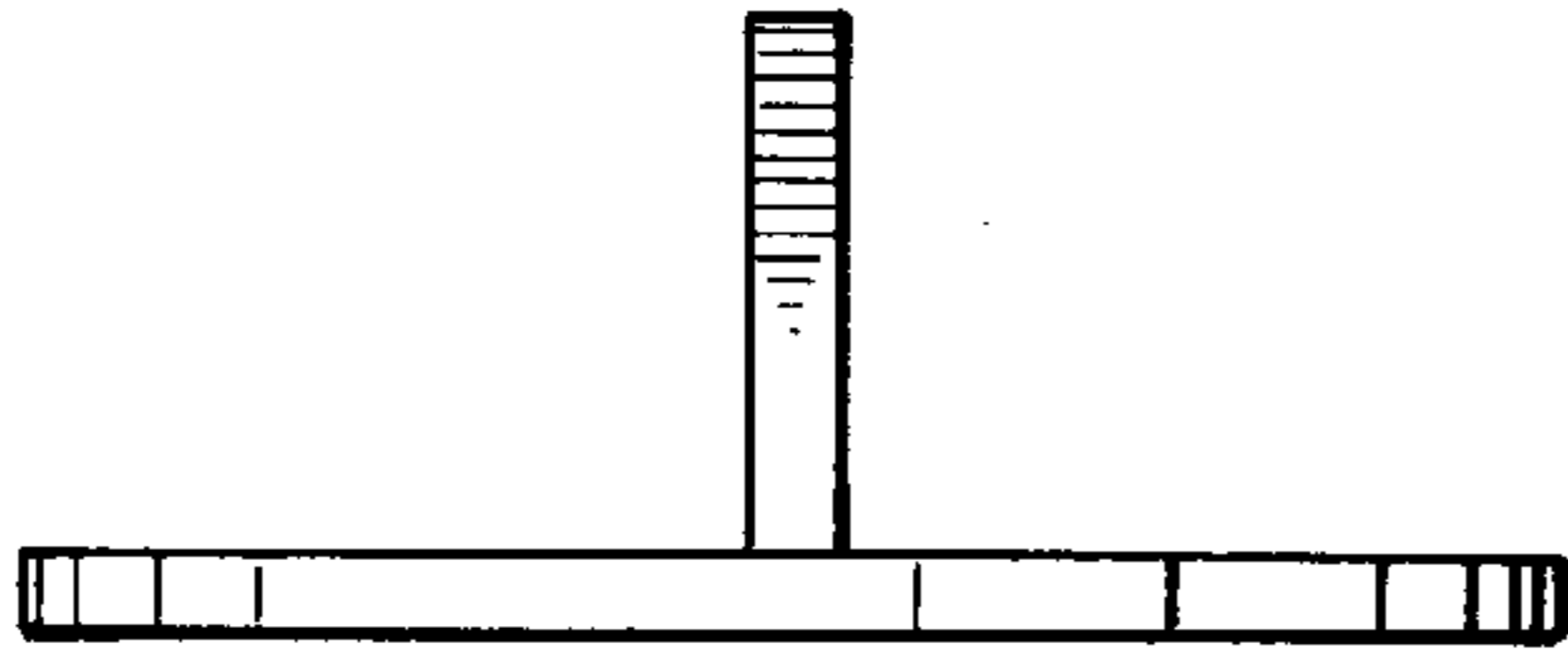

FIG. 35

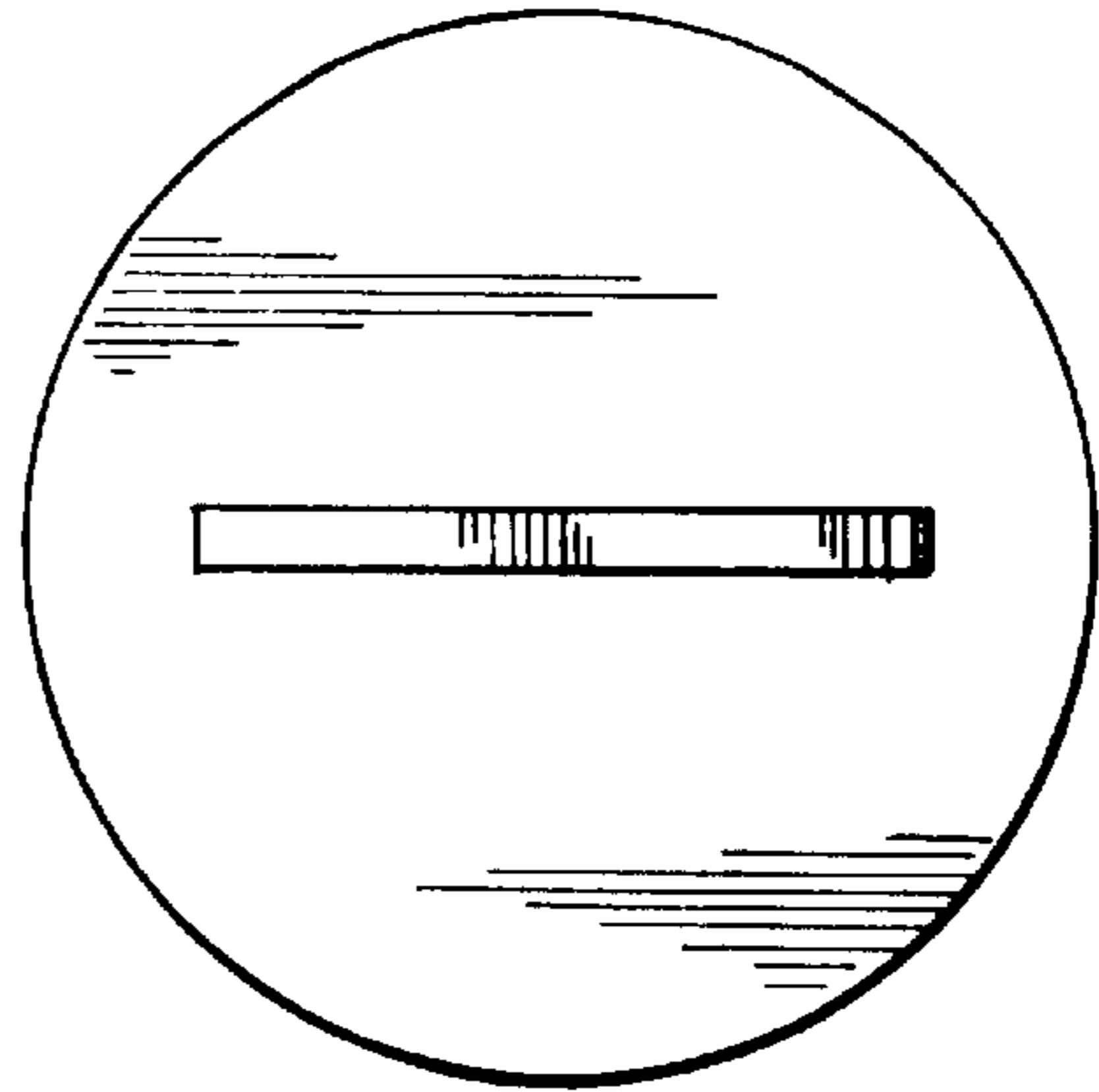

FIG. 36

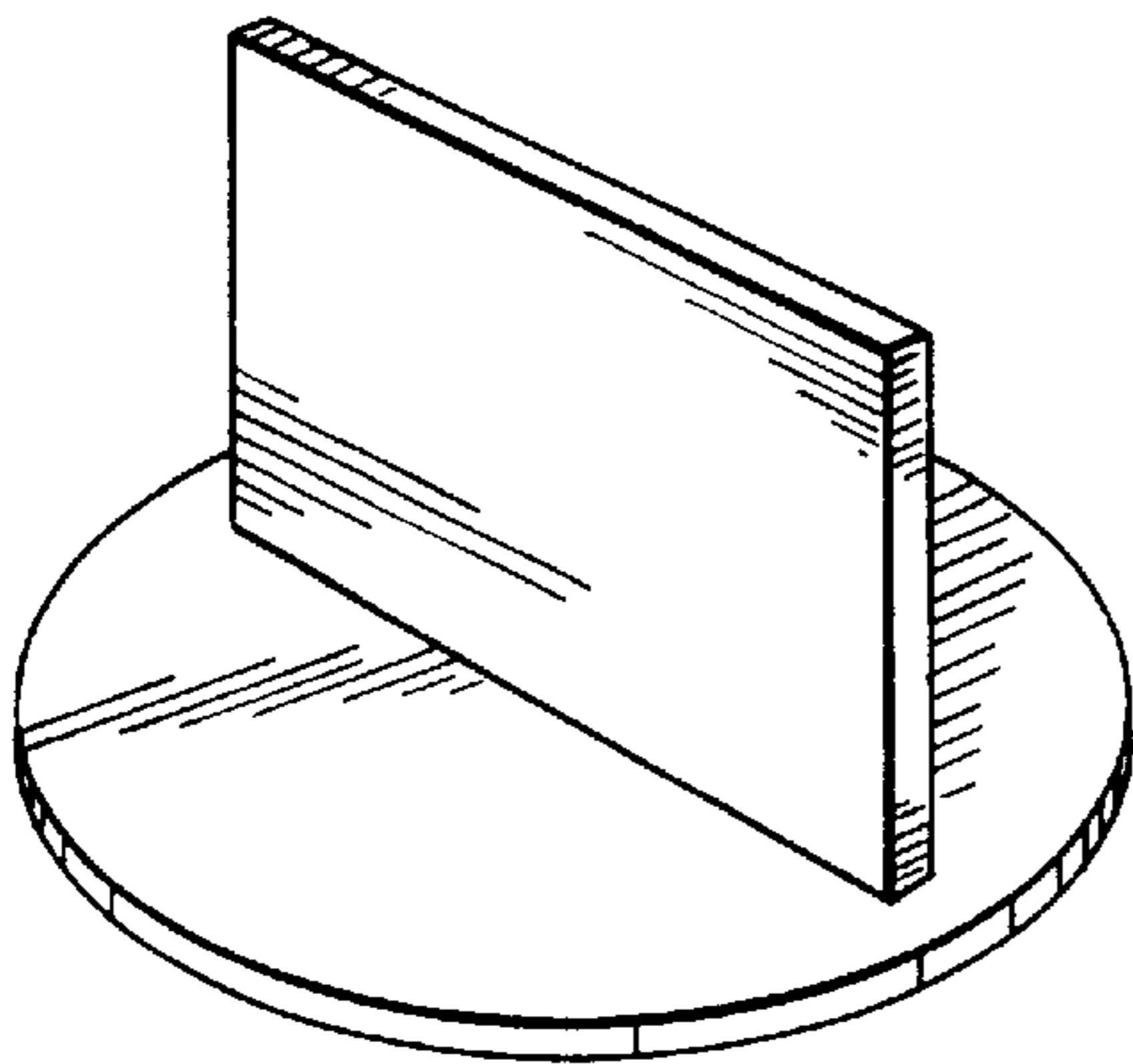

FIG. 37

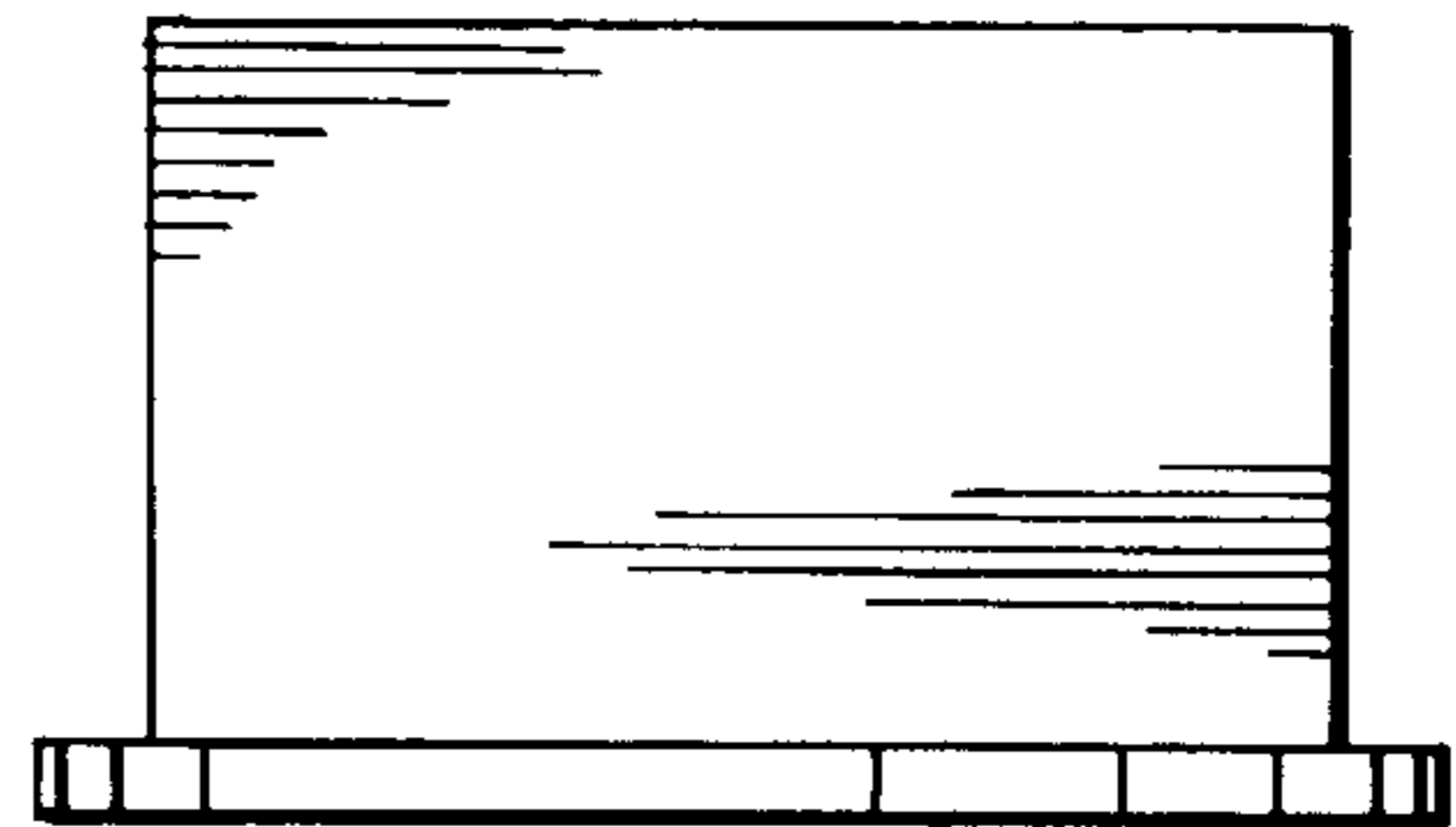

FIG. 38

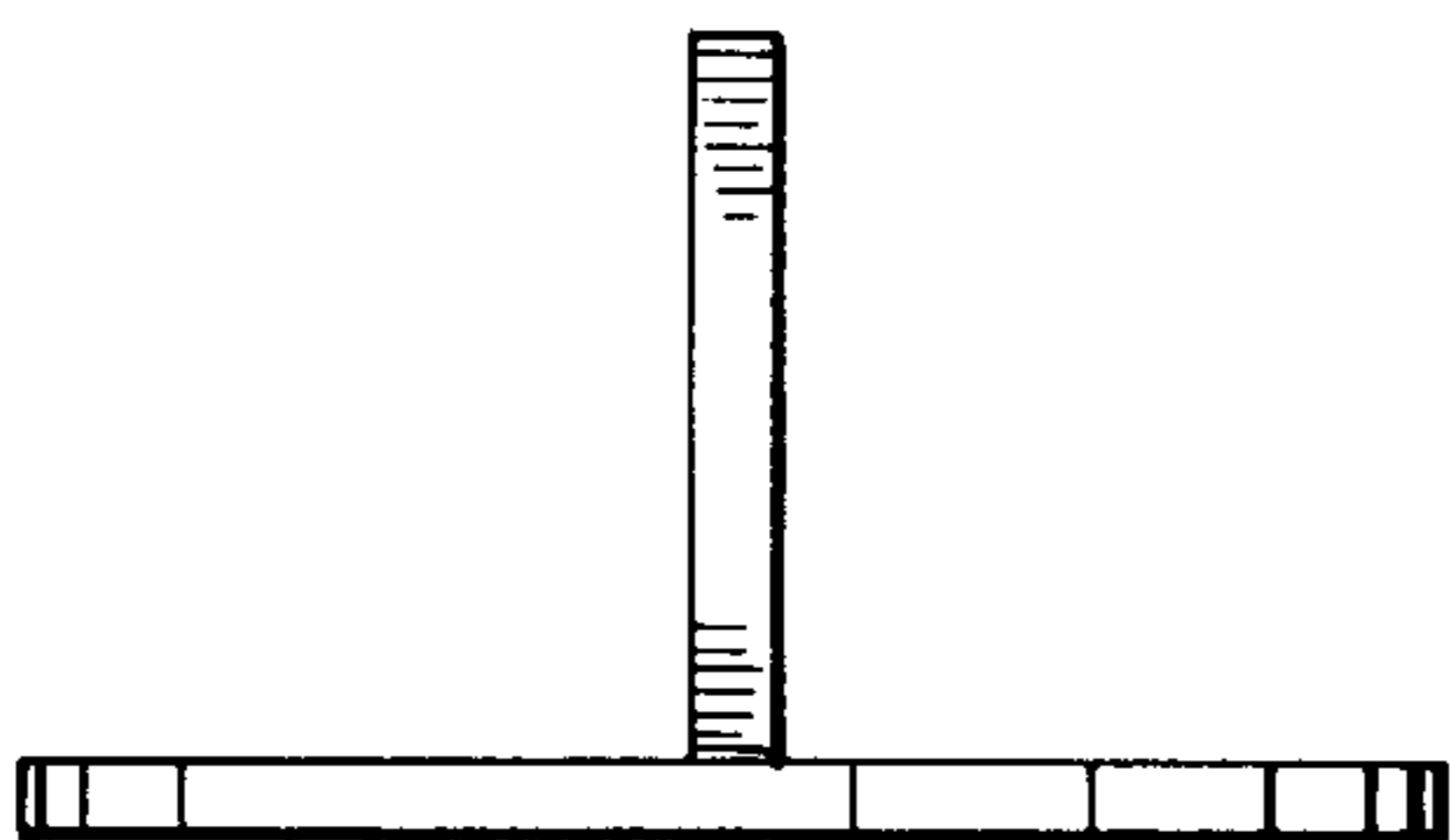

FIG. 39

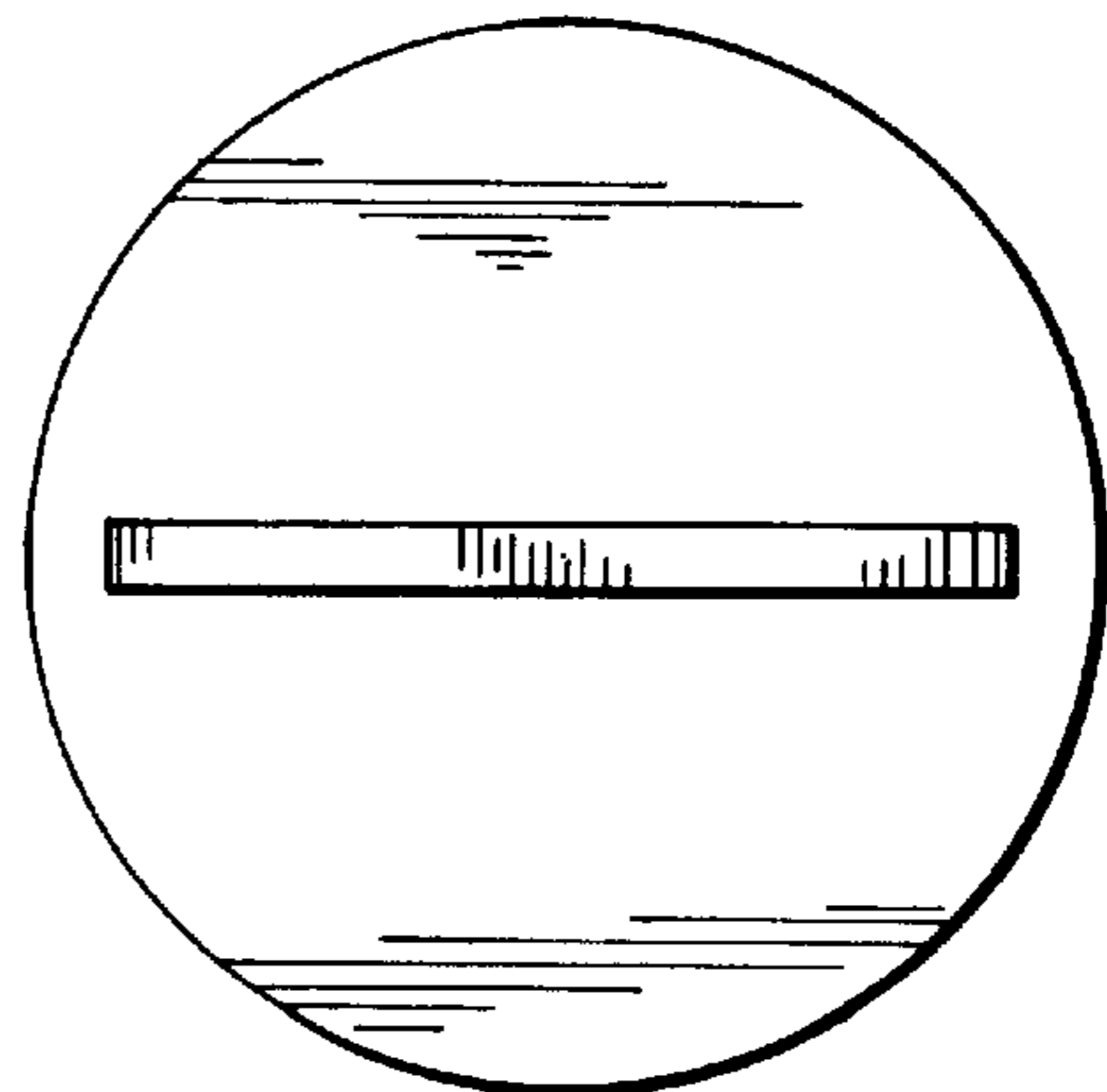

FIG. 40

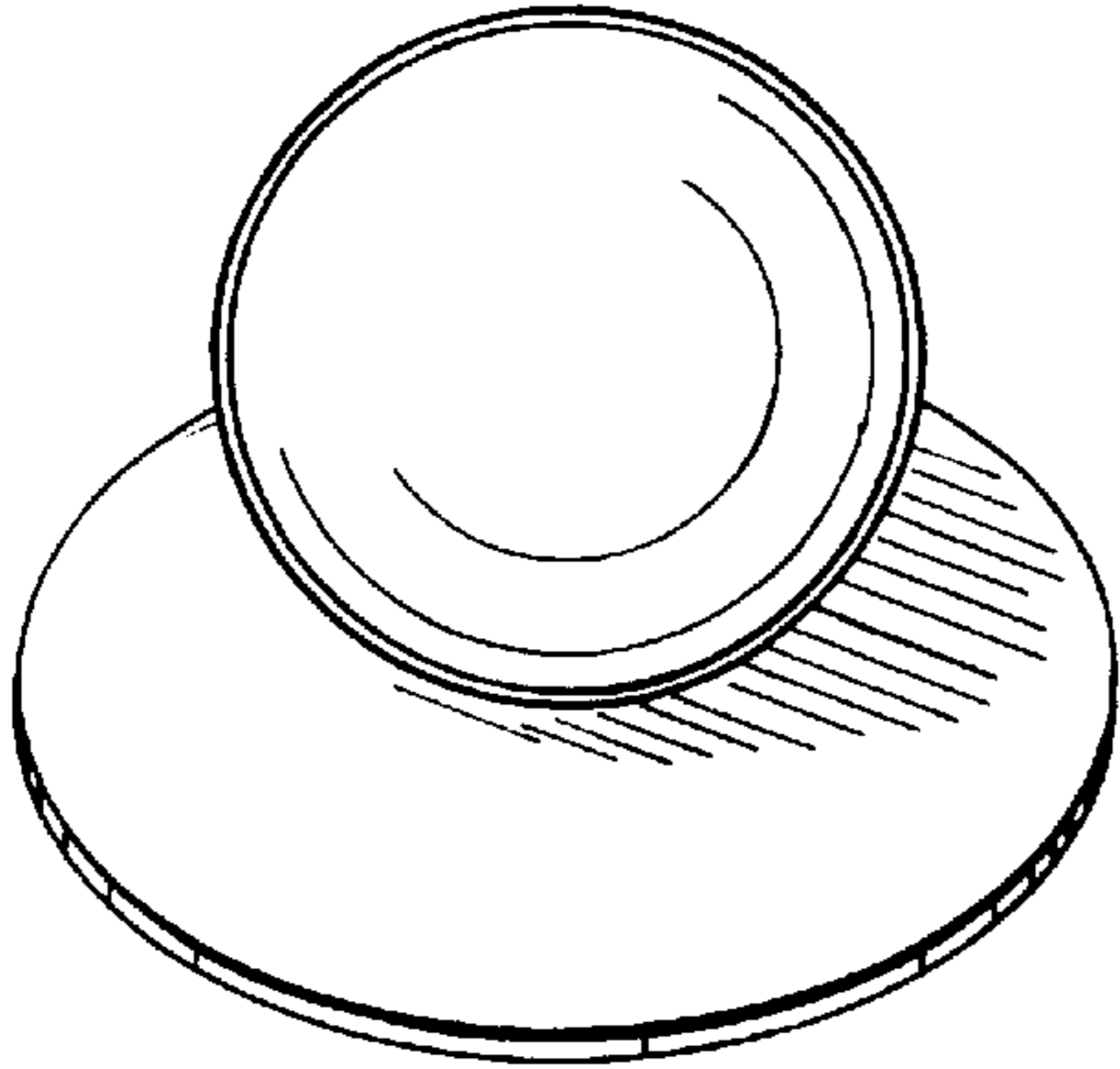

FIG. 41

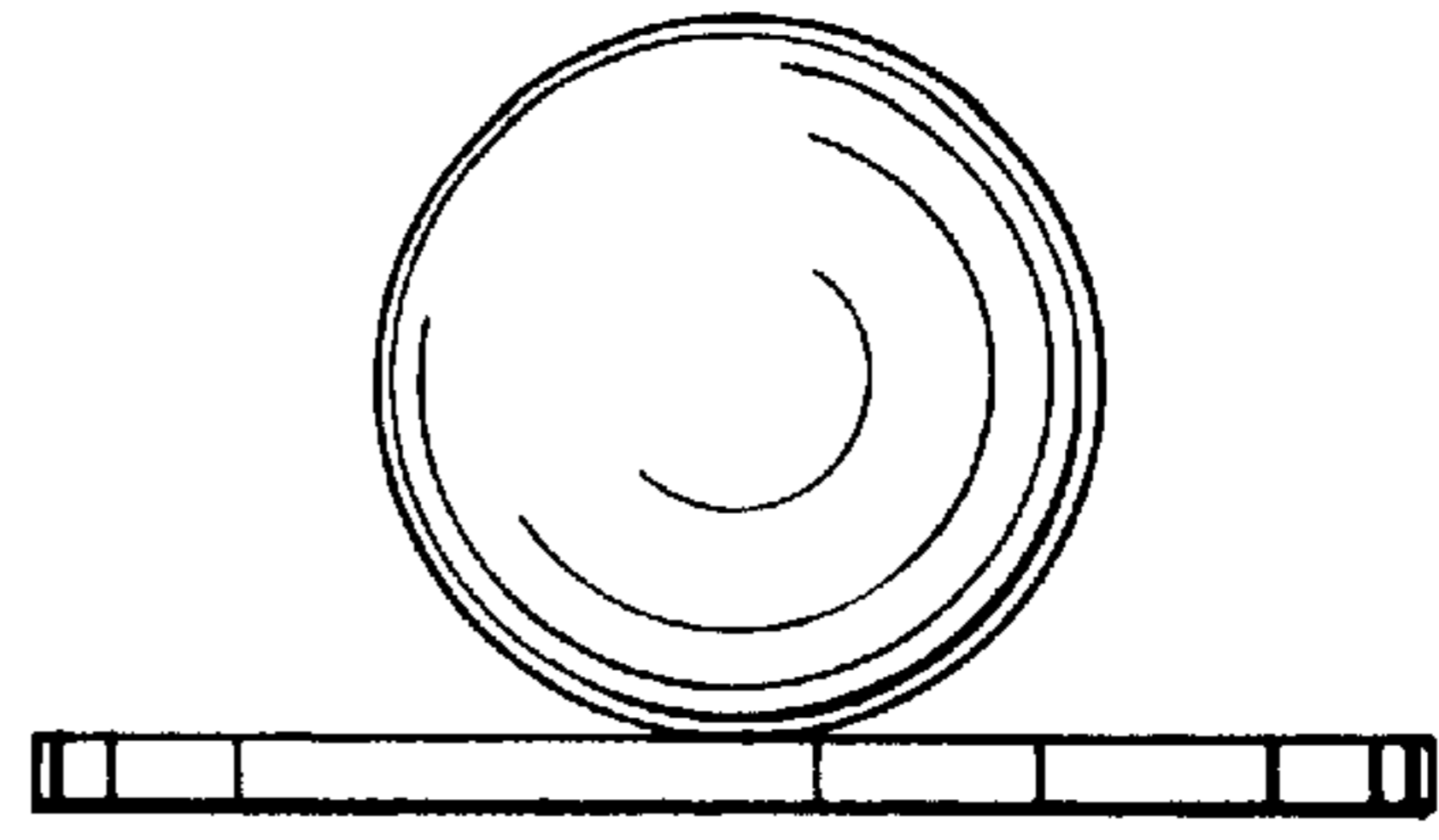

FIG. 42

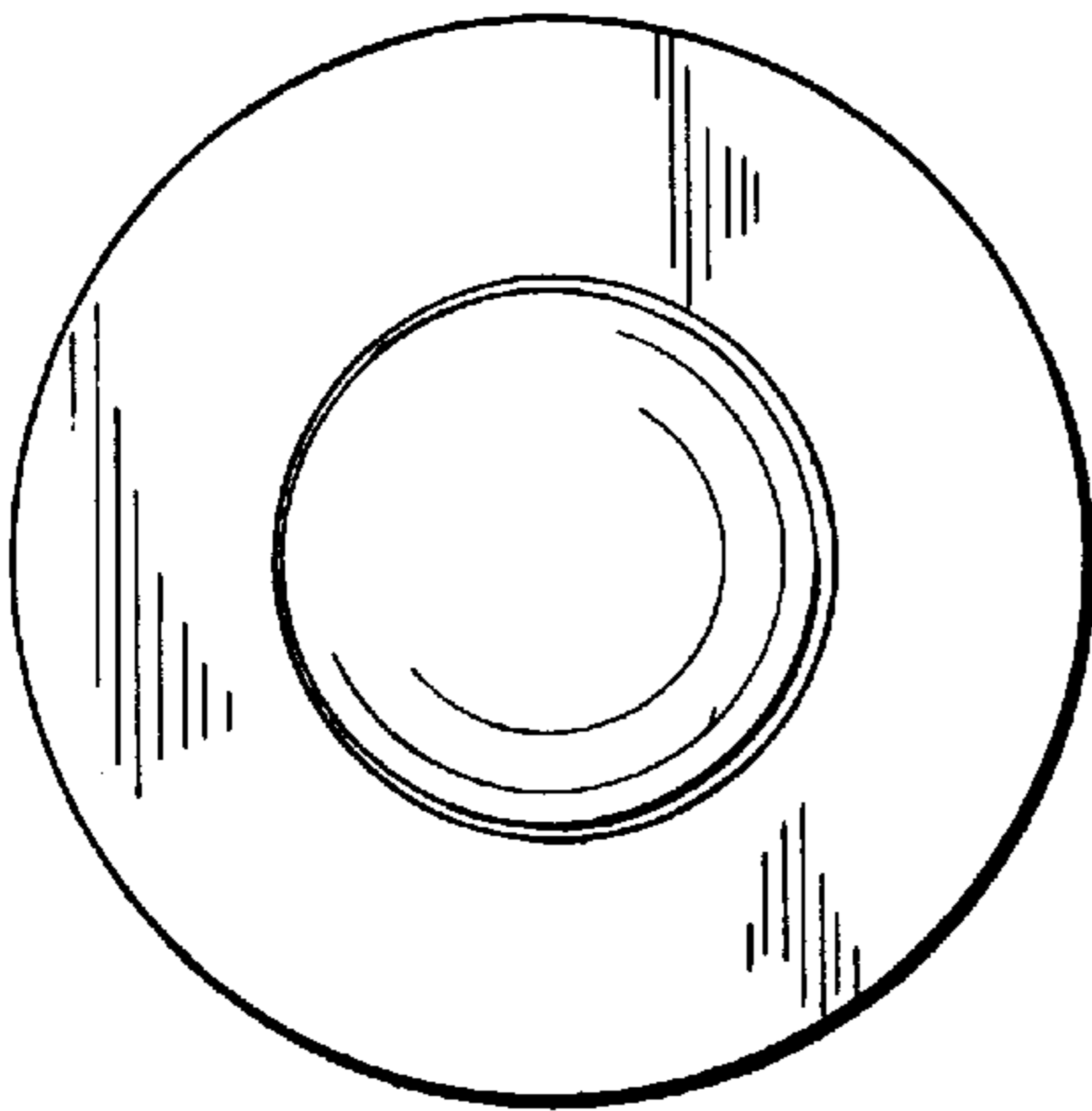

FIG. 43

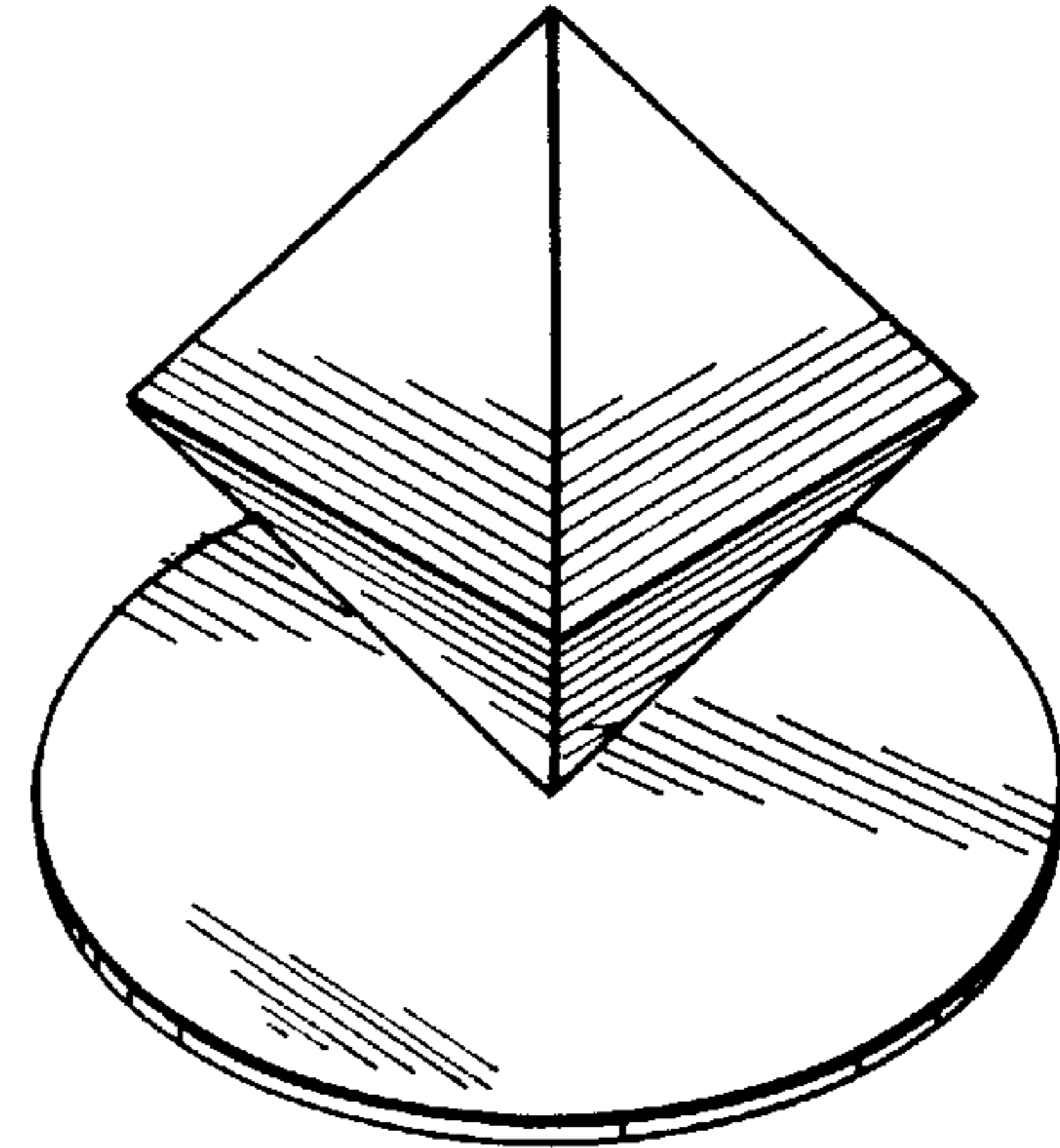

FIG. 45

FIG. 44

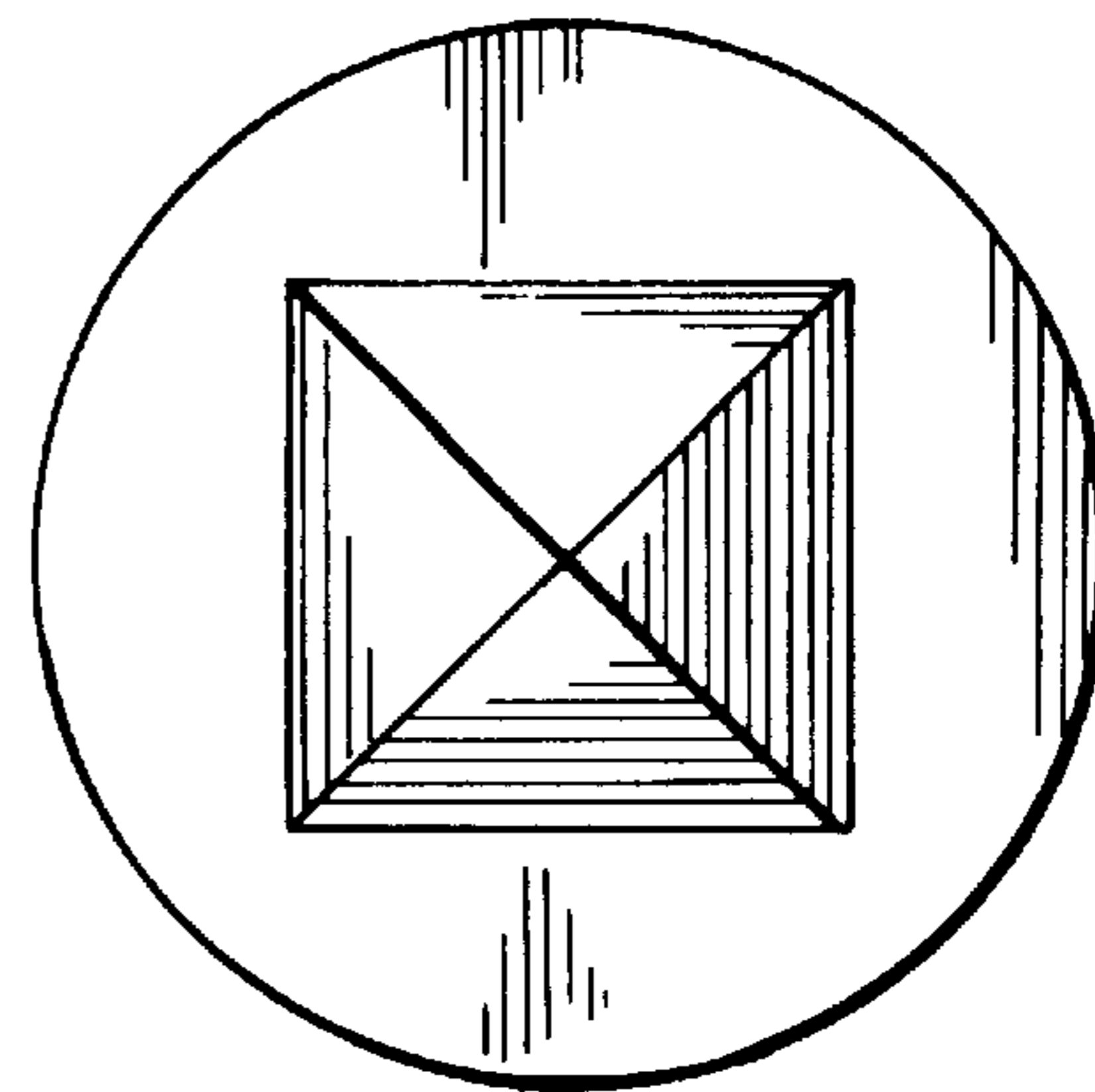
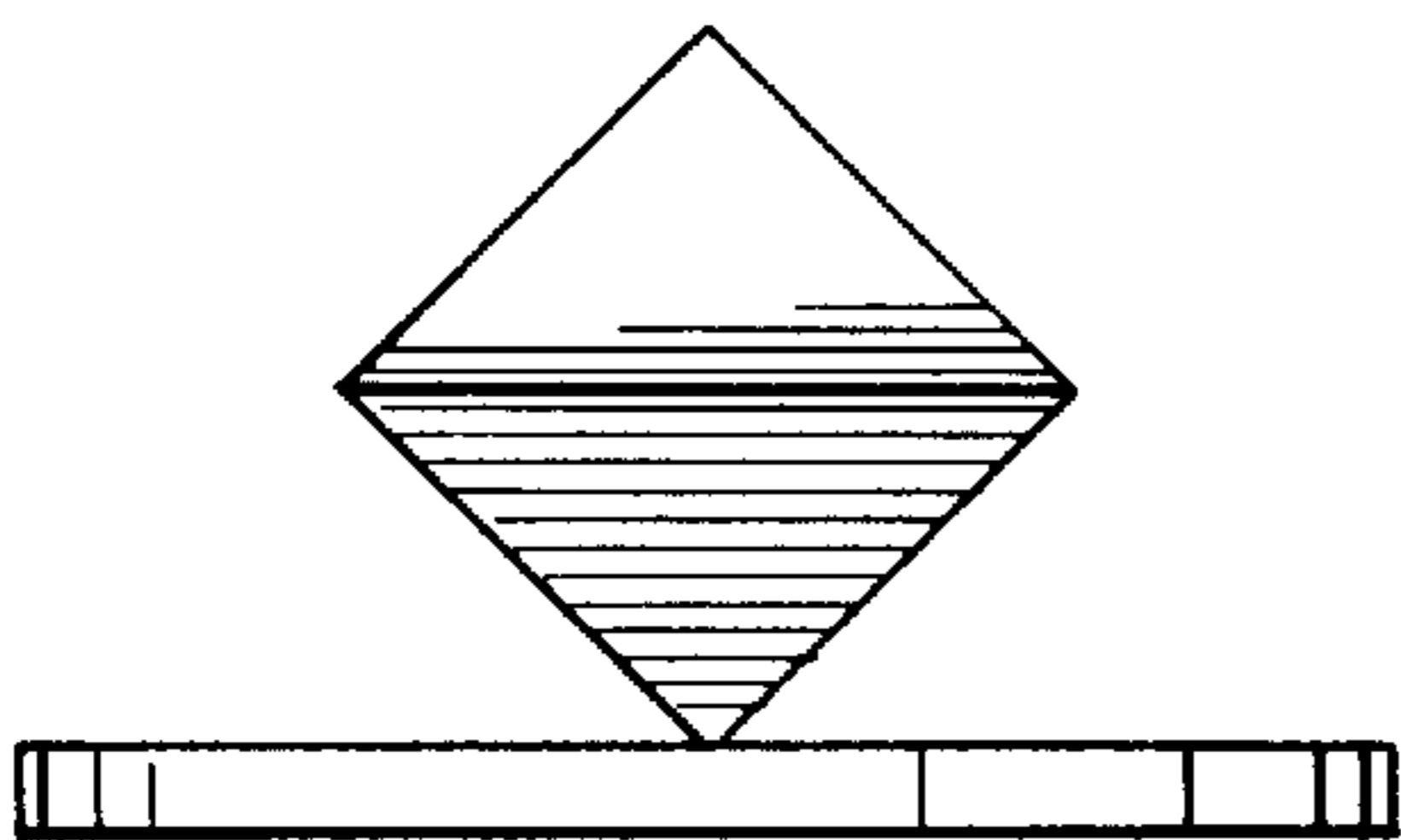

FIG. 46

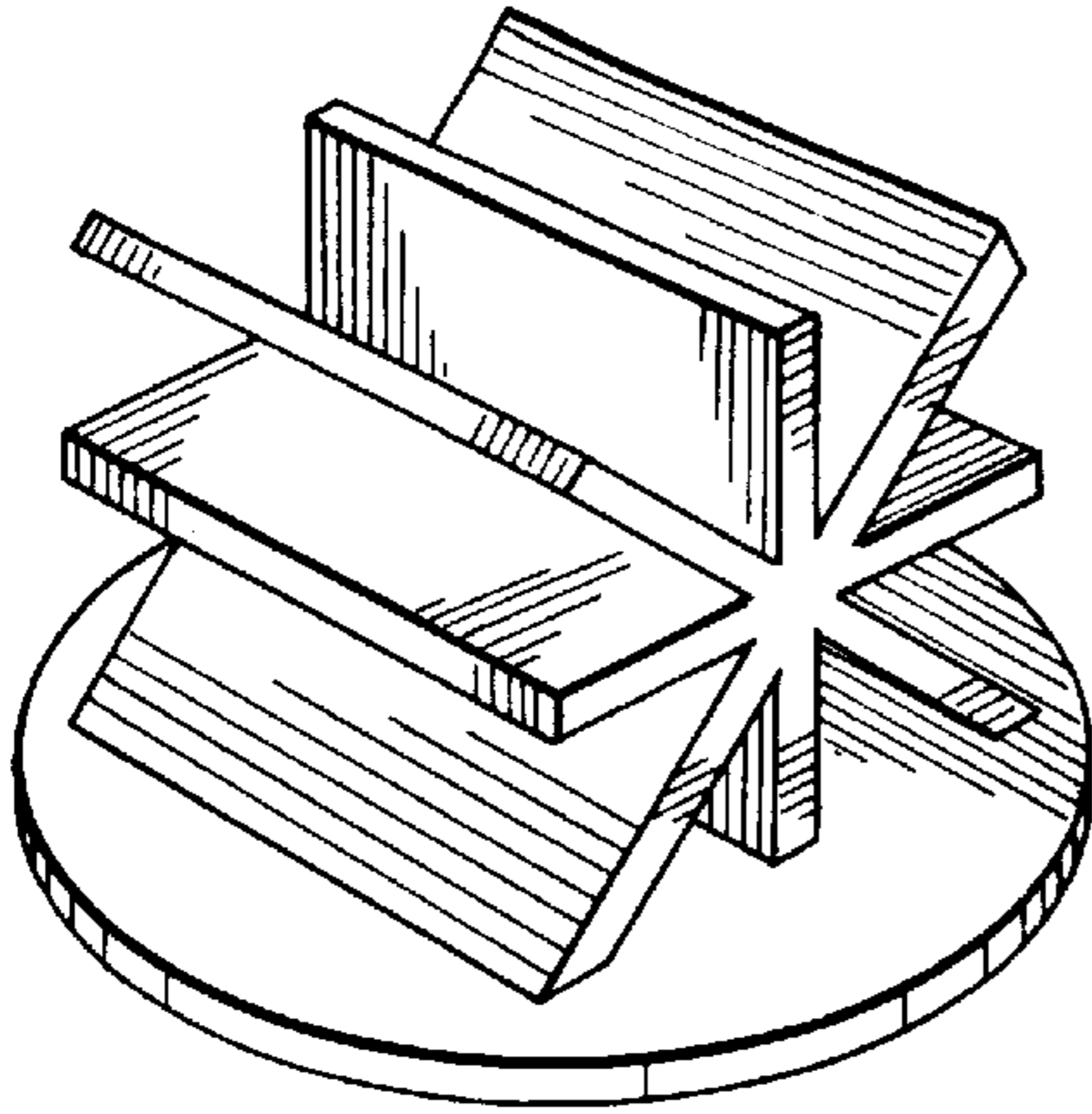

FIG 47

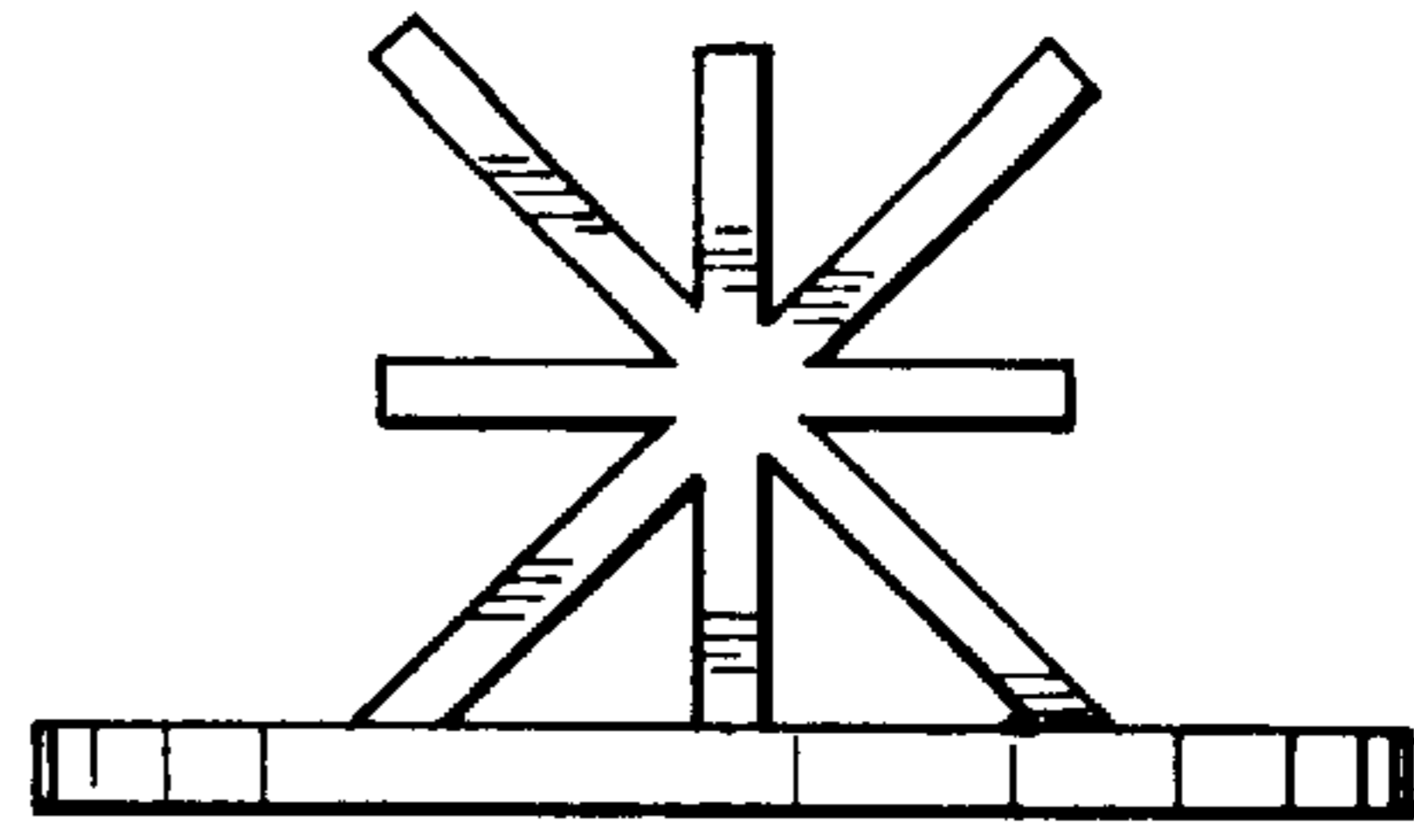

FIG. 48

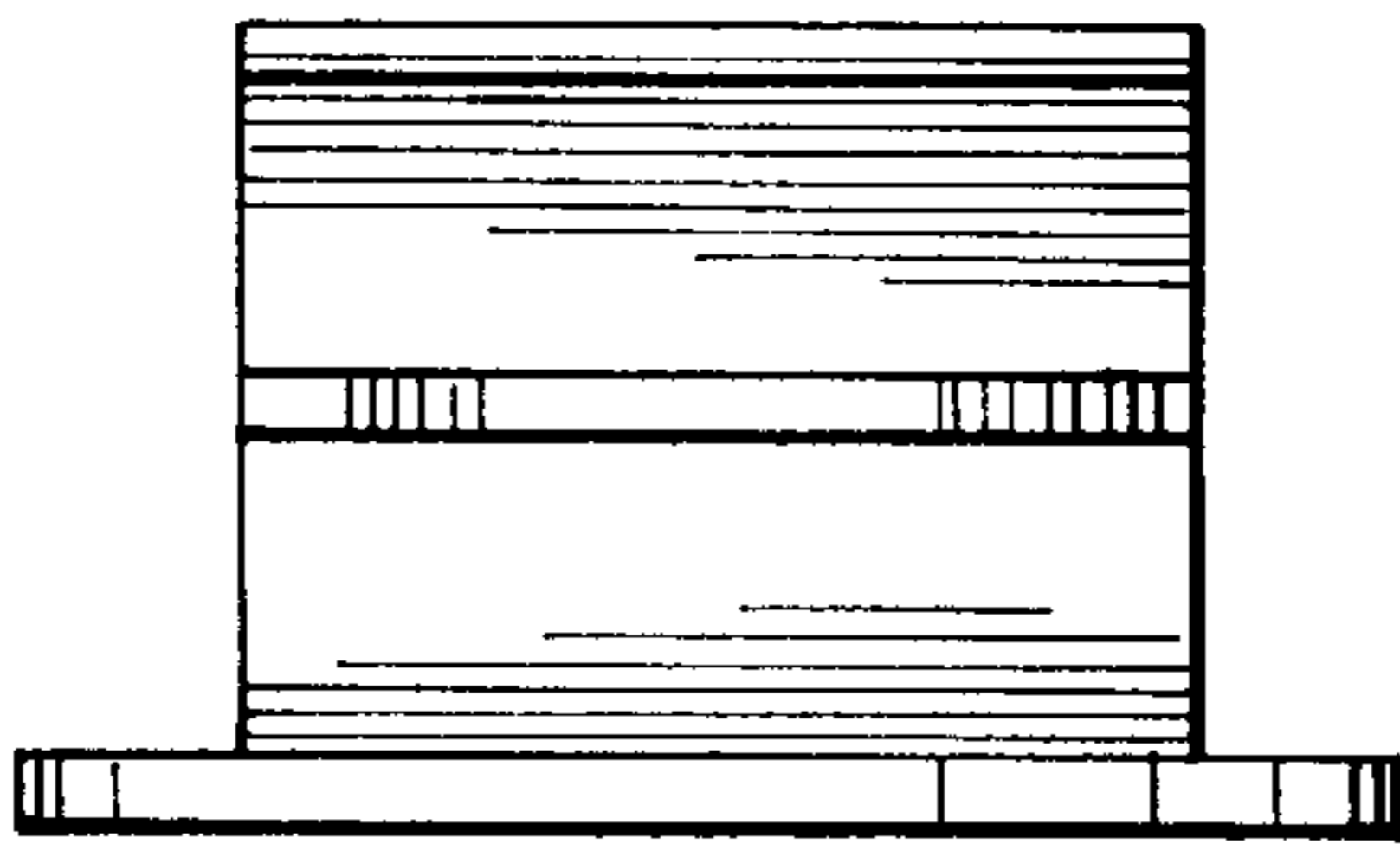

FIG. 49

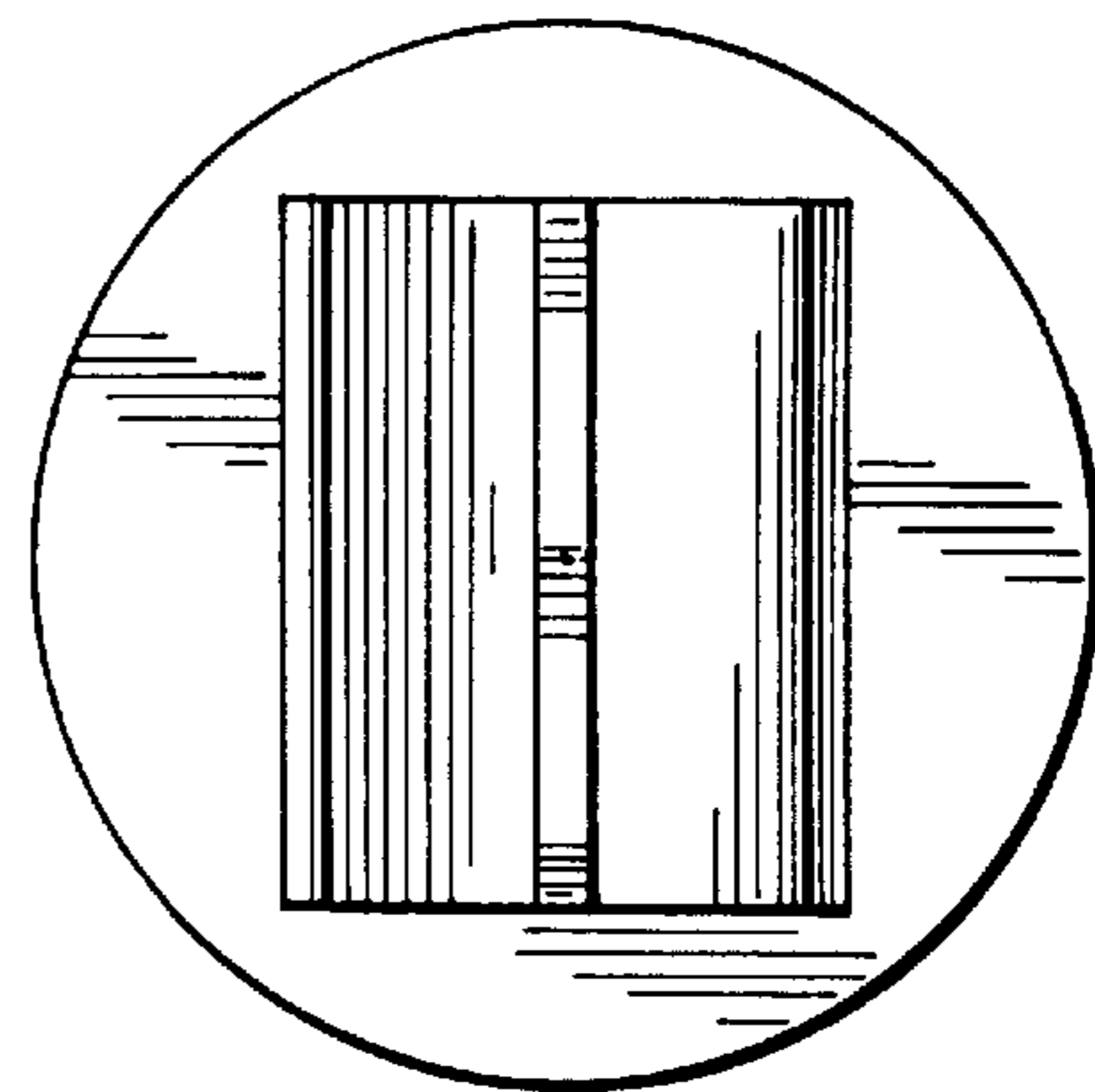

FIG. 50

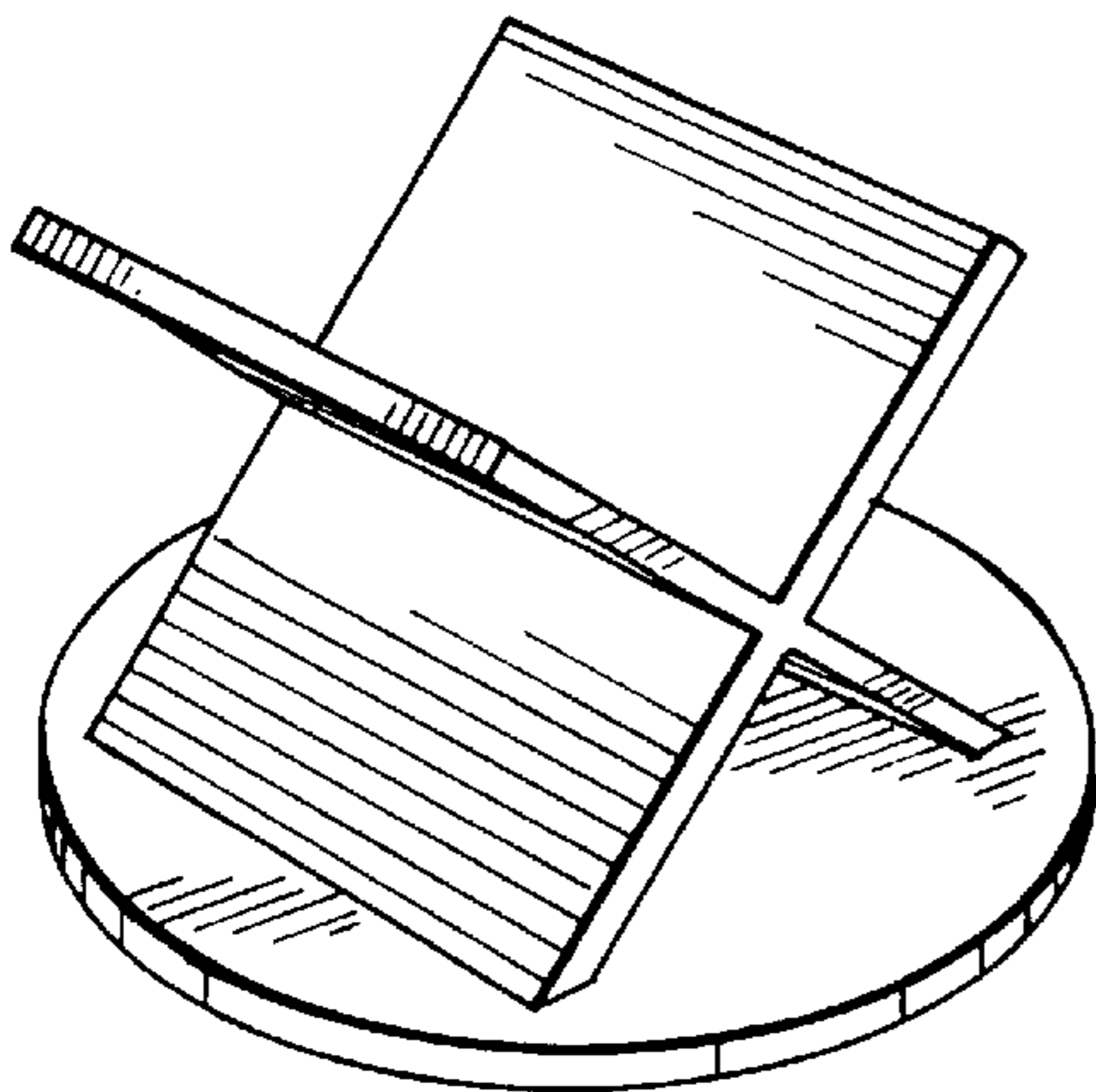

FIG. 51

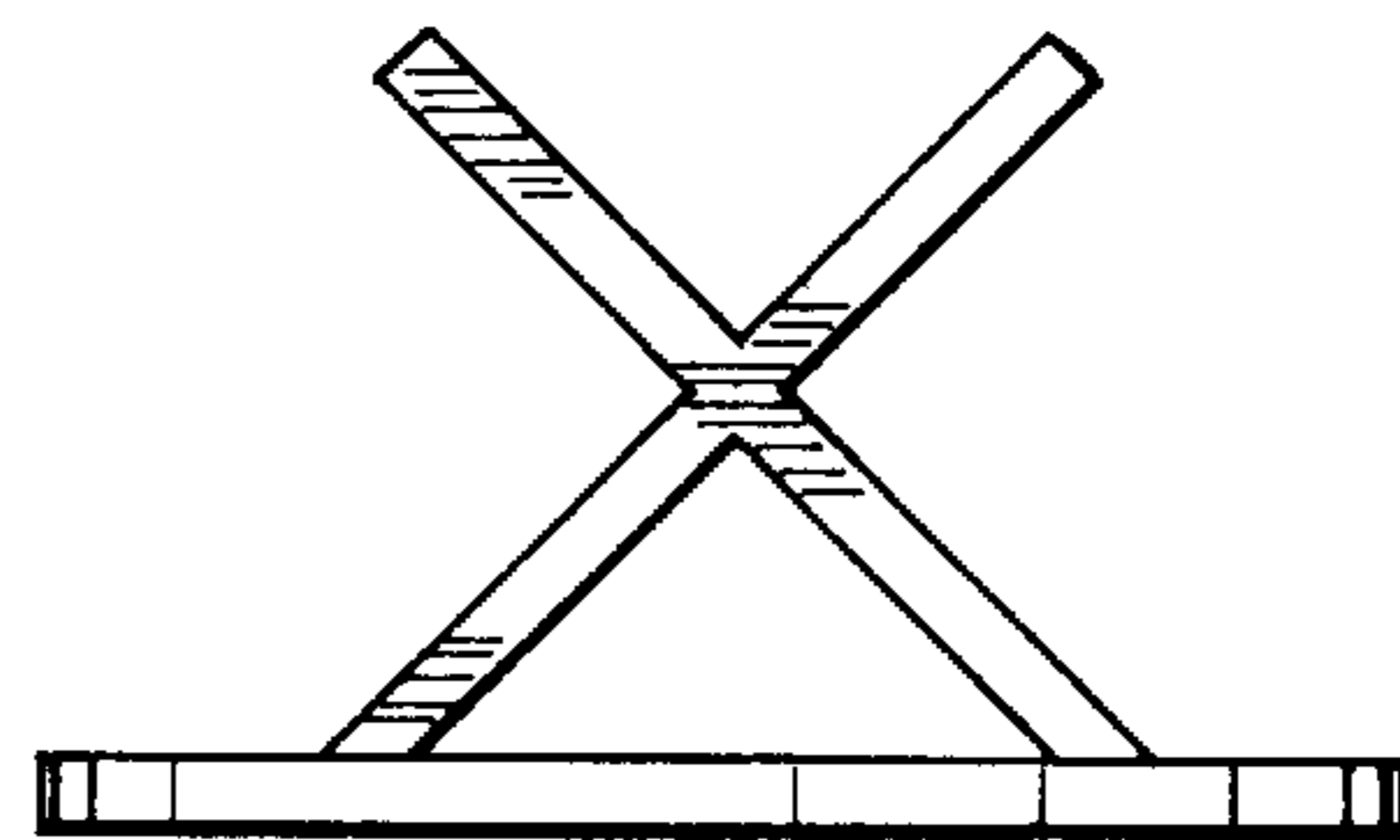

FIG. 52

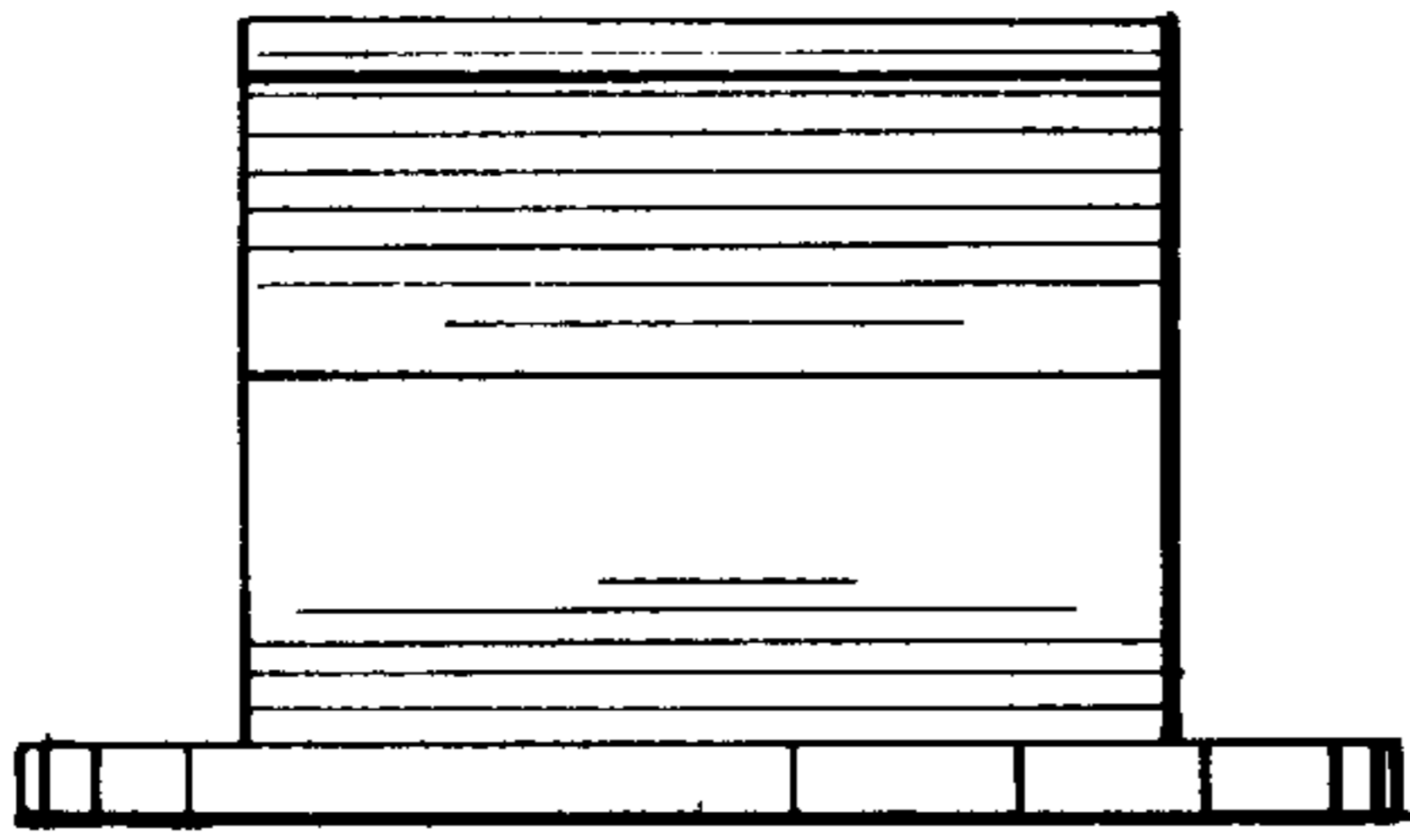

FIG. 53

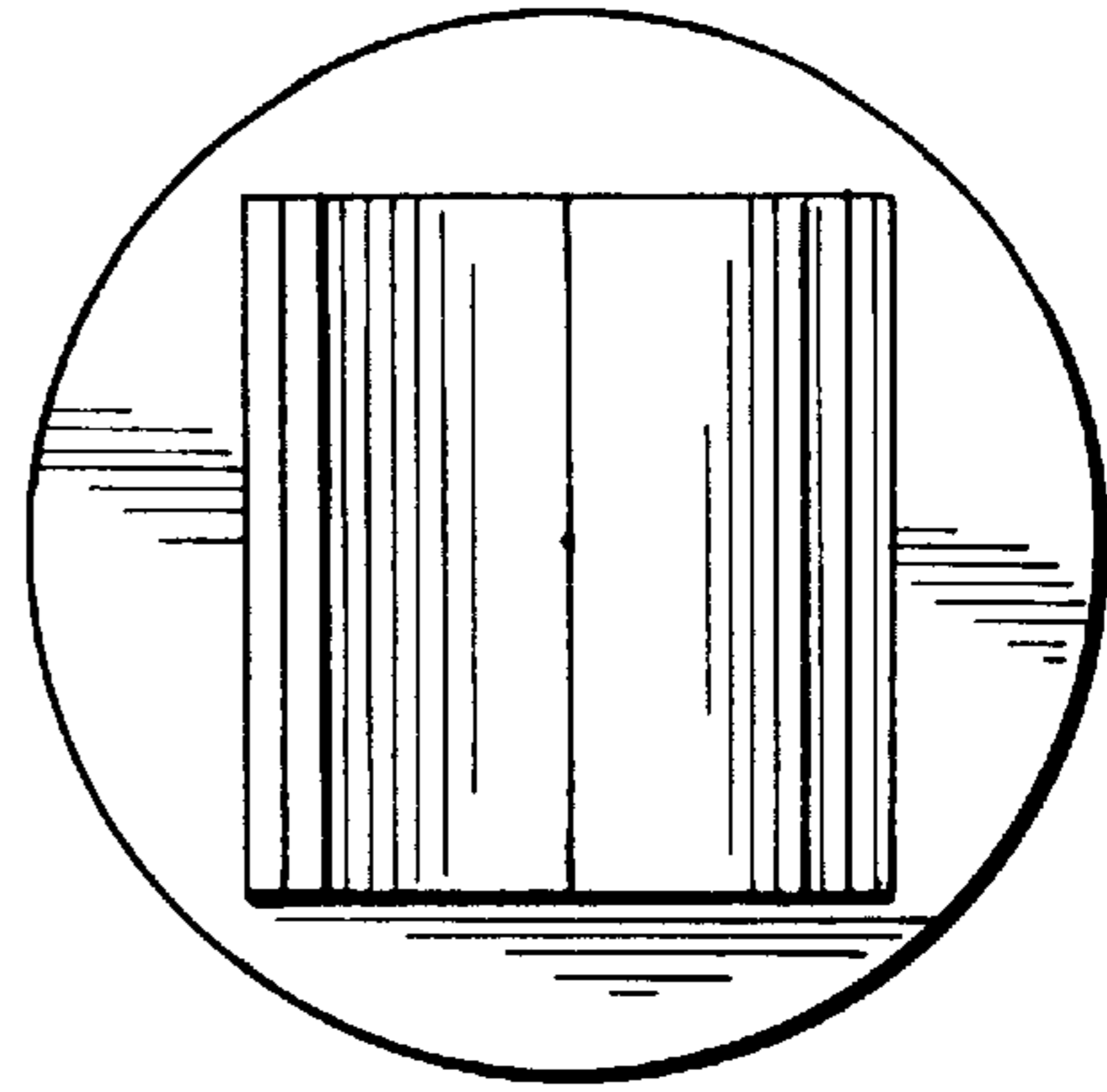

FIG. 54

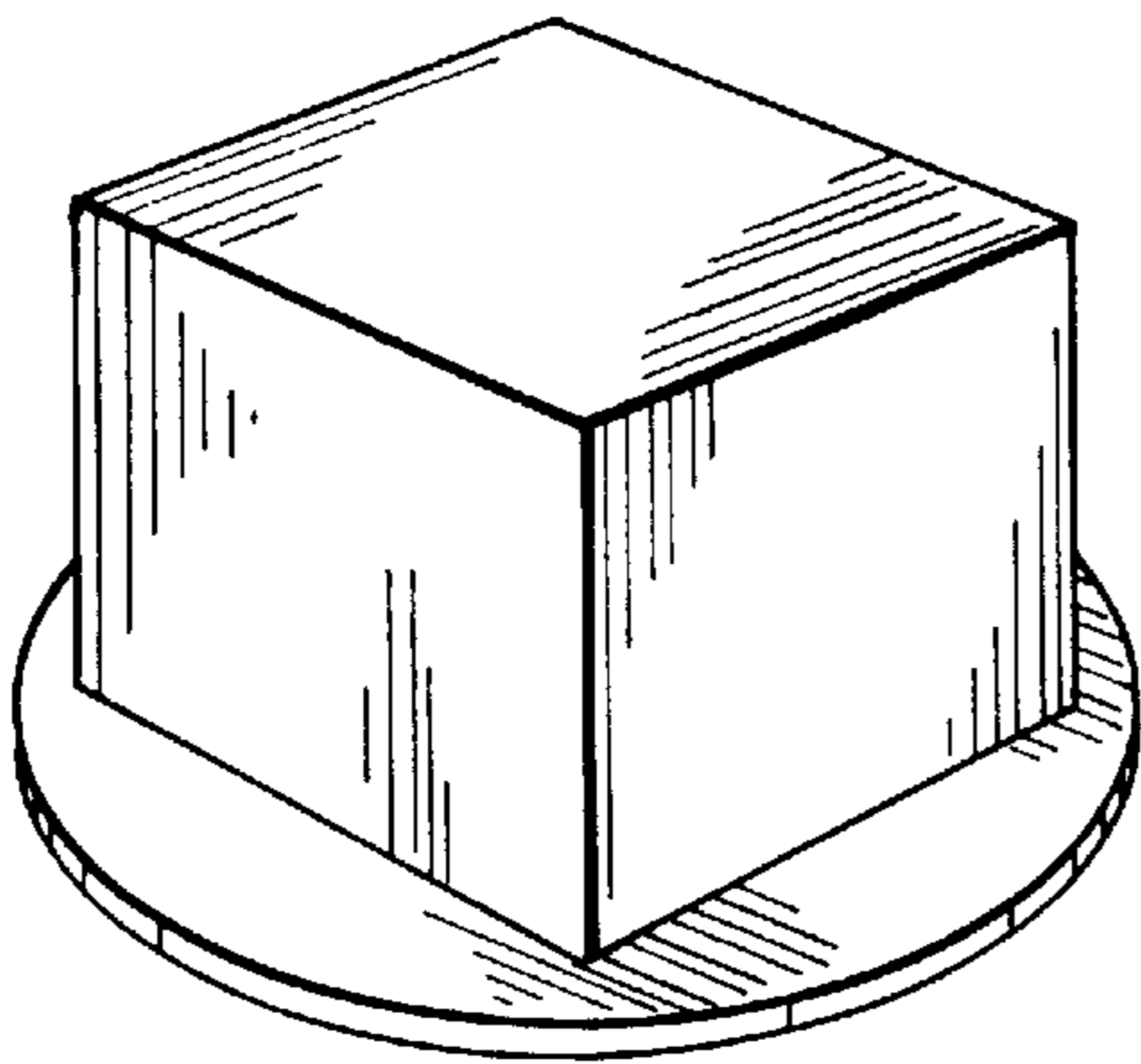

FIG. 55

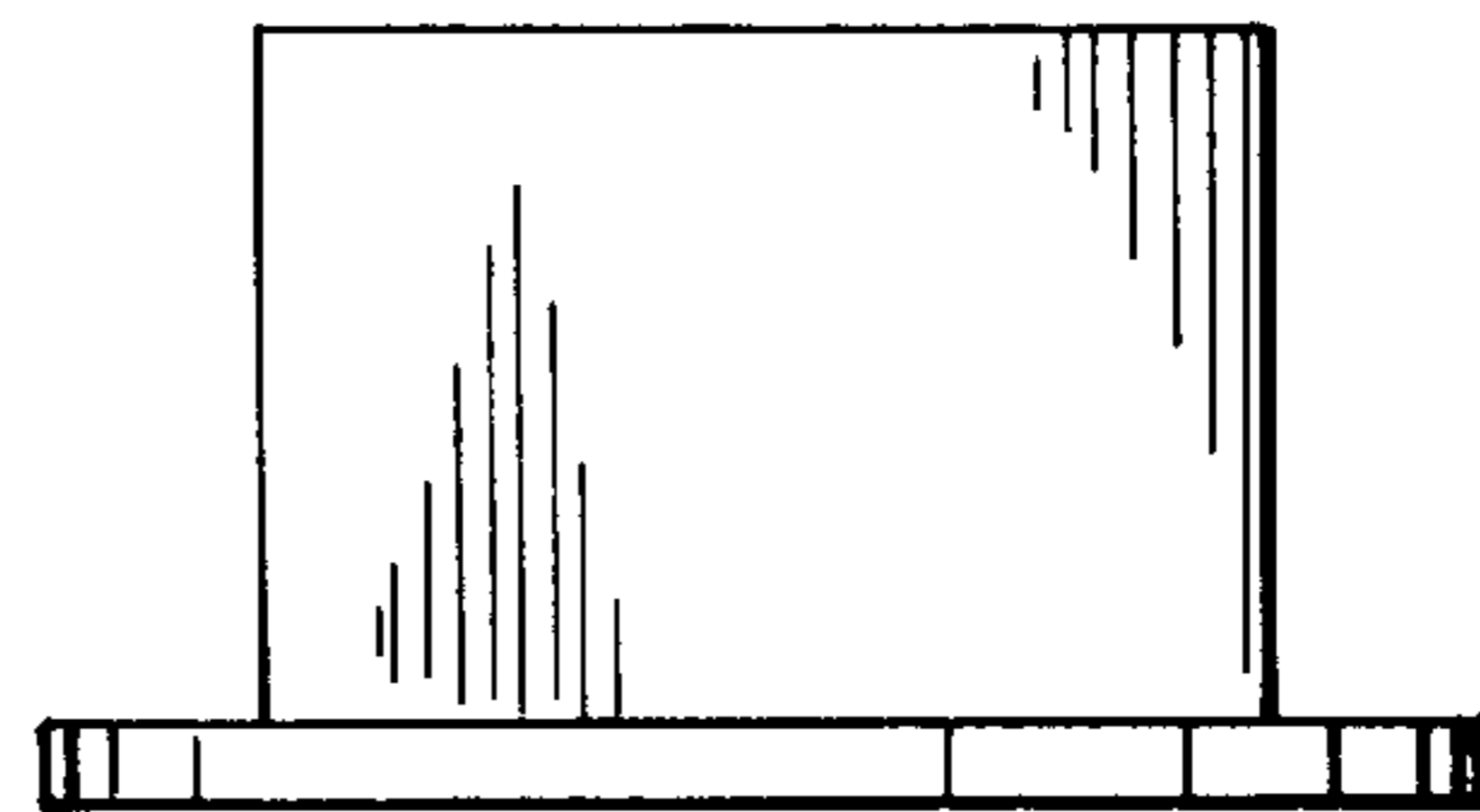

FIG. 56

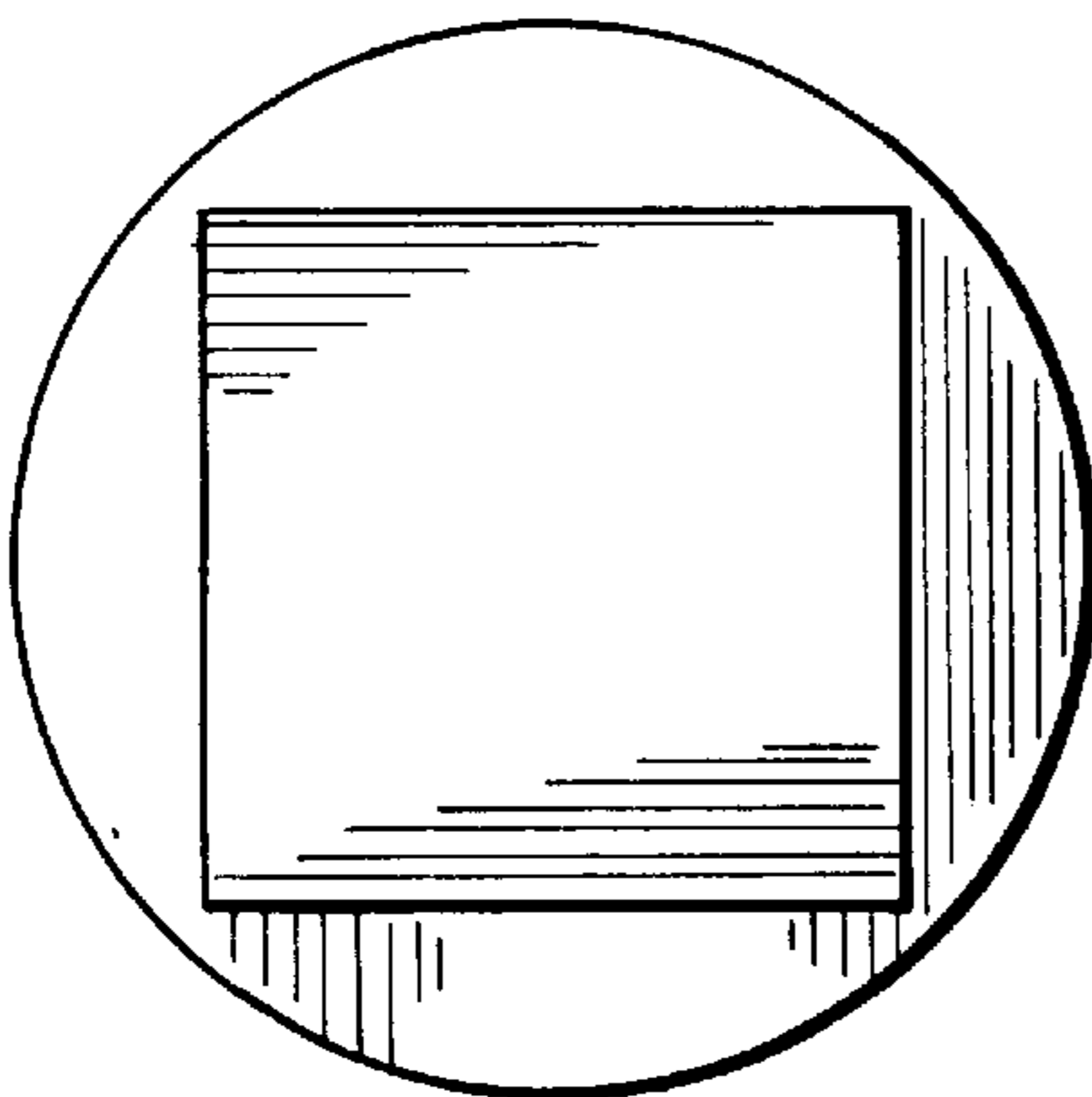

FIG. 57

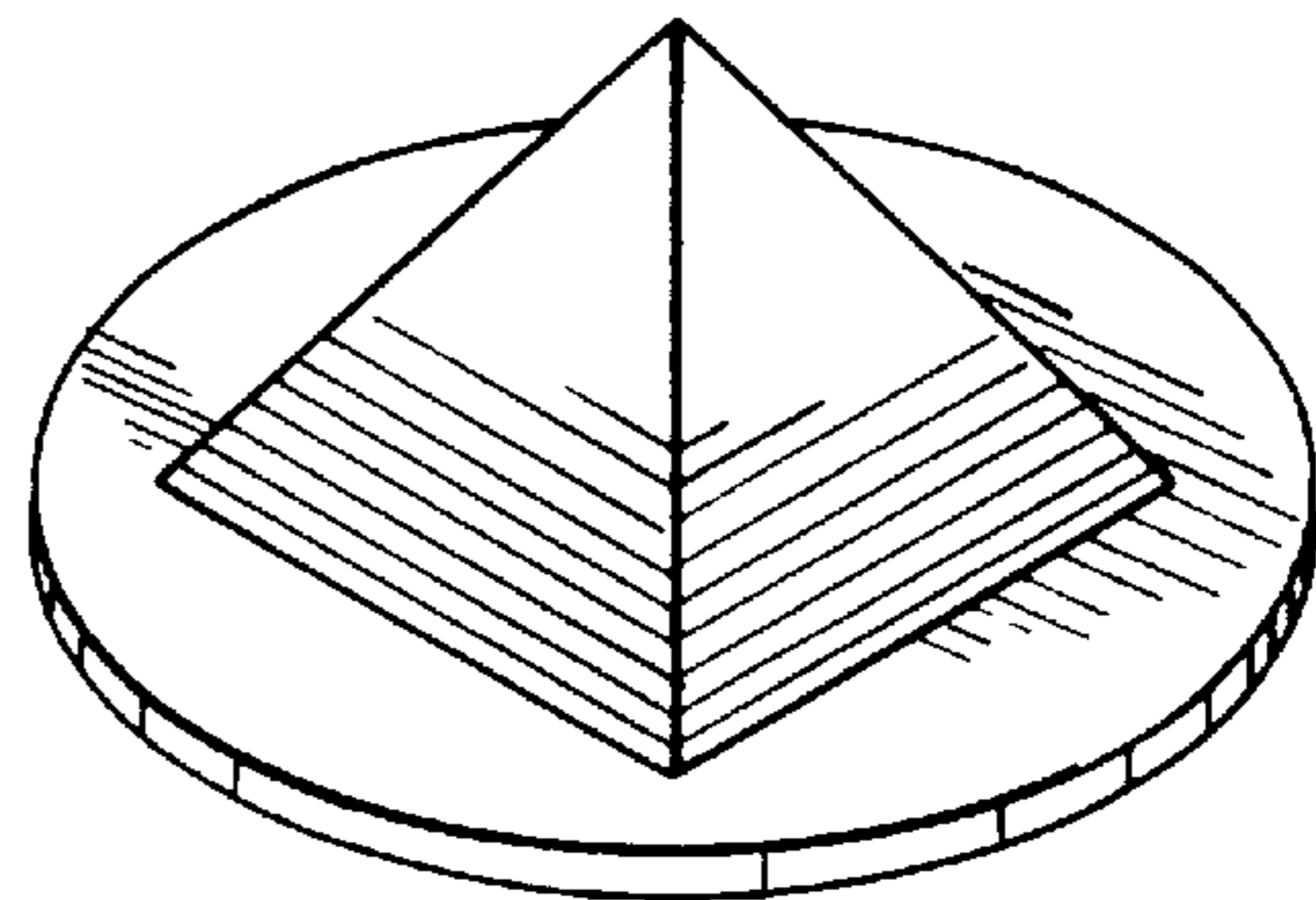

FIG. 58

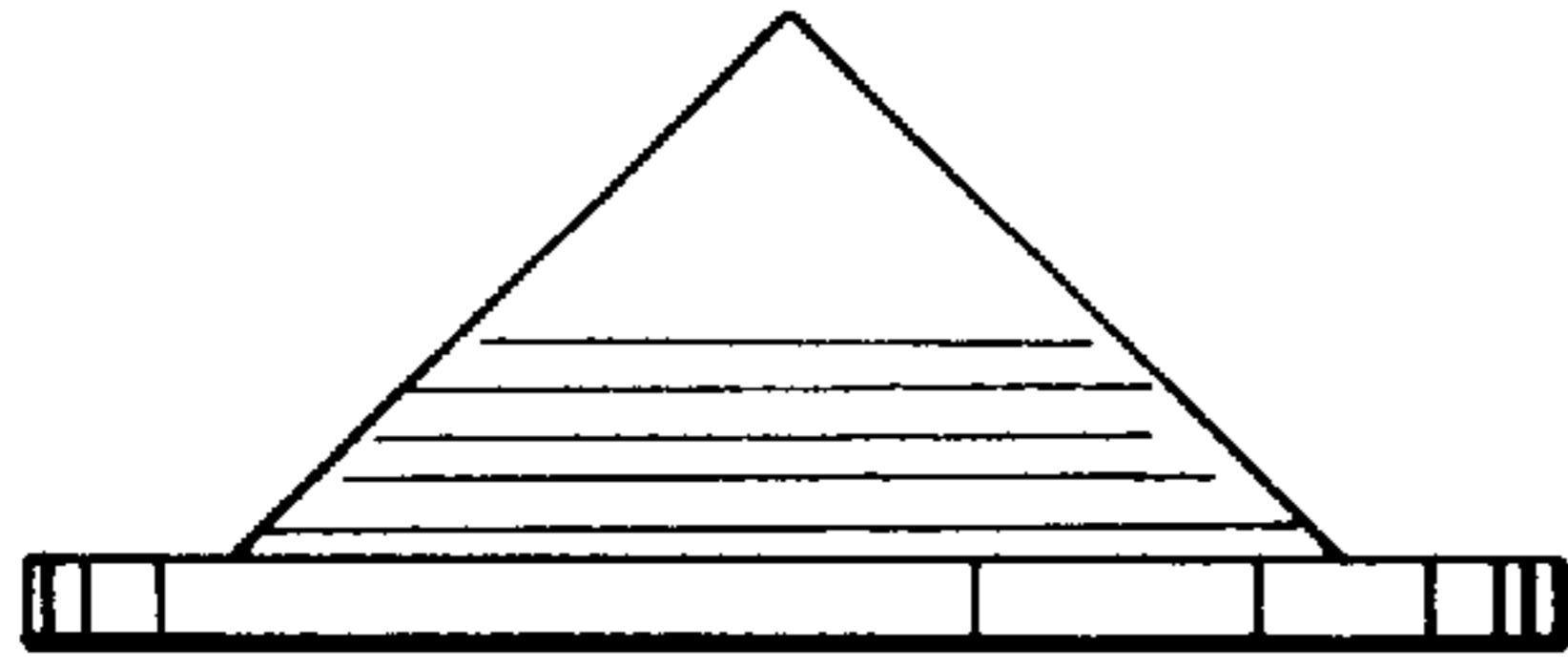

FIG. 59

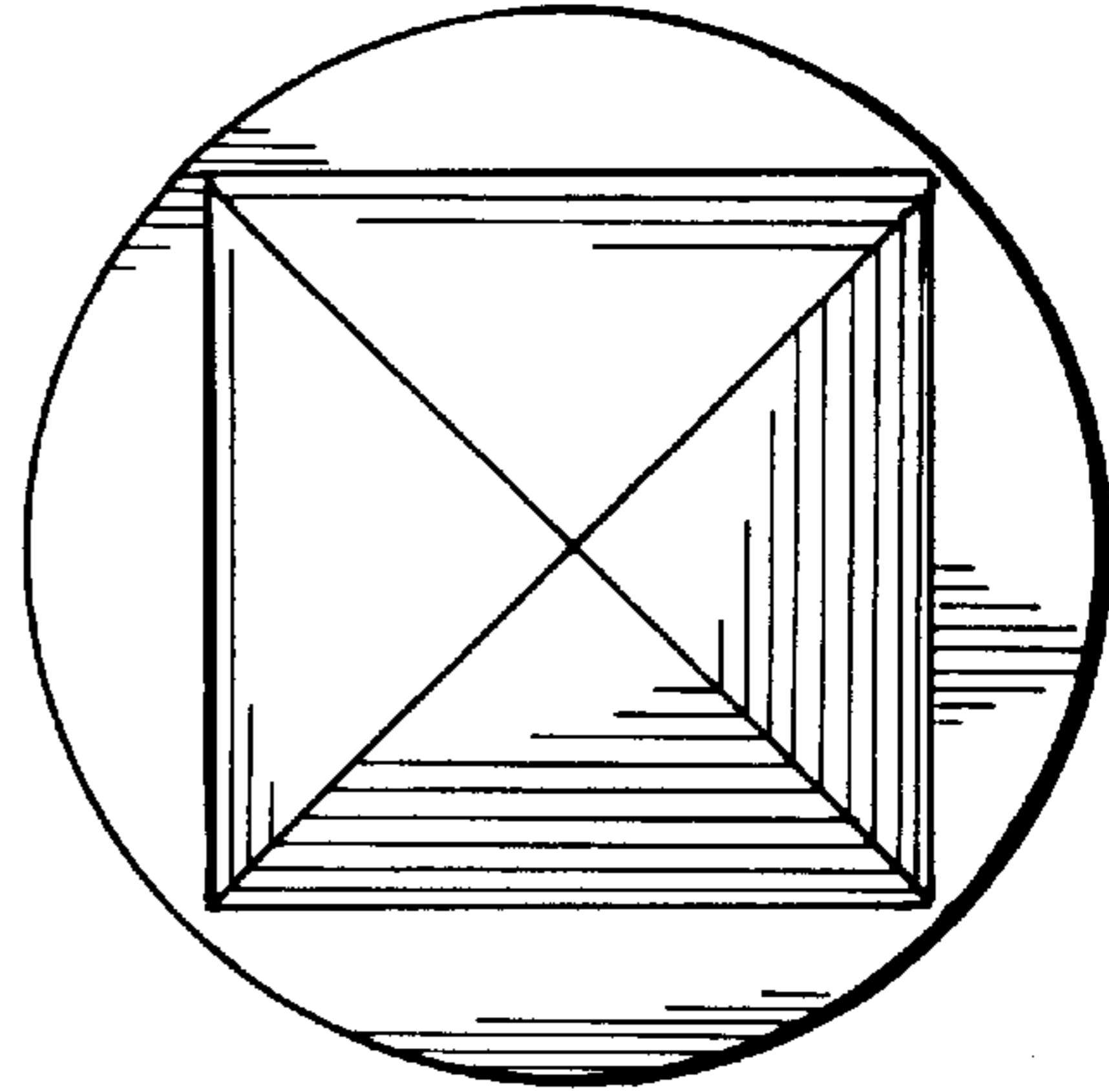

FIG. 60

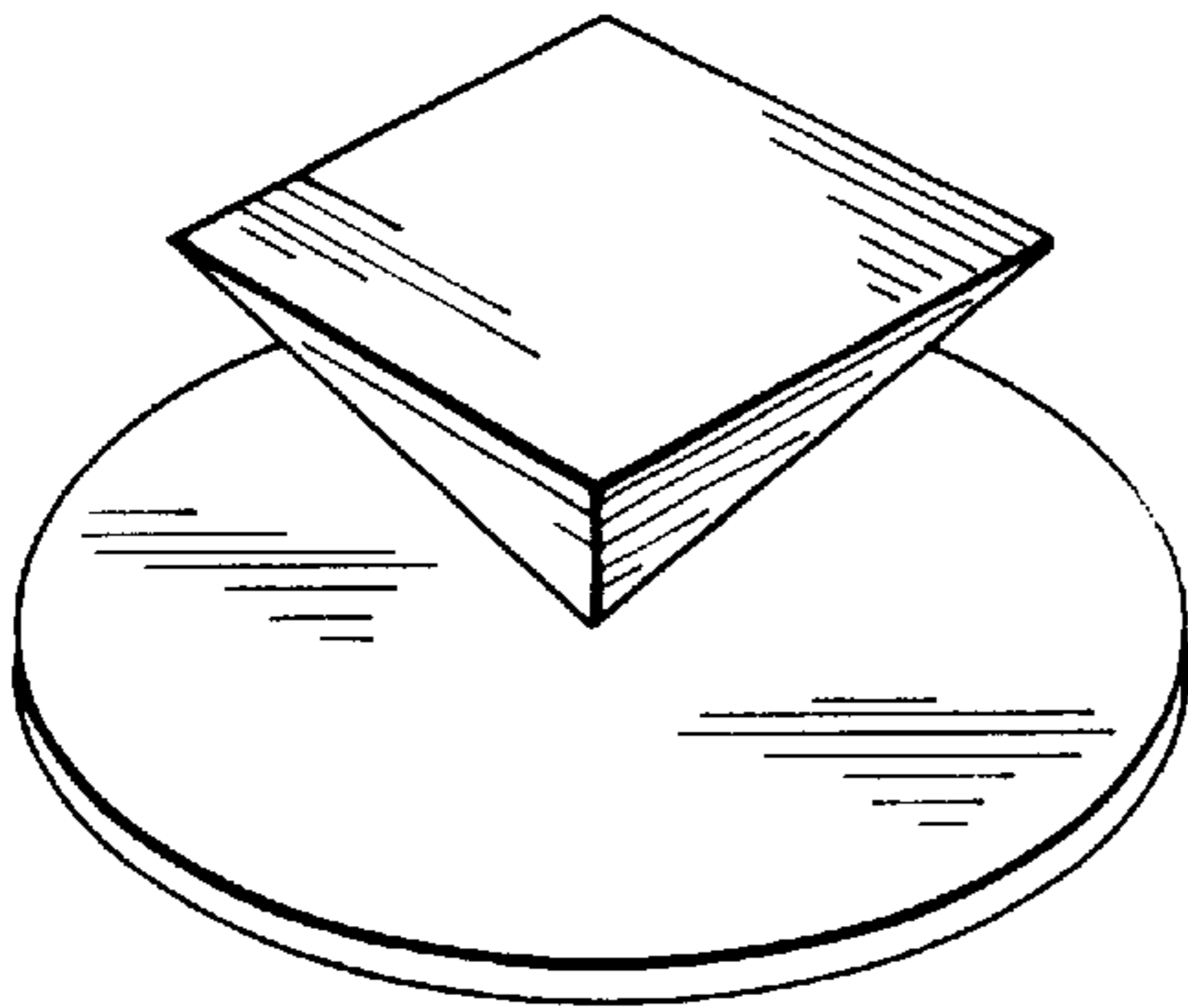

FIG. 62

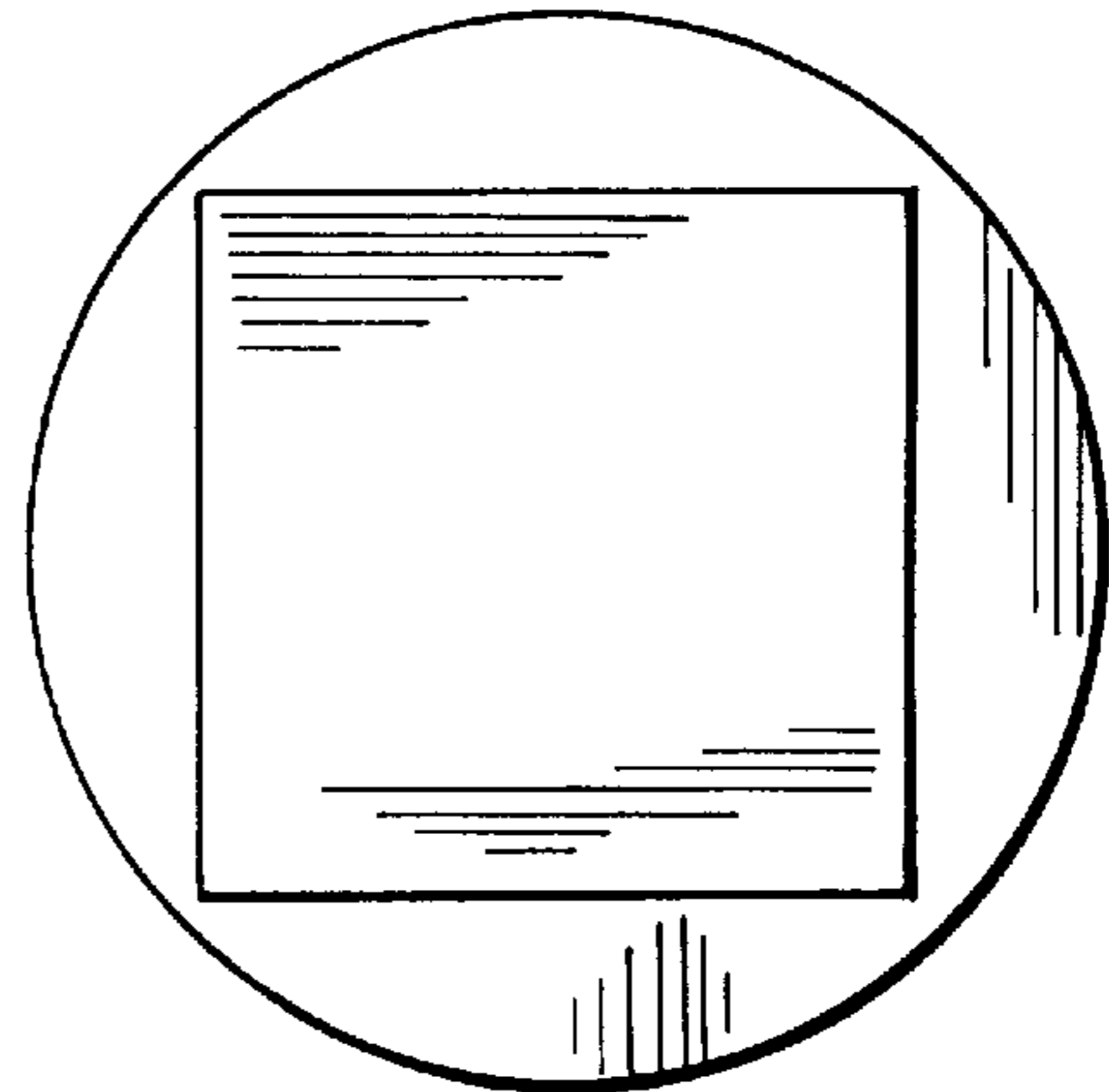

FIG. 61

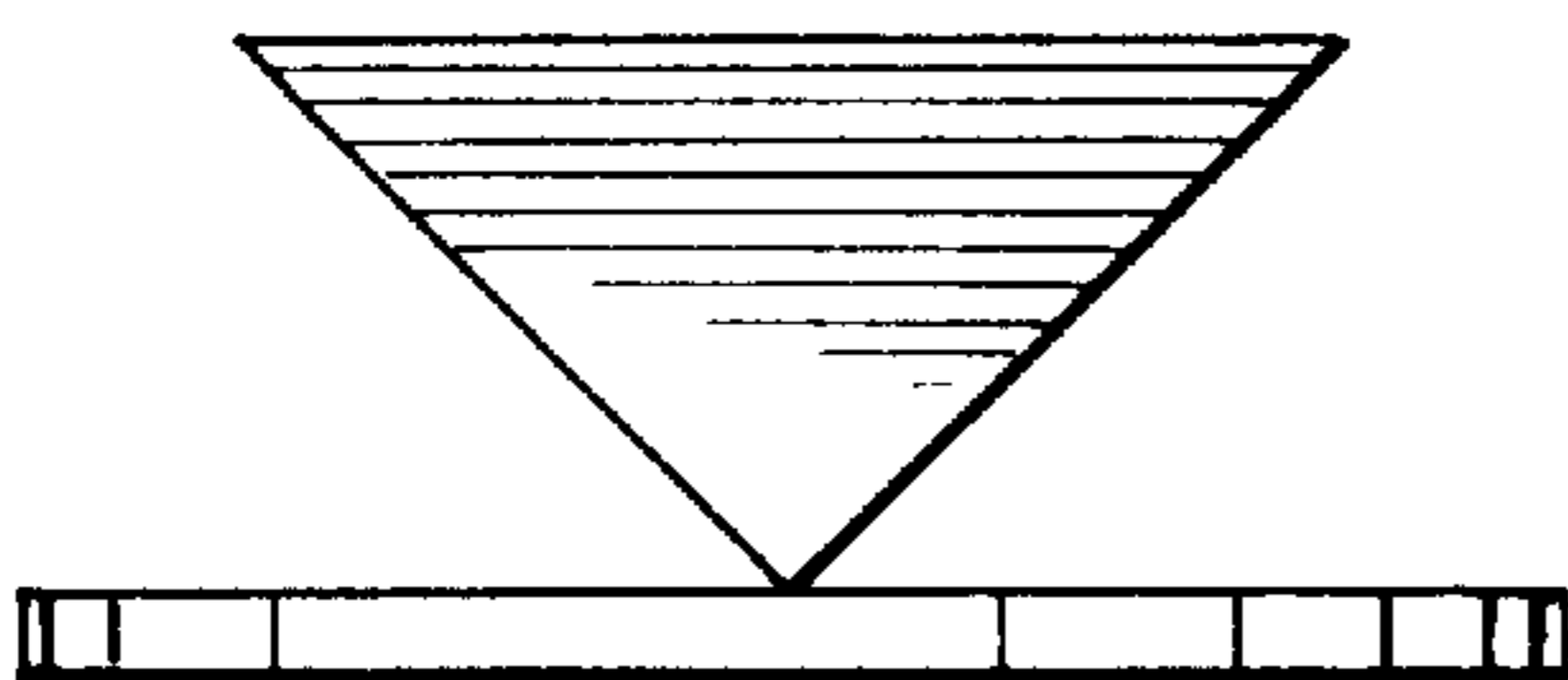

FIG. 63

