



US00D420295S

**United States Patent** [19]  
**Oshita**

[11] **Patent Number: Des. 420,295**

[45] **Date of Patent: \*\* Feb. 8, 2000**

[54] **WATCH CASE**

[75] **Inventor: Shinichiro Oshita, Kunitachi, Japan**

[73] **Assignee: Casio Keisanki Kabushiki Kaisha, Tokyo, Japan**

[\*\*] **Term: 14 Years**

[21] **Appl. No.: 29/098,070**

[22] **Filed: Dec. 21, 1998**

[51] **LOC (7) Cl. .... 10-02**

[52] **U.S. Cl. .... D10/30; D10/38**

[58] **Field of Search** ..... D10/1-40, 122-132;  
368/280-282, 276-277, 28-30, 285, 239-242,  
82-84, 41, 44

[56] **References Cited**

**U.S. PATENT DOCUMENTS**

D. 378,198	2/1997	Tomita et al. ....	D10/38
D. 378,574	3/1997	Houlihan .....	D10/30
D. 394,401	5/1998	Moriai et al. ....	D10/30
D. 401,160	11/1998	Akagi .....	D10/30
D. 402,898	12/1998	Hanagata .....	D10/30

*Primary Examiner*—Nelson C. Holtje  
*Attorney, Agent, or Firm*—Frishauf, Holtz, Goodman,  
Langer & Chick, P.C.

[57] **CLAIM**

The ornamental design for watch case, as shown.

**DESCRIPTION**

FIG. 1 is a front elevational view of watch case showing my new design;  
FIG. 2 is a right side elevational view thereof;  
FIG. 3 is a left side elevational view thereof;  
FIG. 4 is a top plan view thereof;  
FIG. 5 is a bottom plan view thereof;  
FIG. 6 is a rear elevational view thereof;  
FIG. 7 is a perspective view thereof;  
FIG. 8 is a front elevational view of a second embodiment of my new design of FIGS. 1-7;  
FIG. 9 is a right side elevational view thereof;  
FIG. 10 is a left side elevational view thereof;  
FIG. 11 is a top plan view thereof;  
FIG. 12 is a bottom plan view thereof;  
FIG. 13 is a rear elevational view thereof; and,  
FIG. 14 is a perspective view thereof.

**1 Claim, 4 Drawing Sheets**

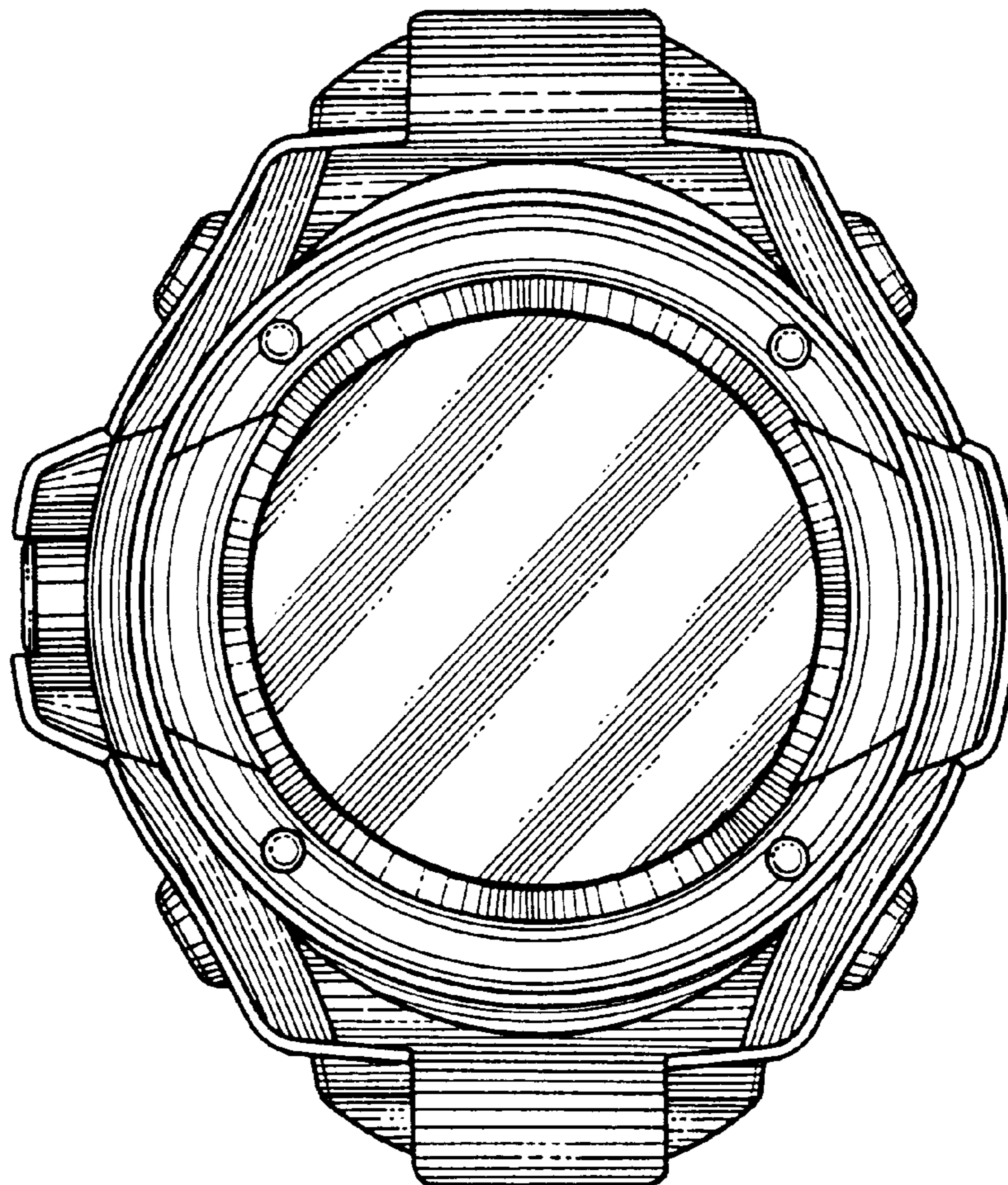

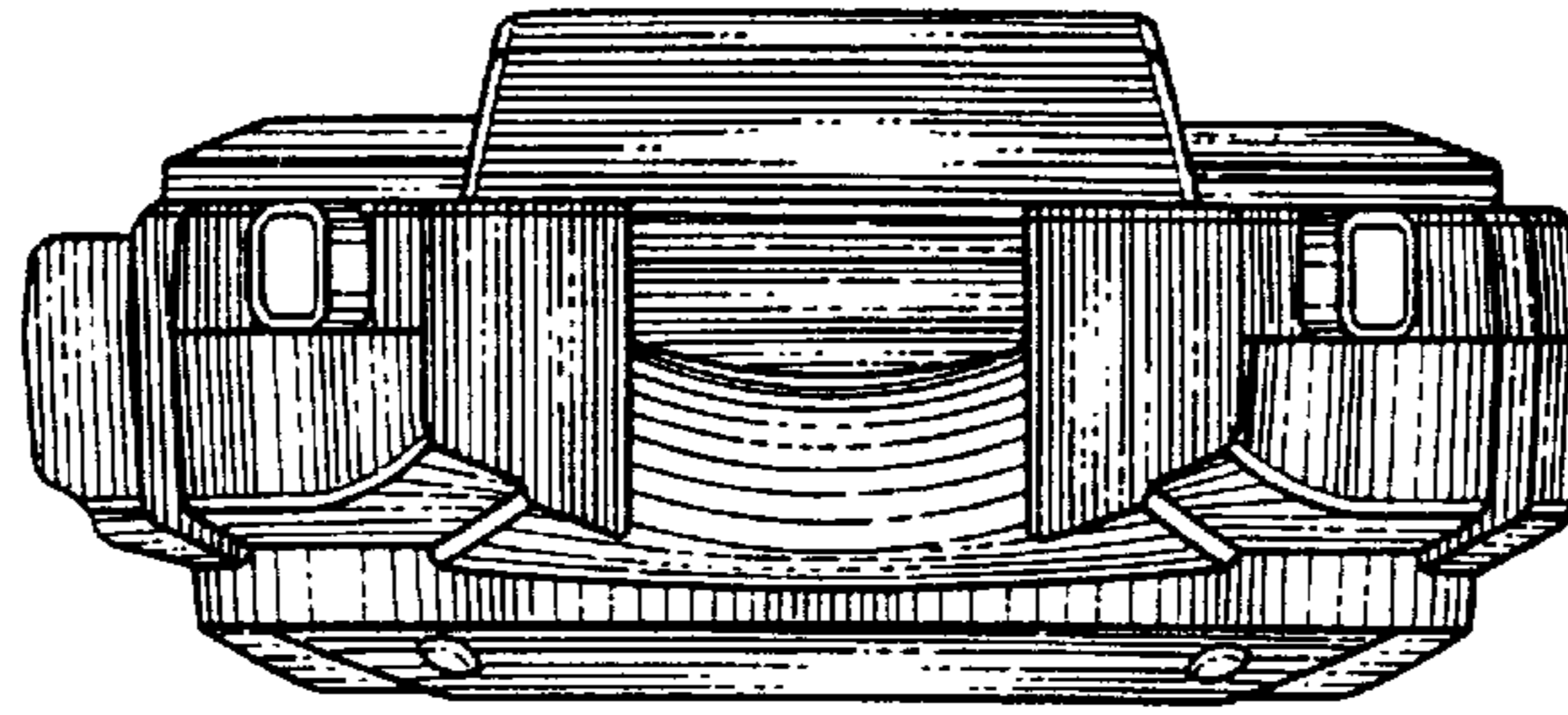

FIG. 4

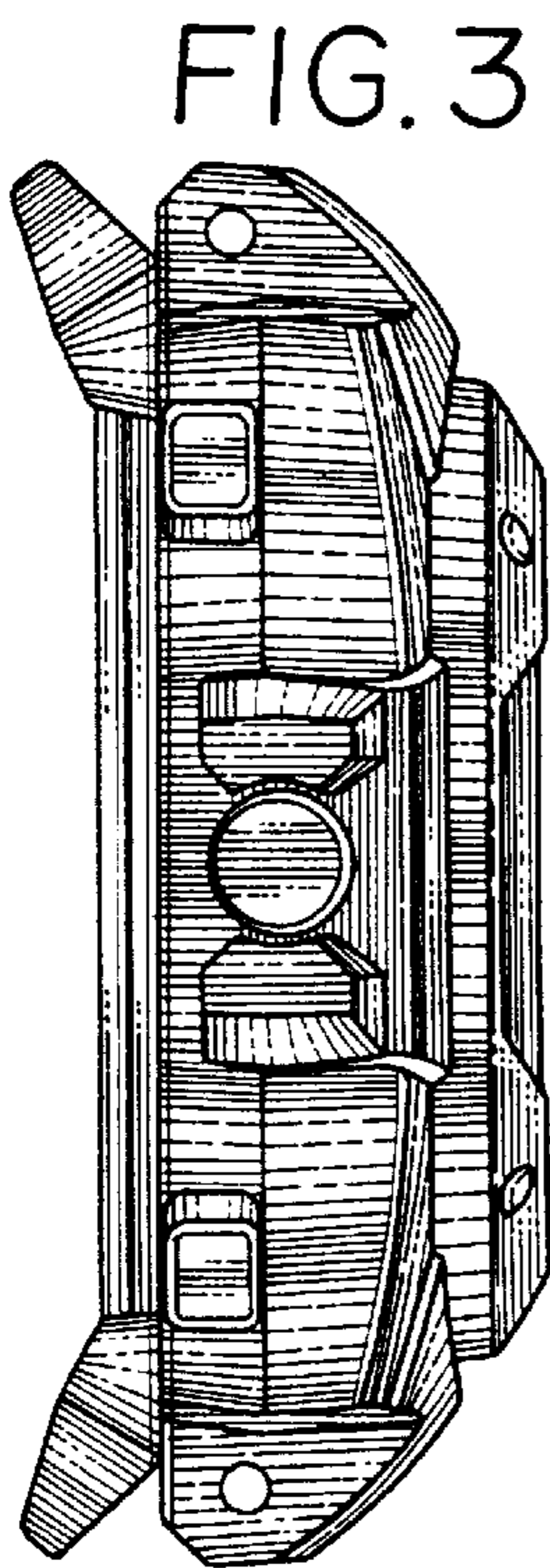

FIG. 3

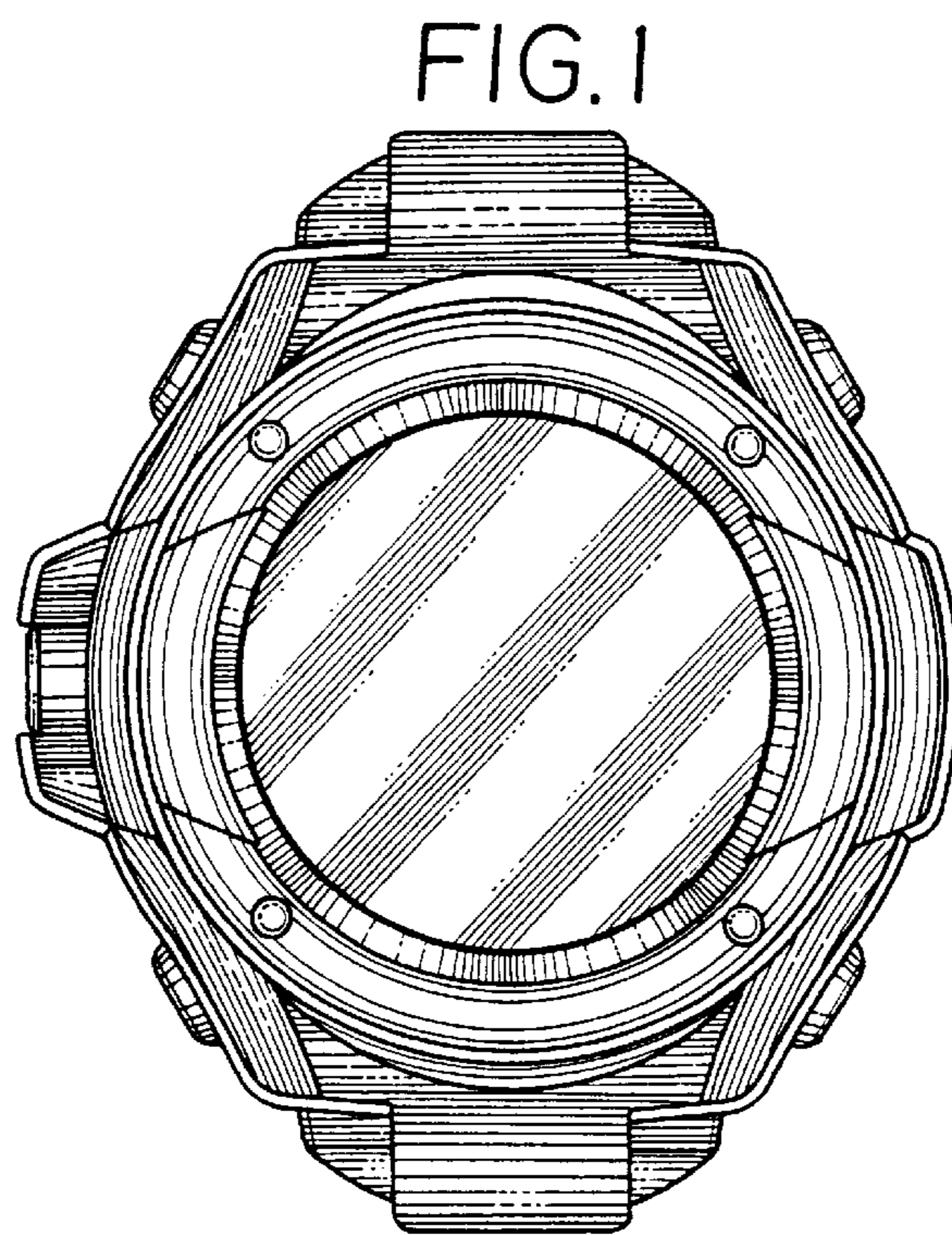

FIG. 1

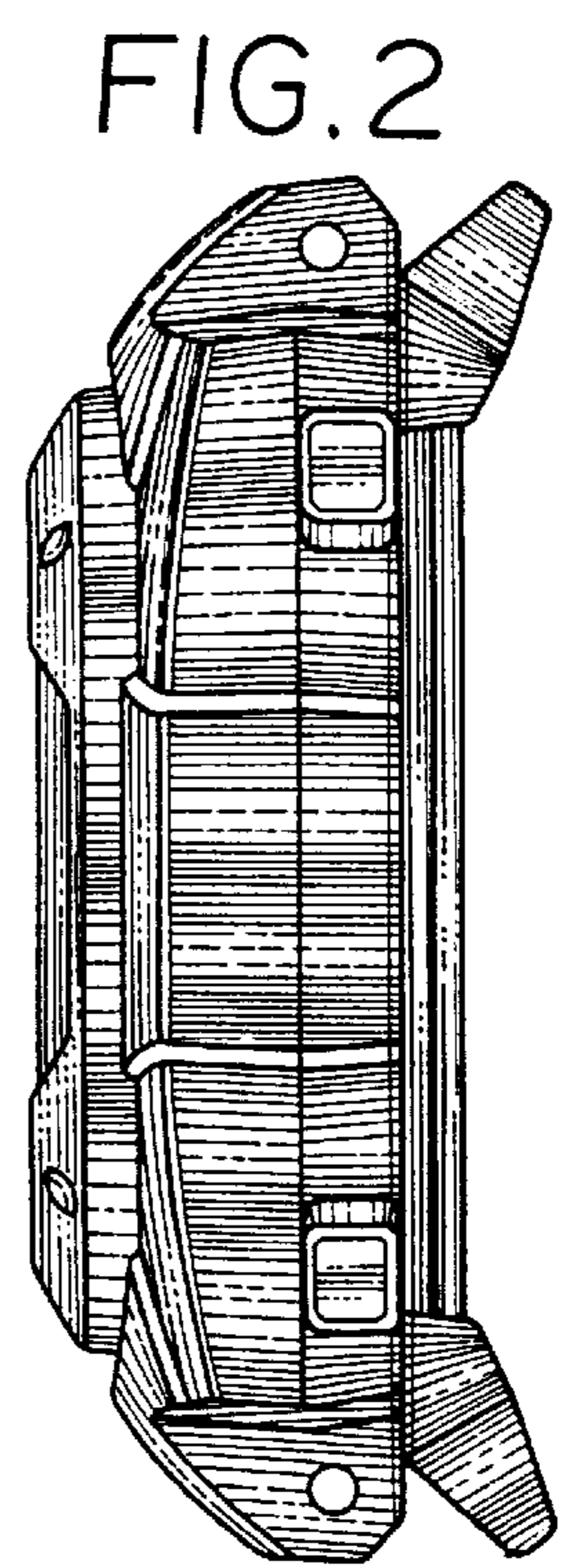

FIG. 2

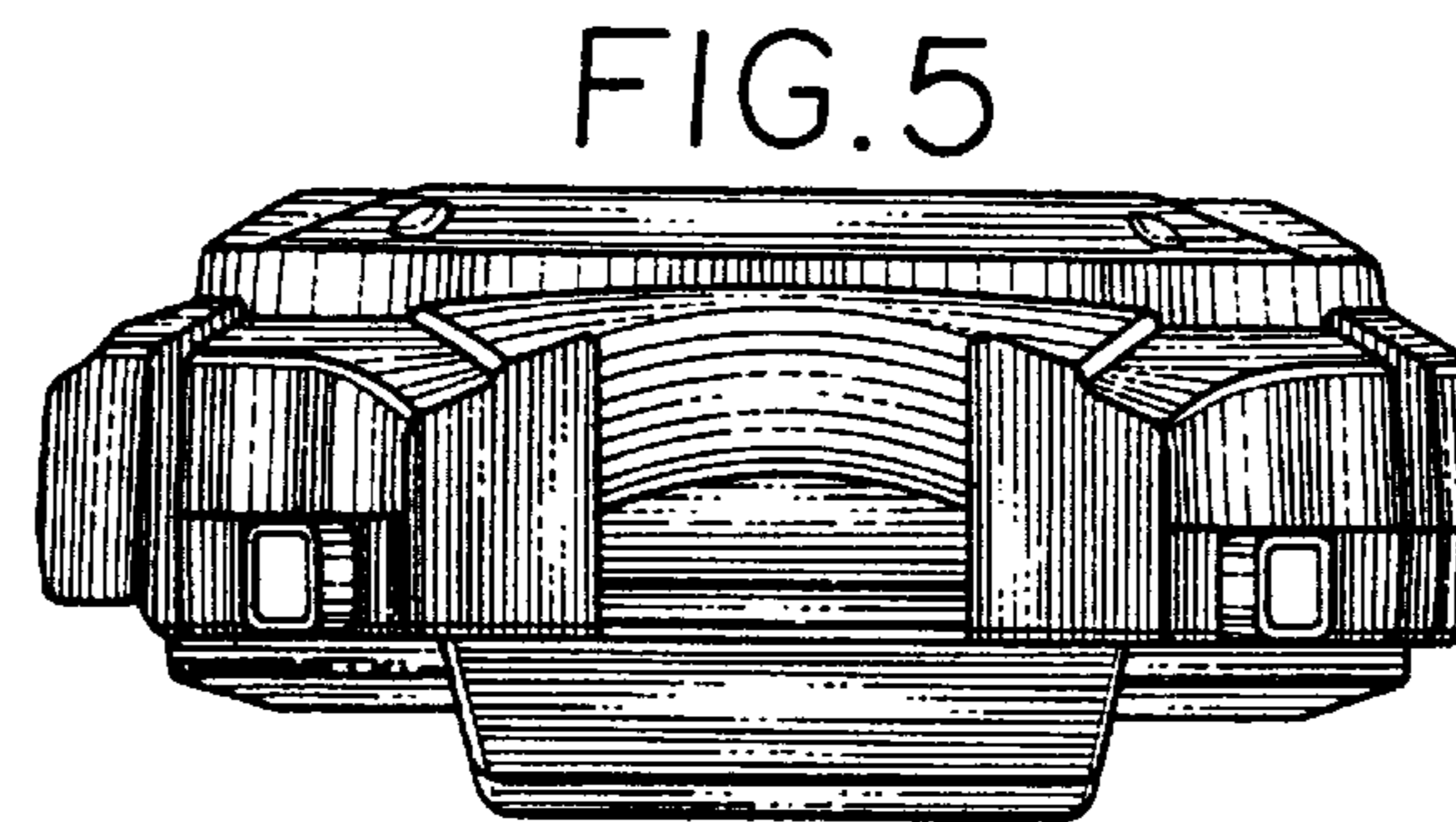

FIG. 5

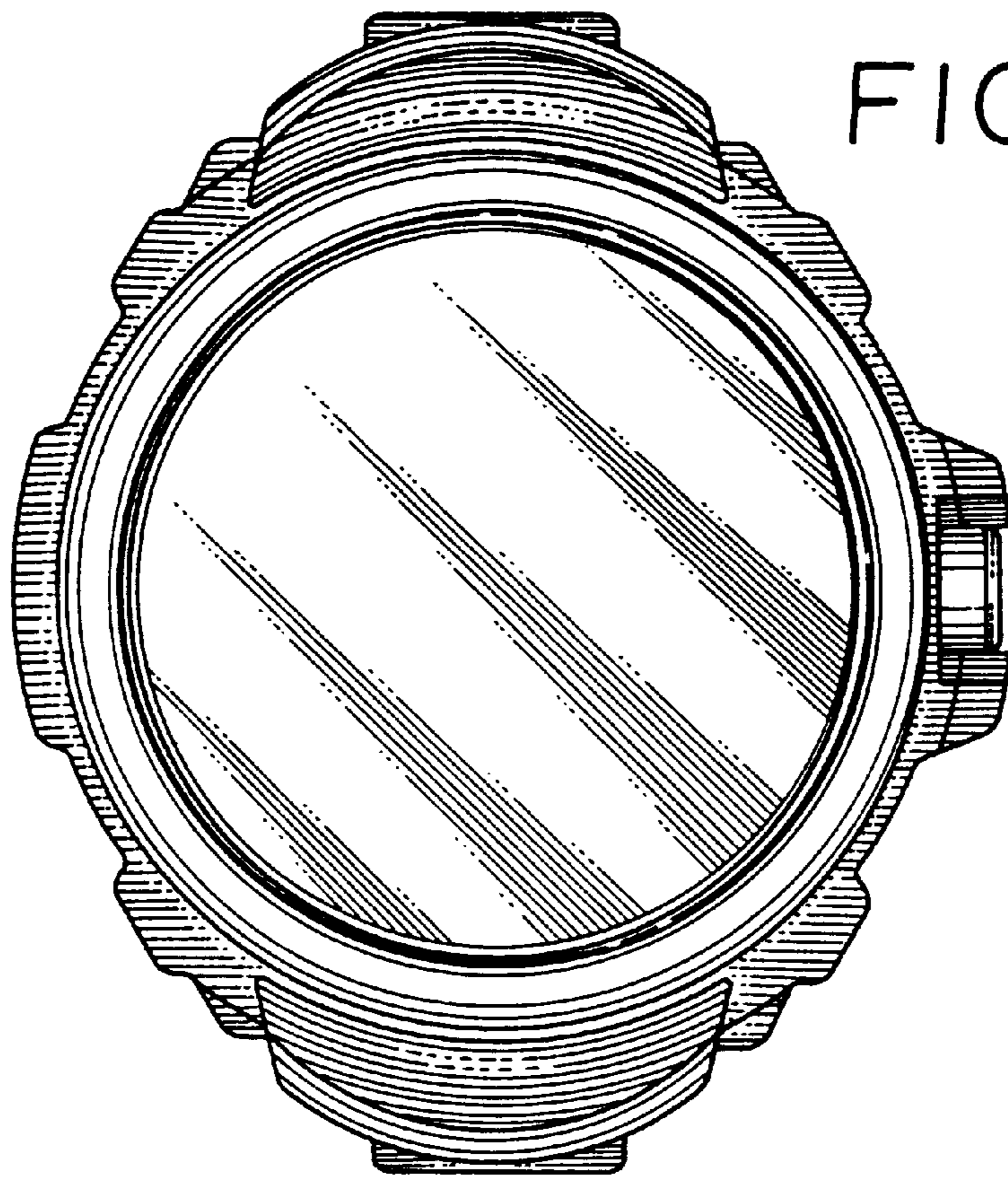
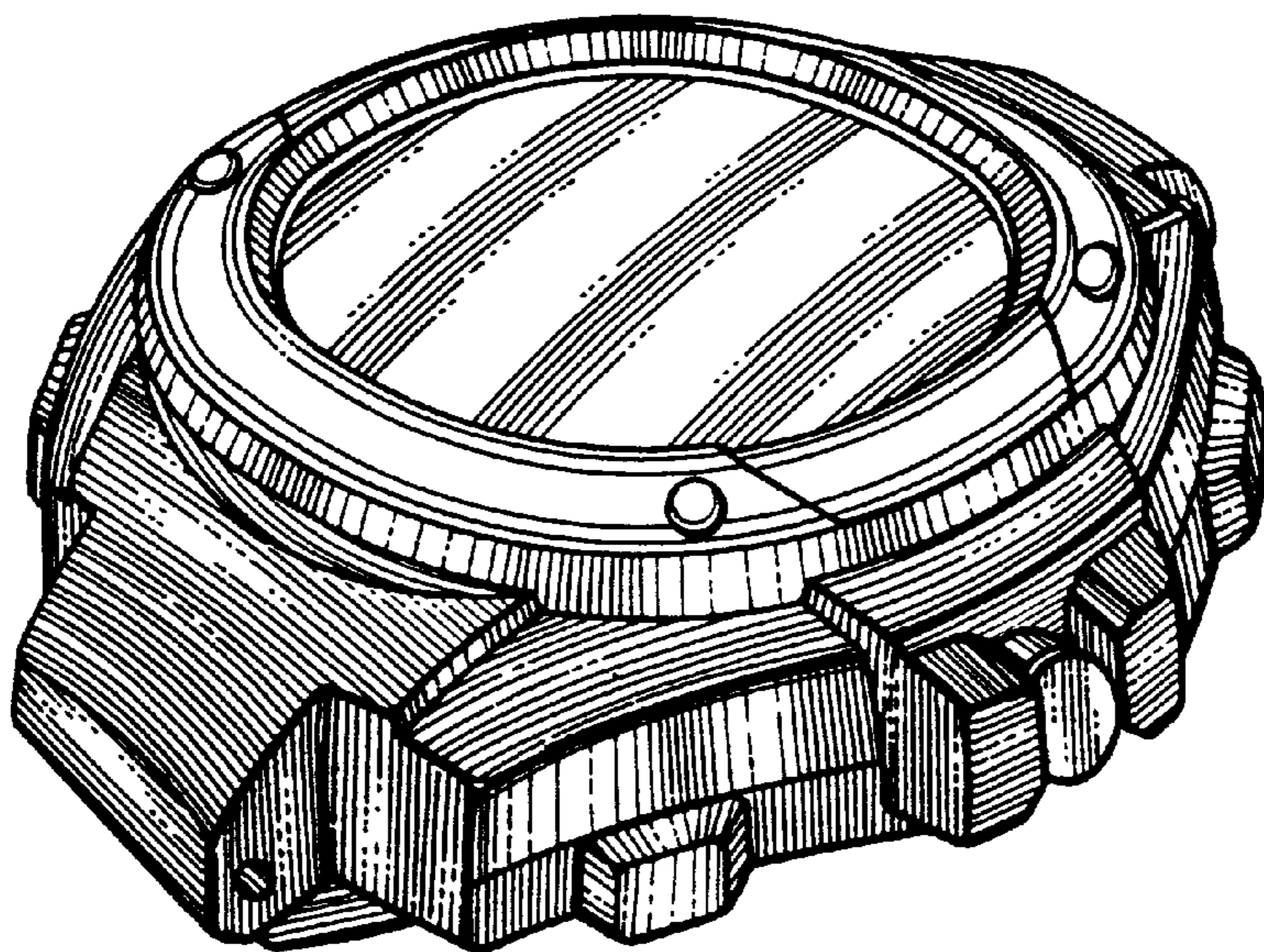

FIG. 6

FIG. 7



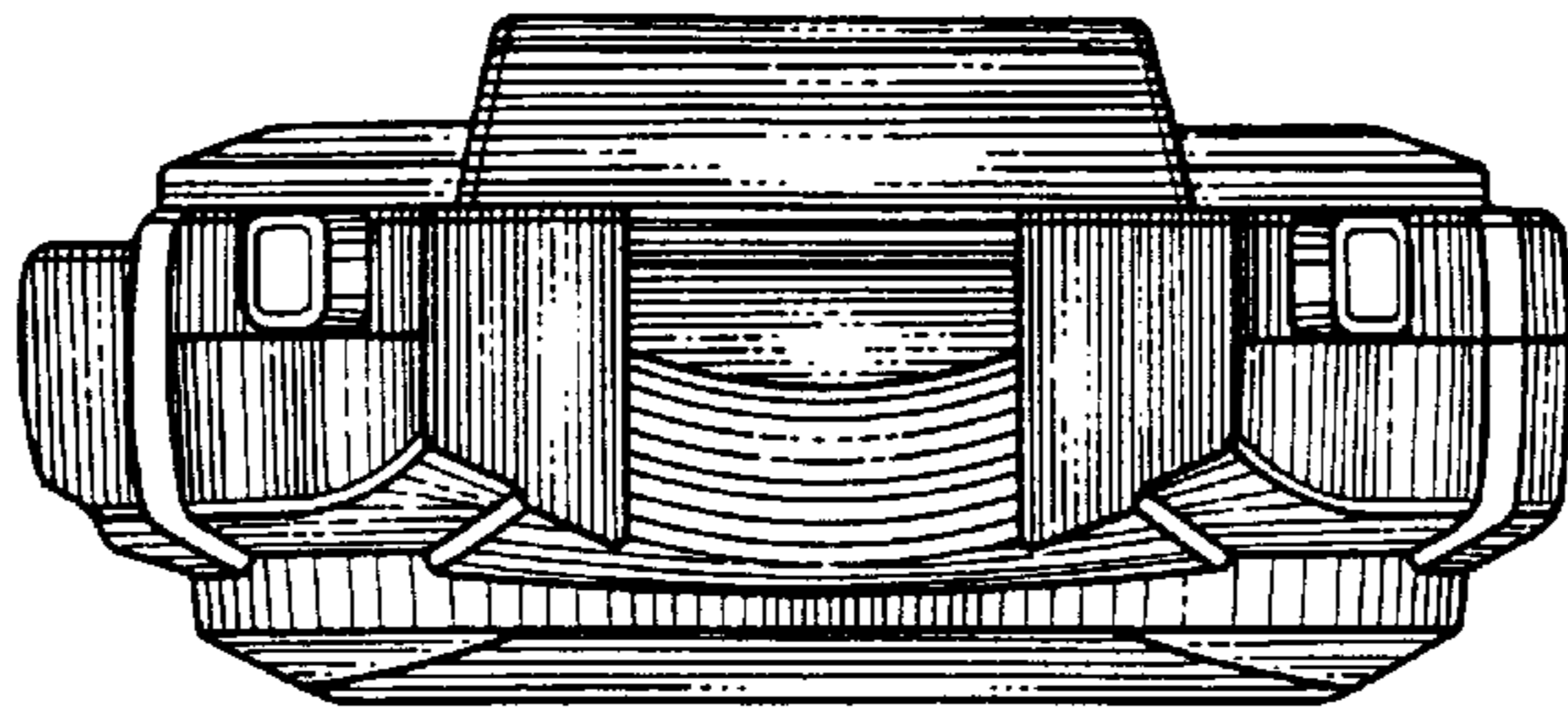

FIG. 11

FIG. 10

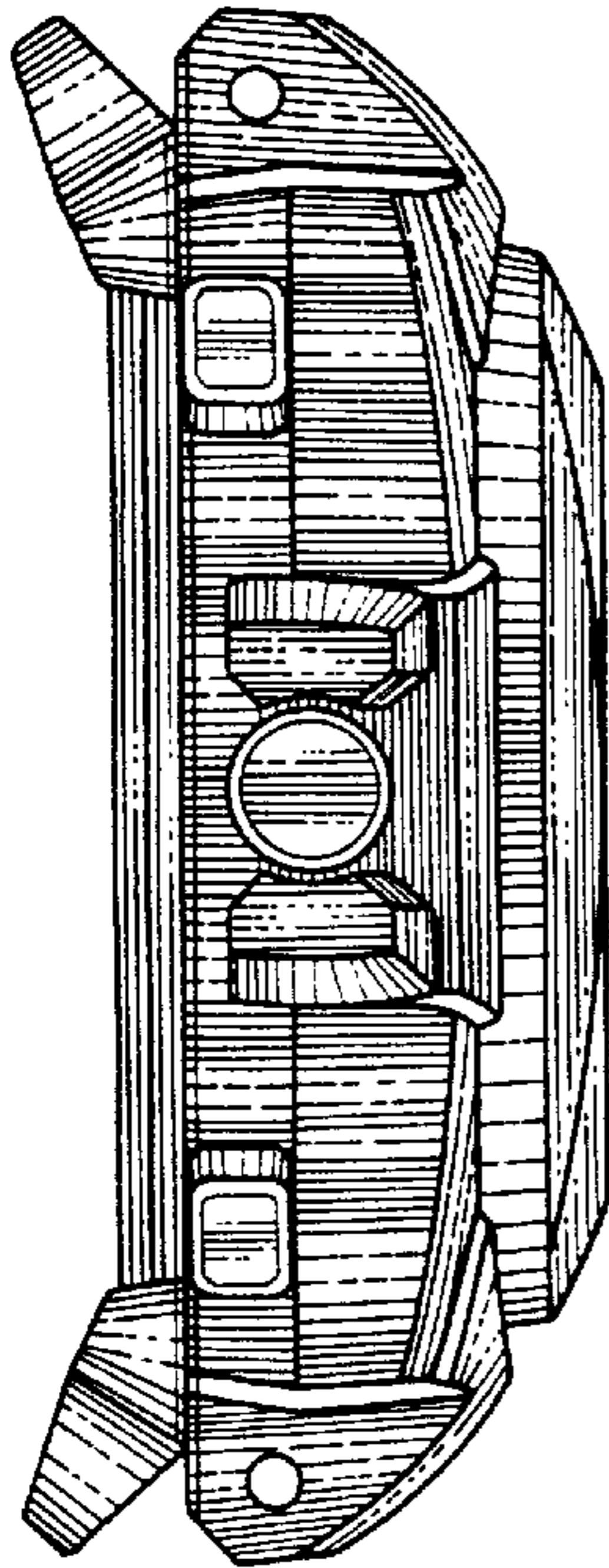

FIG. 8

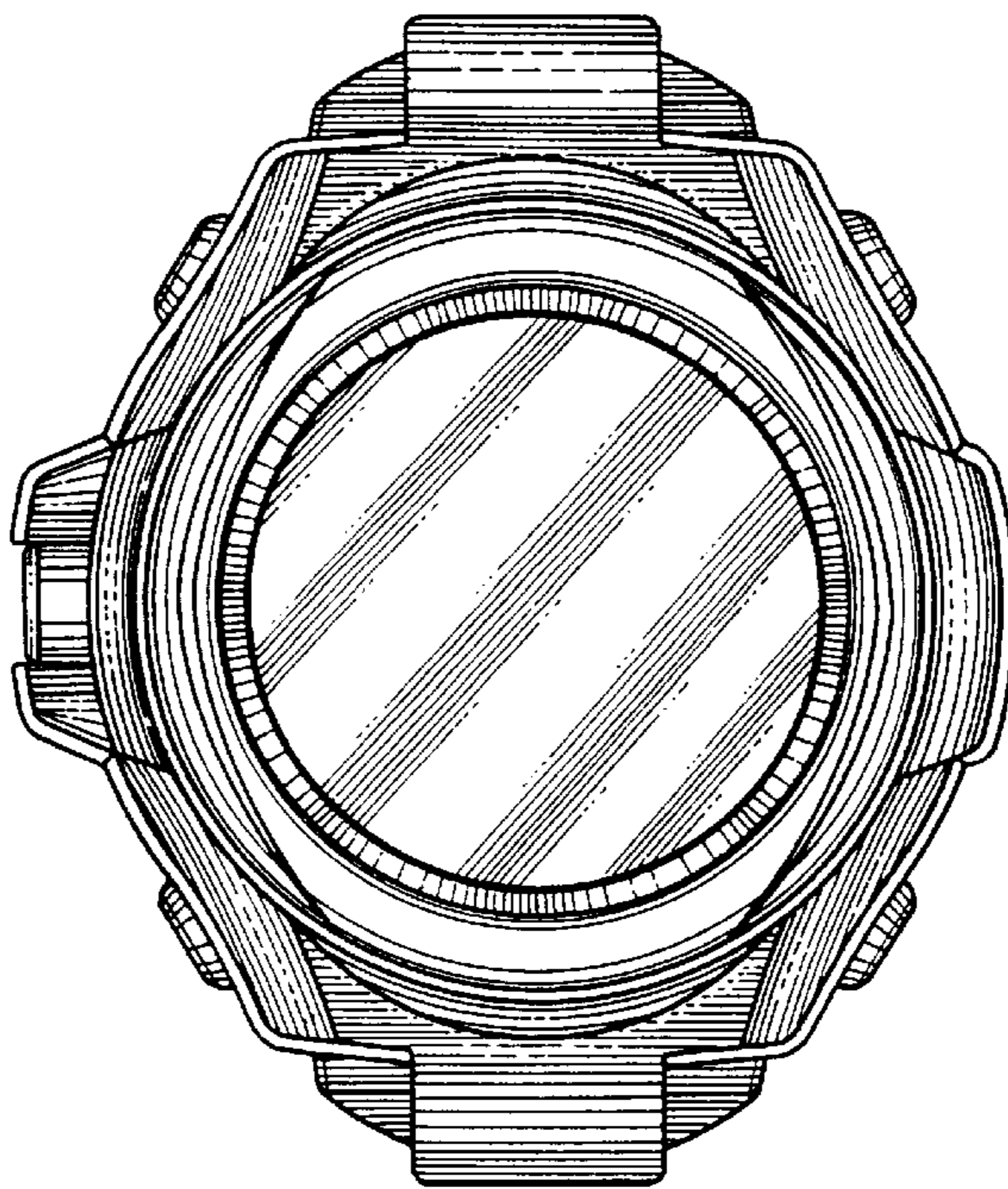

FIG. 9

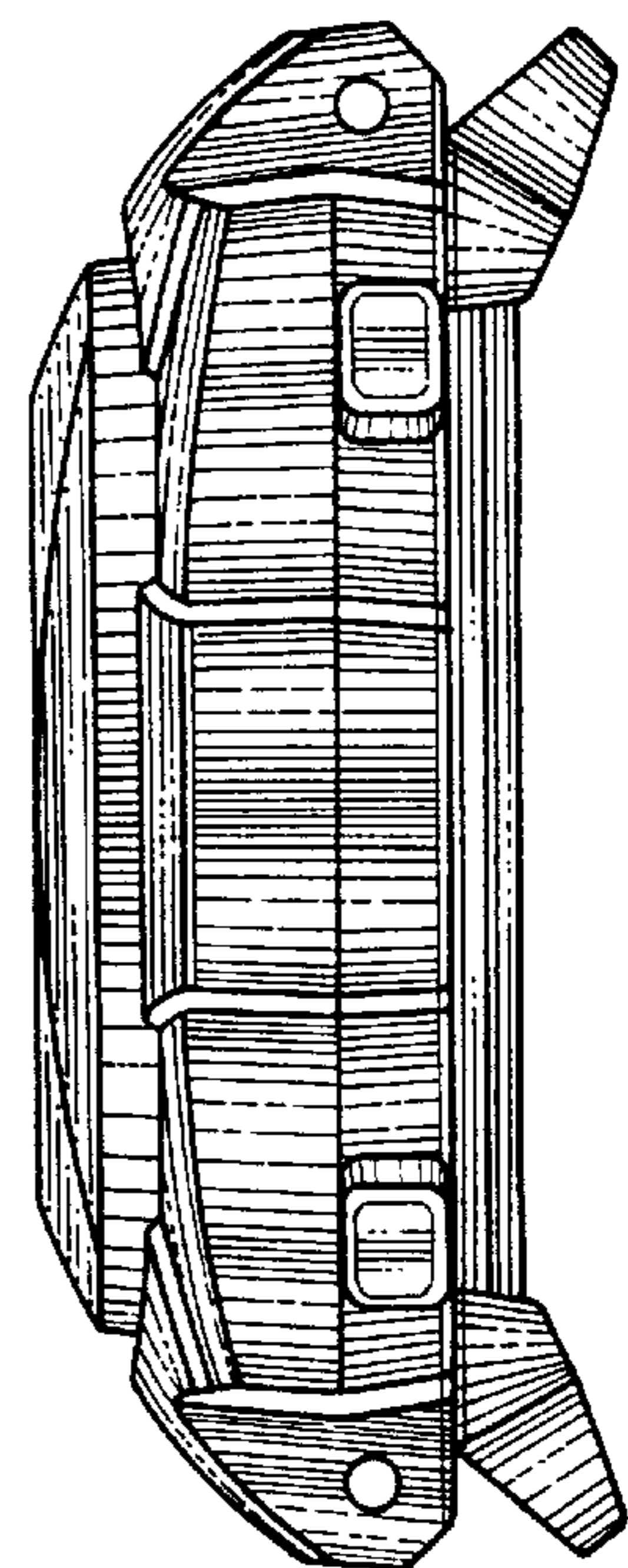
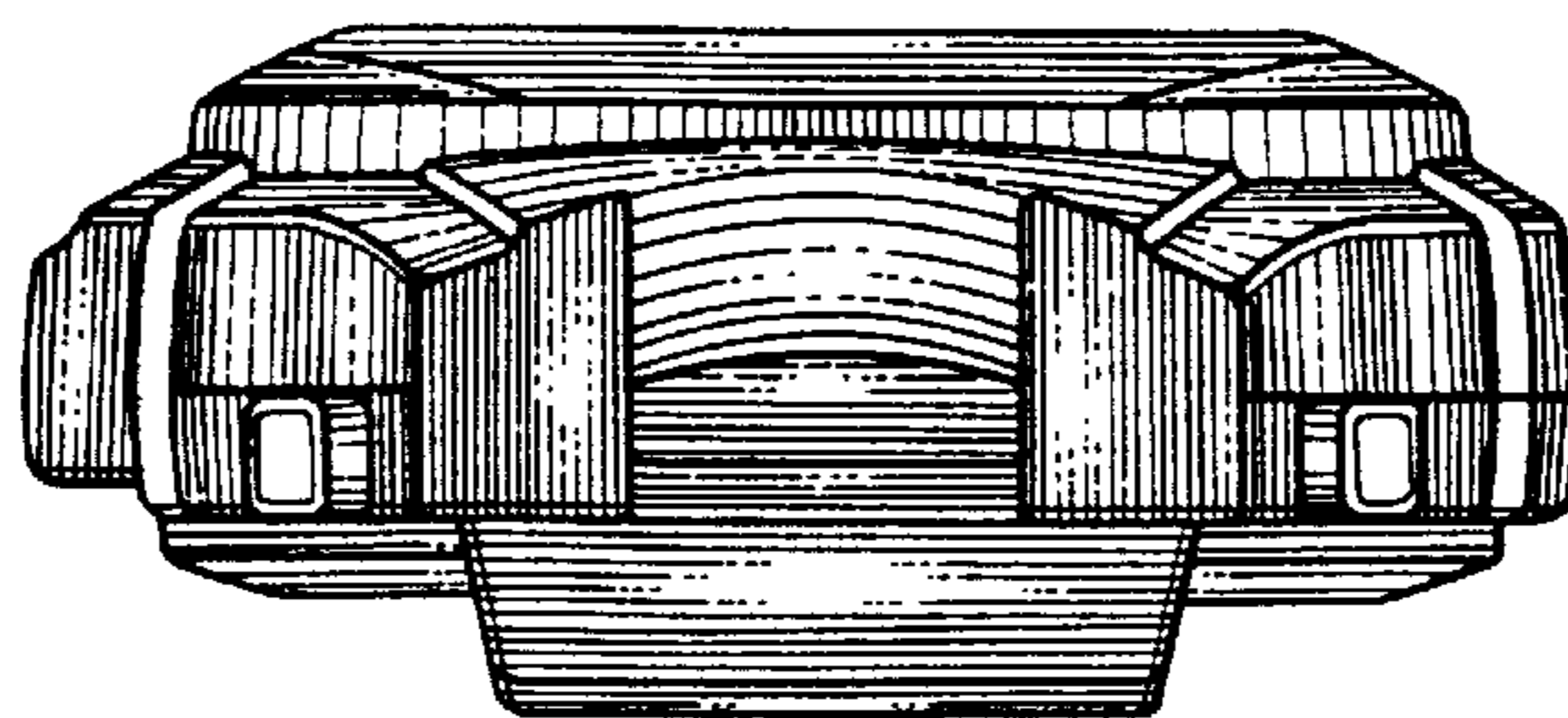

FIG. 12



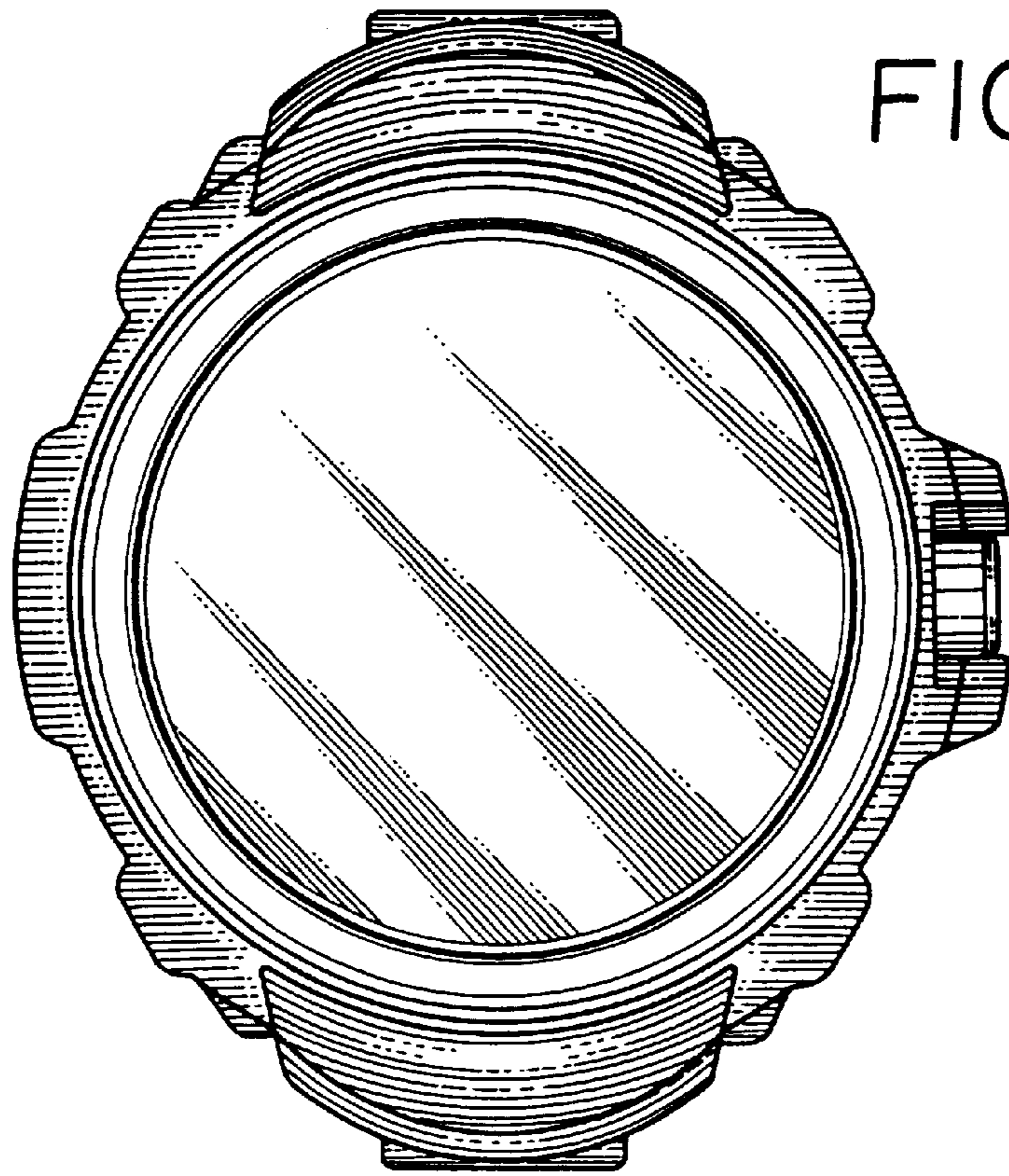

FIG. 13

FIG. 14

