



US00D420231S

United States Patent [19] Draper

[11] Patent Number: **Des. 420,231**

[45] Date of Patent: **** Feb. 8, 2000**

[54] STORAGE UNIT

[75] Inventor: **William P. Draper**, Perkasio, Pa.

[73] Assignee: **Draper DBS**, Perkasio, Pa.

[**] Term: **14 Years**

[21] Appl. No.: **29/103,778**

[22] Filed: **Apr. 15, 1999**

D. 190,655	6/1961	Borden	D6/427
D. 273,923	5/1984	Matthias	D6/445
D. 318,584	7/1991	Rouso	D6/445
D. 370,798	6/1996	Rosen	D6/446
D. 370,799	6/1996	Rosen	D6/446
D. 378,716	4/1997	Mann et al.	D6/434

Primary Examiner—Carmen H. Vales-Lado
Attorney, Agent, or Firm—Grimes & Battersby, LLP

Related U.S. Application Data

[62] Division of application No. 29/086,170, Apr. 7, 1998.

[51] LOC (7) Cl. **06-04**

[52] U.S. Cl. **D6/445; D6/434**

[58] Field of Search D6/432-448, 482,
D6/483, 427; 312/204, 257

[57] CLAIM

The ornamental design for a storage unit, as shown.

DESCRIPTION

FIG. 1 is a perspective view of a storage unit showing my new design;
FIG. 2 is a front elevational view thereof;
FIG. 3 is a top plan view thereof;
FIG. 4 is a right side elevational view thereof;
FIG. 5 is a left side elevational view thereof;
FIG. 6 is a rear elevational view thereof;
FIG. 7 is a bottom plan view thereof; and,
FIG. 8 is a sectional view taken along line 8—8 of FIG. 2.

[56] References Cited

U.S. PATENT DOCUMENTS

D. 115,119	6/1939	Marano	D6/483 X
D. 176,412	12/1955	Herrmann	D6/427

1 Claim, 7 Drawing Sheets

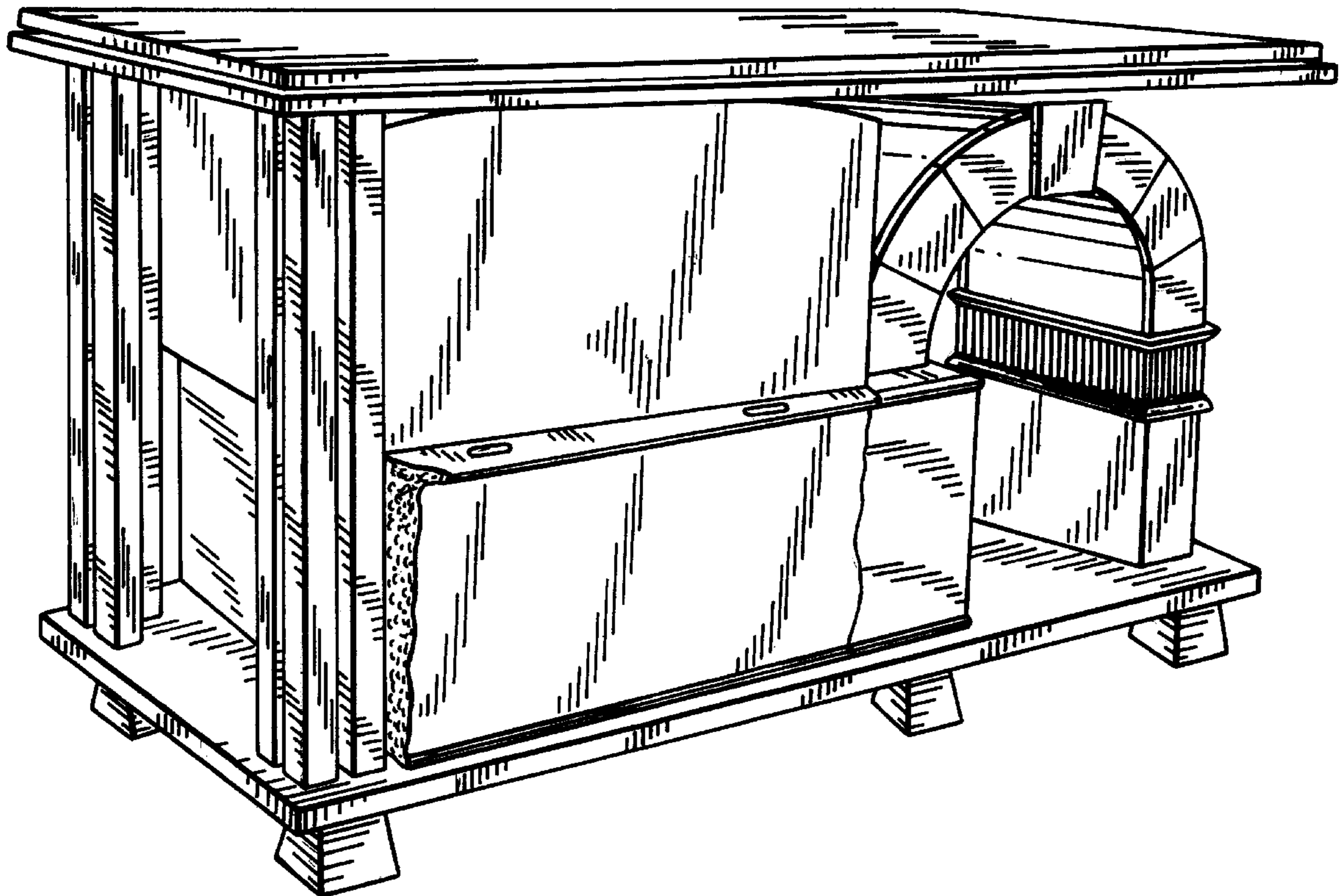

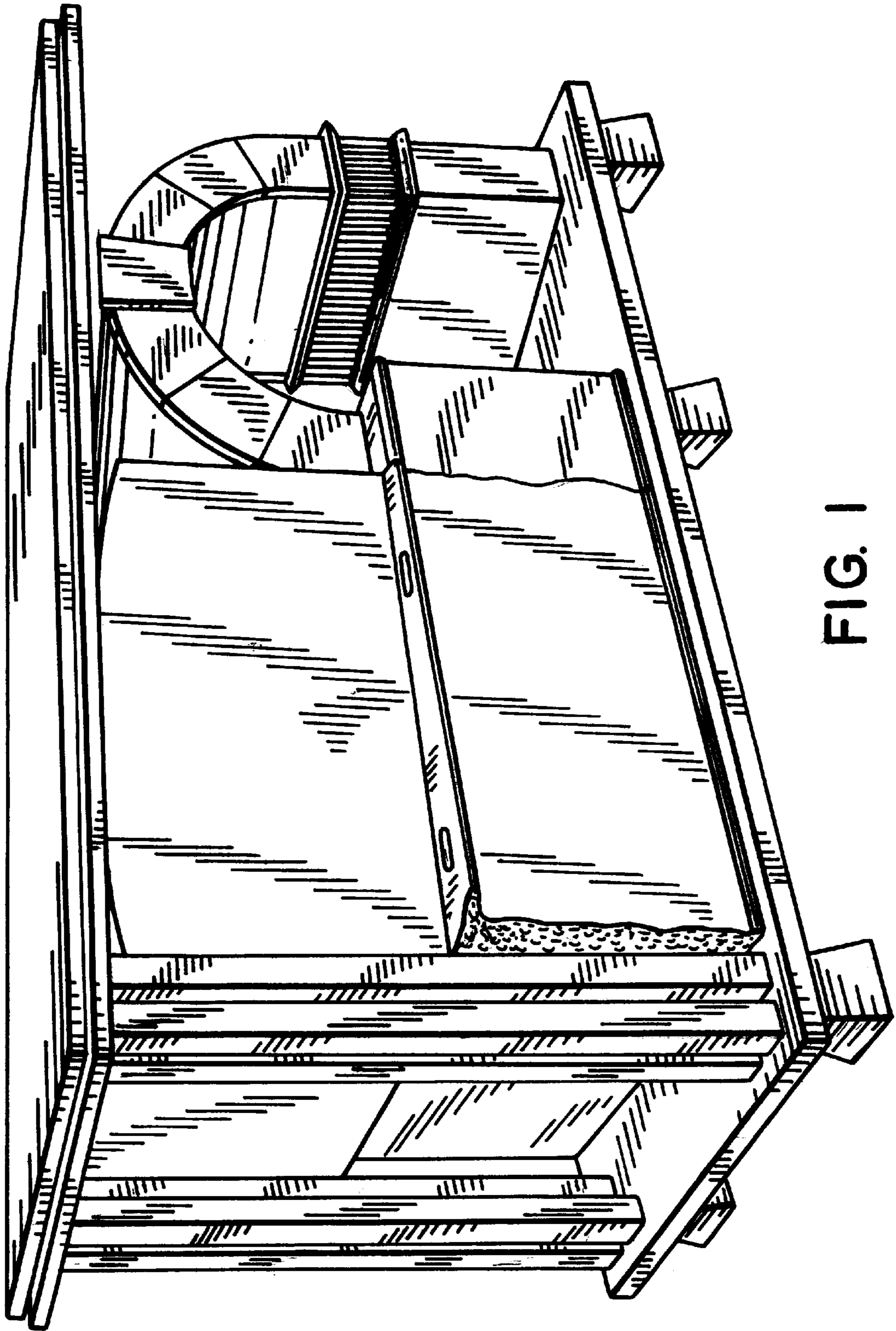

FIG. 1

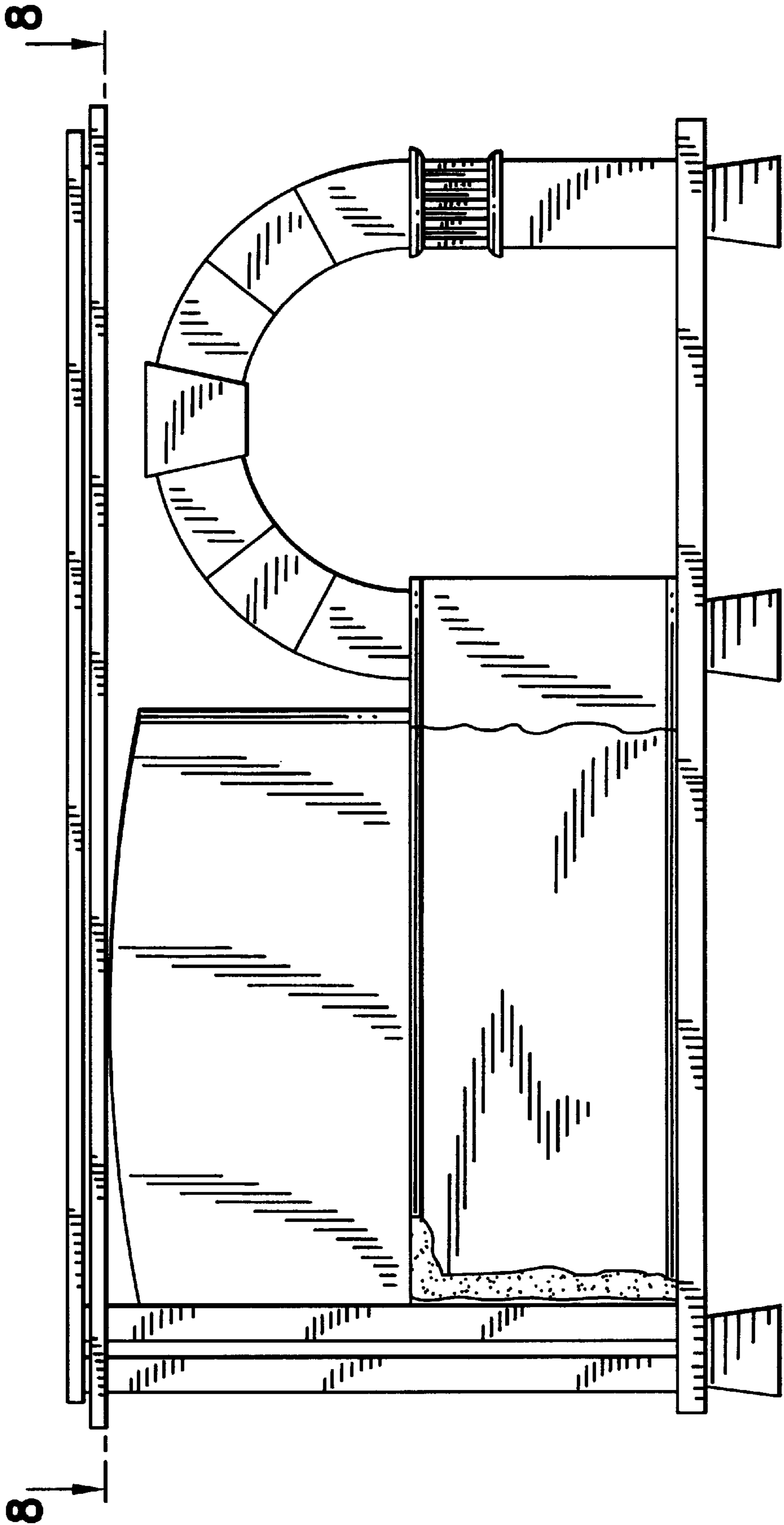

FIG.2

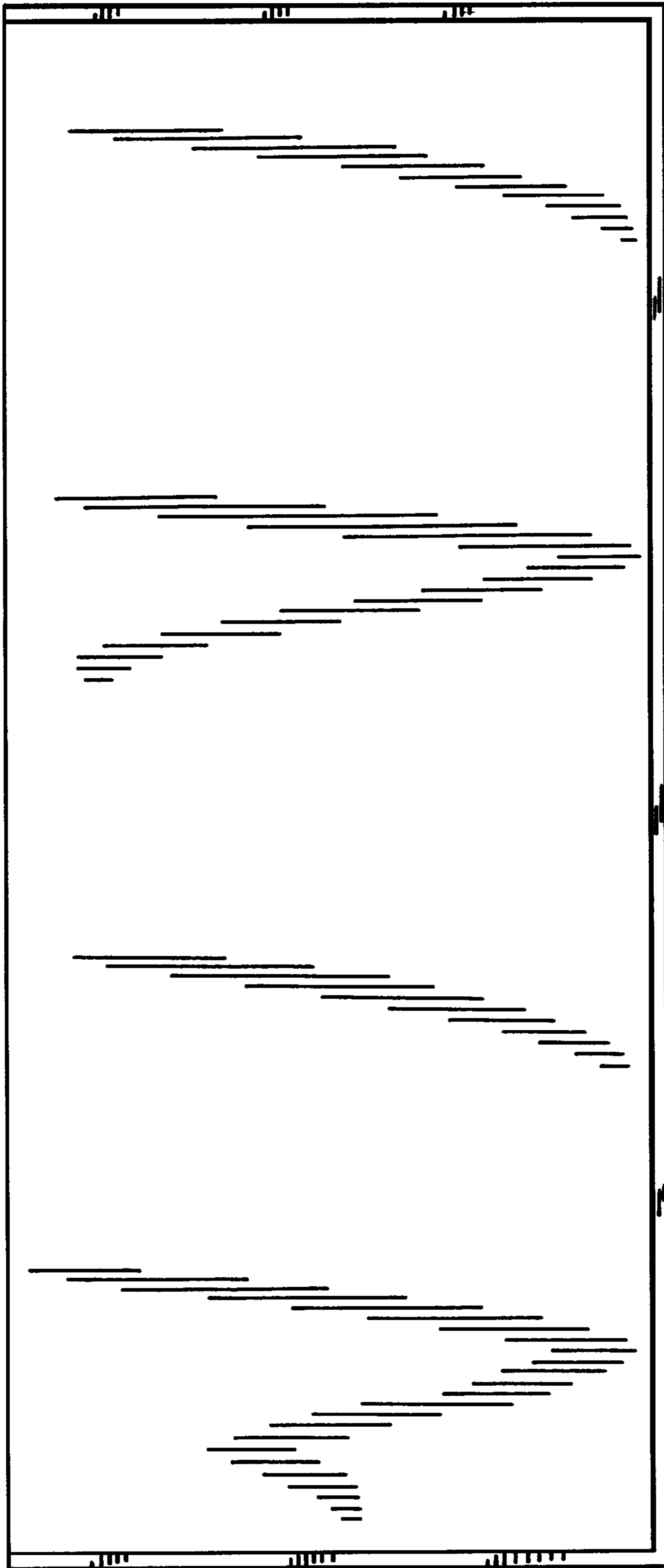

FIG. 3

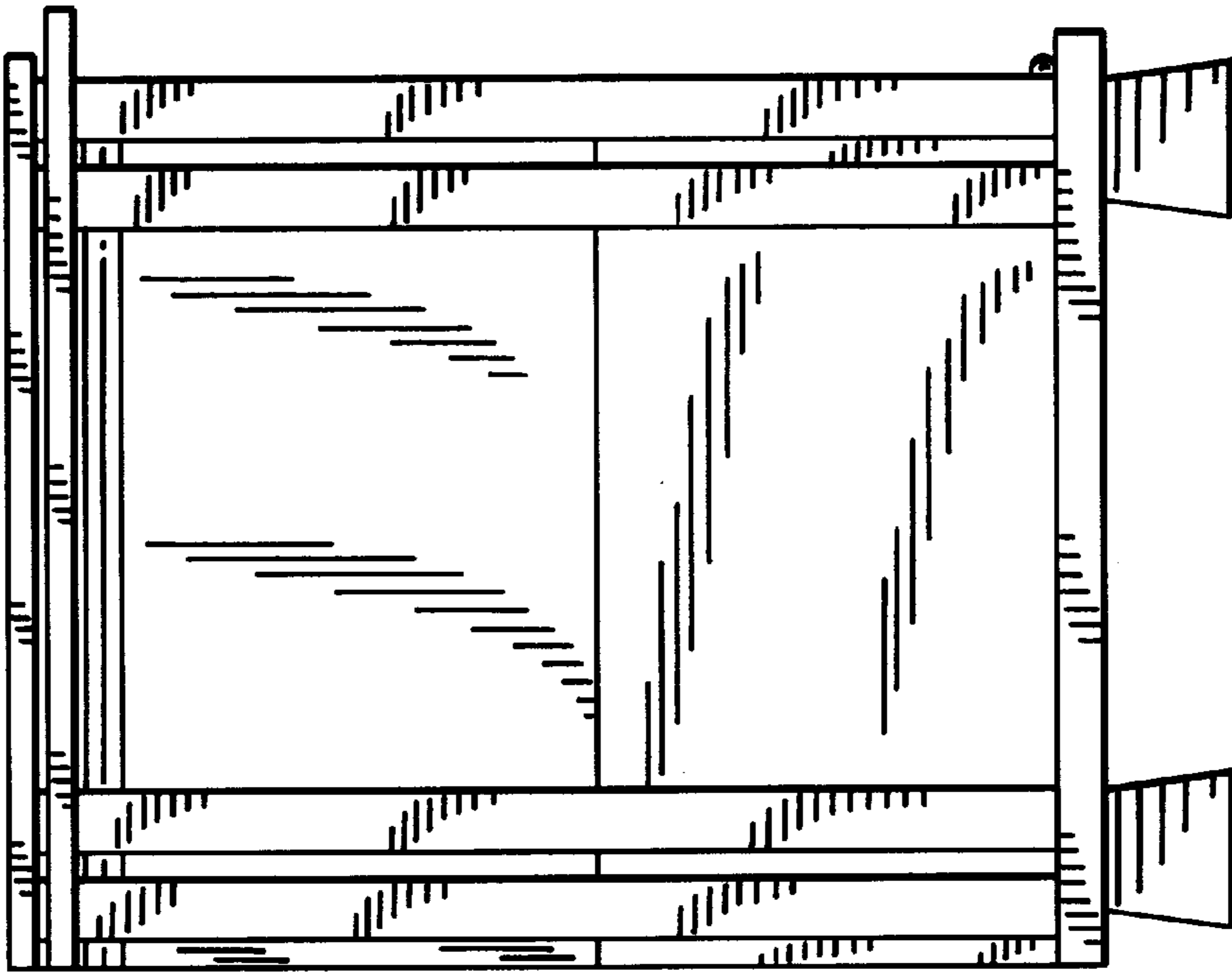

FIG. 5

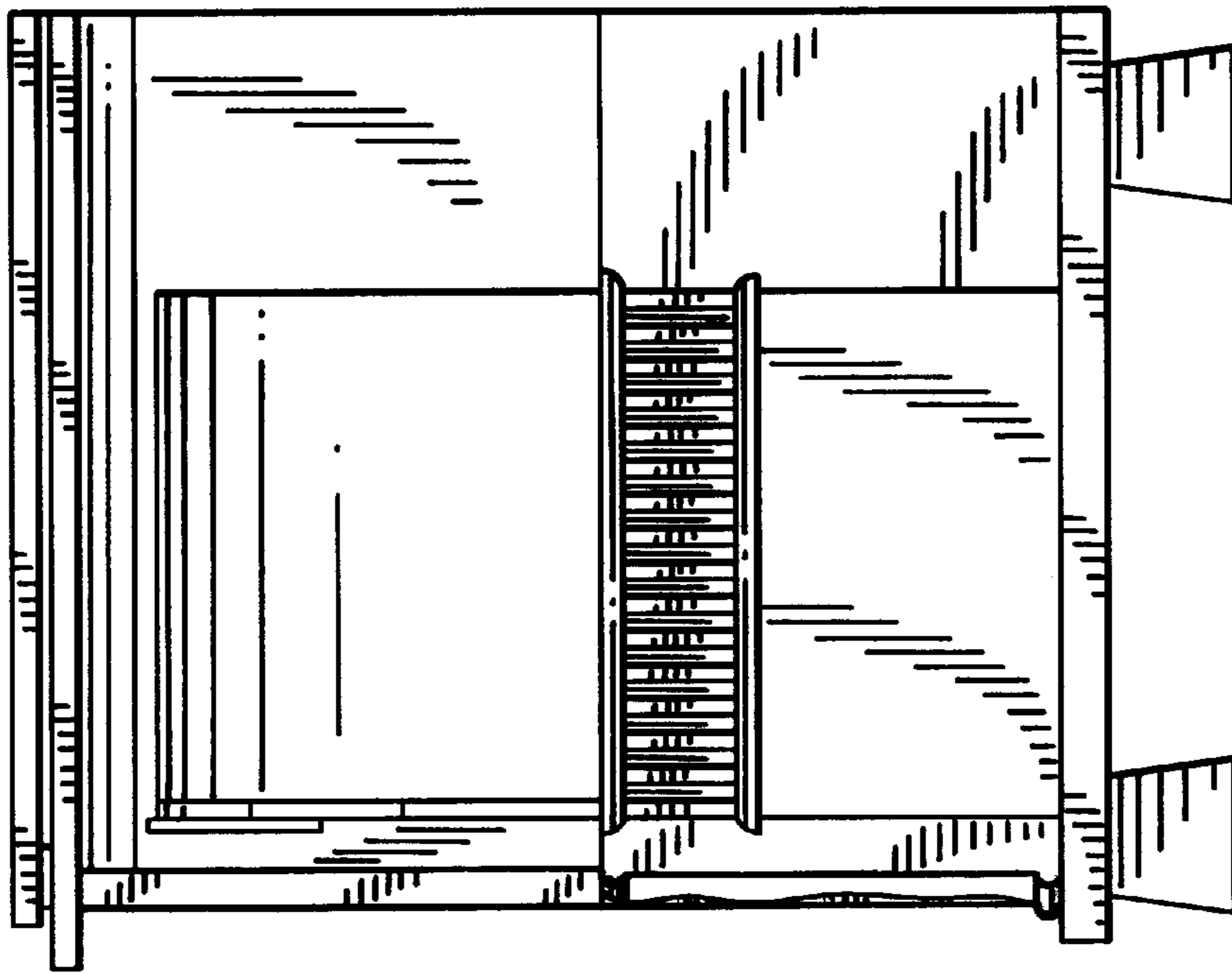

FIG. 4

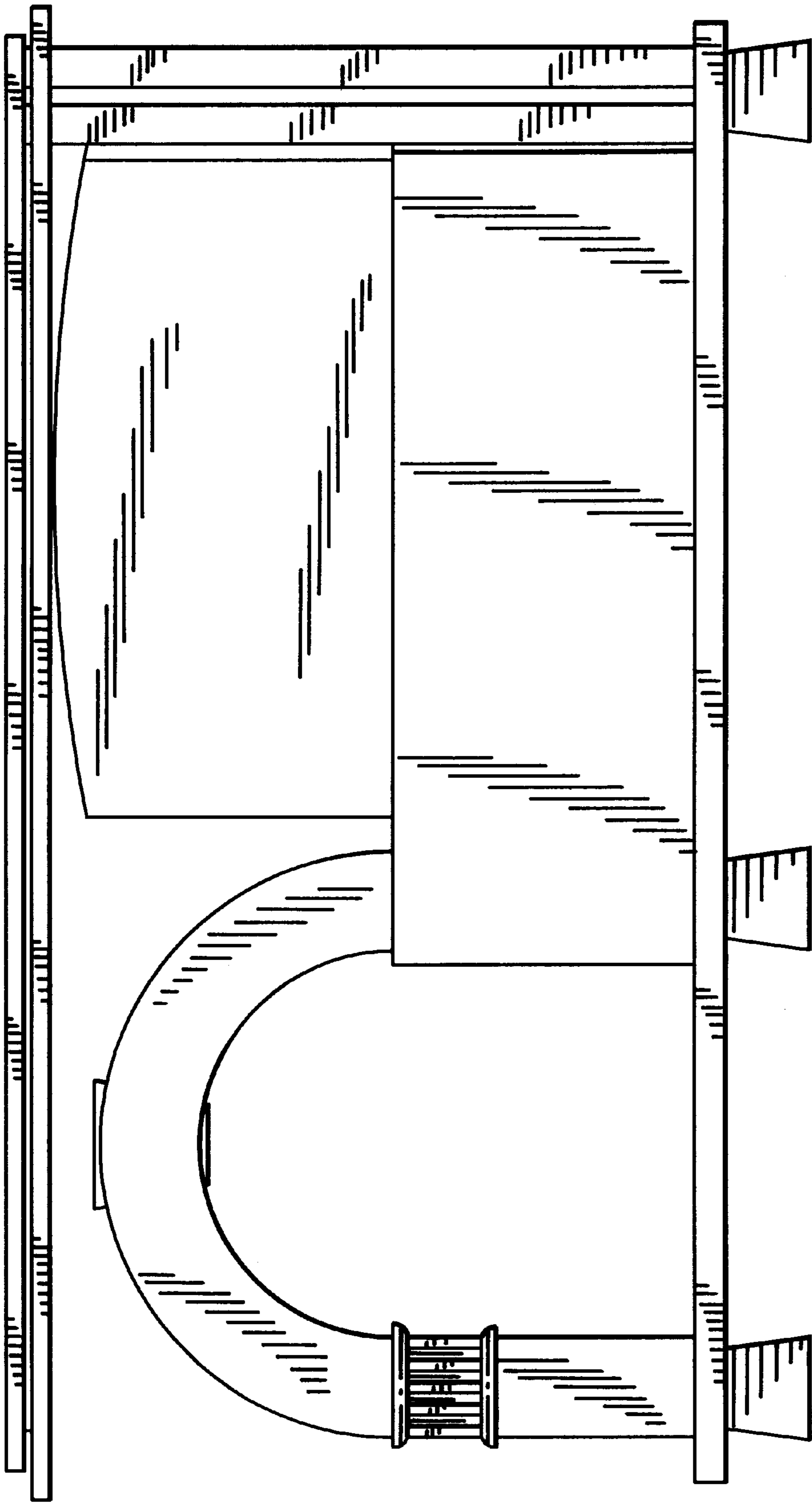

FIG. 6

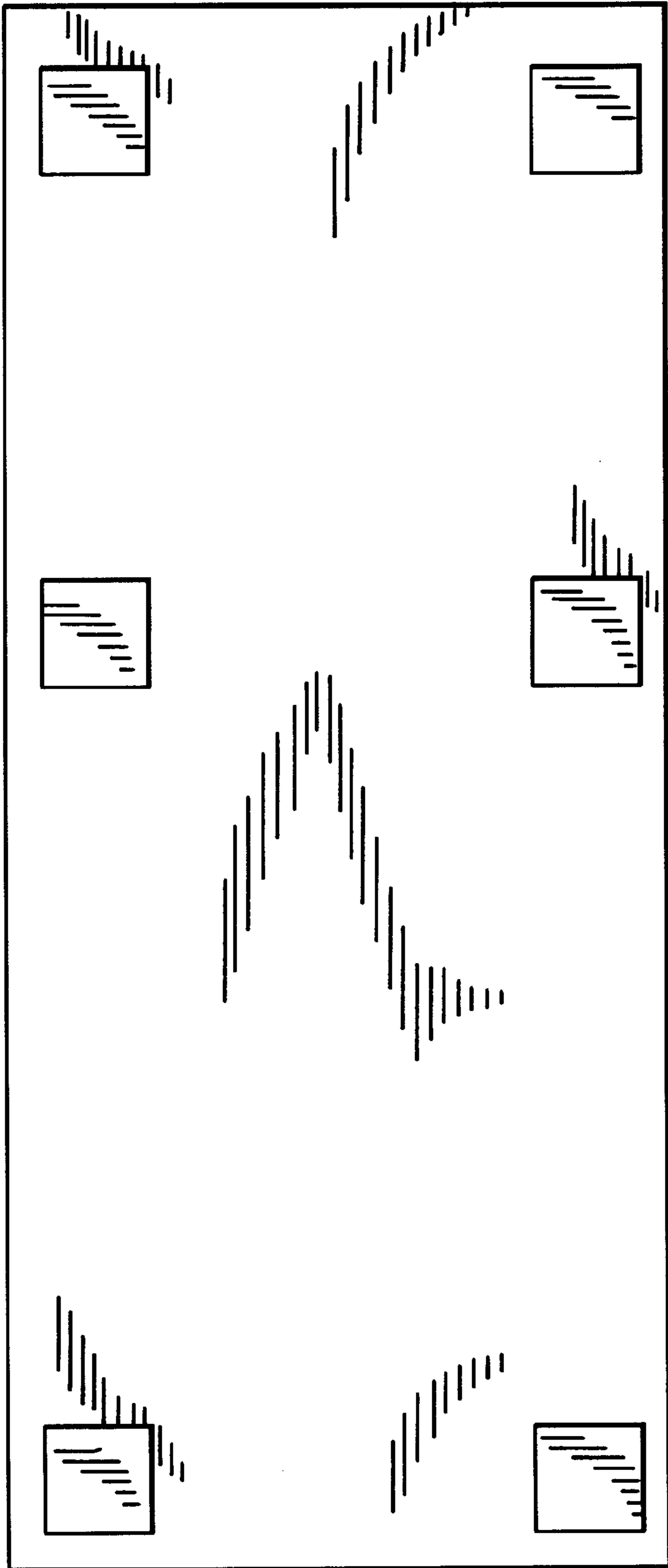

FIG.7

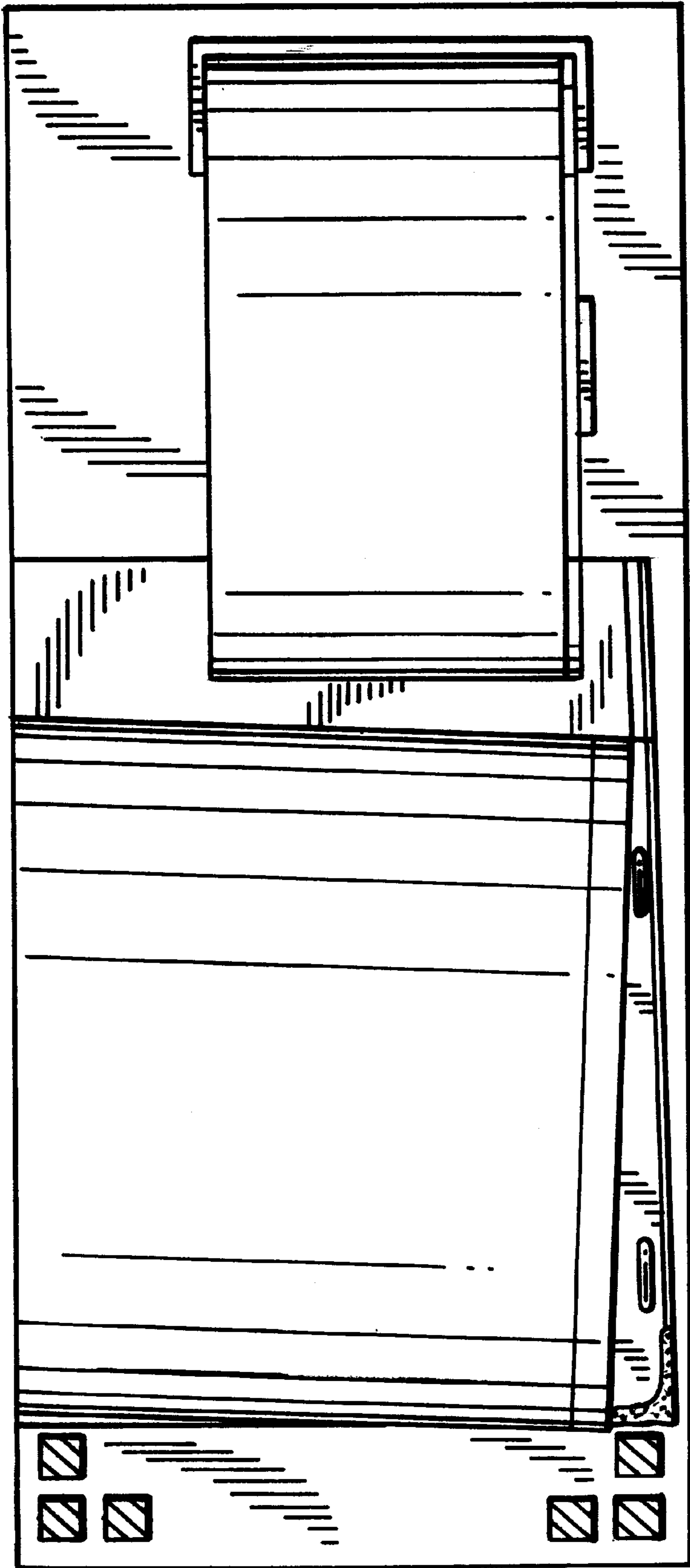

FIG. 8