



US00D420019S

United States Patent [19]

[11] **Patent Number: Des. 420,019**

Tachibana et al.

[45] **Date of Patent: ** Feb. 1, 2000**

[54] **HOLE PUNCHER FOR PRINTING PLATE**

[57] **CLAIM**

[75] Inventors: **Yuichiro Tachibana; Nobuhiko Karafuji**, both of Tokyo; **Hideki Dohmoto**, Hiroshima, all of Japan

The ornamental design for a hole puncher for printing plate, as shown and described.

[73] Assignee: **Ryobi Ltd.**, Fuchu, Japan

DESCRIPTION

[**] Term: **14 Years**

FIG. 1 is a top, left perspective view of a first embodiment of a hole puncher for printing plate showing my new design; FIG. 2 is a top, right perspective view thereof; FIG. 3 is a top plan view thereof; FIG. 4 is a front elevational view thereof; FIG. 5 is a right side elevational view thereof; FIG. 6 is a rear elevational view thereof; FIG. 7 is a left side elevational view thereof; and FIG. 8 is a bottom plan view thereof; FIG. 9 is a top, left perspective view of a second embodiment of a hole puncher for printing plate showing our new design; FIG. 10 is a top, right perspective view thereof; FIG. 11 is a top plan view thereof; FIG. 12 is a front elevational view thereof; FIG. 13 is a right side elevational view thereof; FIG. 14 is a rear elevational view thereof; FIG. 15 is a left side elevational view thereof; and, FIG. 16 is a bottom plan view thereof.

[21] Appl. No.: **29/097,202**

[22] Filed: **Dec. 1, 1998**

[30] **Foreign Application Priority Data**

Jun. 24, 1998 [JP] Japan 10-17947

[51] **LOC (7) Cl.** **15-09**

[52] **U.S. Cl.** **D15/128**

[58] **Field of Search** D15/128; 30/316, 30/113.1; 83/684, 549, 571, 29, 37, 53, 100, 127, 428, 917; 76/101.1, 107.8; 72/370.04

[56] **References Cited**

U.S. PATENT DOCUMENTS

D. 274,817 7/1984 Jenkins D15/128

Primary Examiner—Antoine Duval Davis
Attorney, Agent, or Firm—Foley & Lardner

1 Claim, 10 Drawing Sheets

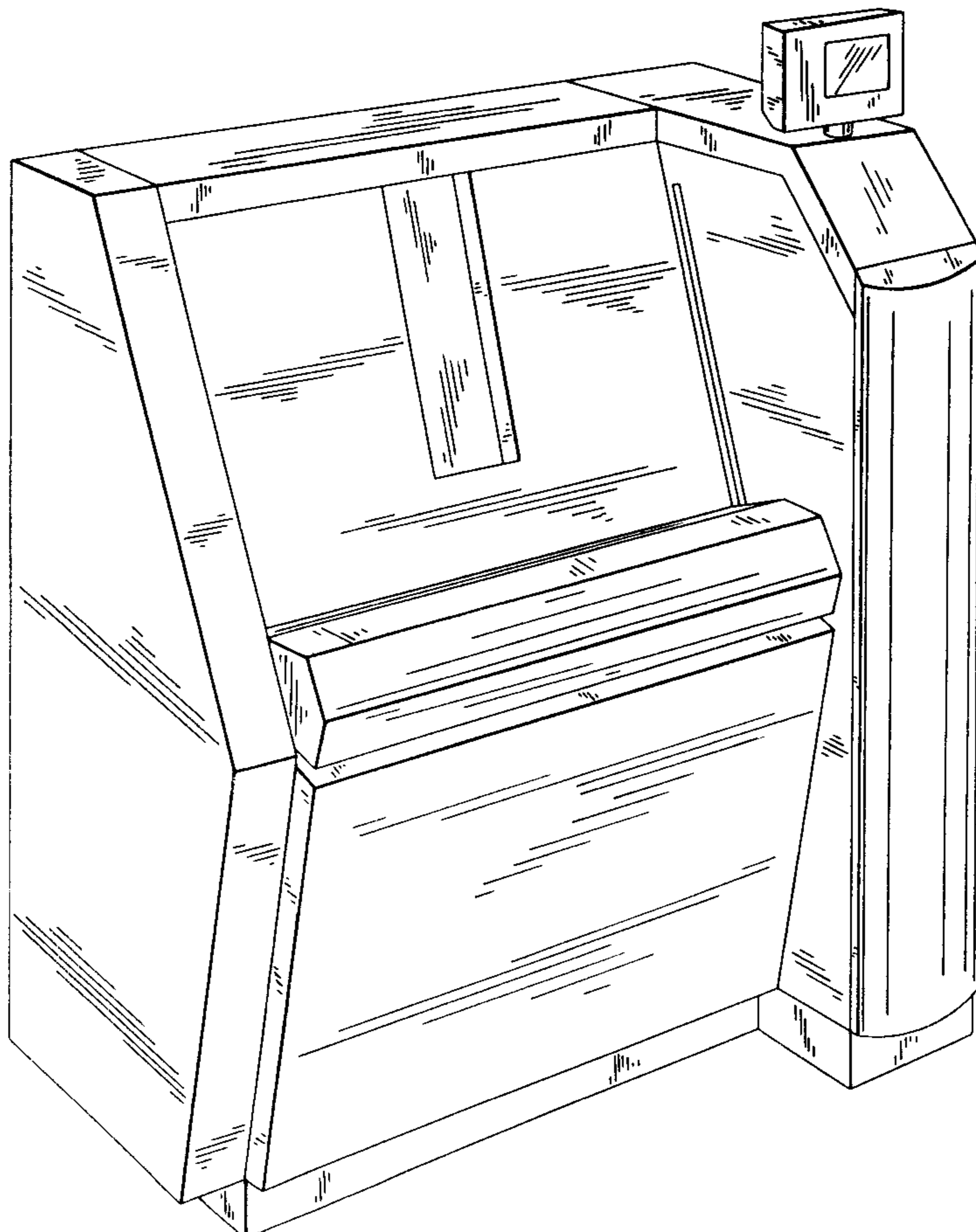

FIG. 1

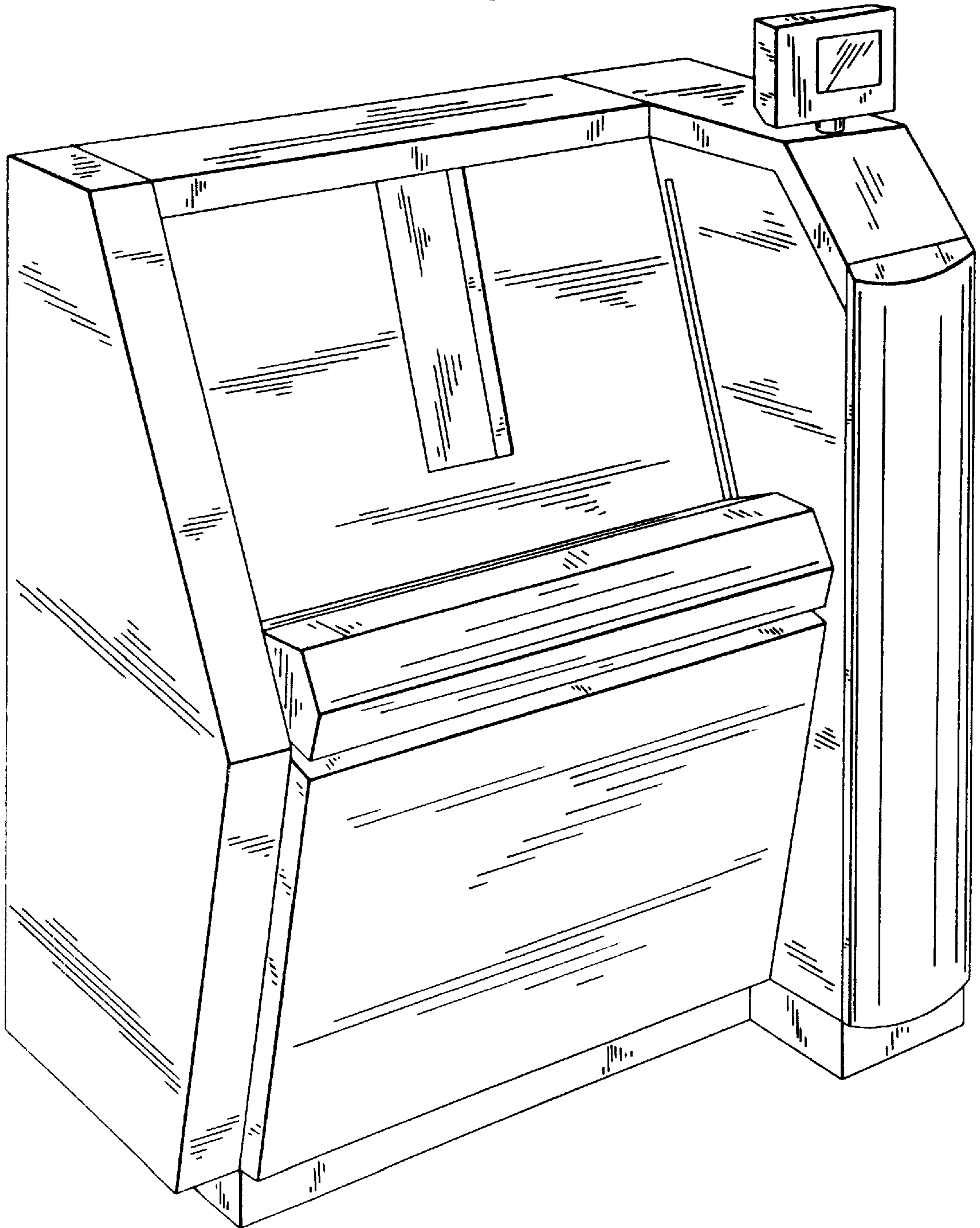

FIG. 2

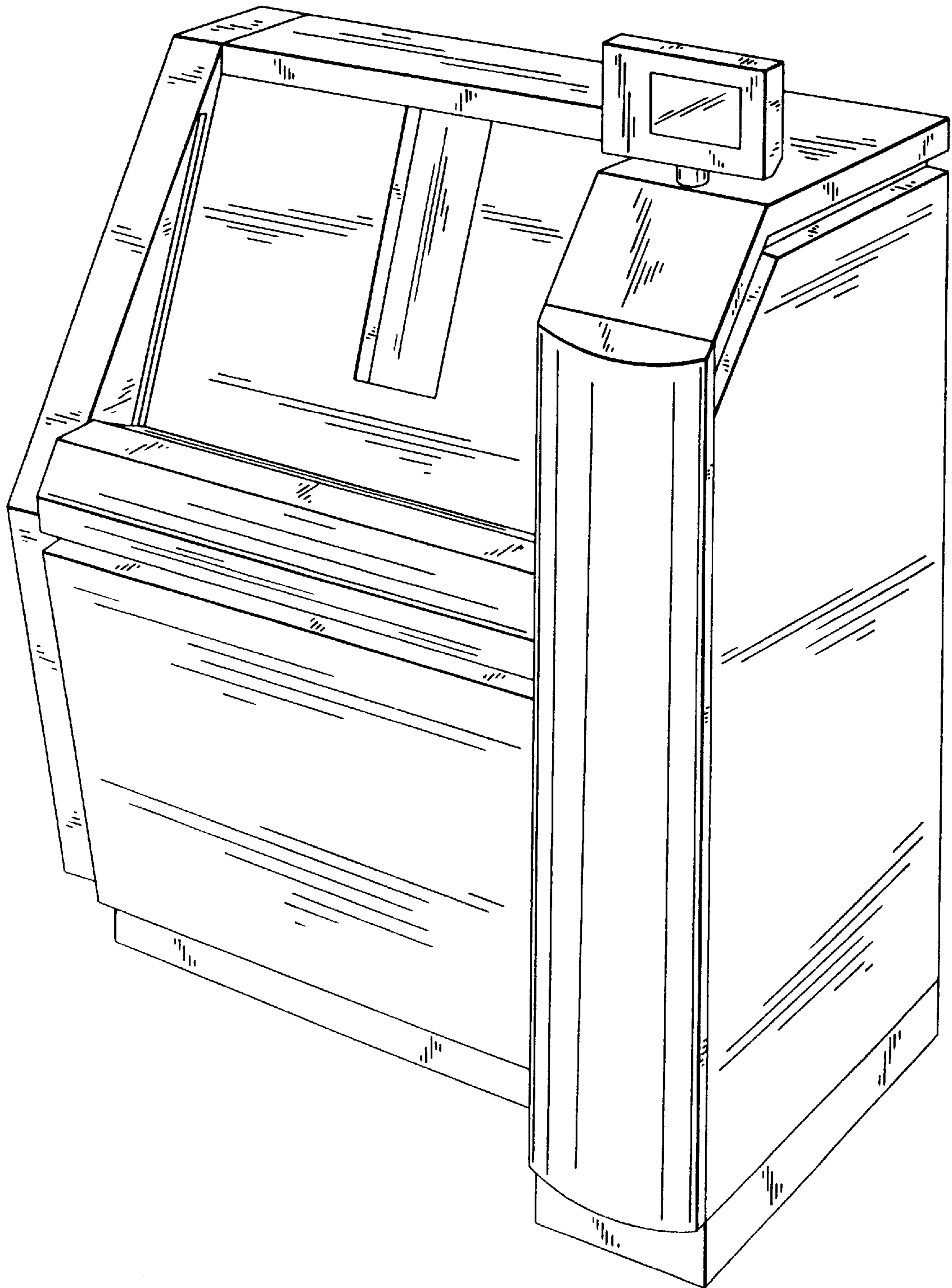

FIG. 3

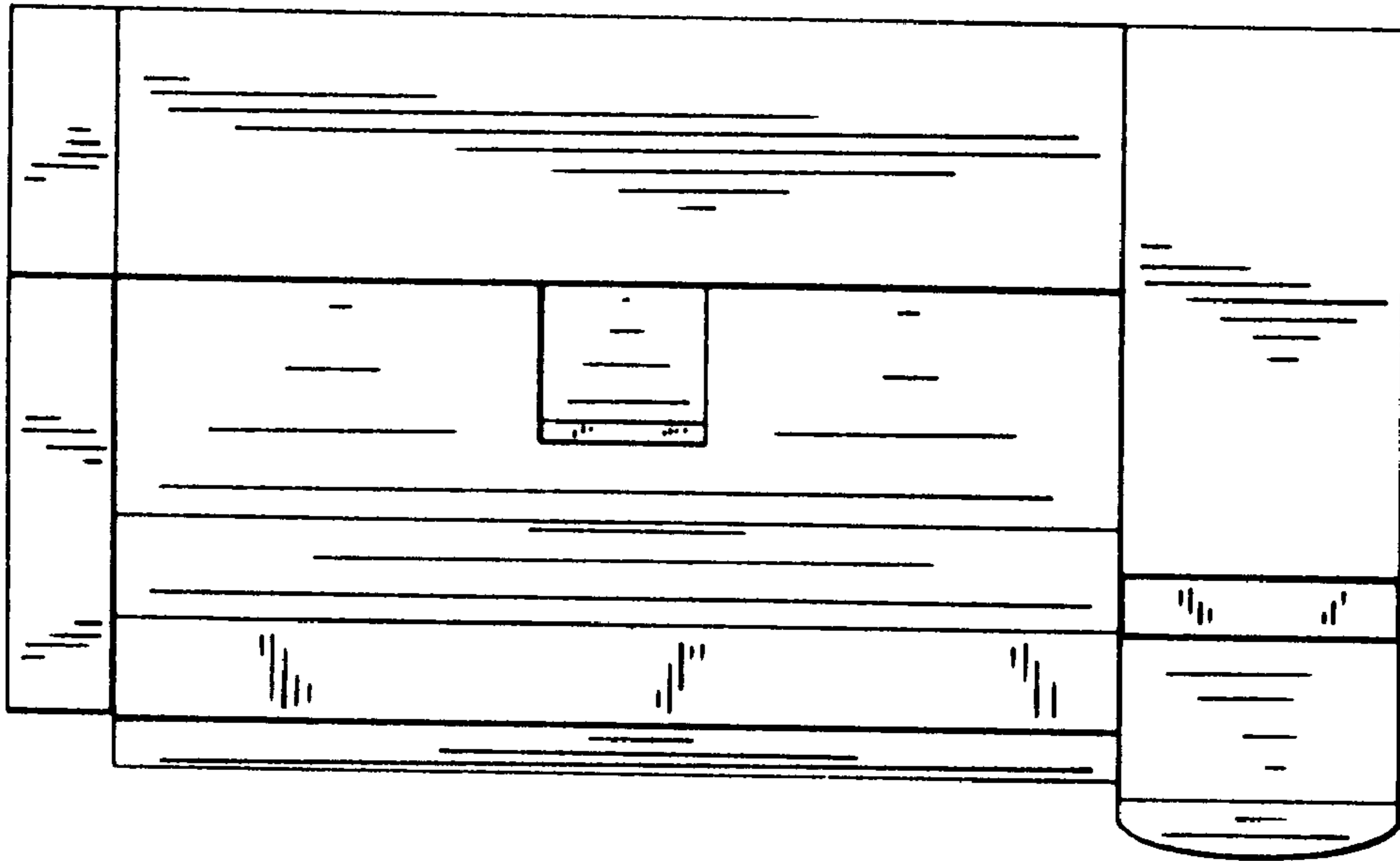

FIG. 8

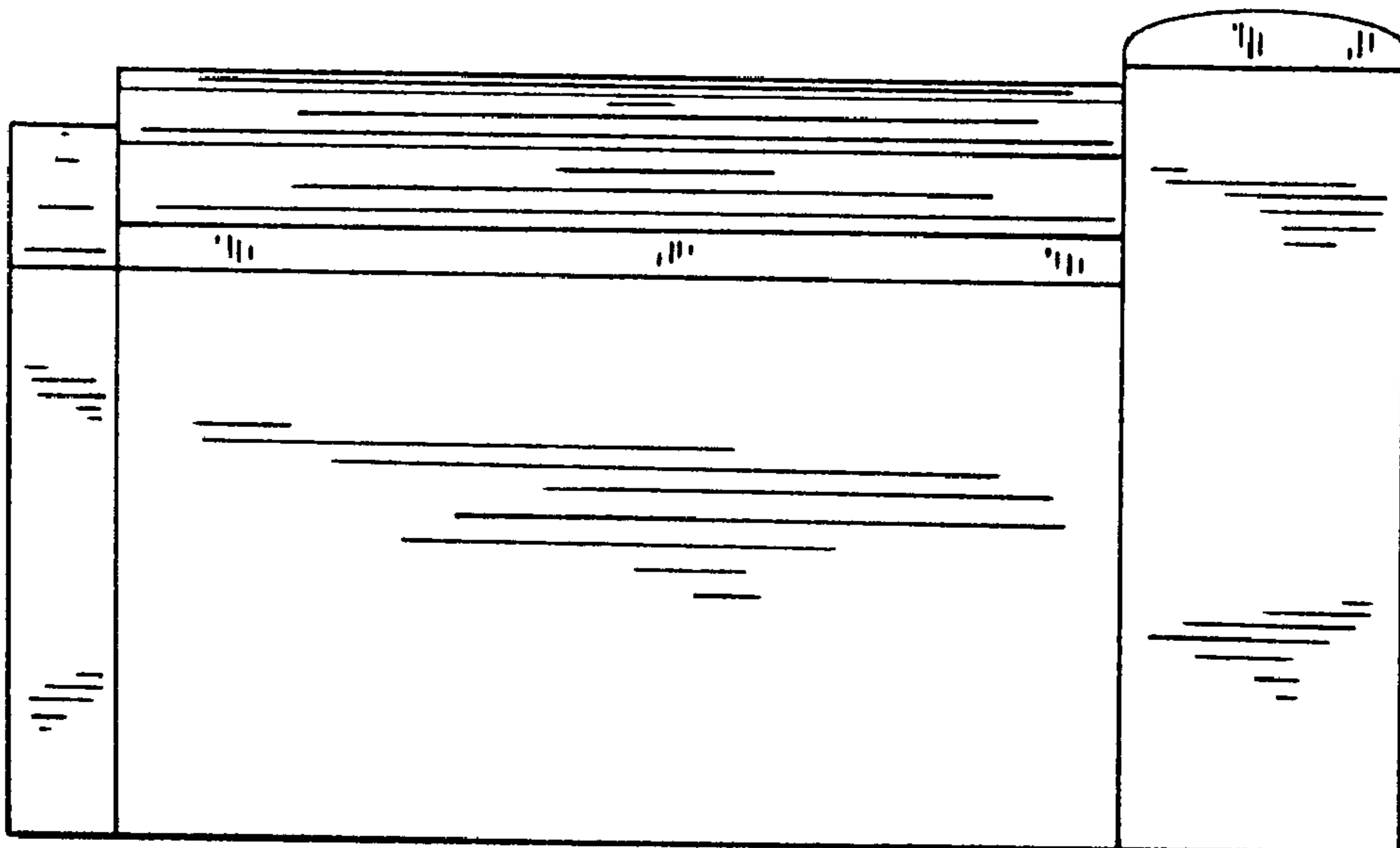

FIG. 4

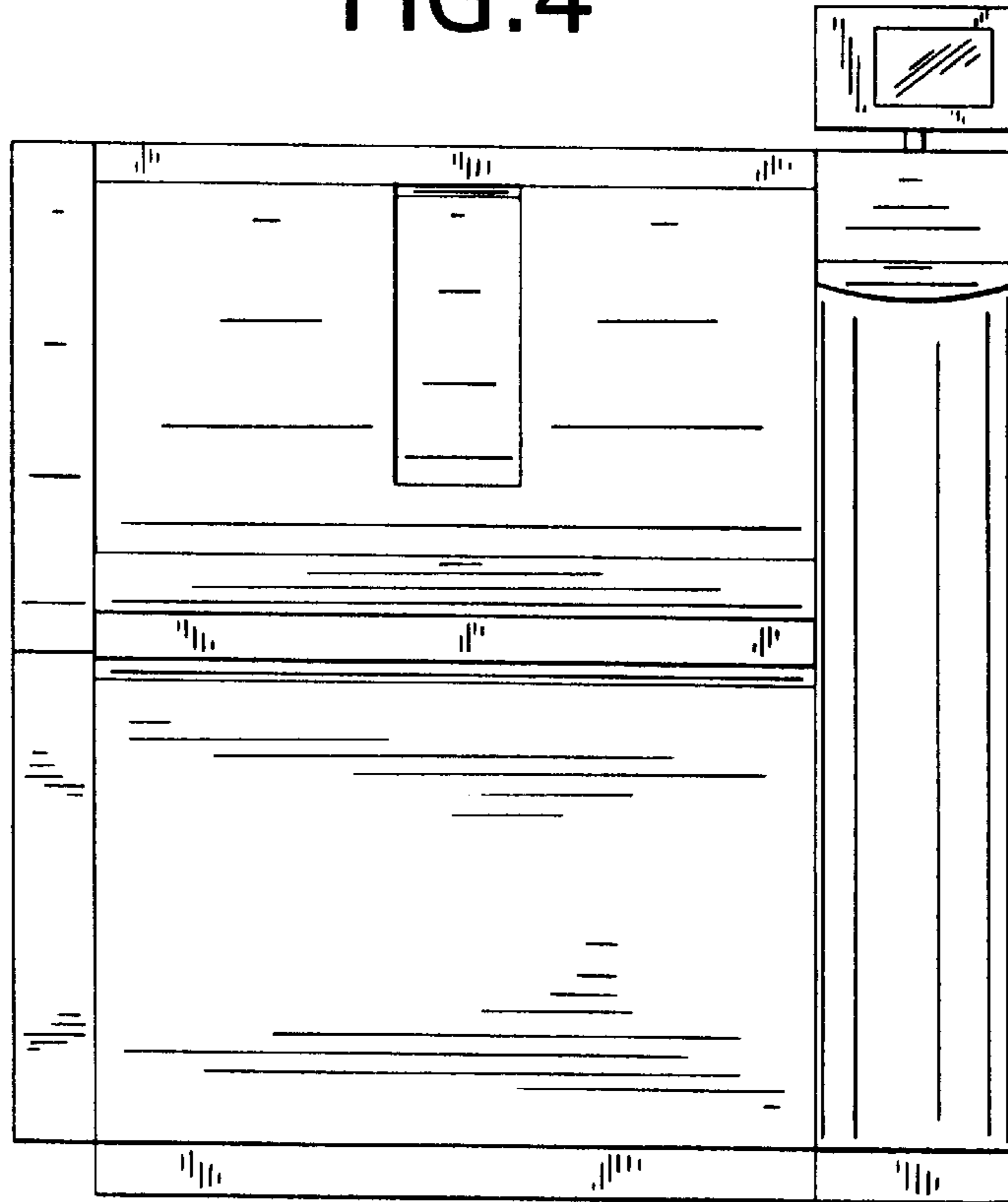

FIG. 6

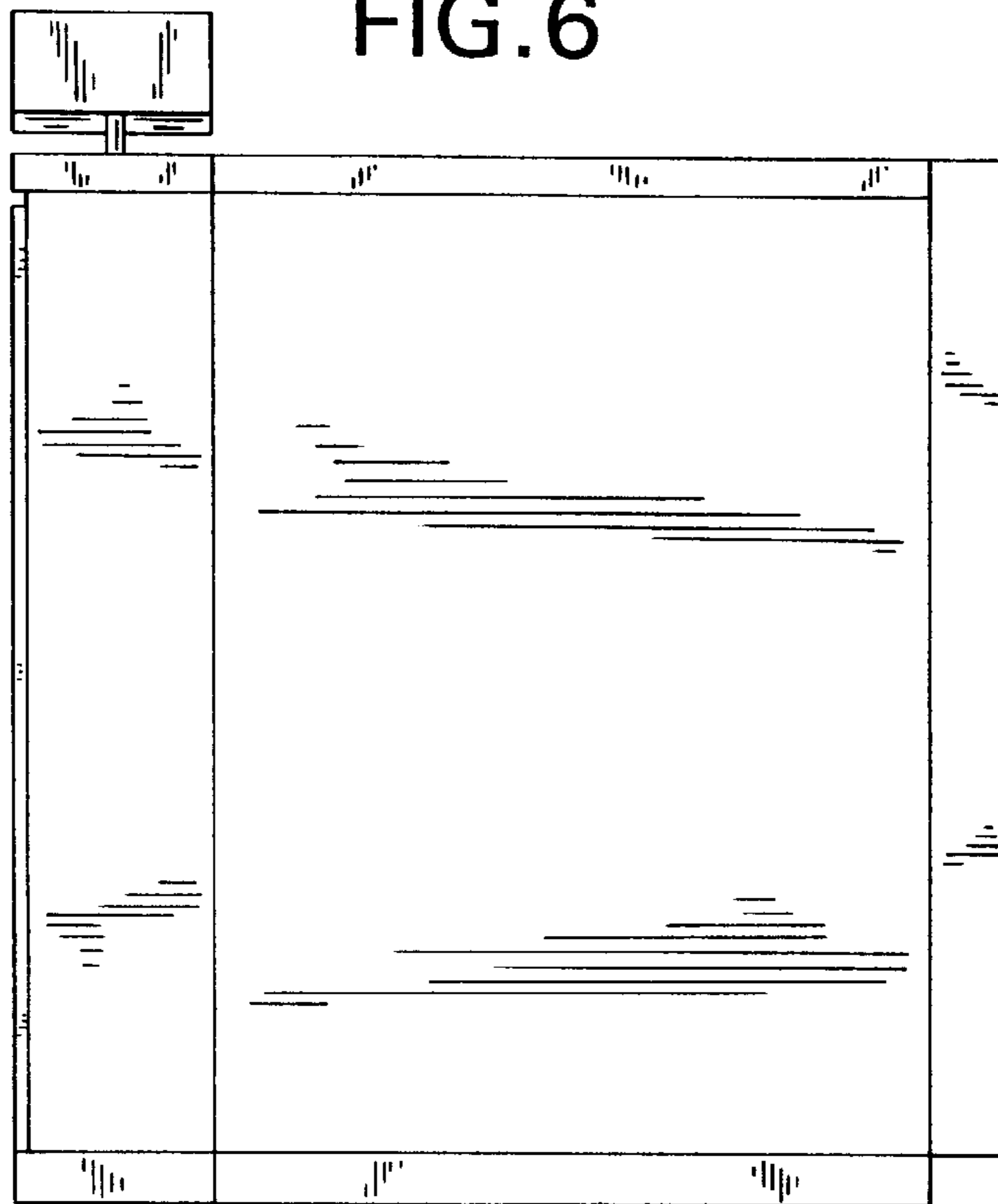

FIG.5

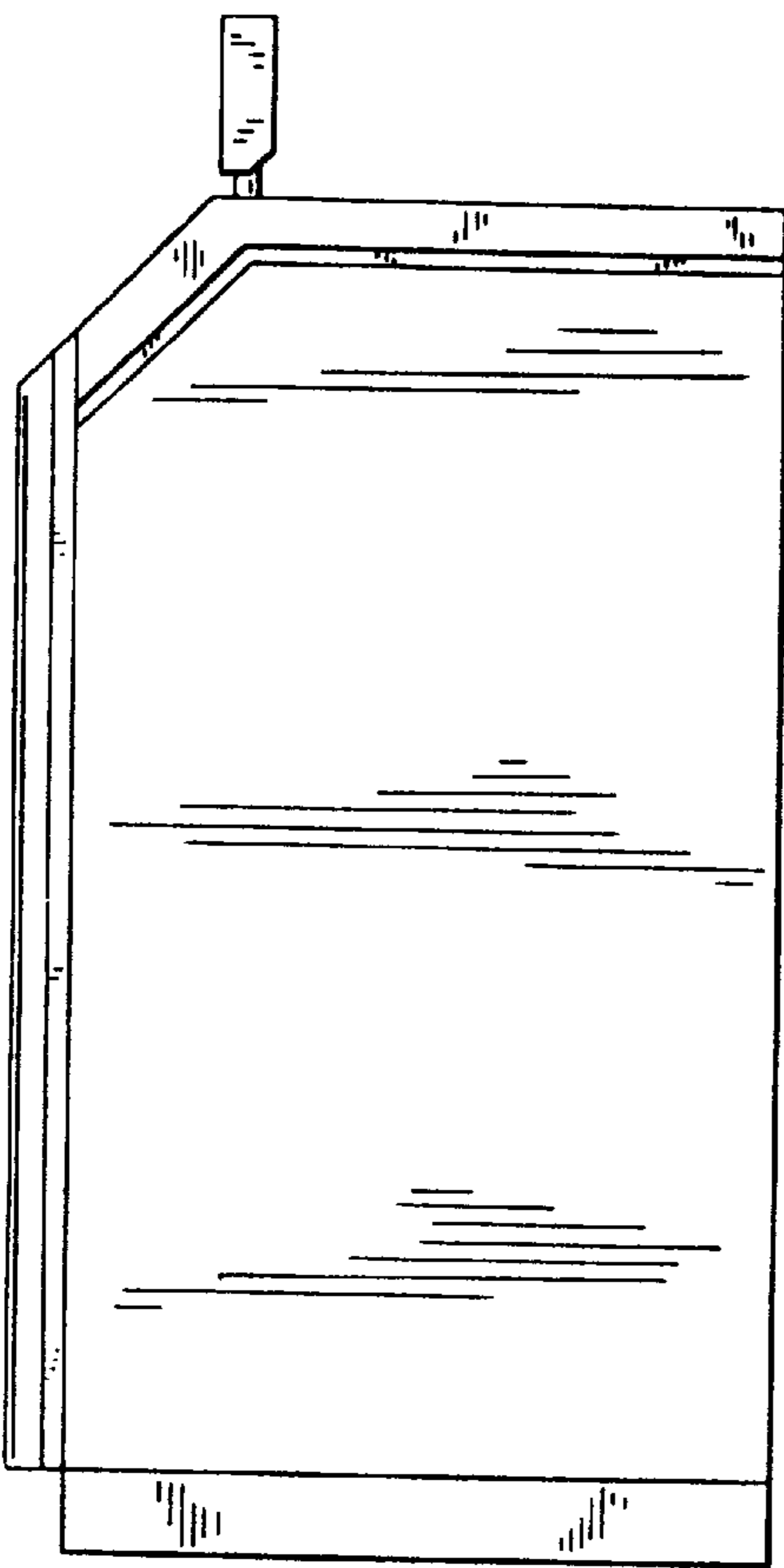

FIG.7

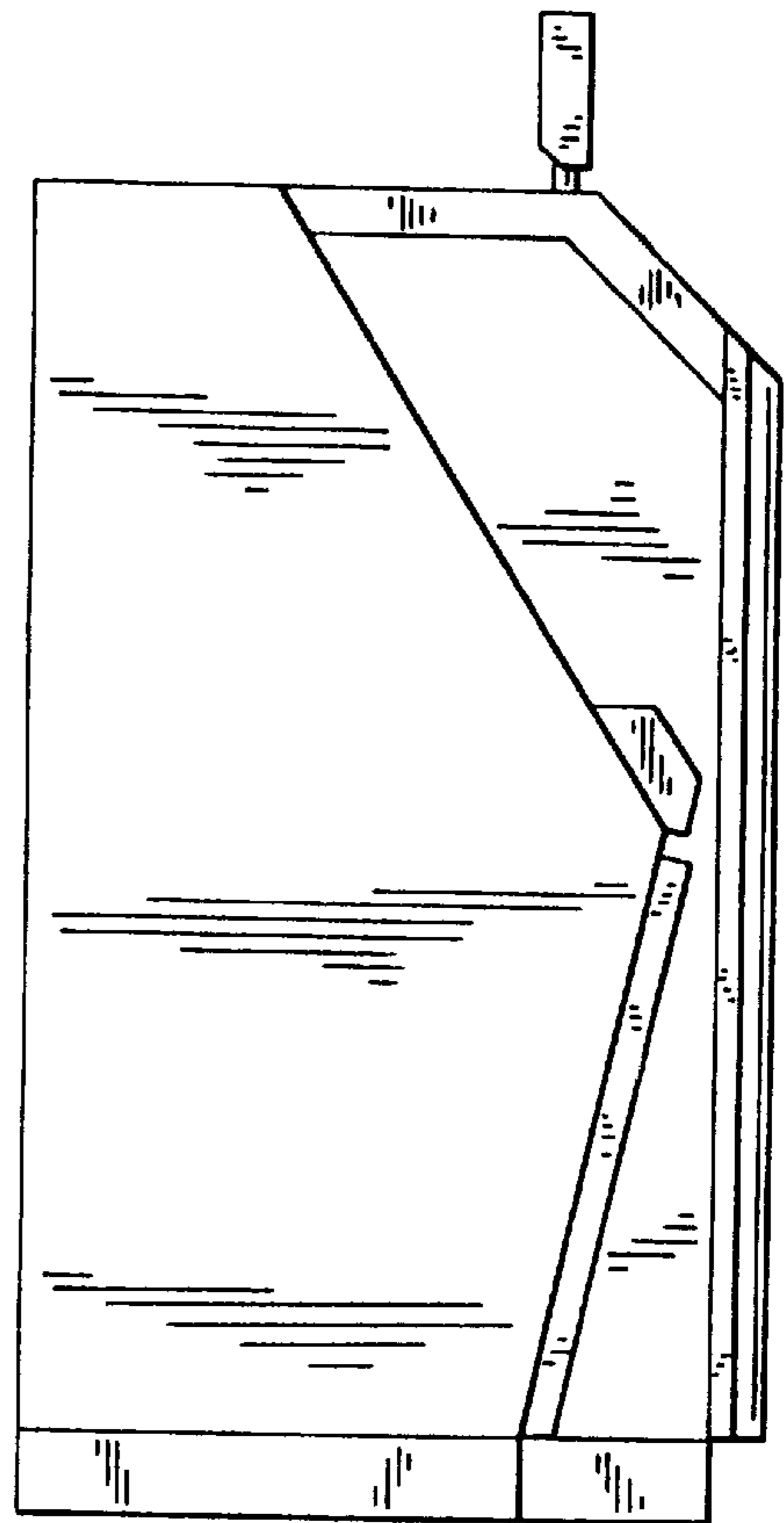

FIG. 9

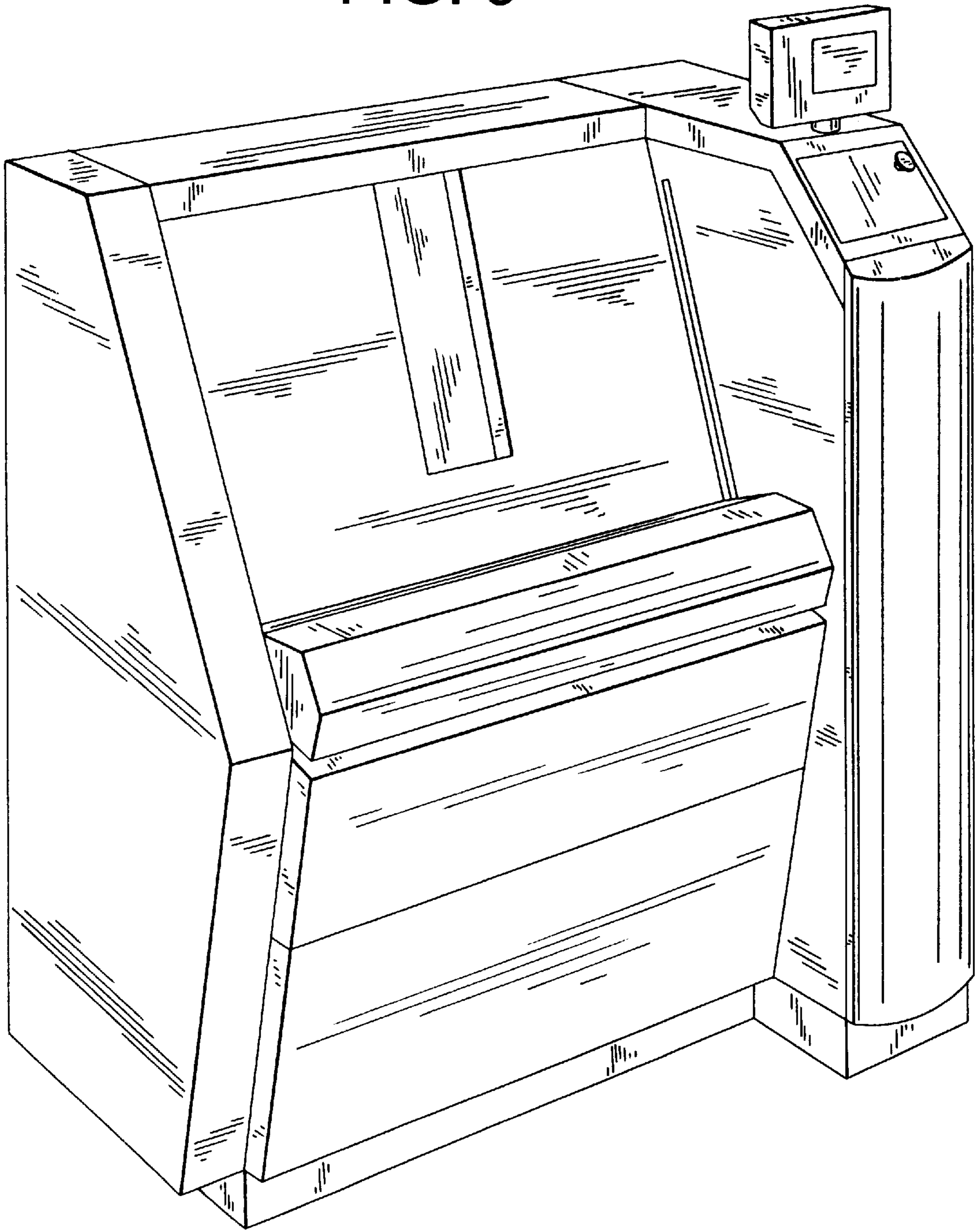

FIG. 10

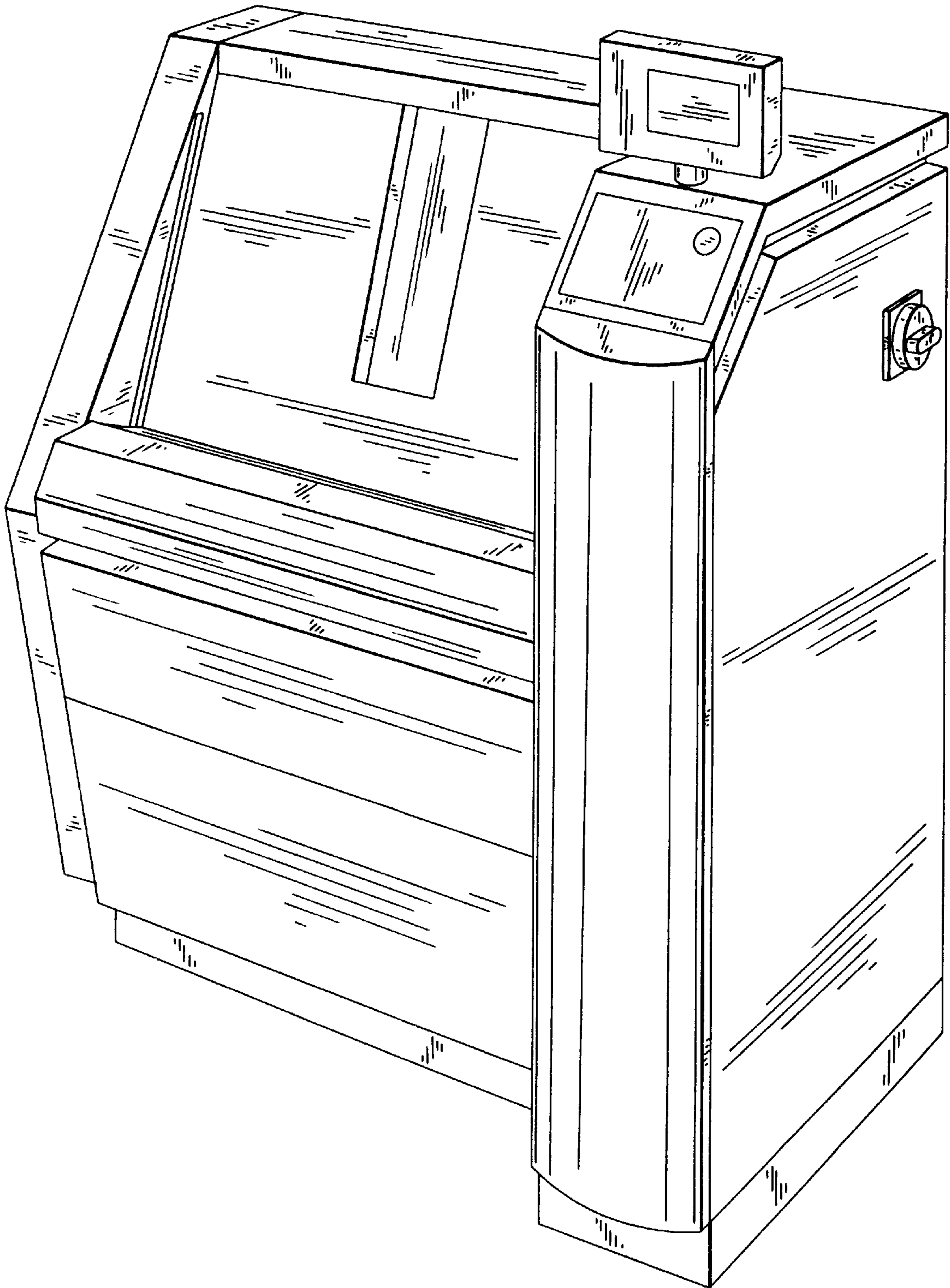

FIG. 11

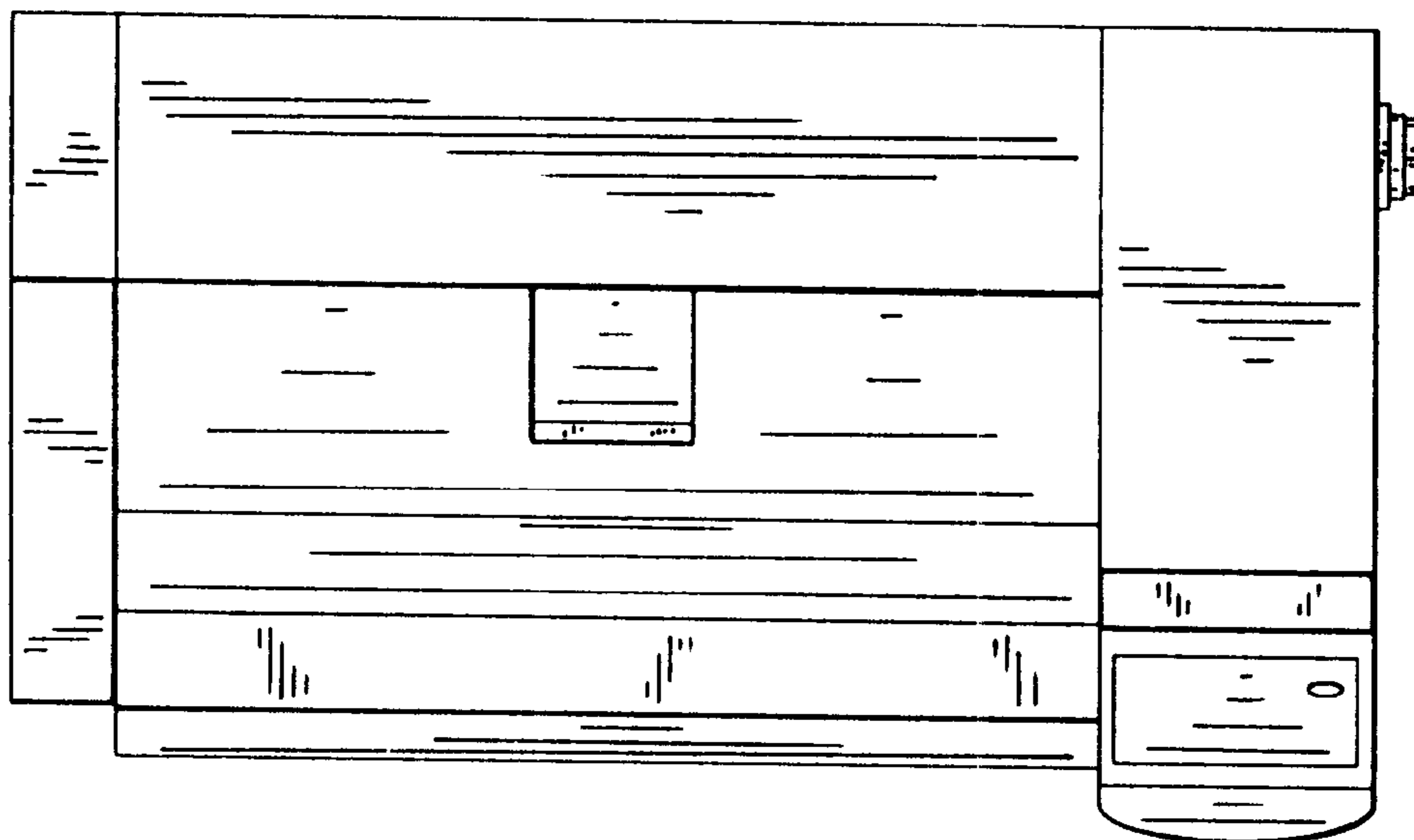

FIG. 16

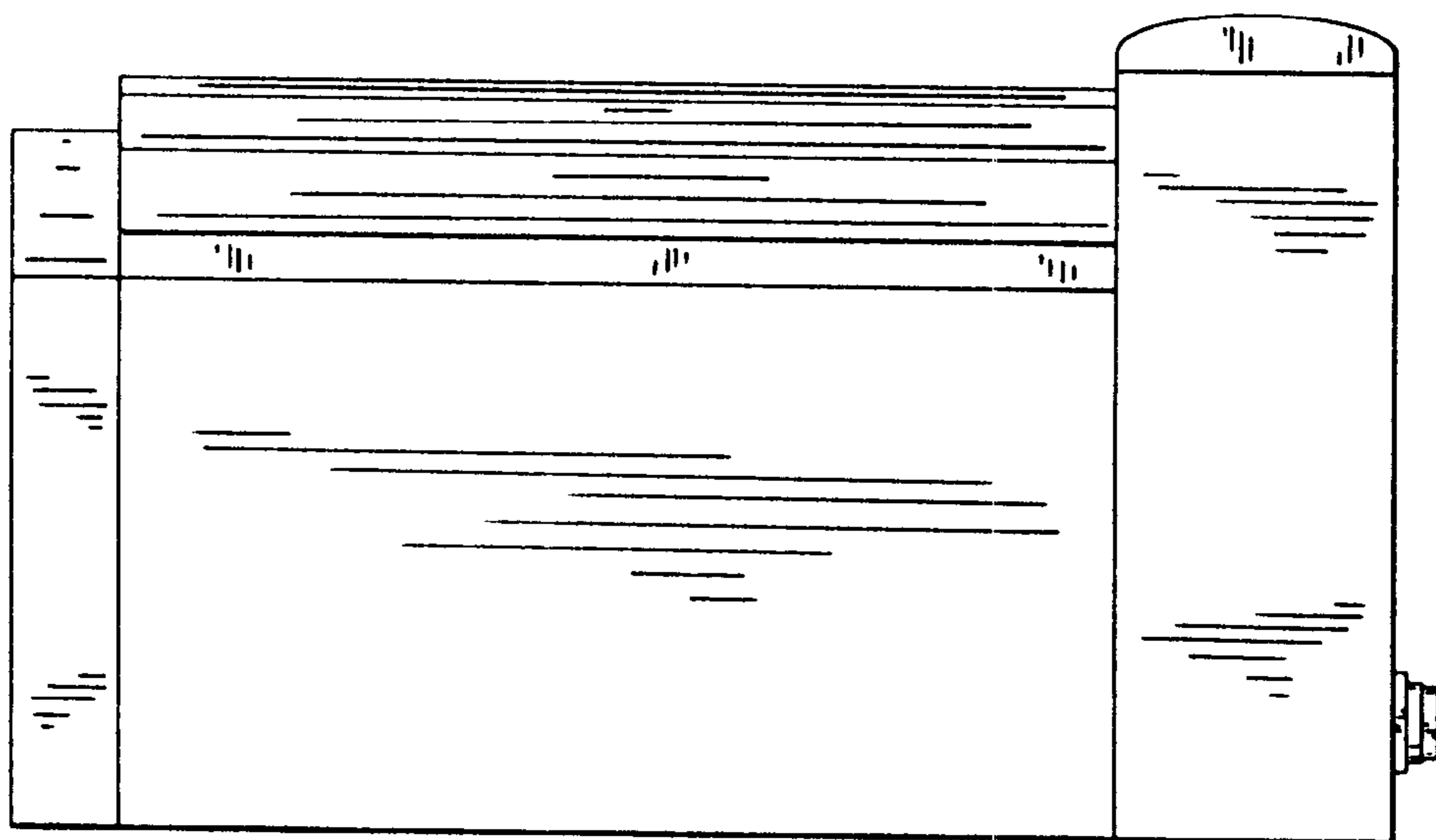

FIG. 12

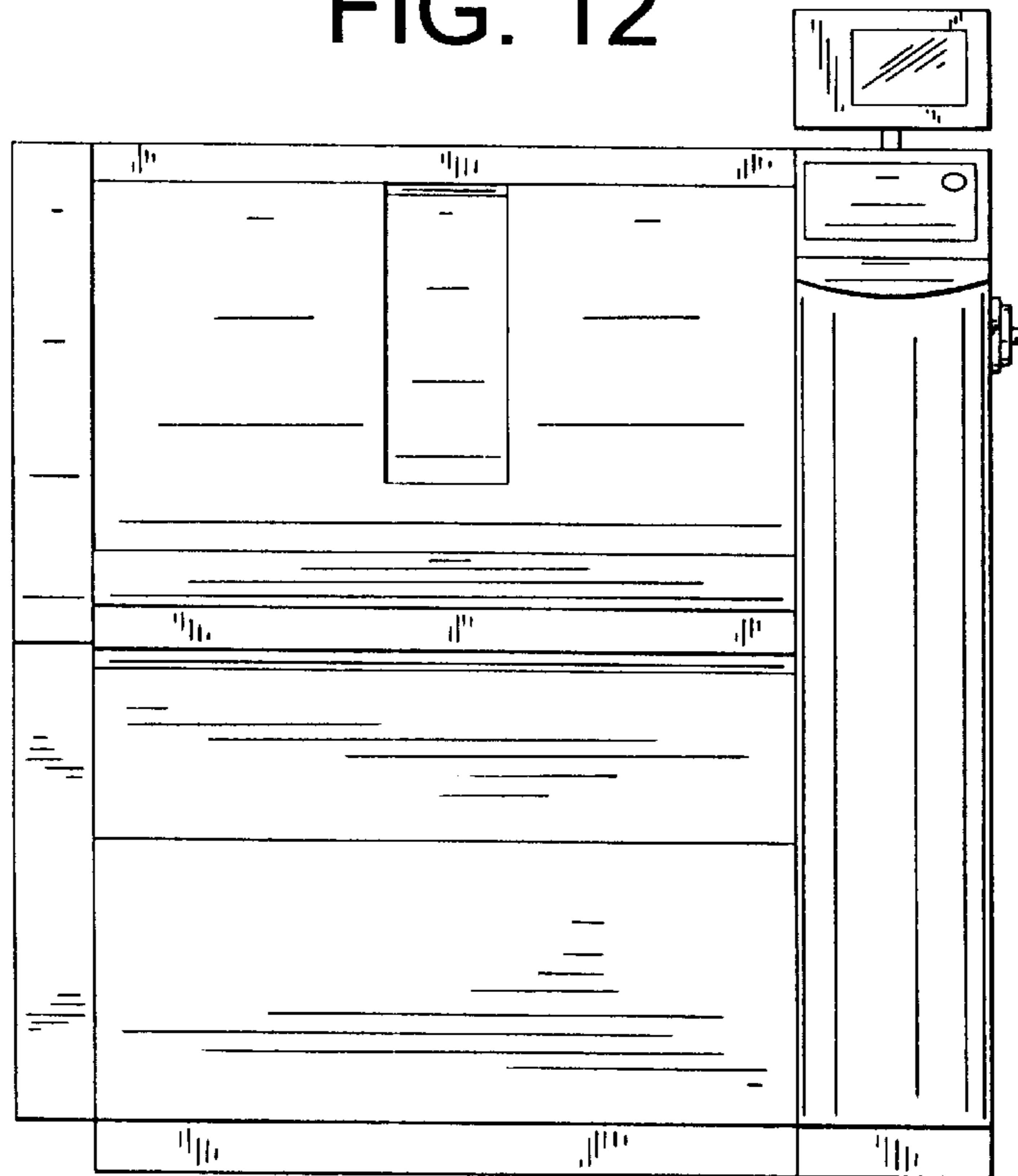

FIG. 14

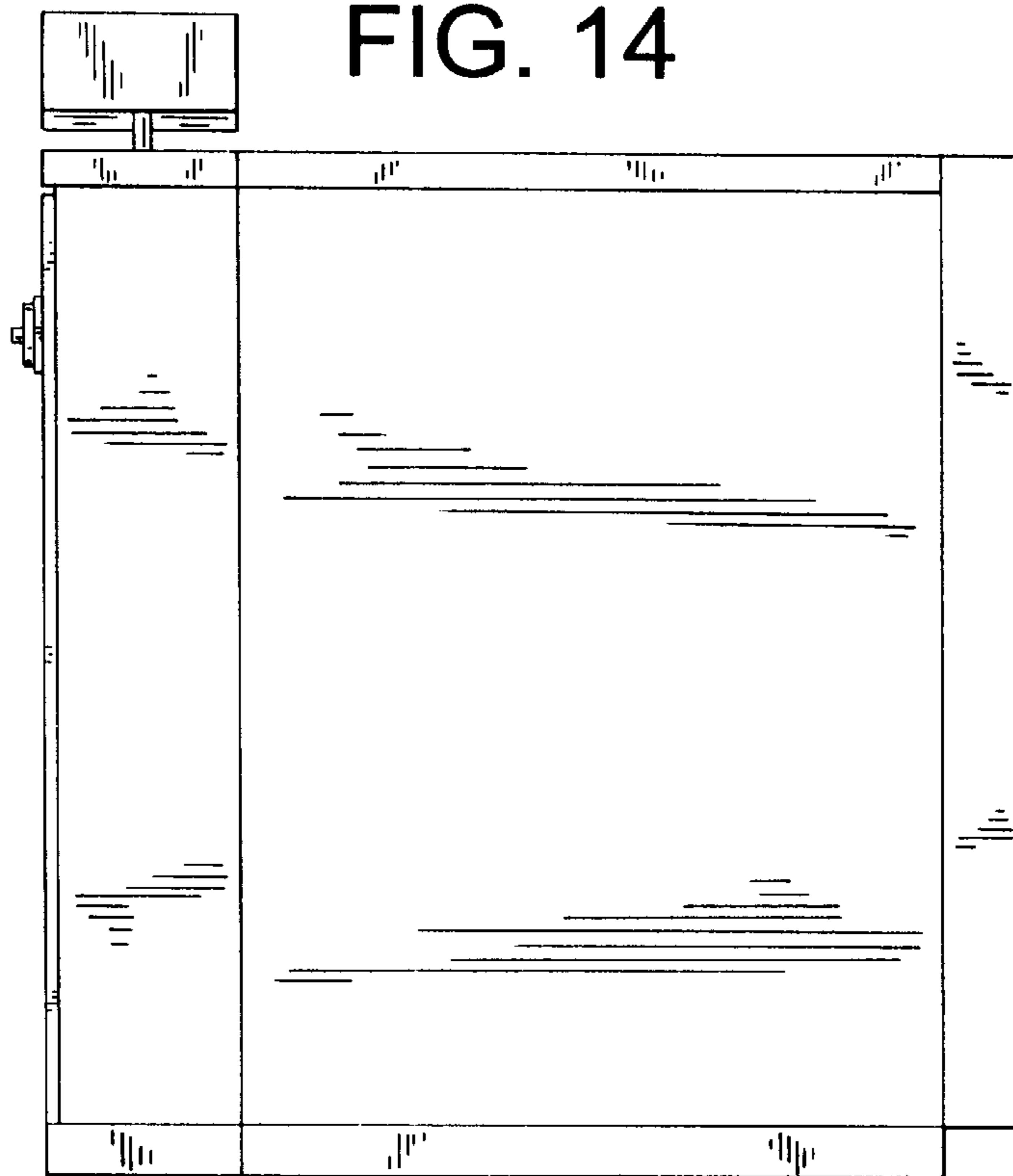

FIG. 13

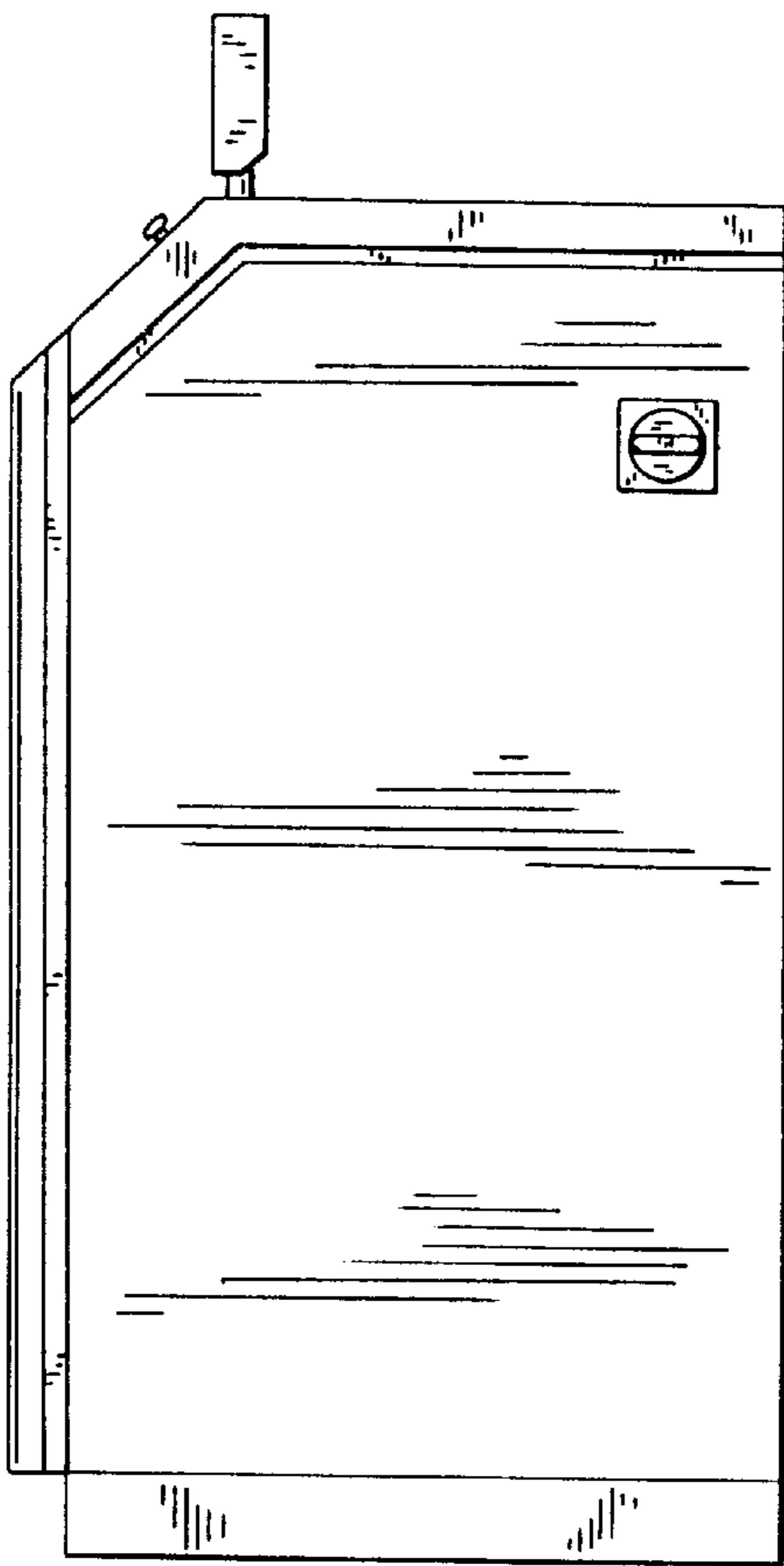

FIG. 15

