



US00D419891S

# United States Patent [19] Chan

[11] **Patent Number: Des. 419,891**  
[45] **Date of Patent: \*\* Feb. 1, 2000**

[54] **CLOCK WITH LIGHT**

[75] Inventor: **Sik-Leung Chan**, Tsuen Wan, The Hong Kong Special Administrative Region of the People's Republic of China

[73] Assignee: **C.C. & L Company Limited**, The Hong Kong Special Administrative Region of the People's Republic of China

[\*\*] Term: **14 Years**

[21] Appl. No.: **29/103,821**

[22] Filed: **Apr. 22, 1999**

[51] **LOC (7) Cl.** ..... **10-01**

[52] **U.S. Cl.** ..... **D10/5; D10/2; D10/15; D26/38**

[58] **Field of Search** ..... D10/5, 1-2, 15; 368/285, 10, 28-30, 239-242, 82-84, 41-44; D26/38, 42; 362/253

[56] **References Cited**

**U.S. PATENT DOCUMENTS**

- D. 312,220 11/1990 Kaneko ..... D10/5
- D. 314,245 1/1991 Brunschot ..... D26/54

- D. 348,009 6/1994 Lai ..... D10/15
- D. 354,921 1/1995 Narayanan ..... D10/78
- D. 380,567 7/1997 Hon ..... D26/38
- D. 383,071 9/1997 Suzuki ..... D10/5
- D. 388,713 1/1998 Yuen ..... D10/5
- D. 389,747 1/1998 Ramos et al. .... D10/30
- D. 393,597 4/1998 Pail ..... D10/30
- D. 396,193 7/1998 Pail ..... D10/30
- D. 407,065 3/1999 Chang ..... D13/110
- 5,578,997 11/1996 Harding ..... 340/574

*Primary Examiner*—Nelson C. Holtje  
*Attorney, Agent, or Firm*—Samuels, Gauthier & Stevens

[57] **CLAIM**

The ornamental design for a “clock with light”, as shown and described.

**DESCRIPTION**

FIG. 1 is the front perspective view showing my new design; FIG. 2 is the front view thereof; FIG. 3 is the rear view thereof; FIG. 4 is the left-hand view thereof; FIG. 5 is the right-hand view thereof; FIG. 6 is the top view thereof; FIG. 7 is the bottom view thereof; and, FIG. 8 is the front perspective view with cover open thereof.

**1 Claim, 4 Drawing Sheets**

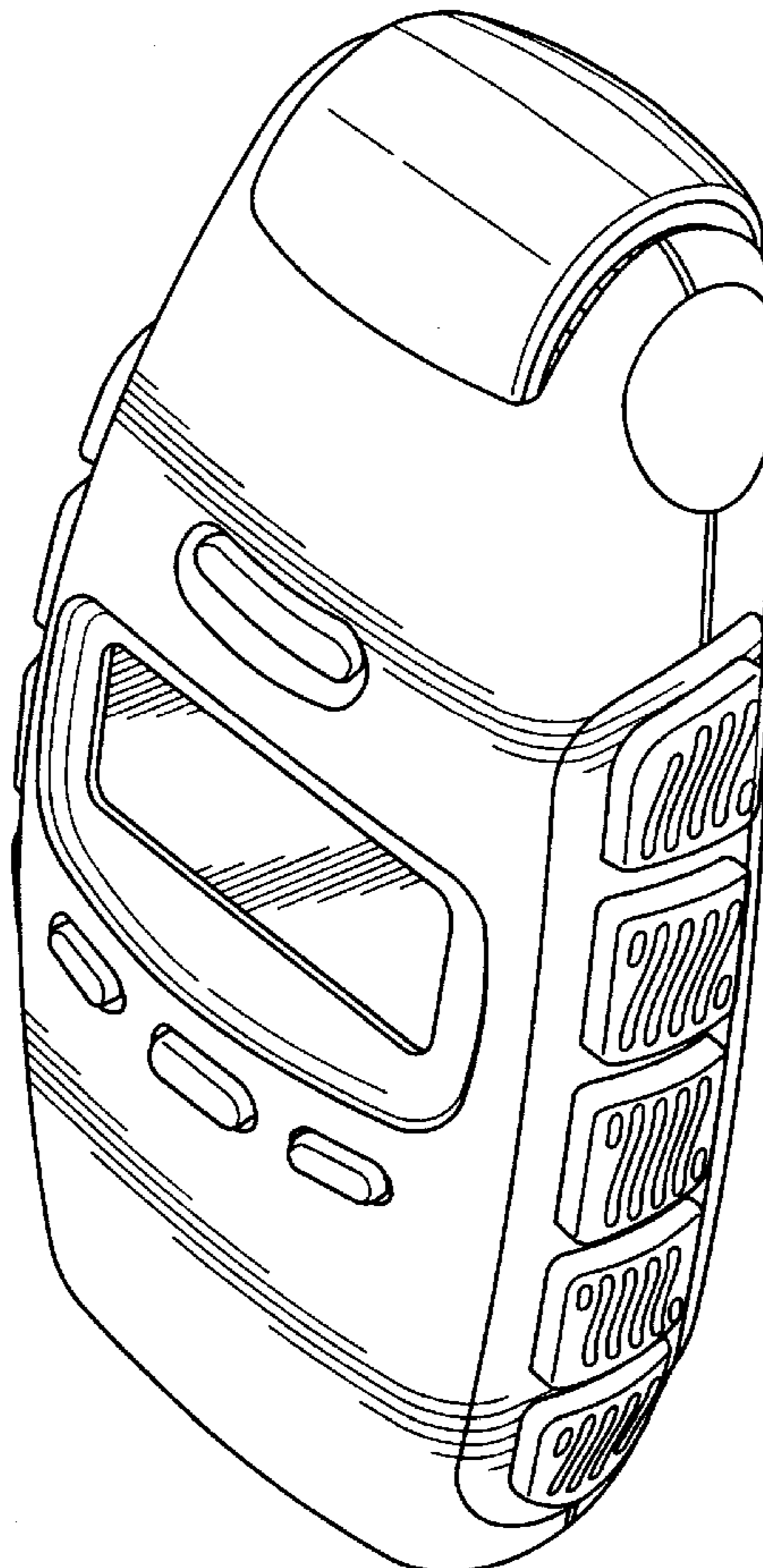

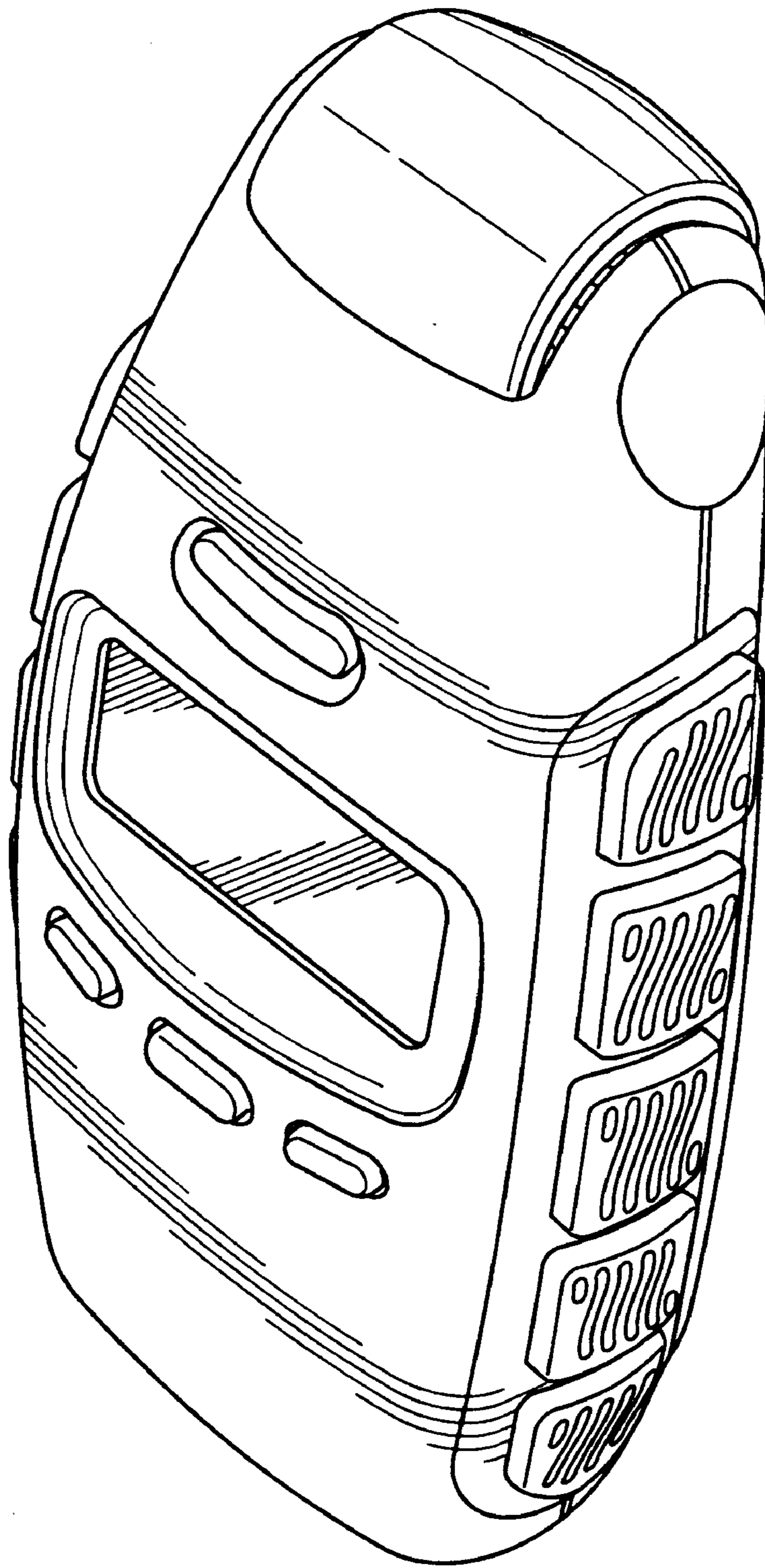

FIG. 1

FIG. 6

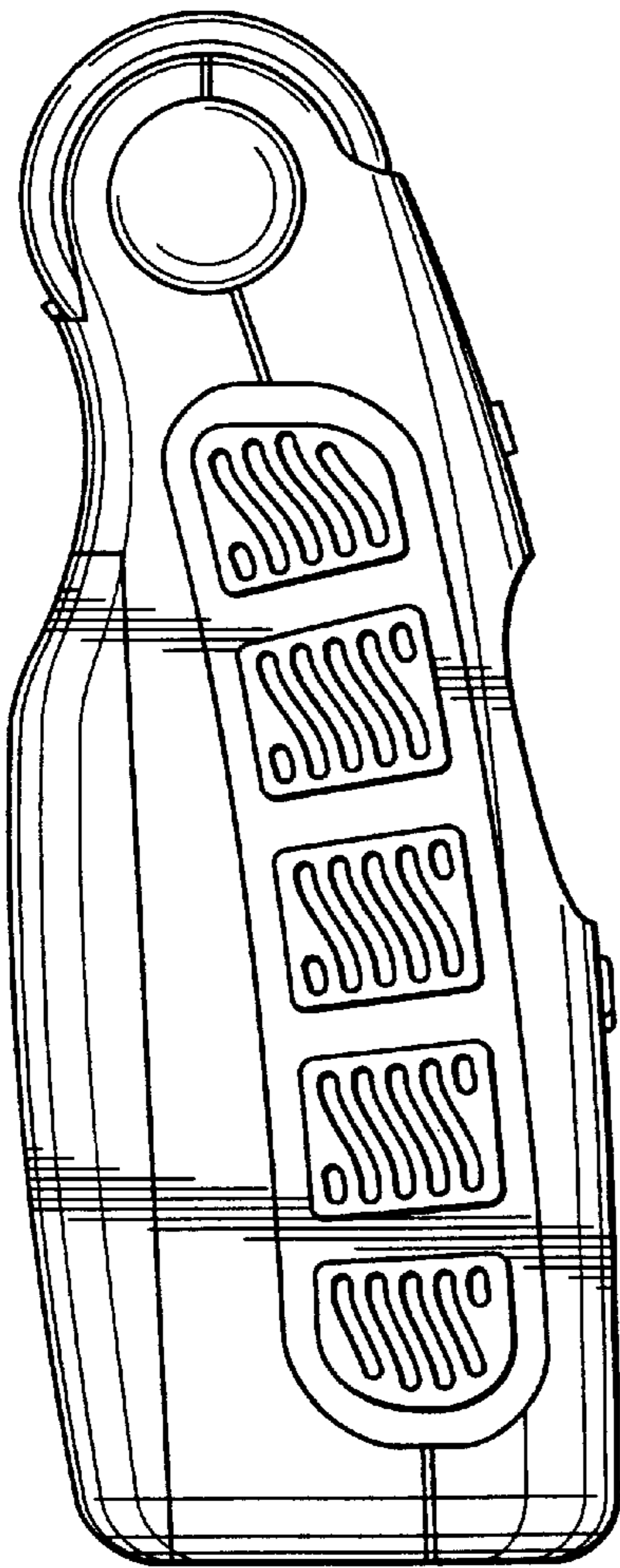
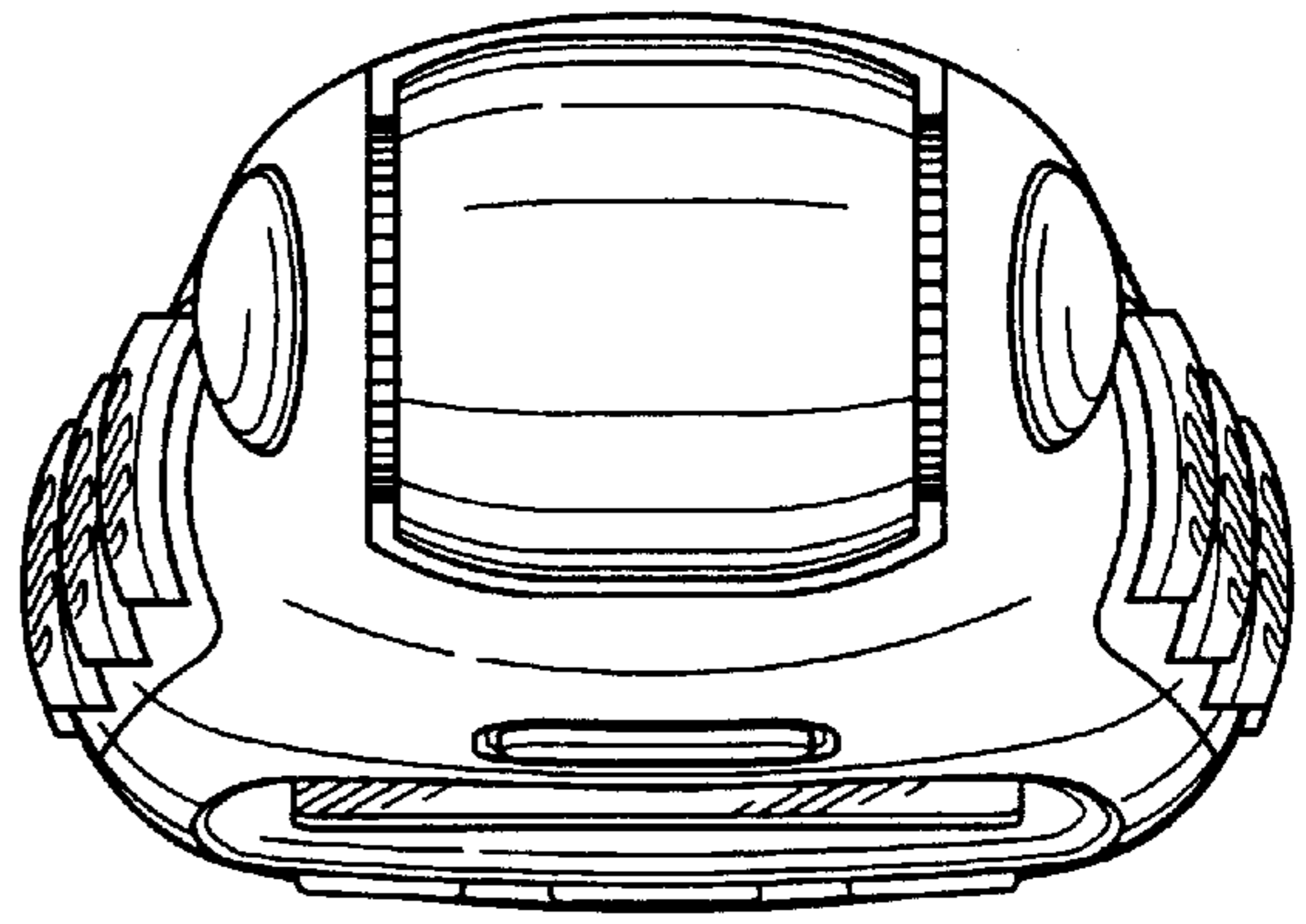

FIG. 4

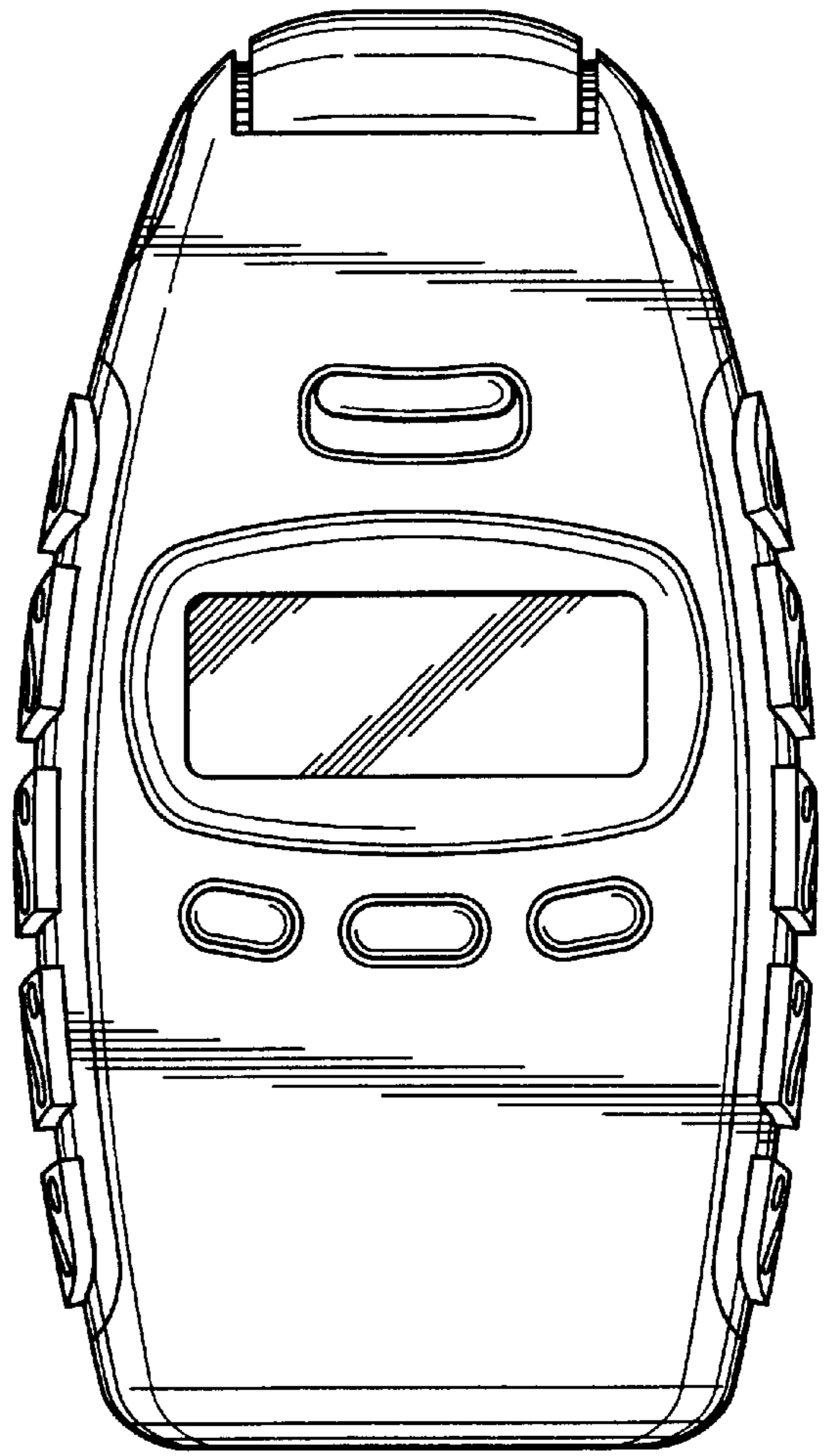

FIG. 2

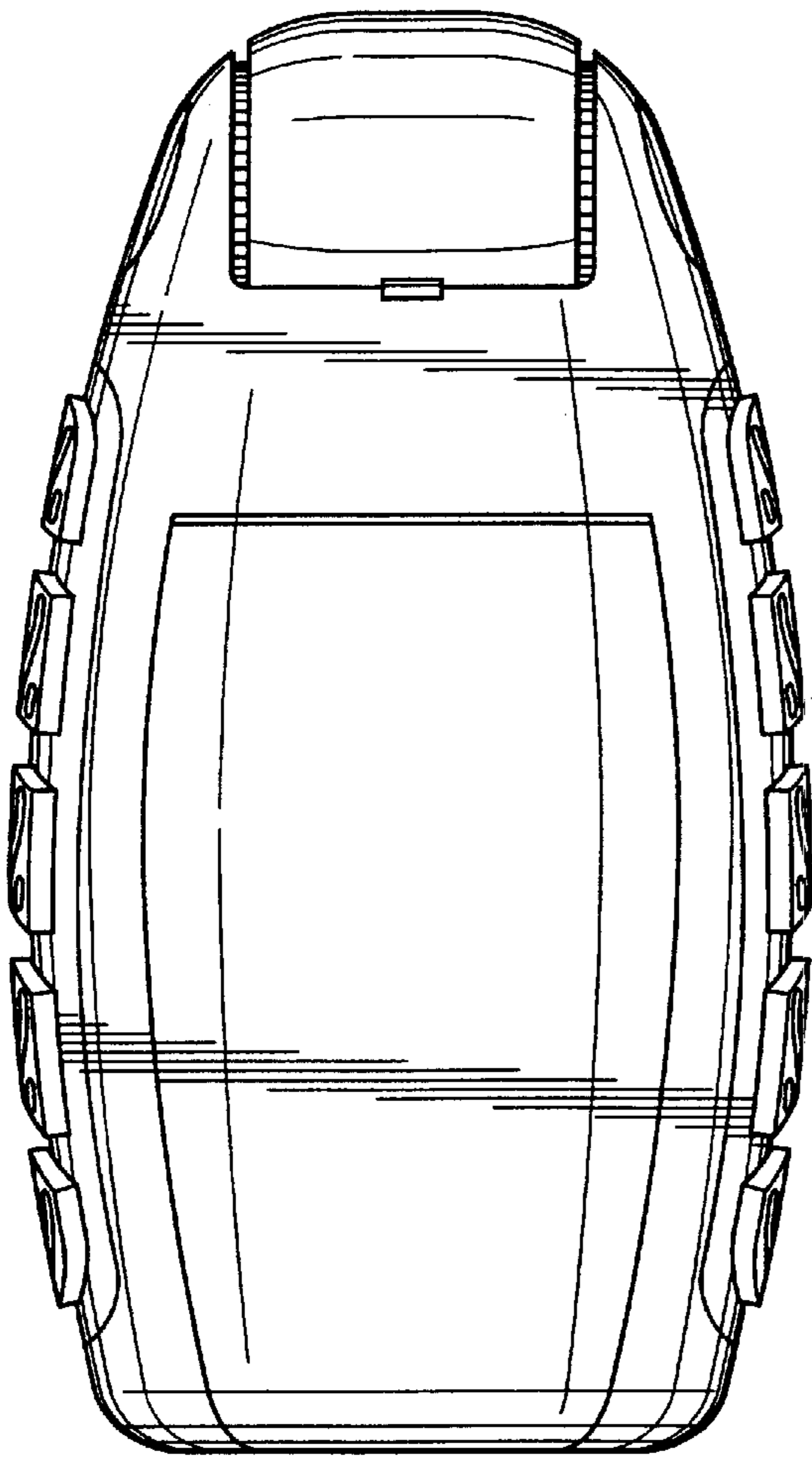

FIG. 3

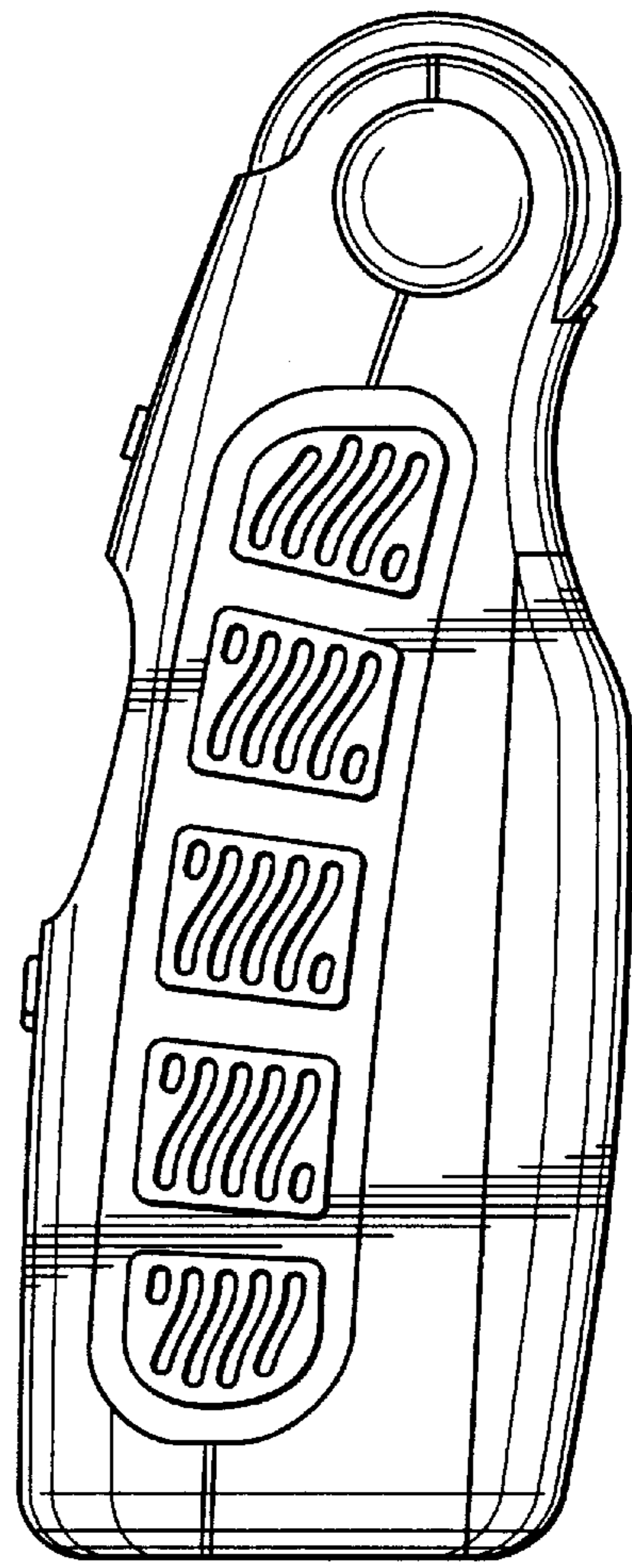

FIG. 5

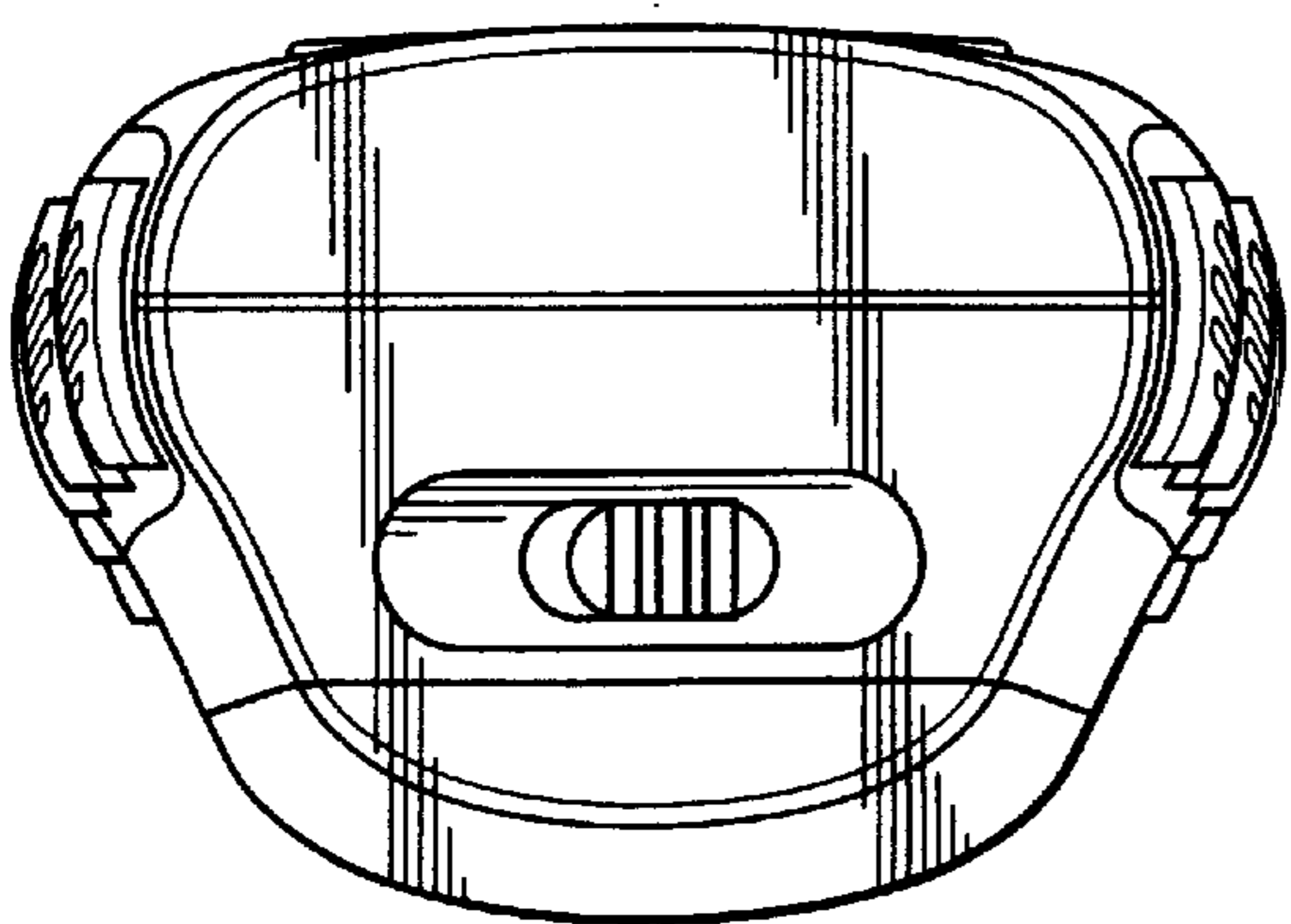

FIG. 7

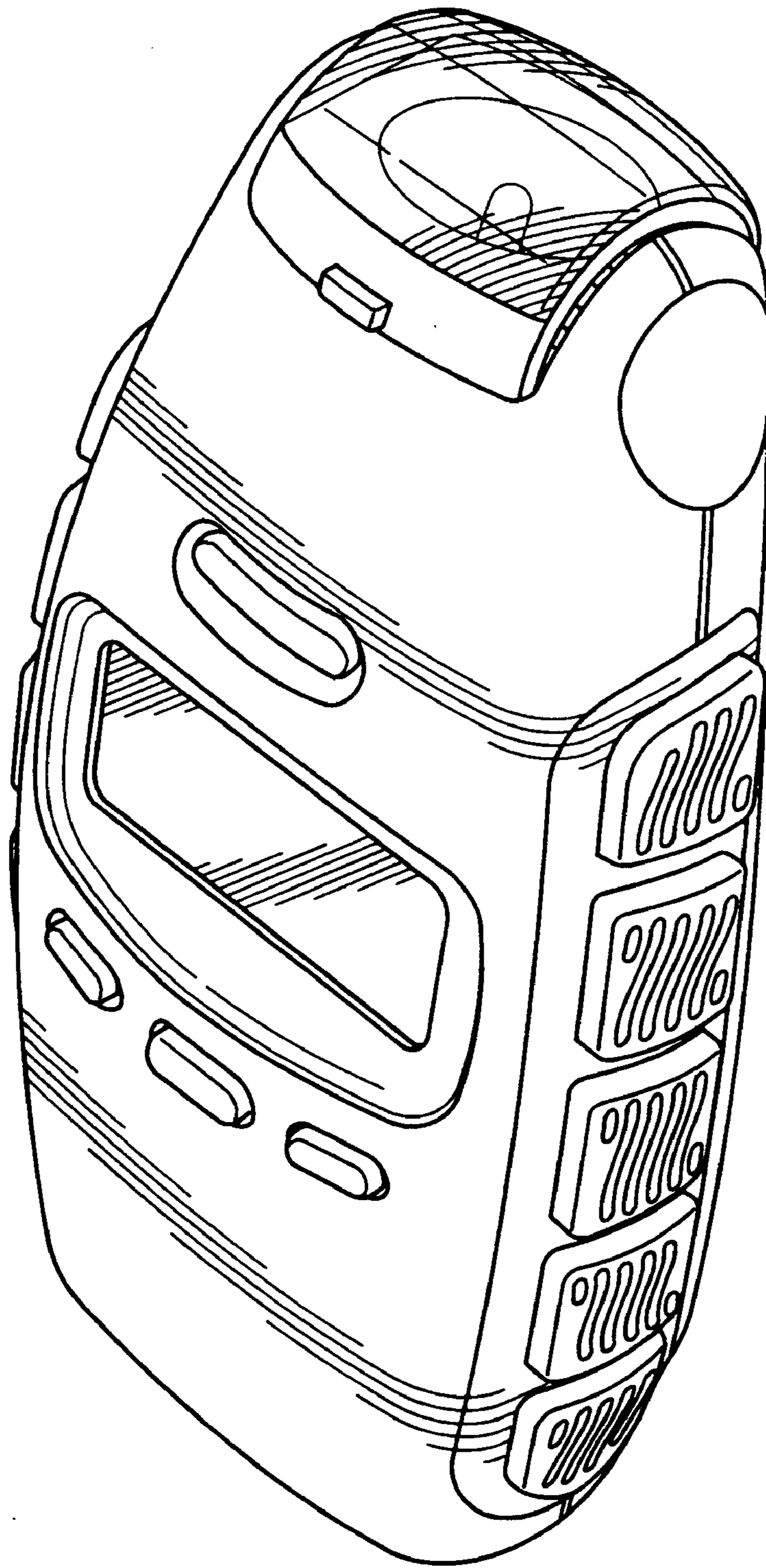

FIG. 8