



US00D419877S

United States Patent [19] Sayers

[11] **Patent Number: Des. 419,877**
[45] **Date of Patent: ** Feb. 1, 2000**

[54] **LIQUID DISPENSER**

[75] Inventor: **Richard C. Sayers**, Perrysburg, Ohio

[73] Assignee: **Owens-Illinois Closure Inc.**, Toledo, Ohio

[**] Term: **14 Years**

[21] Appl. No.: **29/097,273**

[22] Filed: **Dec. 3, 1998**

[51] **LOC (7) Cl.** **09-07**

[52] **U.S. Cl.** **D9/448**

[58] **Field of Search** D9/300, 435, 440, D9/447, 448, 454; D7/321, 511; 222/251, 320, 321.1, 321.6, 321.7, 321.8, 321.9

[56] **References Cited**

U.S. PATENT DOCUMENTS

D. 173,430 11/1954 Hills D9/300 X
D. 177,796 5/1956 Collins .
D. 208,825 10/1967 Hutton .

(List continued on next page.)

FOREIGN PATENT DOCUMENTS

978911 12/1975 Canada 222/402.13
1399208 6/1964 France .
1444567 8/1965 France .
1542927 10/1967 France .

OTHER PUBLICATIONS

“Emballages” (1981)—p. 97.

Primary Examiner—Cathron B. Matta

[57] **CLAIM**

The ornamental design for a liquid dispenser, as shown and described.

DESCRIPTION

FIG. 1 is a perspective view of the liquid dispenser of the present invention;

FIG. 2 is a top plan view of the liquid dispenser;

FIG. 3 is a side elevational view of the liquid dispenser of the invention, the opposite side elevational view being a mirror image thereof;

FIG. 4 is a front elevational view of the liquid dispenser of FIGS. 1-3;

FIG. 5 is a rear elevational view of the liquid dispenser of FIGS. 1-4;

FIG. 6 is a perspective view of a liquid dispenser in accordance with a second embodiment of the invention;

FIG. 7 is a top plan view of the liquid dispenser illustrated in FIG. 6;

FIG. 8 is a side elevational view of the liquid dispenser of FIGS. 6-7, the opposite side elevational view being a mirror image thereof;

FIG. 9 is a front elevational view of the liquid dispenser illustrated in FIGS. 6-8;

FIG. 10 is a rear elevational view of the liquid dispenser illustrated in FIGS. 6-9;

FIG. 11 is a perspective view of a liquid dispenser in accordance with a third embodiment of the invention;

FIG. 12 is a top plan view of the liquid dispenser illustrated in FIG. 11;

FIG. 13 is a side elevational view of the liquid dispenser illustrated in FIGS. 11-12, the opposite side elevational view being a mirror image thereof;

FIG. 14 is a front elevational view of the liquid dispenser illustrated in FIGS. 11-13;

FIG. 15 is a rear elevational view of the liquid dispenser illustrated in FIGS. 11-14;

FIG. 16 is a perspective view of a liquid dispenser in accordance with a fourth embodiment of the invention;

FIG. 17 is a top plan view of the liquid dispenser in FIG. 16;

FIG. 18 is a side elevational view of the liquid dispenser illustrated in FIGS. 16 and 17, the opposite side being a mirror image thereof;

FIG. 19 is a front elevational view of the liquid dispenser illustrated in FIGS. 16-18; and,

FIG. 20 is a rear elevational view of the liquid dispenser illustrated in FIGS. 16-19.

1 Claim, 4 Drawing Sheets

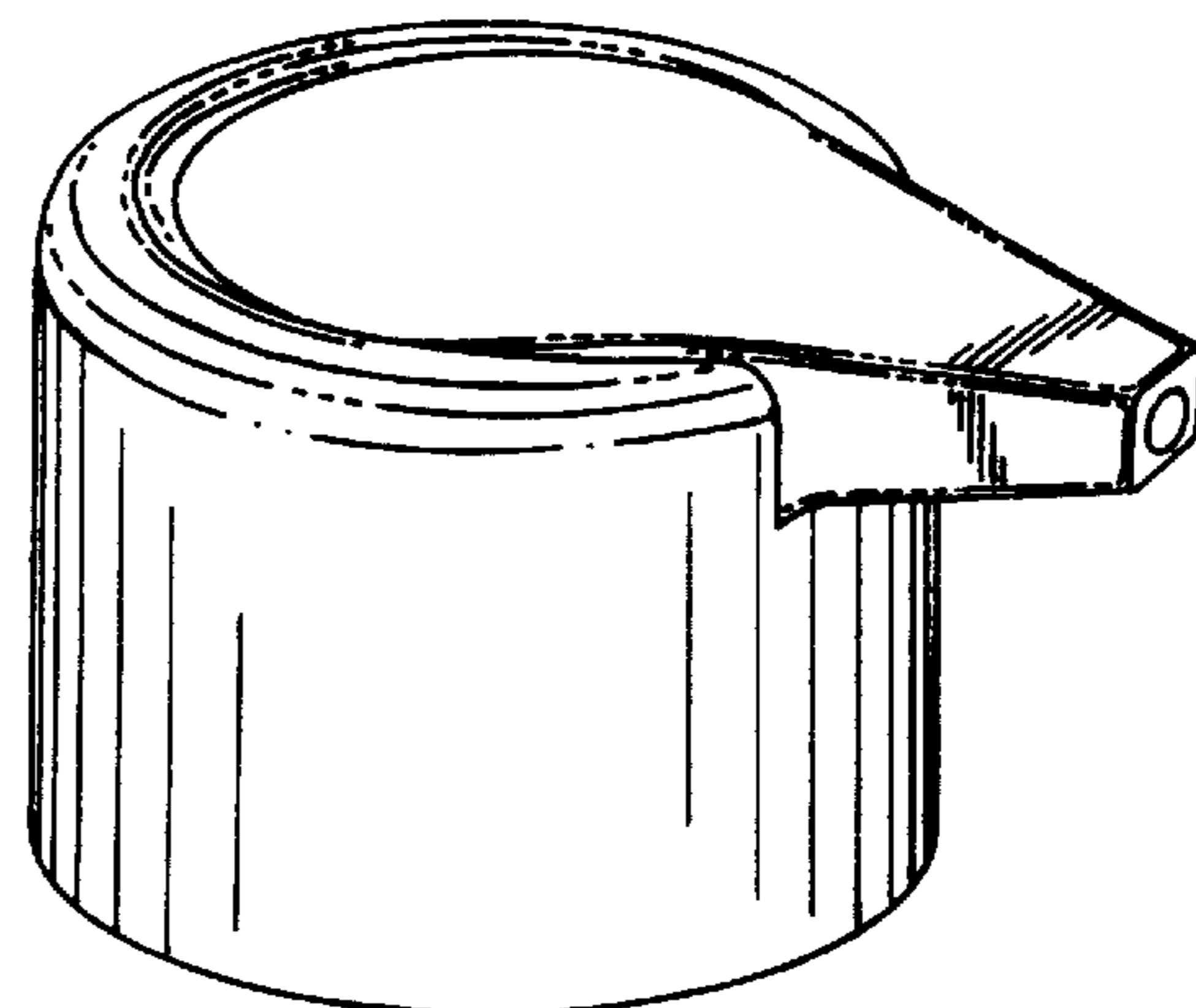
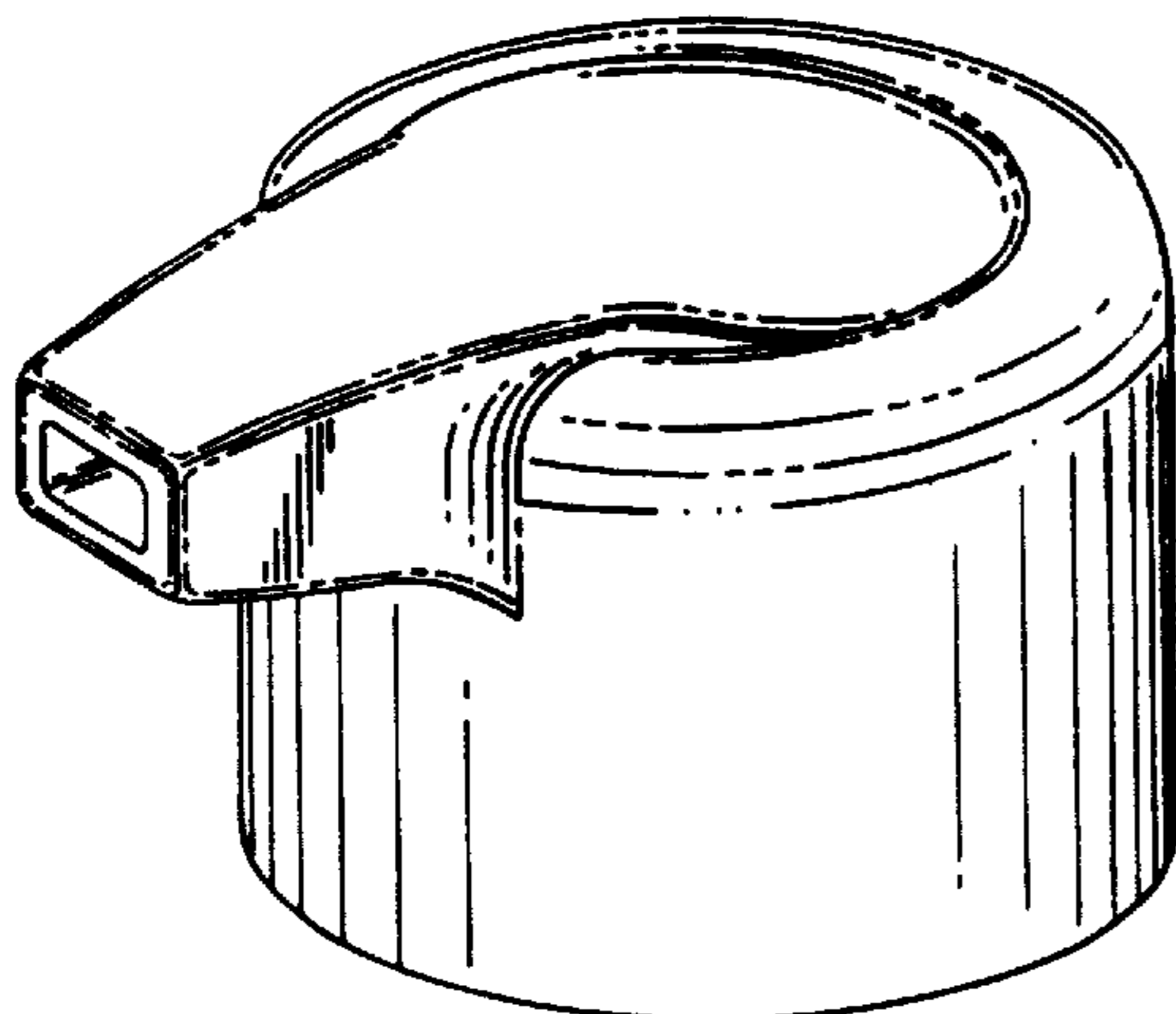

U.S. PATENT DOCUMENTS					
			2,231,779	2/1941	Swartzel .
			2,998,165	8/1961	De Elorza .
			3,062,416	11/1962	Cooprider .
			3,146,920	9/1964	Benjamin .
			3,229,864	1/1966	Roder .
			3,323,695	6/1967	Monahon .
			3,724,726	4/1973	Susuki .
			3,759,426	9/1973	Kane .
			3,908,870	9/1975	Nozawa et al. .
			4,144,987	3/1979	Kishi .
			4,183,449	1/1980	Blake .
			4,368,830	1/1983	Soughers .
			4,371,099	2/1983	Foster et al. .
			4,462,549	7/1984	Saito et al. .
			4,511,065	4/1985	Corsette .
			4,516,727	5/1985	Saito et al. .
			4,591,076	5/1986	Iizuka .
			4,606,479	8/1986	Van Brocklin .
			4,817,829	4/1989	Fuchs et al. .
			4,889,262	12/1989	Toms .
			5,088,629	2/1992	O'Neill .
			5,092,495	3/1992	Andre .
			5,163,588	11/1992	Cater .
			5,234,135	8/1993	LaFosse et al. .
			5,301,852	4/1994	Mancini .
			5,326,000	7/1994	Fuchs .
			5,335,830	8/1994	Cater .
			5,348,189	9/1994	Cater .
			5,388,730	2/1995	Abbott et al. .
			5,388,766	2/1995	Buisson .
			5,449,094	9/1995	Behar et al. .
D. 218,553	9/1970	Nigro .			
D. 219,124	11/1970	Gortz et al. .			
D. 219,125	11/1970	Gortz et al. .			
D. 224,508	8/1972	Newby .			
D. 234,342	2/1975	Schick .			
D. 244,513	5/1977	Butcher .			
D. 253,398	11/1979	Niemeyer et al. .			
D. 272,988	3/1984	Podall et al. .			
D. 275,933	10/1984	Topor et al. .			
D. 279,511	7/1985	Matsubara .			
D. 291,972	9/1987	Pfeiffer .			
D. 296,526	7/1988	von Schuckmann .			
D. 314,149	1/1991	Guilbert .			
D. 314,688	2/1991	Guillerm .			
D. 328,712	8/1992	Butler .			
D. 332,223	1/1993	Albertson .			
D. 338,616	8/1993	MacDonald et al. .			
D. 339,527	9/1993	Tobler .			
D. 347,385	5/1994	Kunesh .			
D. 349,045	7/1994	Schmitt .			
D. 351,794	10/1994	Foster .			
D. 355,845	2/1995	Wass .			
D. 356,947	4/1995	Mueller .			
D. 371,738	7/1996	Lamb .			
D. 381,909	8/1997	Sayers et al. D9/447			
D. 385,792	11/1997	Sayers et al. D9/448			
D. 396,188	7/1998	Sayers .			
1,756,279	4/1930	Campbell, Jr. .			
1,788,795	1/1931	Hoban .			
2,150,485	3/1939	Bernhardt .			

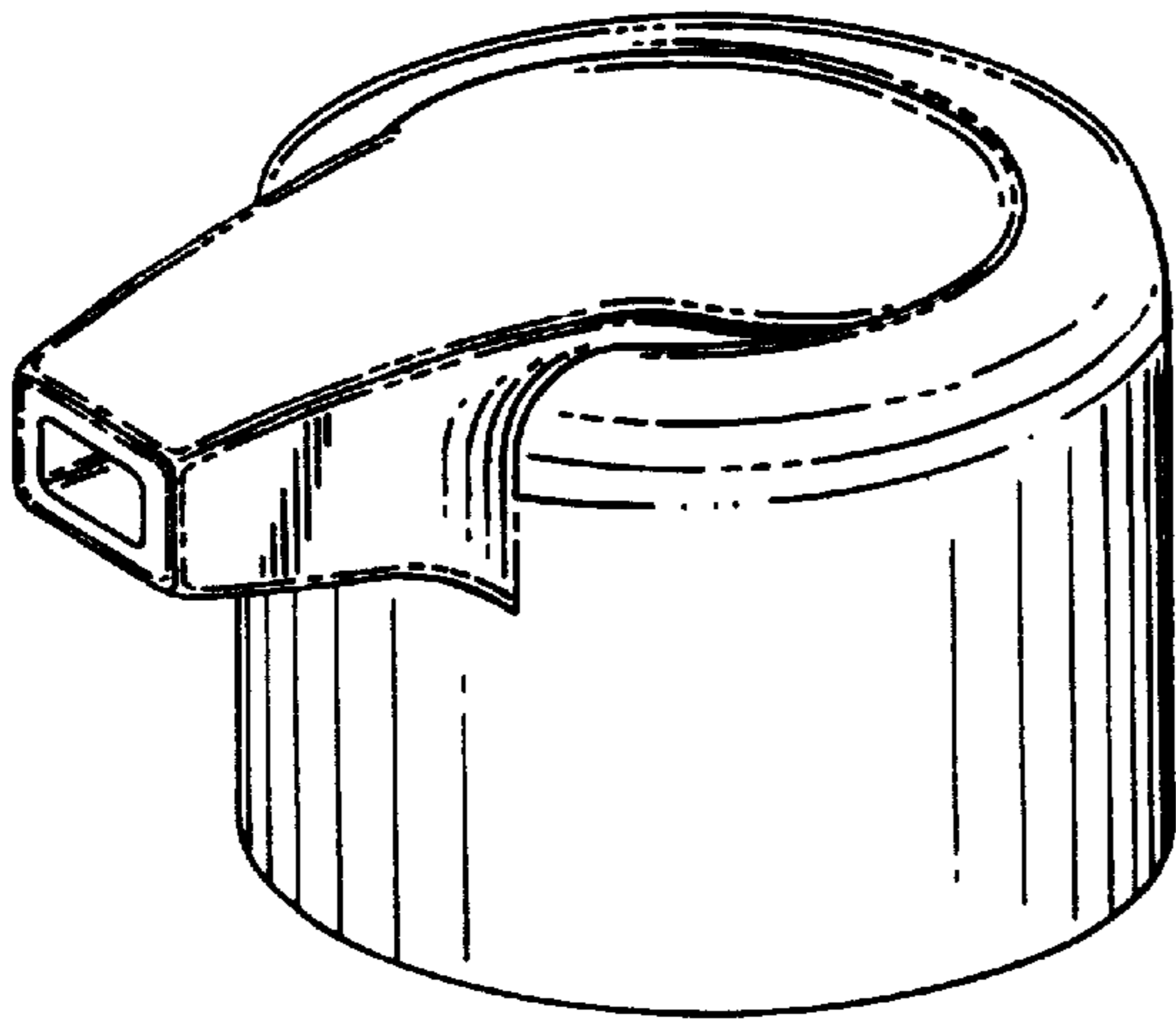

FIG. 1

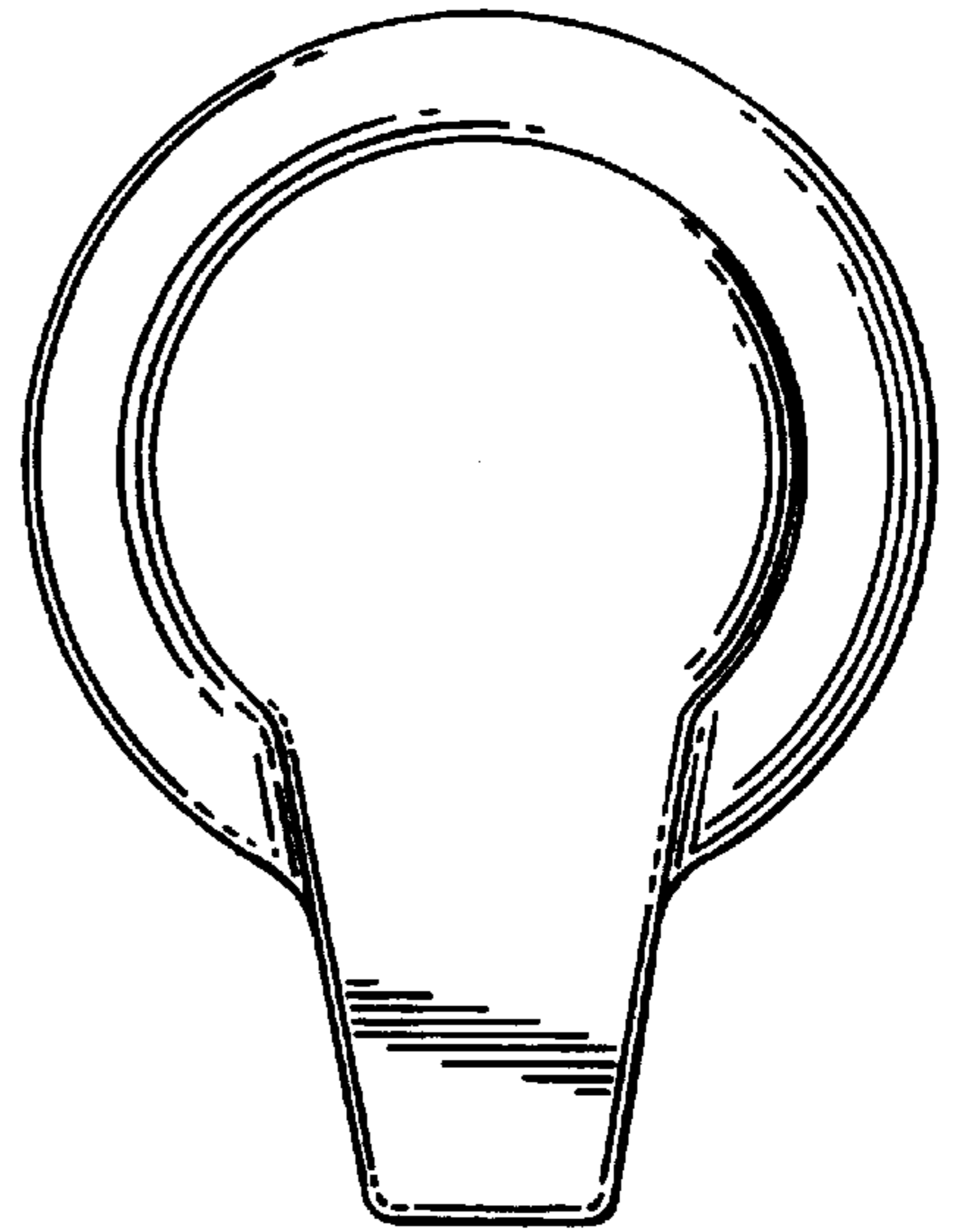

FIG. 2

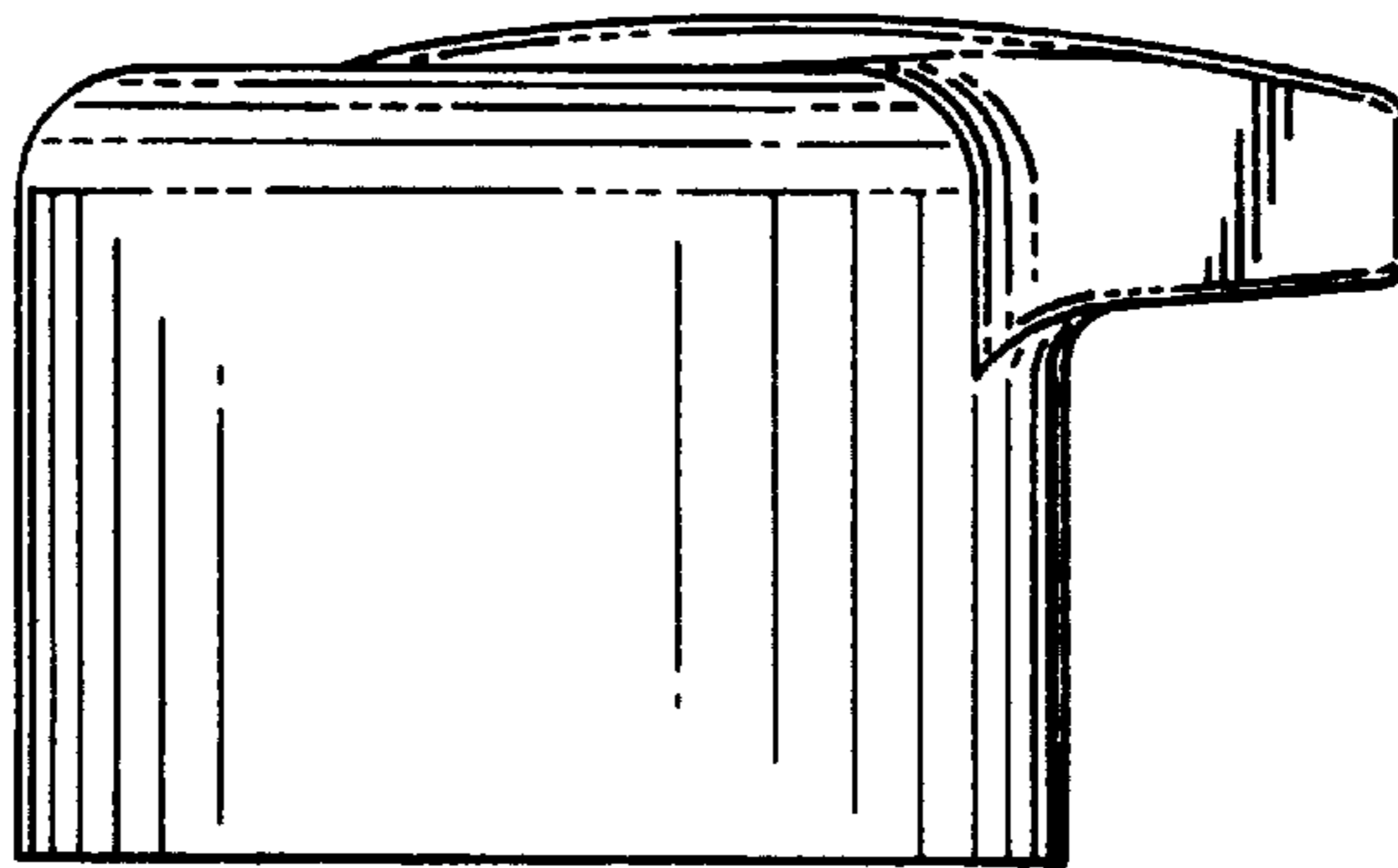

FIG. 3

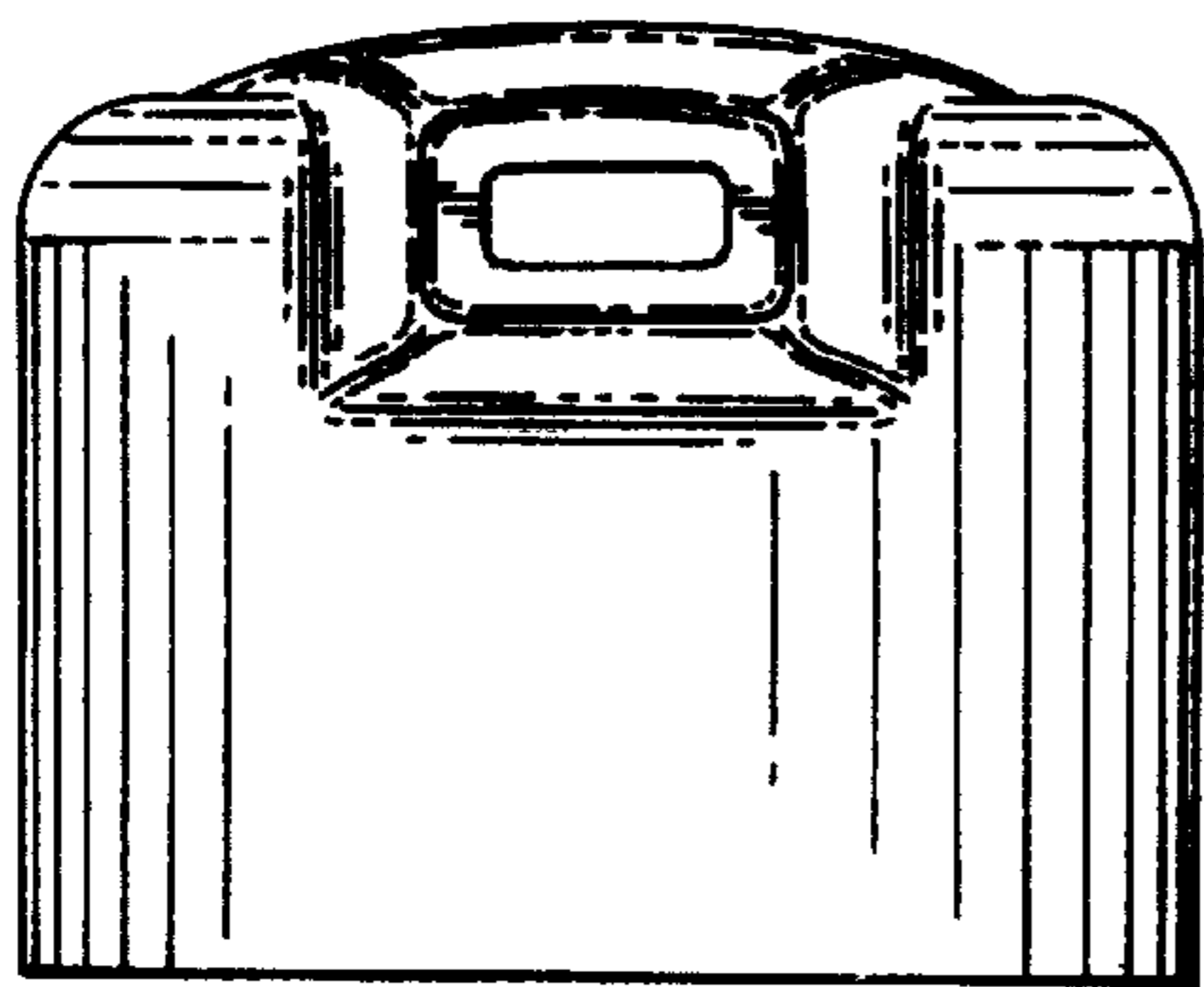

FIG. 4

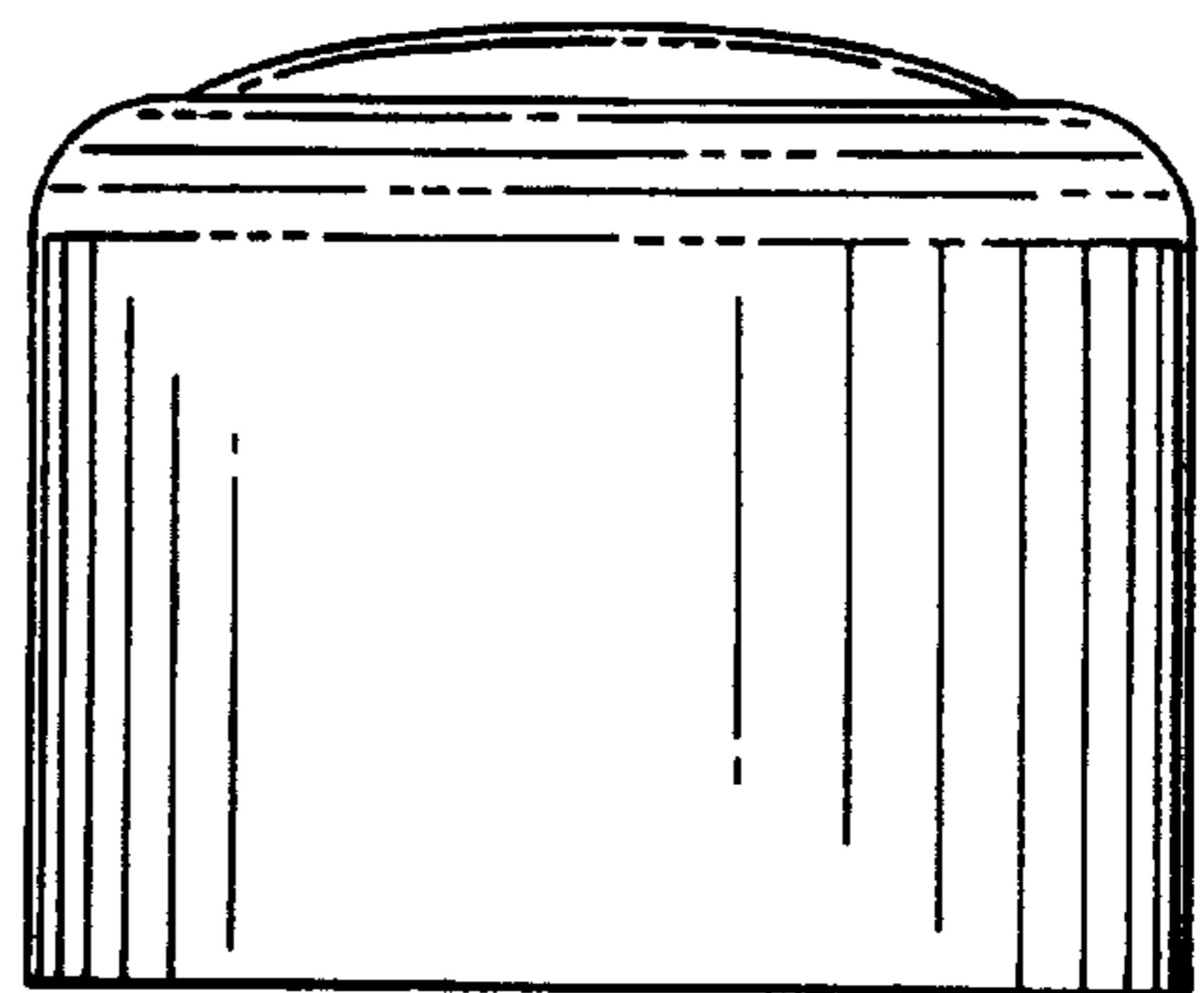

FIG. 5

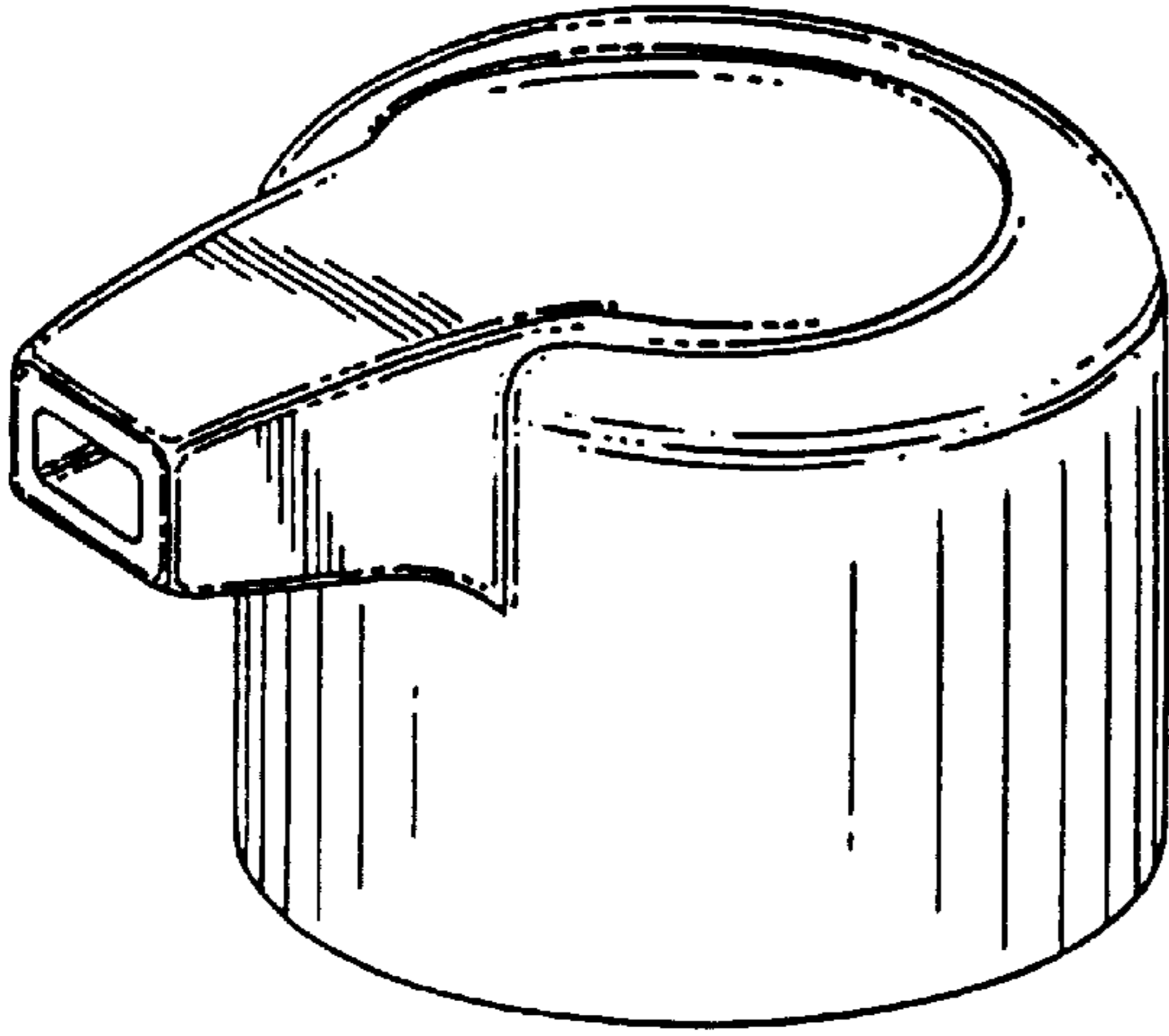

FIG. 6

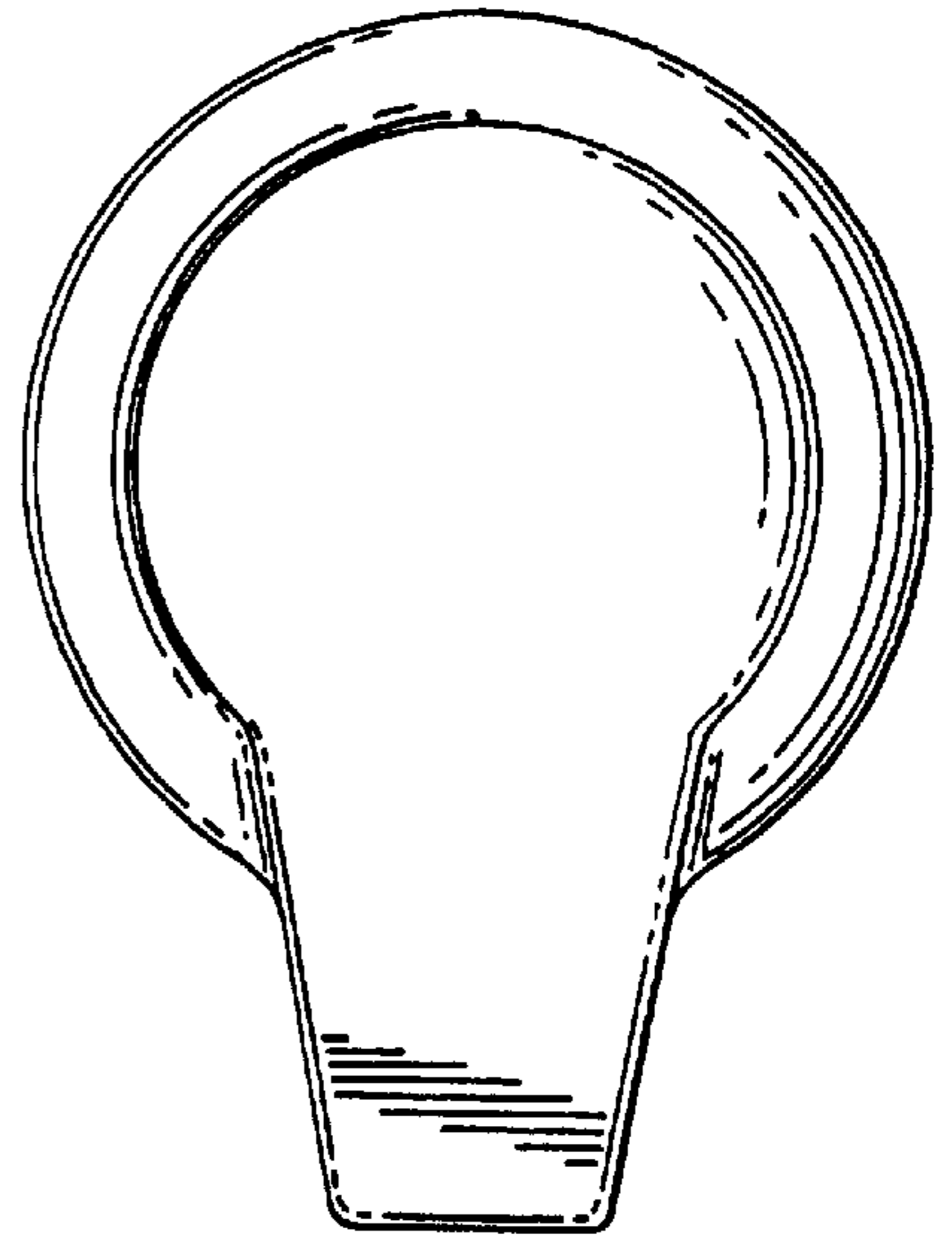

FIG. 7

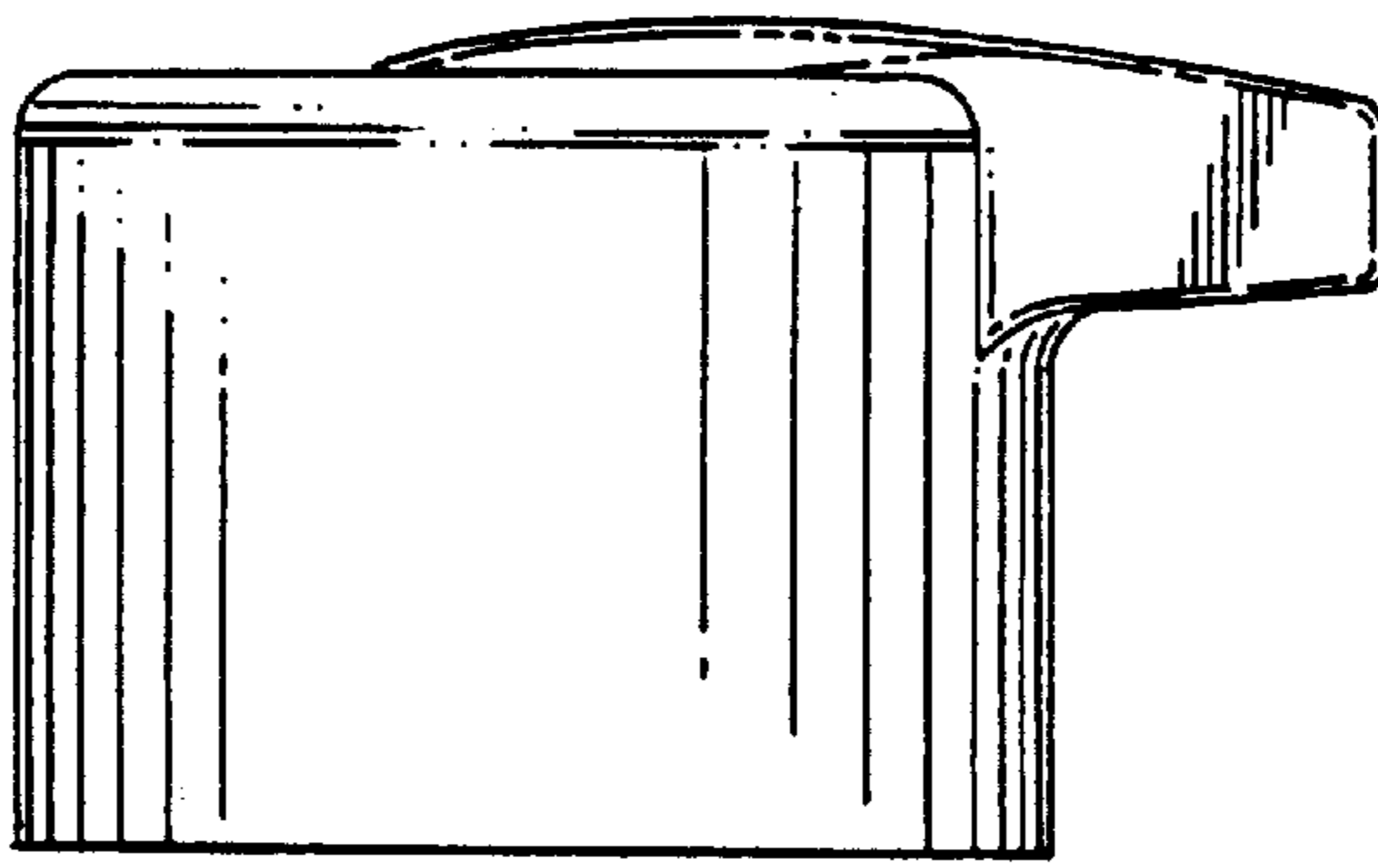

FIG. 8

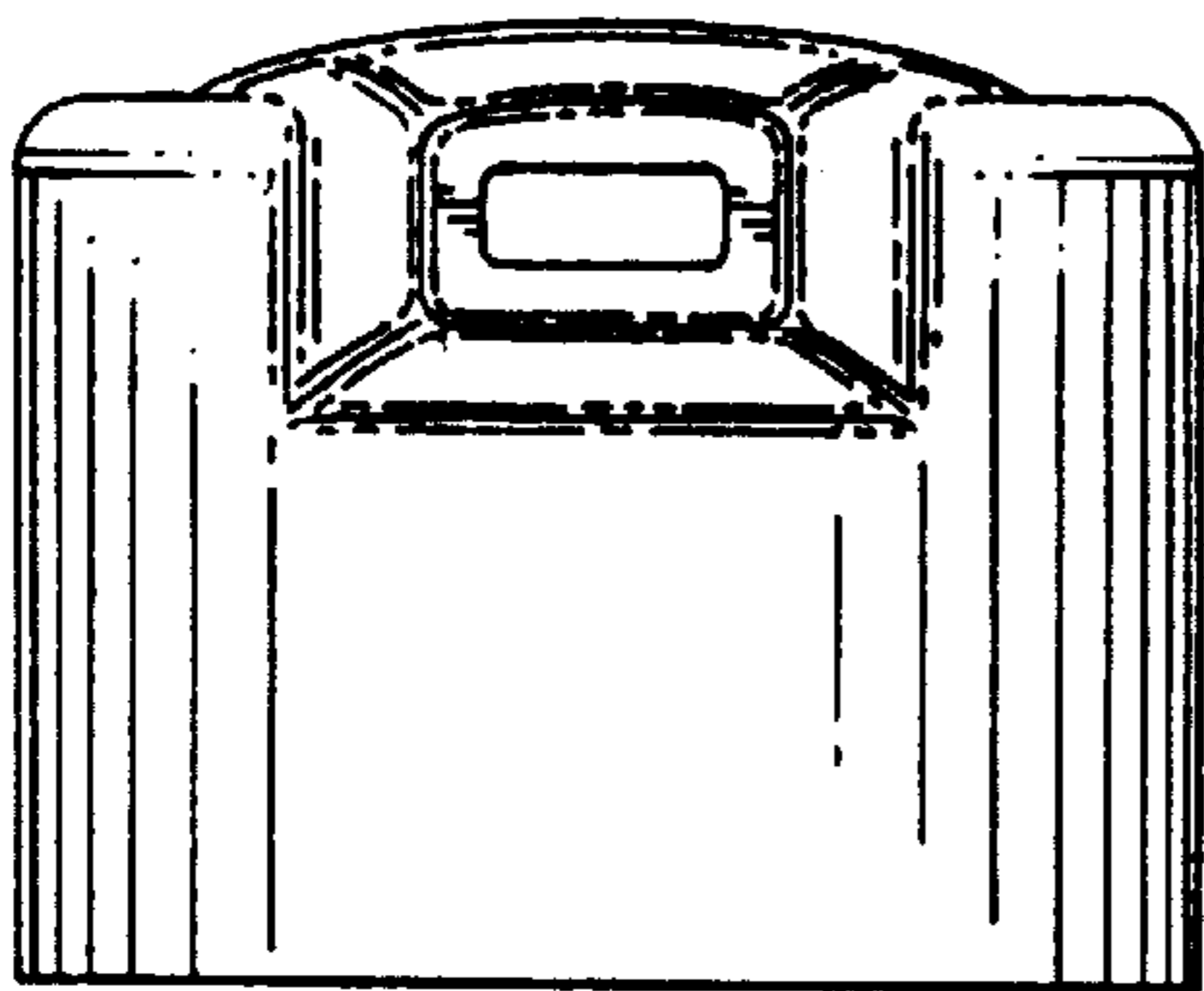

FIG. 9

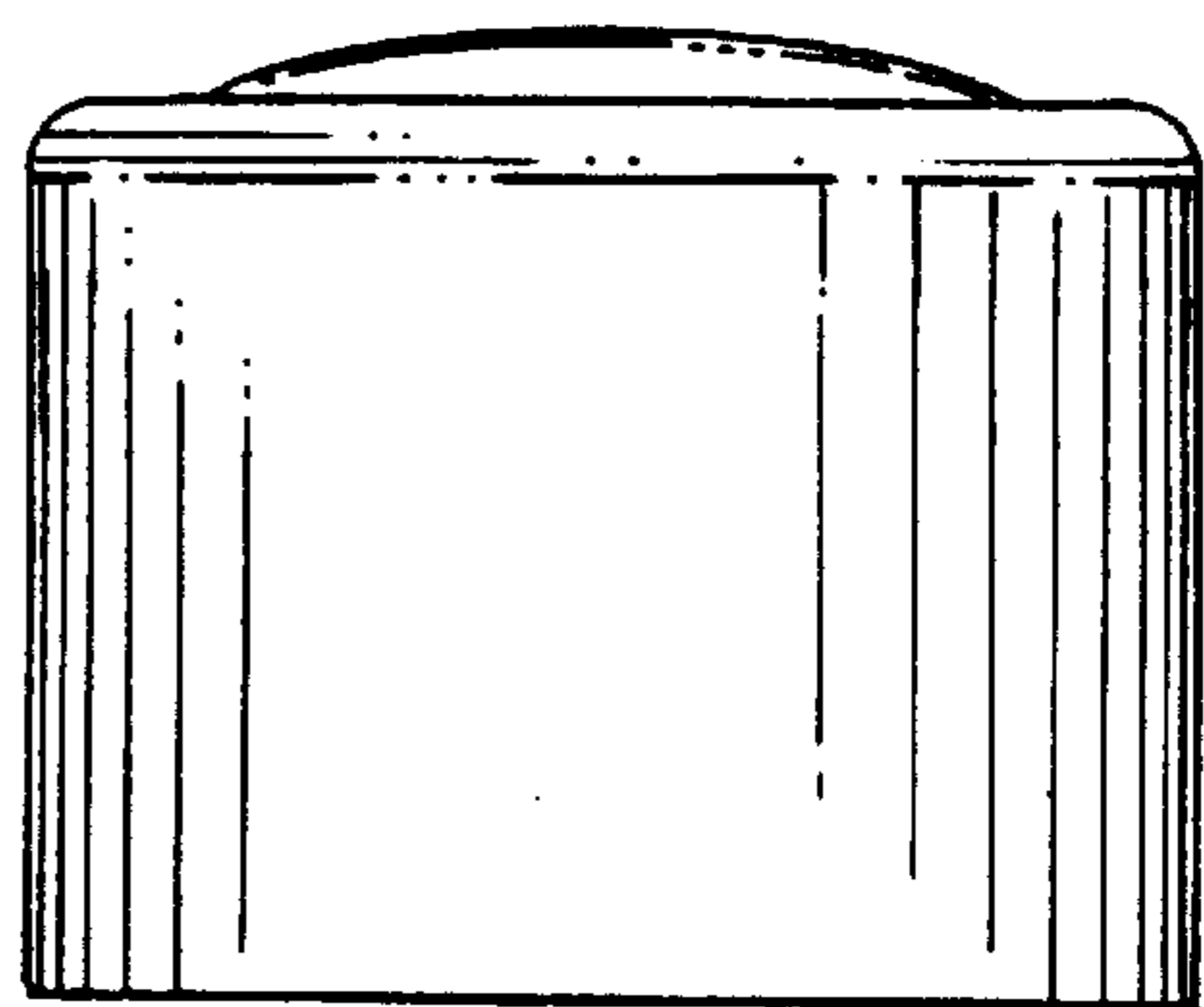

FIG. 10

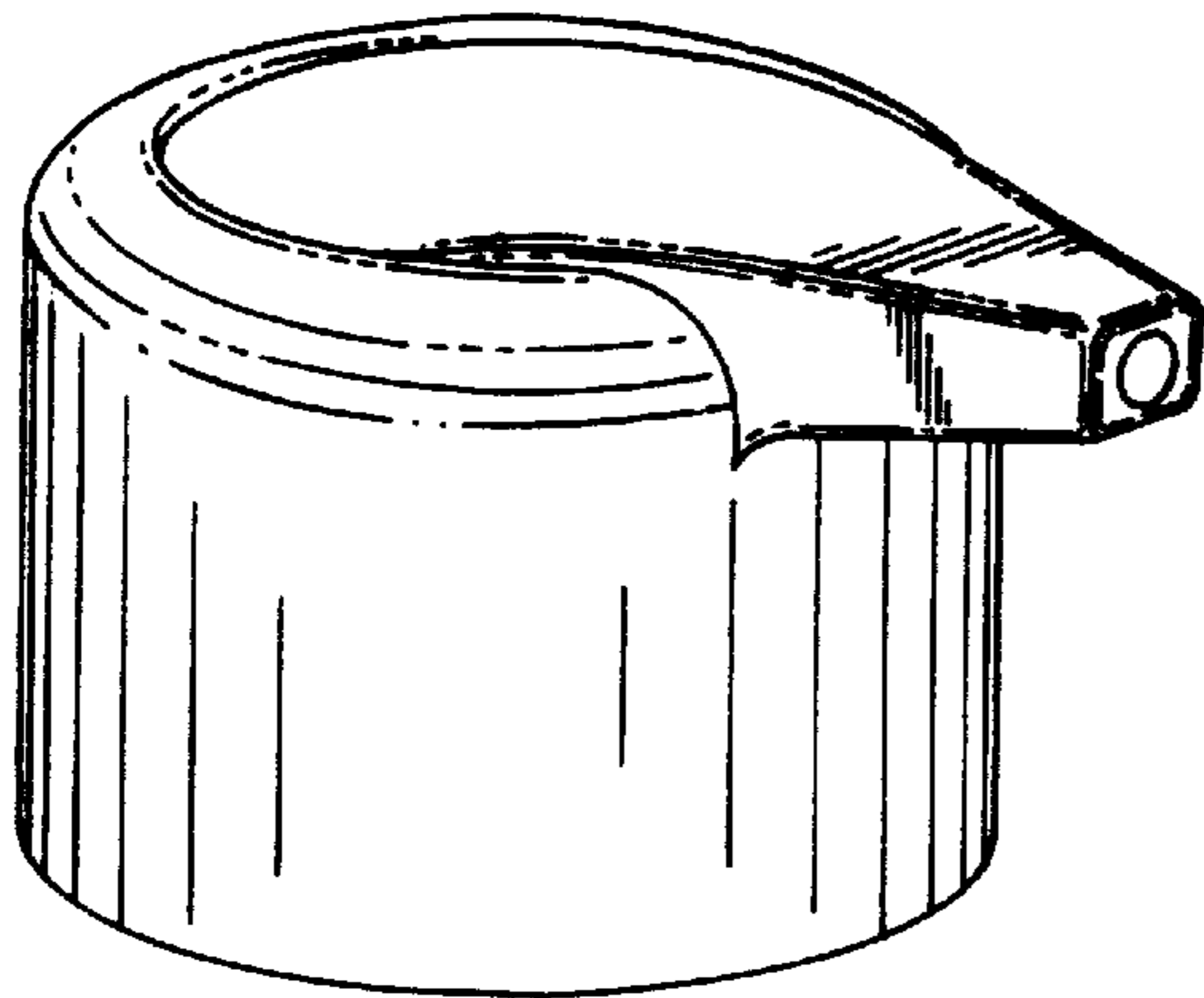

FIG. 11

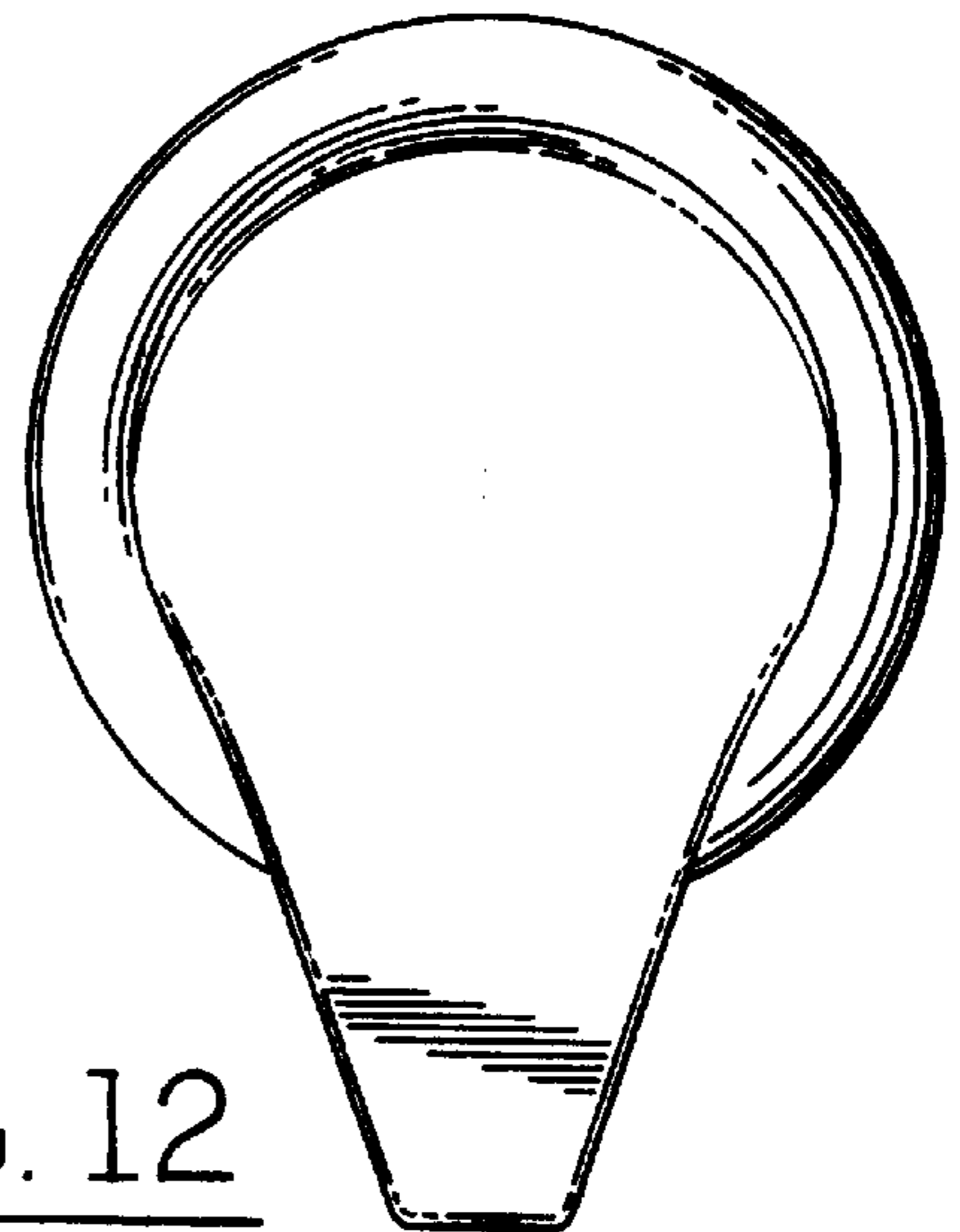

FIG. 12

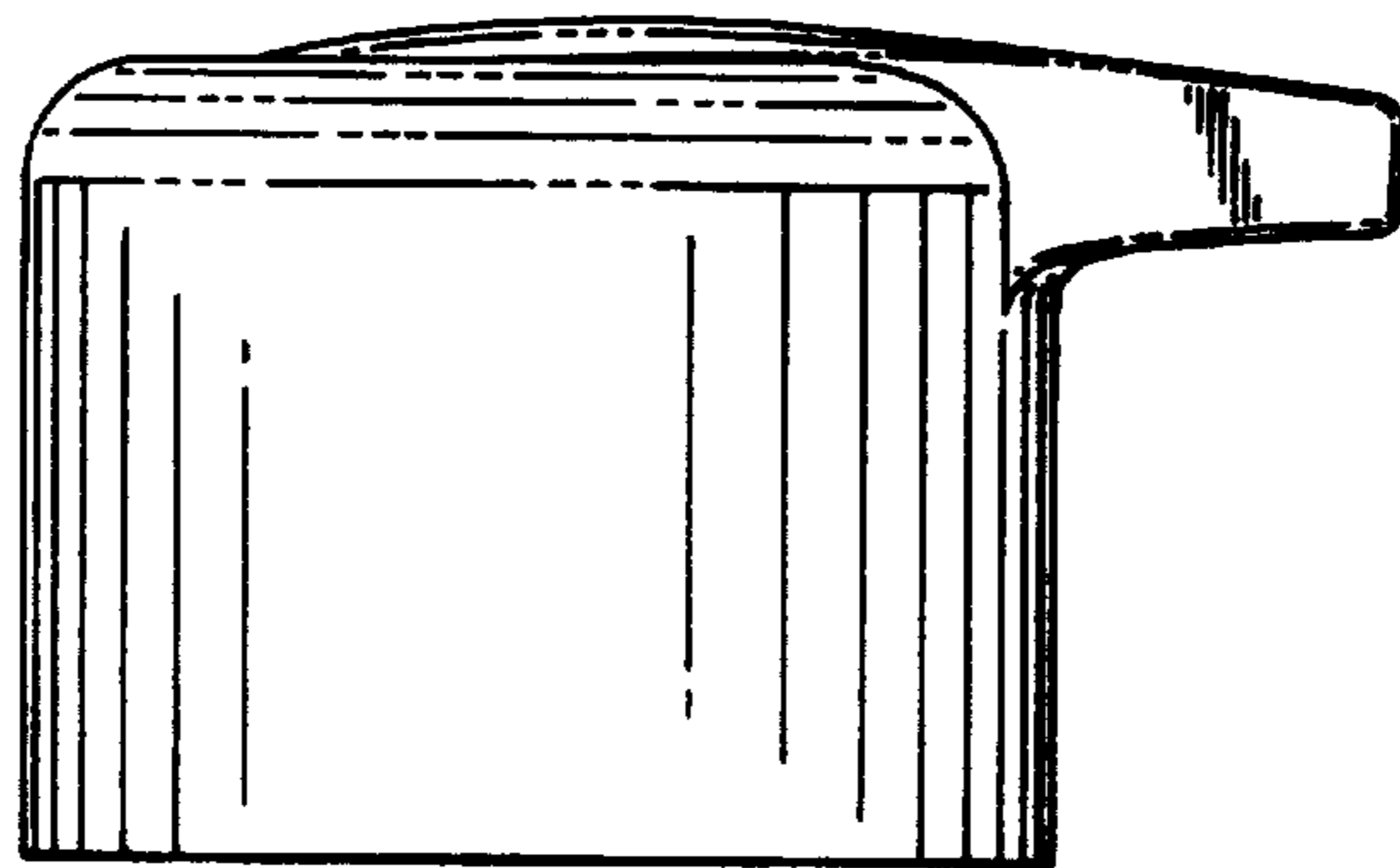

FIG. 13

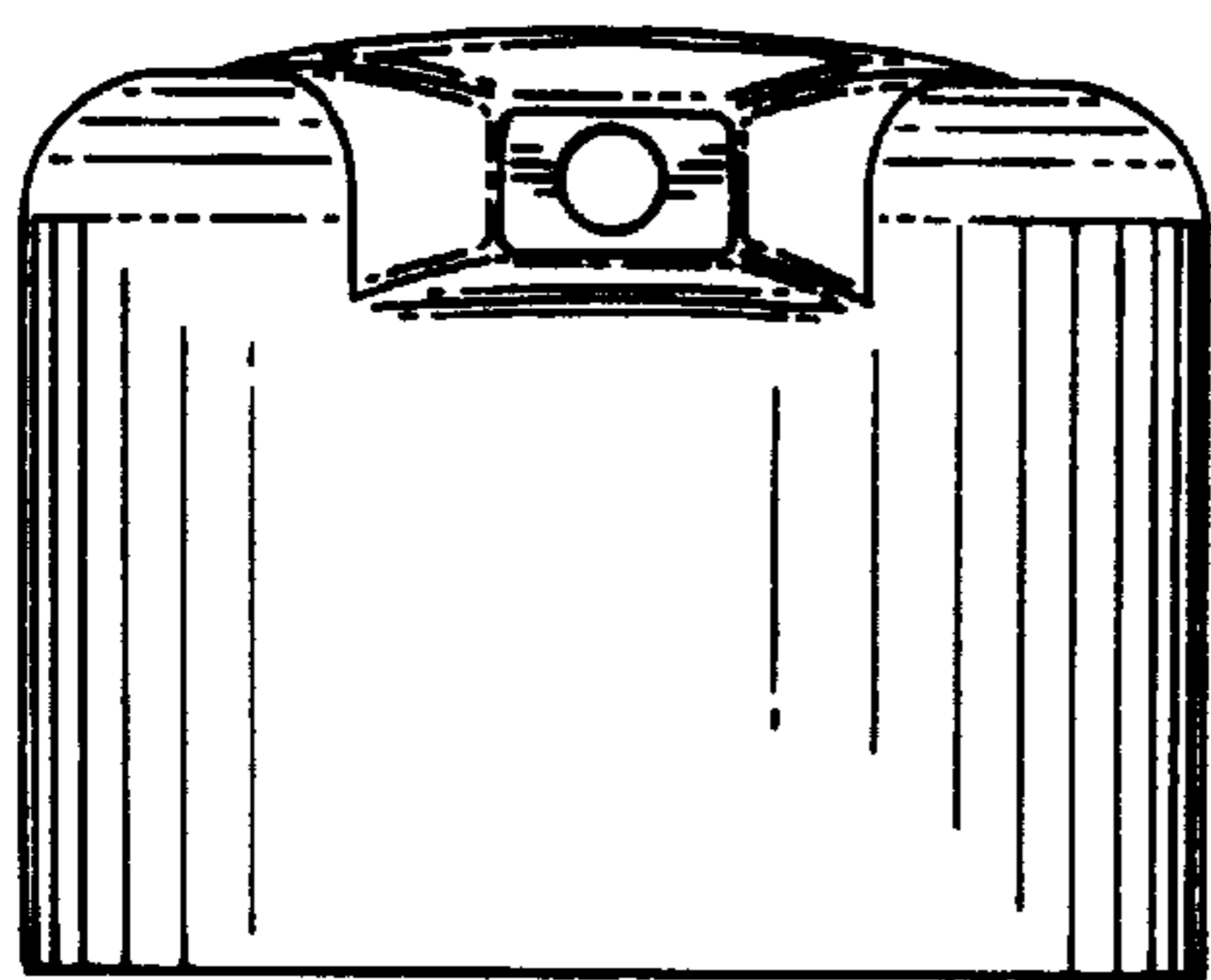

FIG. 14

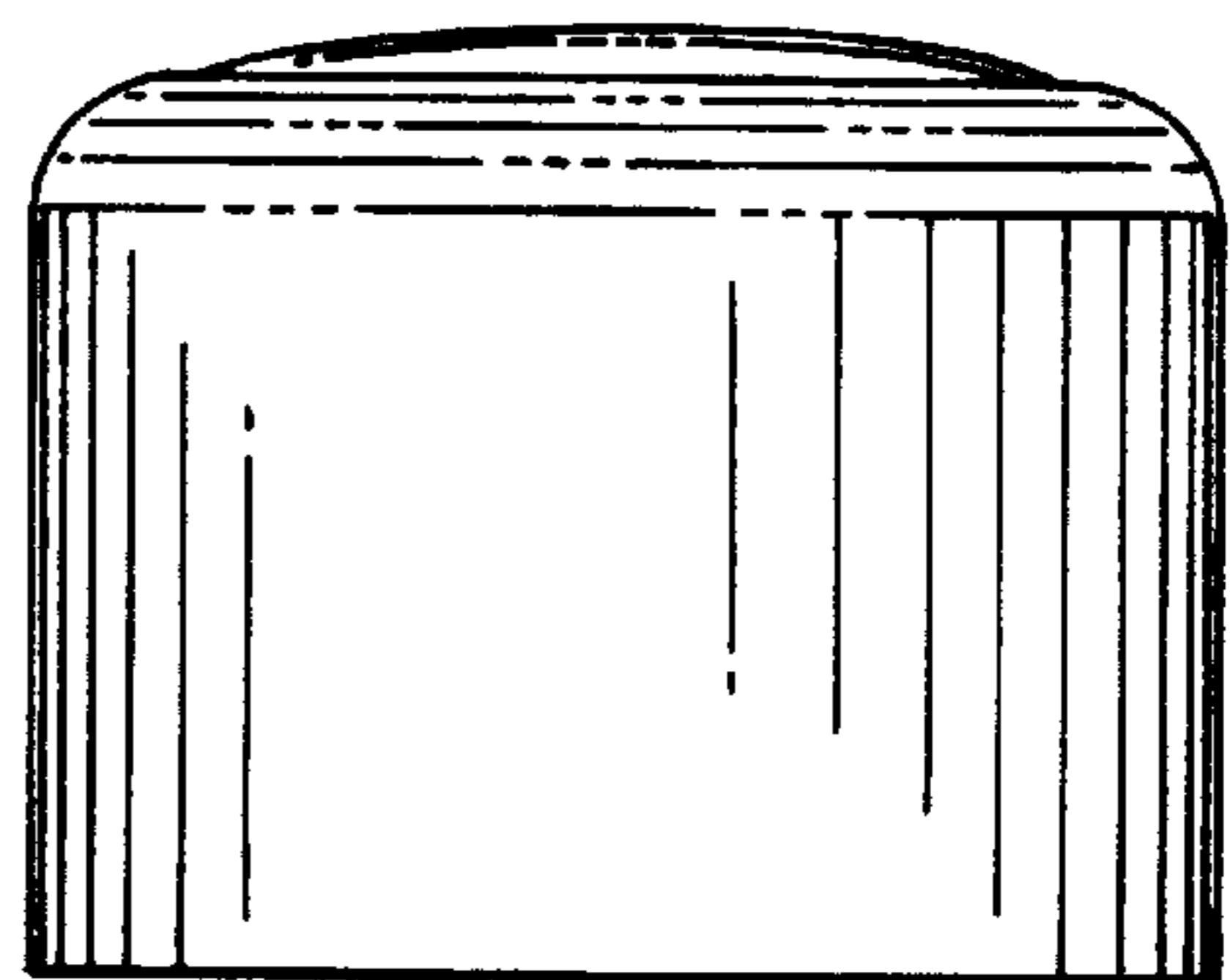

FIG. 15

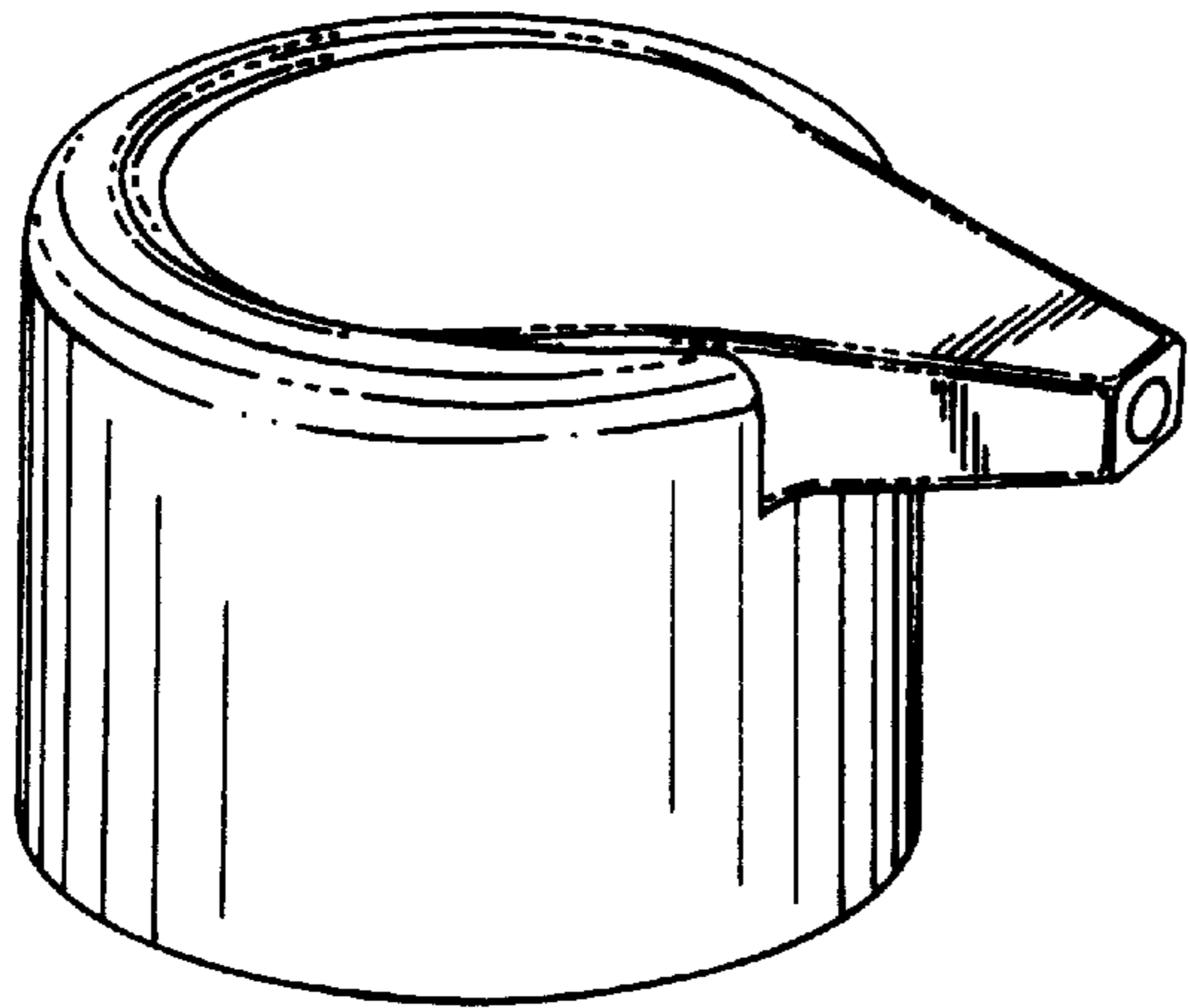

FIG. 16

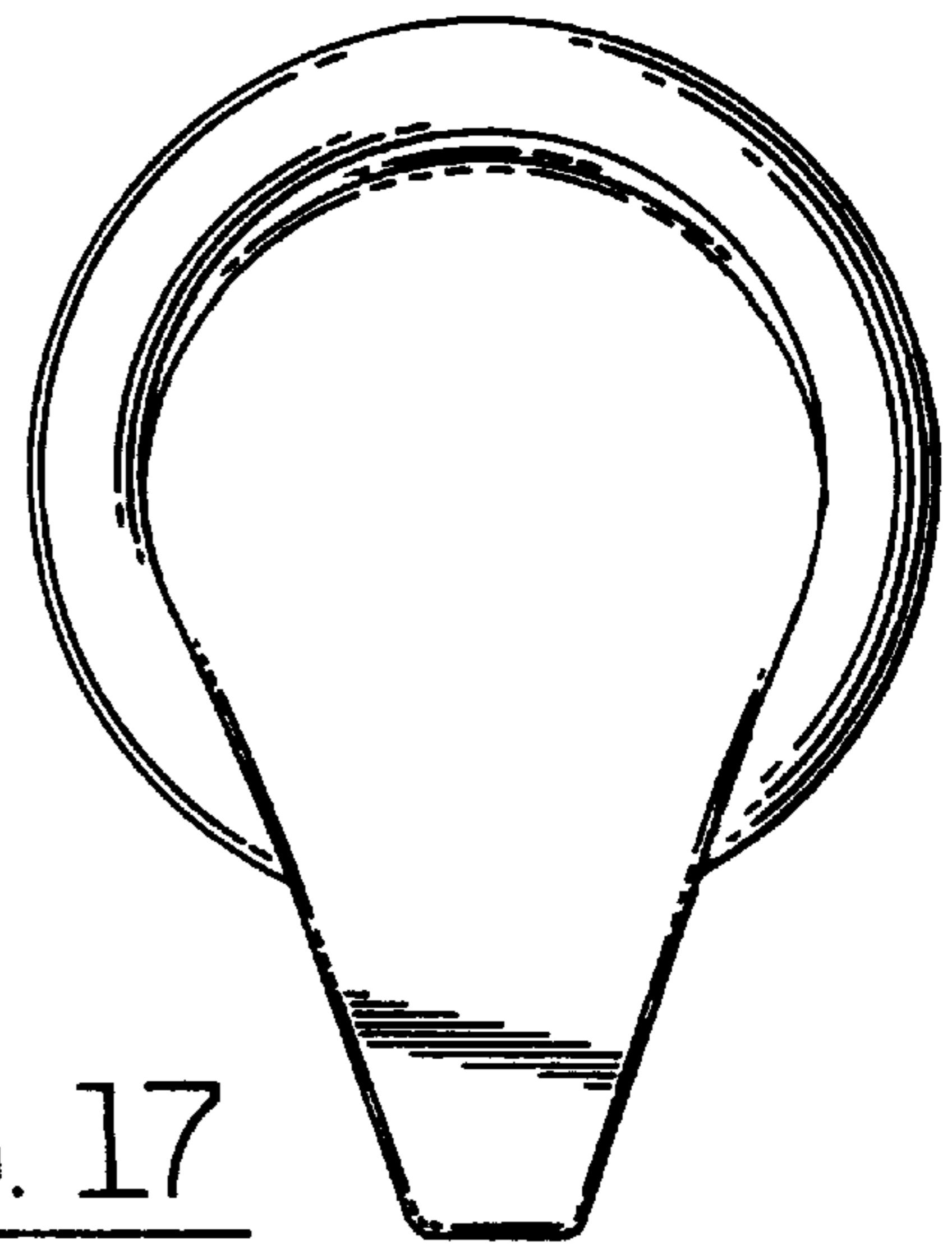

FIG. 17

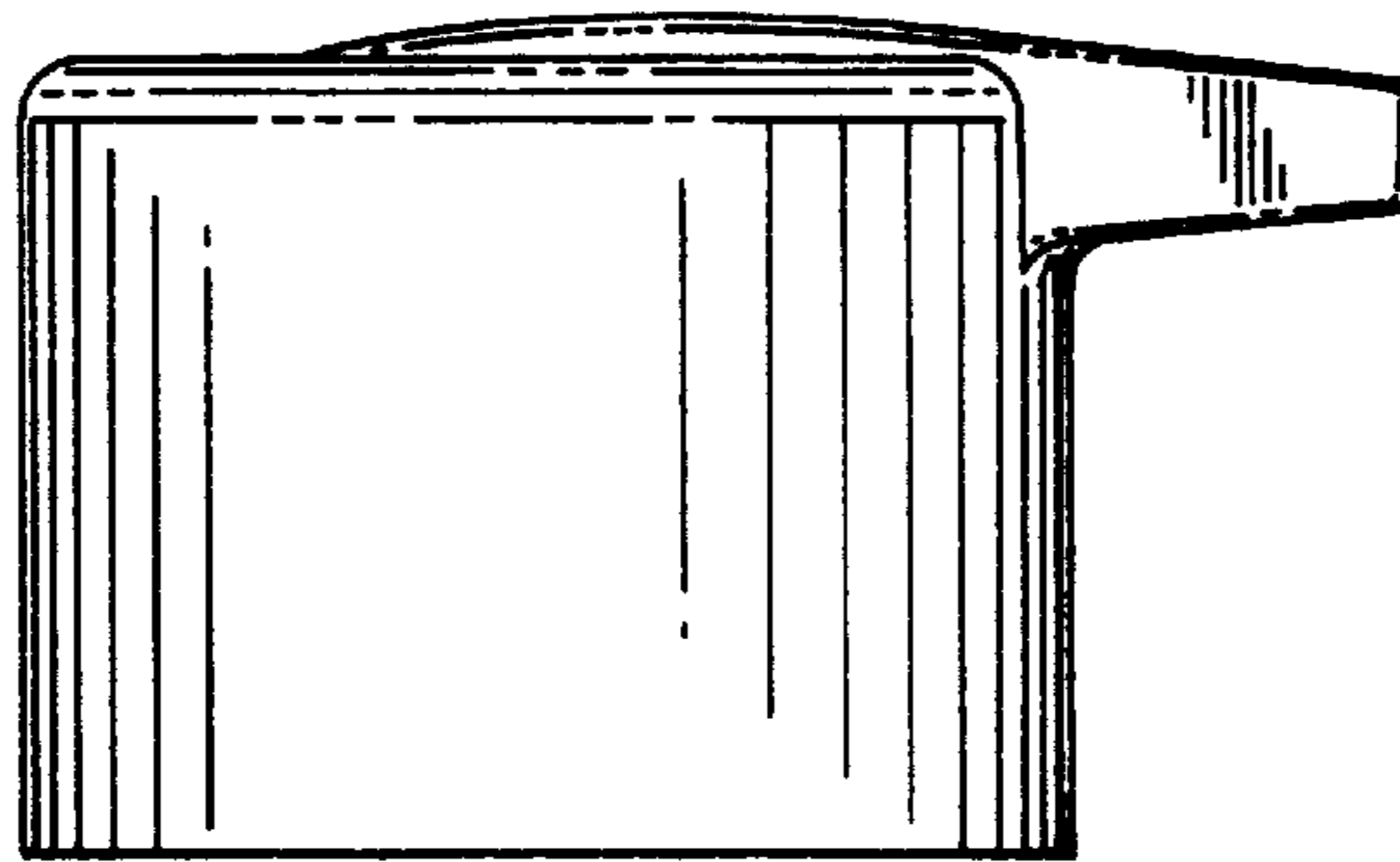

FIG. 18

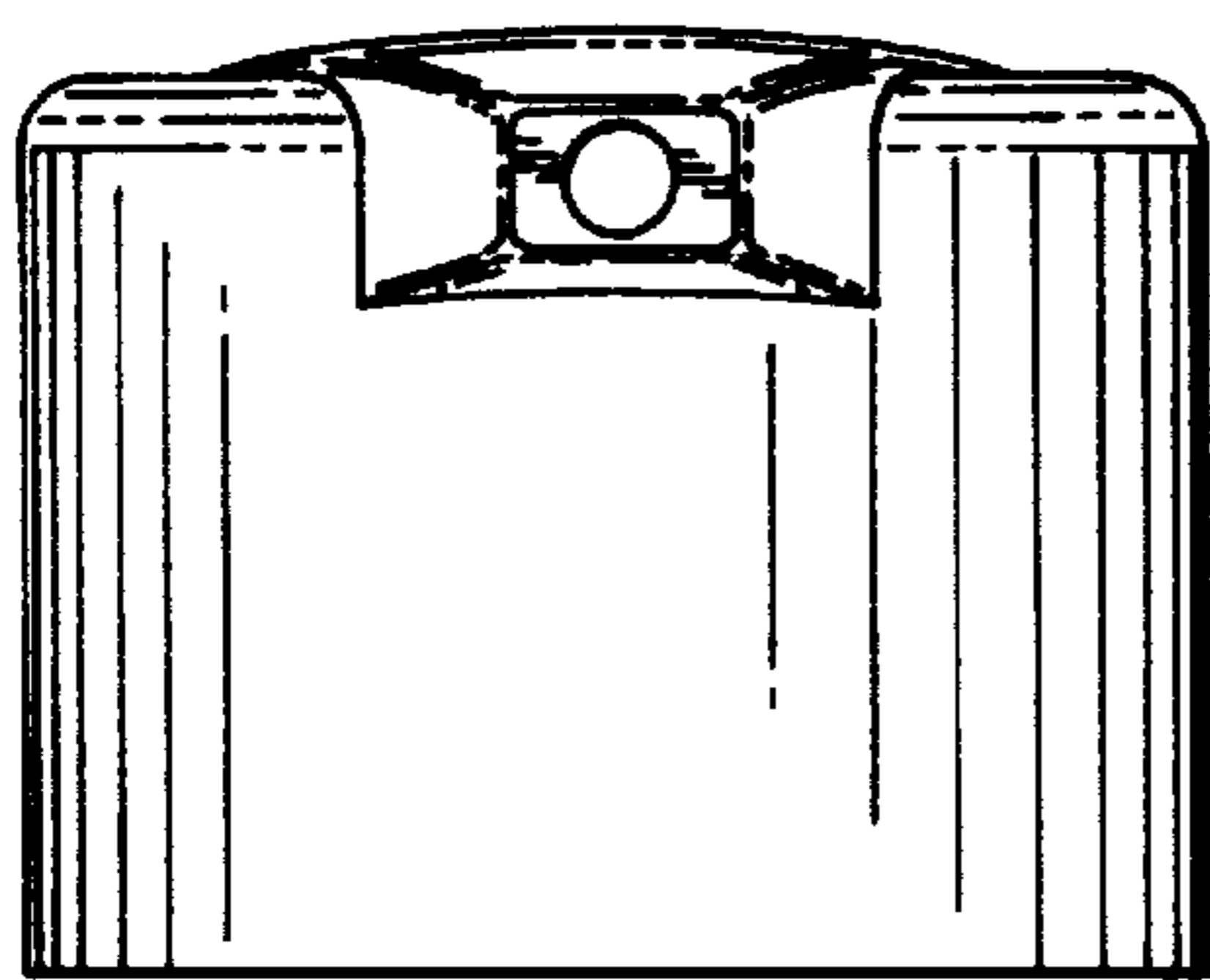

FIG. 19

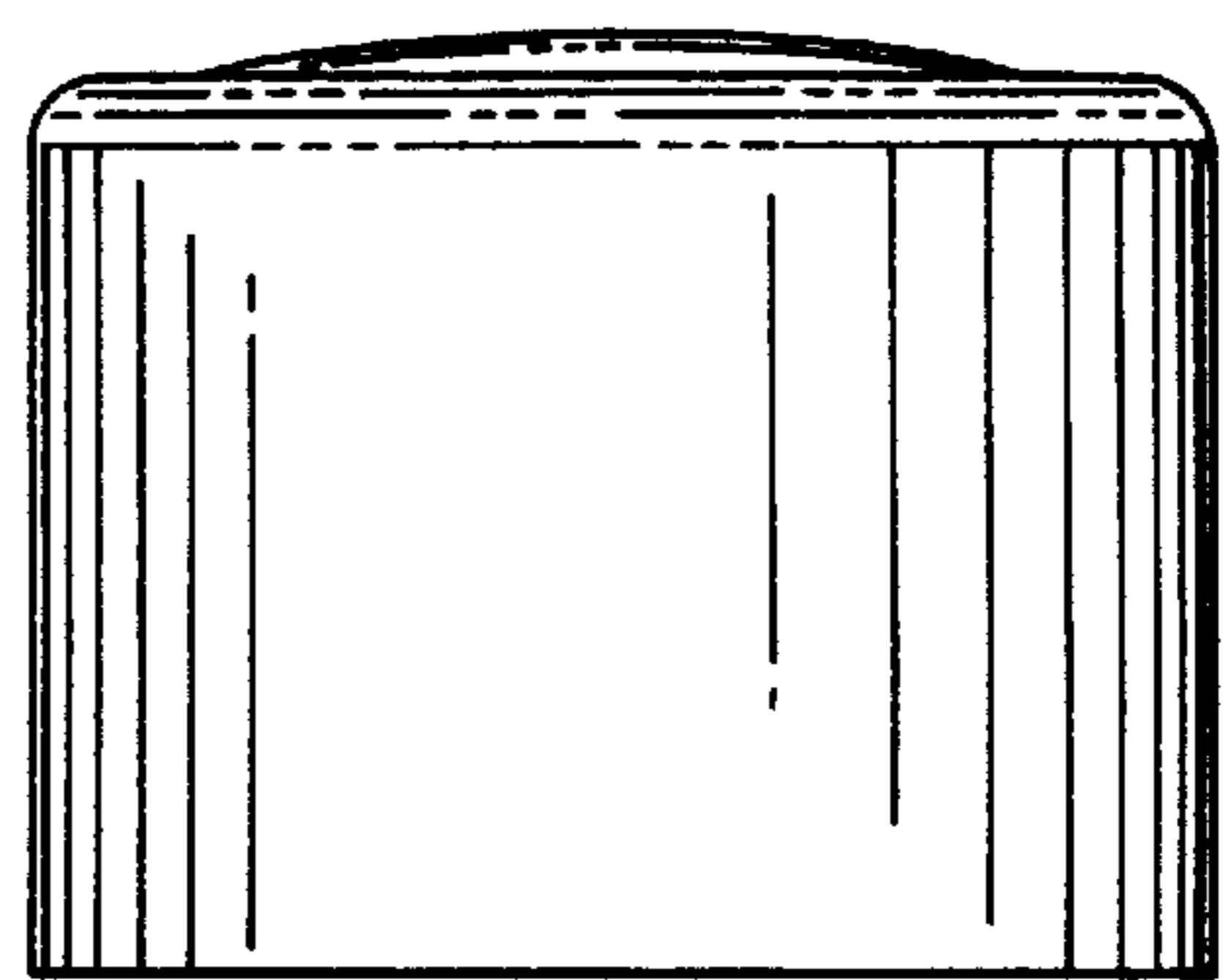

FIG. 20