



US00D419794S

United States Patent [19]

[11] **Patent Number: Des. 419,794**

Natuzzi et al.

[45] **Date of Patent: ** Feb. 1, 2000**

[54] **SEAT**

[75] Inventors: **Pasquale Natuzzi; Arcangelo Scarati,**
both of Bari, Italy

[73] Assignee: **Industrie Natuzzi, Spa,** Bari, Italy

[**] Term: **14 Years**

[21] Appl. No.: **29/095,059**

[22] Filed: **Oct. 15, 1998**

[51] **LOC (7) Cl. 06-01**

[52] **U.S. Cl. D6/381; D6/334**

[58] **Field of Search D6/334, 335, 364,**
D6/371, 373, 381, 500, 501, 502; 297/232,
445.1, 446.1

[56] **References Cited**

U.S. PATENT DOCUMENTS

D. 326,022	5/1992	Gera	D6/381
D. 354,406	1/1995	Natuzzi et al.	D6/381
D. 379,036	5/1997	Natuzzi et al.	D6/381
D. 388,260	12/1997	Natuzzi et al. .	
D. 388,261	12/1997	Natuzzi et al.	D6/381
D. 388,970	1/1998	Natuzzi et al.	D6/381
D. 399,363	10/1998	Natuzzi et al.	D6/381

OTHER PUBLICATIONS

Furniture Today, p. 132, Chateau d'Ax sofa at bottom, Oct. 20, 1997.

Natuzzi Model 452, Oct. 1988, at International Home Furnishings Market in High Point, North Carolina.

Natuzzi Model 848, Apr. 1991, at International Home Furnishings Market in High Point, North Carolina.

Natuzzi Model 864, Oct. 1991, at International Home Furnishings Market in High Point, North Carolina.

Natuzzi Model 875, Oct. 1991, at International Home Furnishings Market in High Point, North Carolina.

Natuzzi Model 879, Apr. 1991, at International Home Furnishings Market in High Point, North Carolina.

Natuzzi Model 882, Oct. 1991, at International Home Furnishings Market in High Point, North Carolina.

Natuzzi Model 903, Apr. 1992, at International Home Furnishings Market in High Point, North Carolina.

Natuzzi Model 907, Apr. 1992, at International Home Furnishings Market in High Point, North Carolina.

Natuzzi Model 1081, Sep. 1993, at International Home Furnishings Market in High Point, North Carolina.

Natuzzi Model 1093, Sep. 1993, at International Home Furnishings Market in High Point, North Carolina.

Natuzzi Model 1114, Oct. 1993, at International Home Furnishings Market in High Point, North Carolina.

(List continued on next page.)

Primary Examiner—Gary D. Watson

Attorney, Agent, or Firm—Alston & Bird LLP

[57] **CLAIM**

The ornamental design for a seat, as shown and described.

DESCRIPTION

FIG. 1 is a front perspective view of a seat showing our new design in the form of a sofa;

FIG. 2 is a front elevational view thereof;

FIG. 3 is a top plan view thereof;

FIG. 4 is a right side elevational view, the left side being a mirror image thereof;

FIG. 5 is a rear perspective view thereof;

FIG. 6 is a front elevational view of a seat showing our new design in the form of a loveseat; and,

FIG. 7 is a front elevational view of a seat showing our new design in the form of a chair.

The broken lines shown herein are for illustrative purposes only and form no part of the claimed design.

The end views of FIGS. 6 and 7 are like that shown in FIG. 4.

The rear views of FIGS. 6 and 7 are like FIG. 5, the difference being a matter of length.

FIGS. 2 through 7 are shown on a reduced scale with respect to FIG. 1.

1 Claim, 3 Drawing Sheets

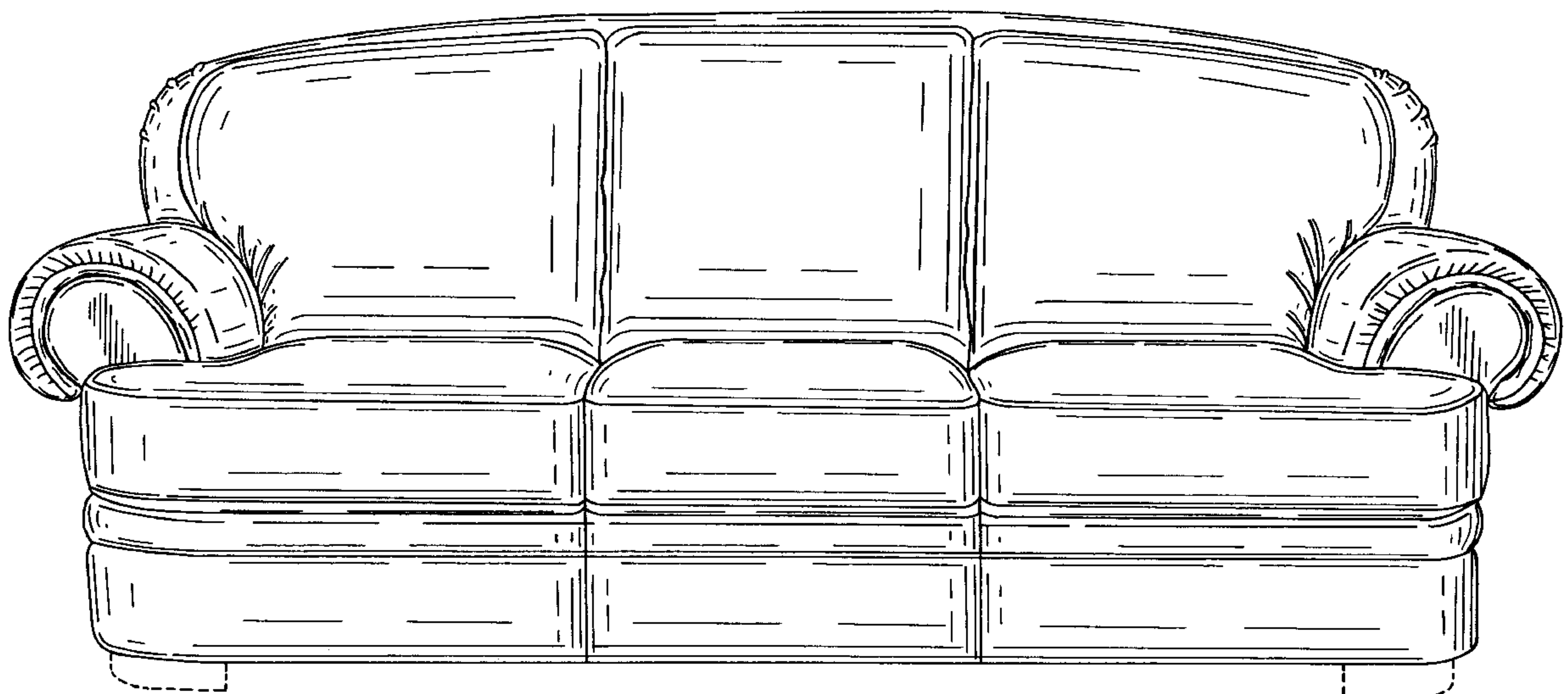

OTHER PUBLICATIONS

- Natuzzi Model 1117, Jan. 1994, at International Home Furnishings Market in High Point, North Carolina.
- Natuzzi Model 1141, Apr. 1994, at International Home Furnishings Market in High Point, North Carolina.
- Natuzzi Model 1142, Apr. 1994, at International Home Furnishings Market in High Point, North Carolina.
- Natuzzi Model 1157, Apr. 1994, at International Home Furnishings Market in High Point, North Carolina.
- Natuzzi Model 1183, Apr. 1994, at International Home Furnishings Market in High Point, North Carolina.
- Natuzzi Model 1202, Oct. 1994, at International Home Furnishings Market in High Point, North Carolina.
- Natuzzi Model 1291, Mar. 1995, at International Home Furnishings Market in High Point, North Carolina.
- Natuzzi Model 1295, Mar. 1995, at International Home Furnishings Market in High Point, North Carolina.
- Natuzzi Model 1299, Apr. 1995, at International Home Furnishings Market in High Point, North Carolina.
- Natuzzi Model 1321, Apr. 1995, at International Home Furnishings Market in High Point, North Carolina.
- Natuzzi Model 1346, Sep. 1995, at International Home Furnishings Market in High Point, North Carolina.
- Natuzzi Model 1349, Sep. 1995, at International Home Furnishings Market in High Point, North Carolina.
- Natuzzi Model 1431, Mar. 1996, at International Home Furnishings Market in High Point, North Carolina.
- Natuzzi Model 1432, Mar. 1996, at International Home Furnishings Market in High Point, North Carolina.
- Natuzzi Model 1433, Mar. 1996, at International Home Furnishings Market in High Point, North Carolina.
- Natuzzi Model 1434, Mar. 1996, at International Home Furnishings Market in High Point, North Carolina (black and white line illustration also provided).
- Natuzzi Model 1450, Oct. 1996, at International Home Furnishings Market in High Point, North Carolina.
- Natuzzi Model 1496, Oct. 1996, at International Home Furnishings Market in High Point, North Carolina.

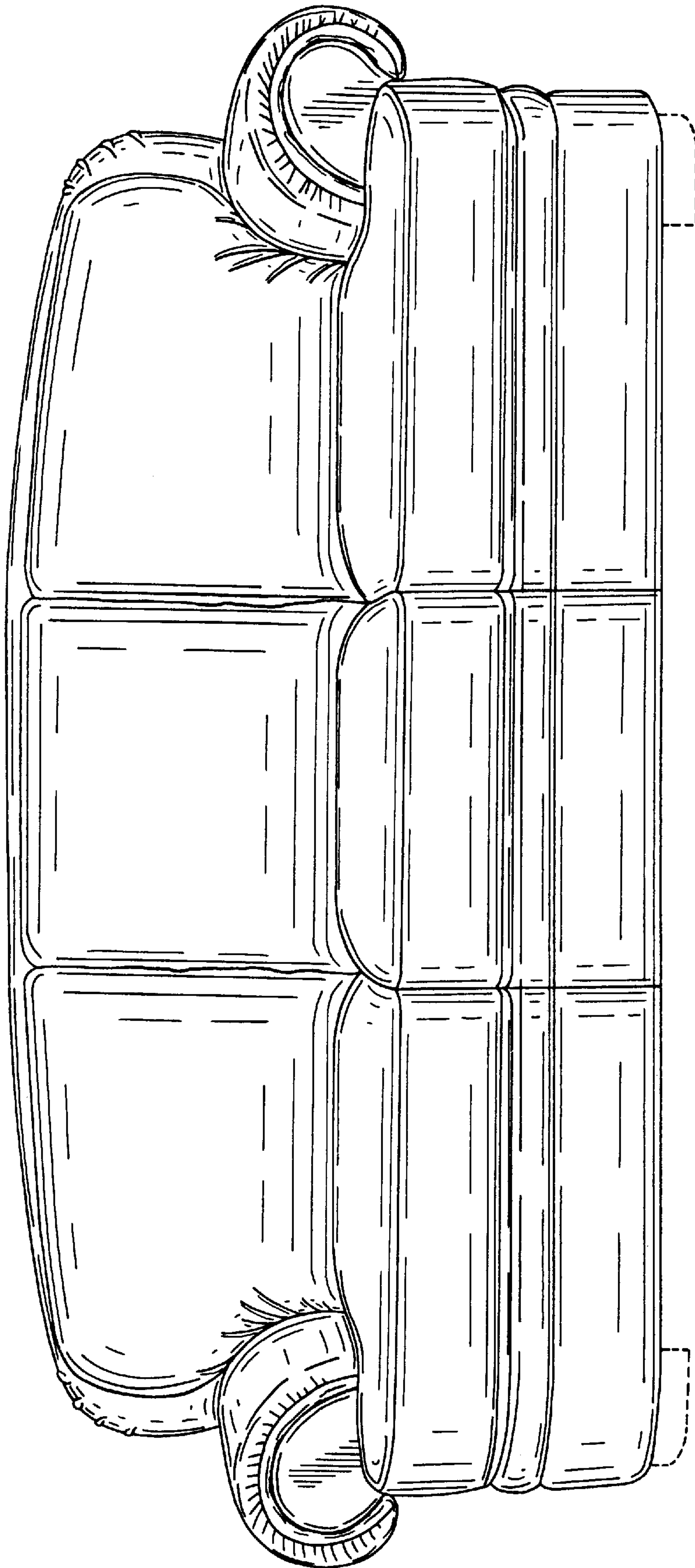

FIG. 1.



FIG. 2.

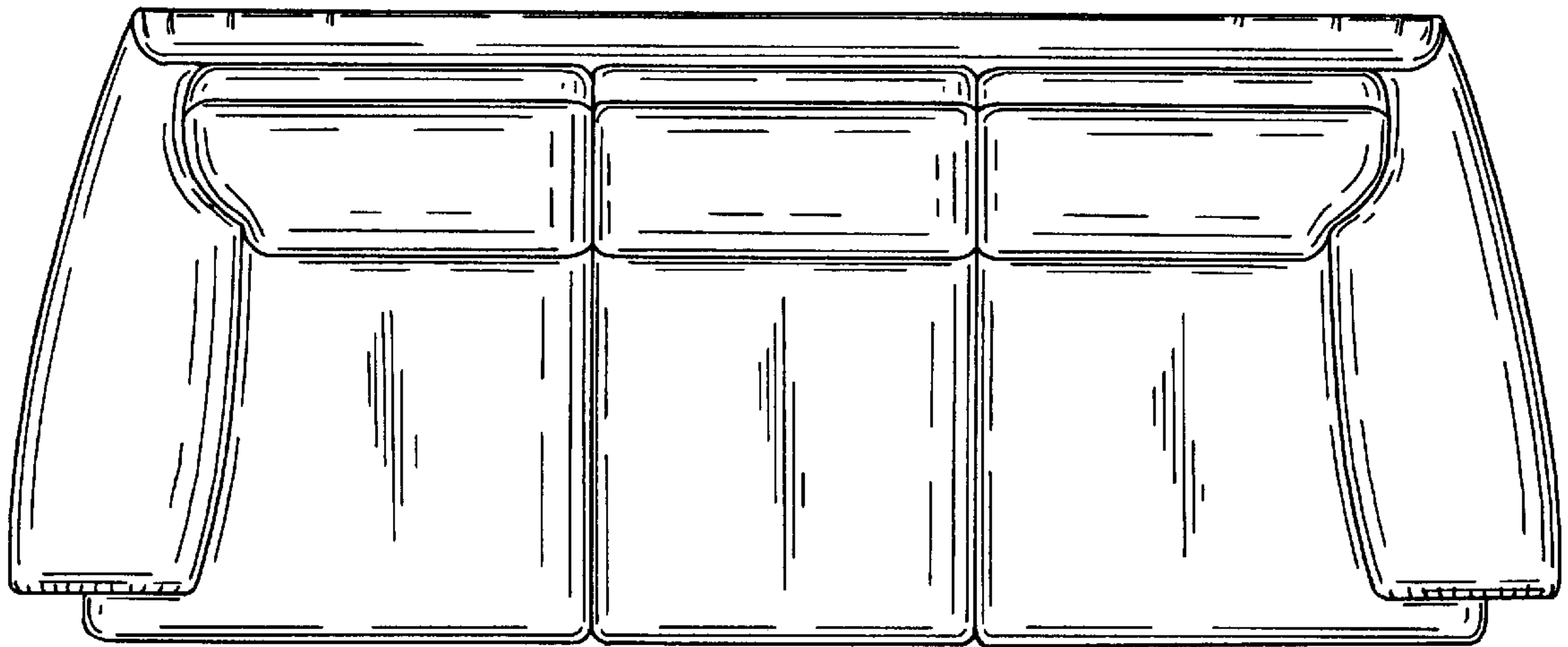

FIG. 3.

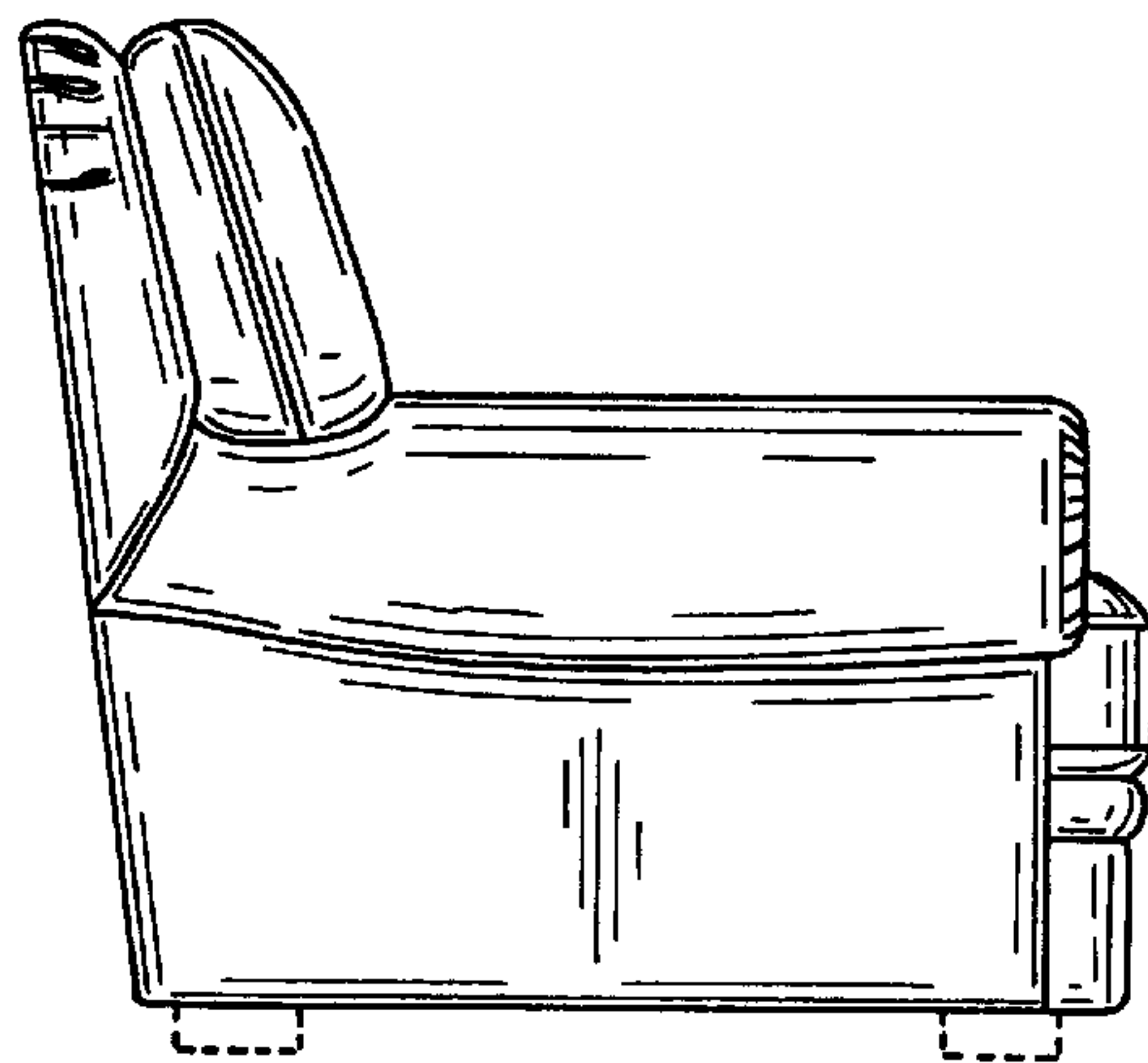

FIG. 4.

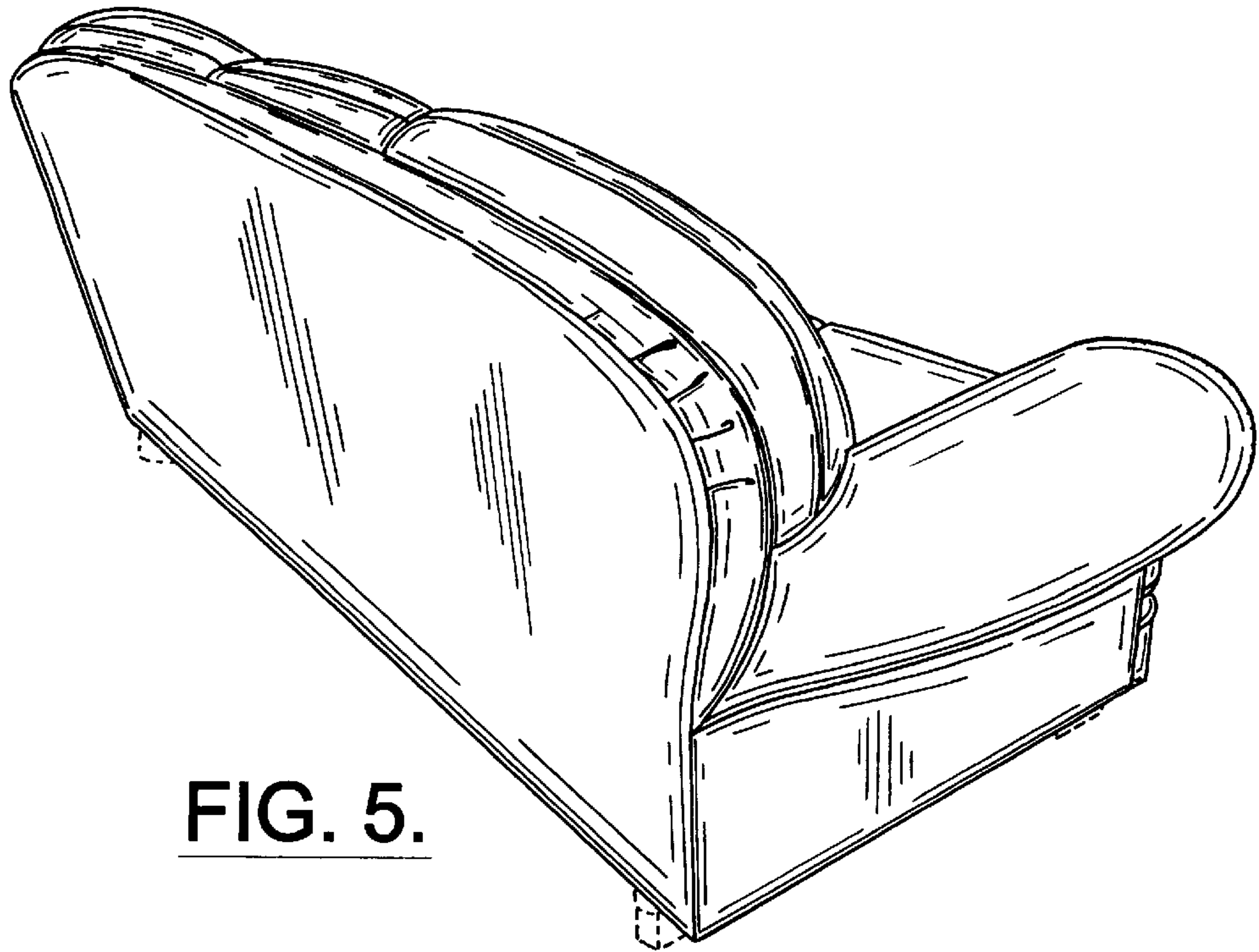

FIG. 5.

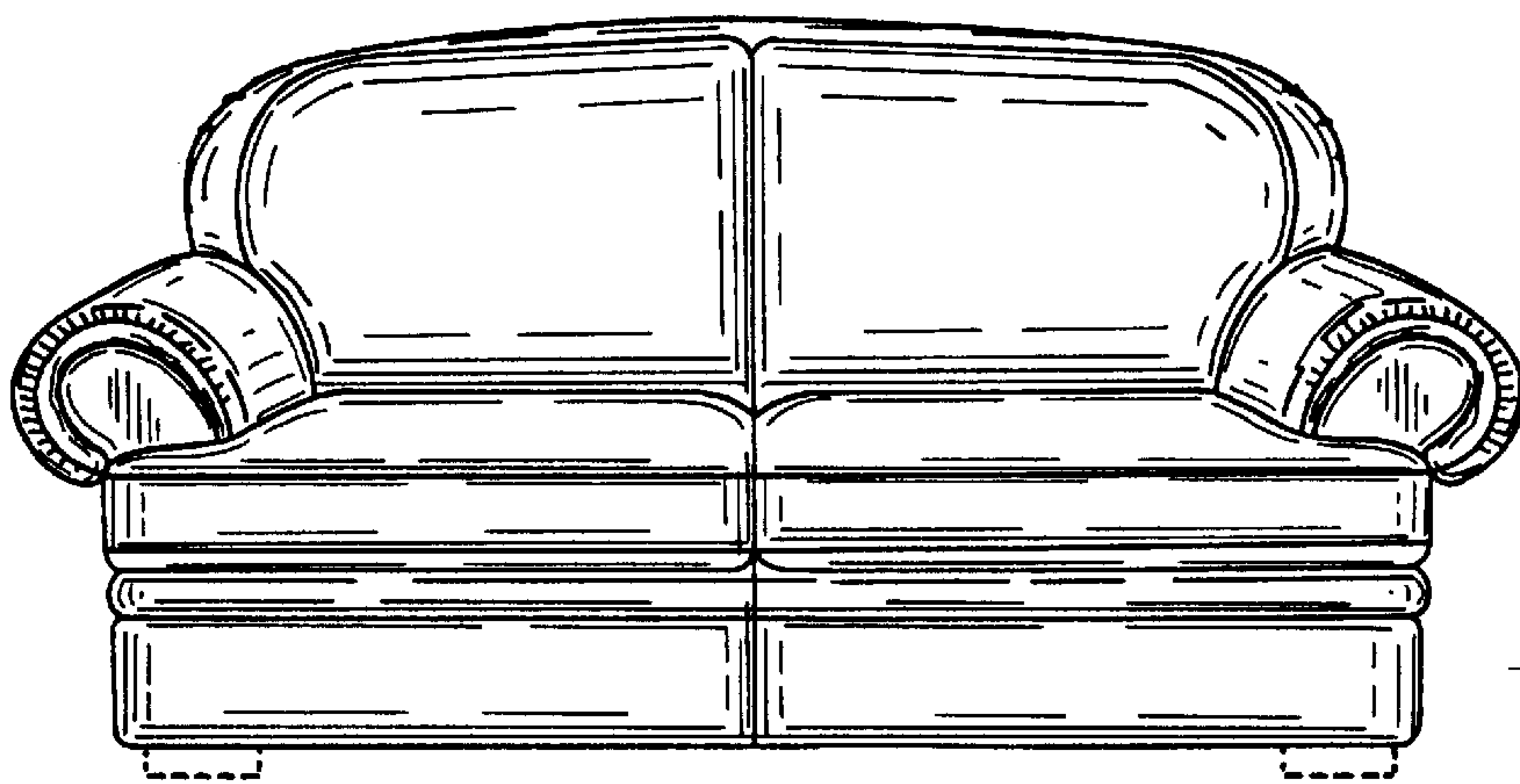

FIG. 6.

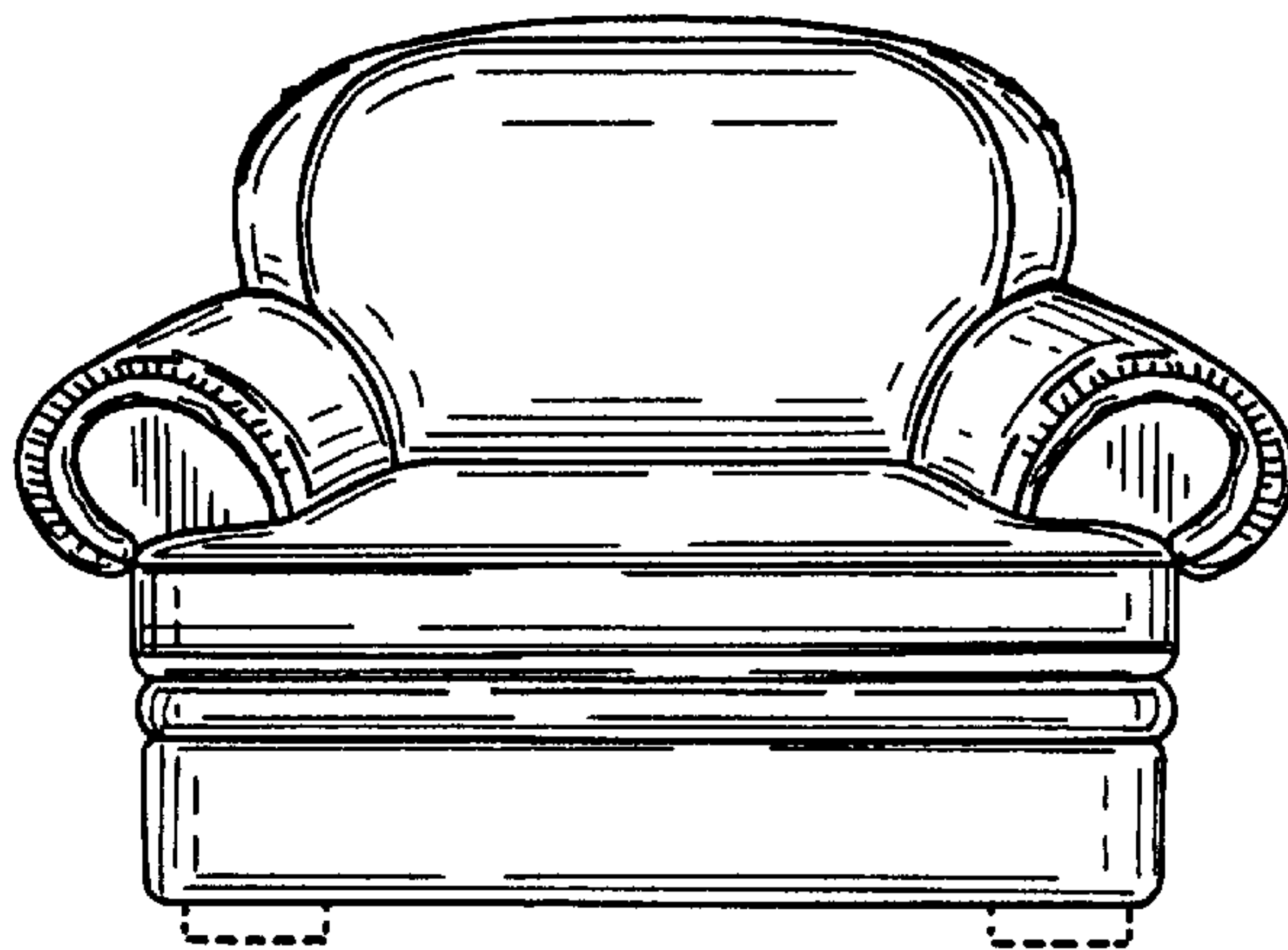

FIG. 7.