



US00D419743S

United States Patent [19] Carrillo

[11] Patent Number: **Des. 419,743**

[45] Date of Patent: **** Jan. 25, 2000**

[54] **BAG CARRIER**

[76] Inventor: **Alberto Carrillo**, 5353 Newtonia Dr.,
Los Angeles, Calif. 90032

[**] Term: **14 Years**

[21] Appl. No.: **29/099,387**

[22] Filed: **Jan. 20, 1999**

[51] **LOC (7) Cl.** **12-05**

[52] **U.S. Cl.** **D34/33; D34/28**

[58] **Field of Search** D34/28, 33, 31,
D34/34; D3/213; 212/264; 414/496, 550,
563; 254/124, 8 B

[56] **References Cited**

U.S. PATENT DOCUMENTS

D. 241,839	10/1976	Kammeraad	D34/28
D. 285,378	8/1986	Norell	D34/33
D. 341,242	11/1993	Thorby	D34/33
D. 349,996	8/1994	Litwiller	D34/33
D. 376,885	12/1996	Carey et al.	D34/28
2,517,813	8/1950	Wallace, Jr.	414/496
2,628,069	2/1953	Emery et al.	254/124
3,599,812	8/1971	Hasstedt	254/8 B
3,937,415	2/1976	Prinz	254/8 B

4,657,109	4/1987	Sterner	212/264
5,205,700	4/1993	Lin et al.	414/550
5,211,297	5/1993	Vandervalk	212/264
5,281,078	1/1994	Mills, Jr.	414/563
5,520,498	5/1996	DiBartolomeo	414/550

Primary Examiner—Susan J. Lucas
Assistant Examiner—Cynthia E Ramirez
Attorney, Agent, or Firm—Goldstein & Canino

[57] **CLAIM**

The ornamental design for a bag carrier, as shown and described.

DESCRIPTION

FIG. 1 is a diagrammatic perspective view of the bag carrier in full lines with a bag shown in broken lines representing environmental association matter being for illustrative purposes only and forming no part of the claimed invention. FIG. 2 is a right side elevational view of the bag carrier. FIG. 3 is a left side elevational view thereof. FIG. 4 is a top plan view thereof. FIG. 5 is a bottom plan view thereof; and, FIG. 6 is a front elevational view of the bag carrier, the rear elevational view being a mirror image of the front view.

1 Claim, 2 Drawing Sheets

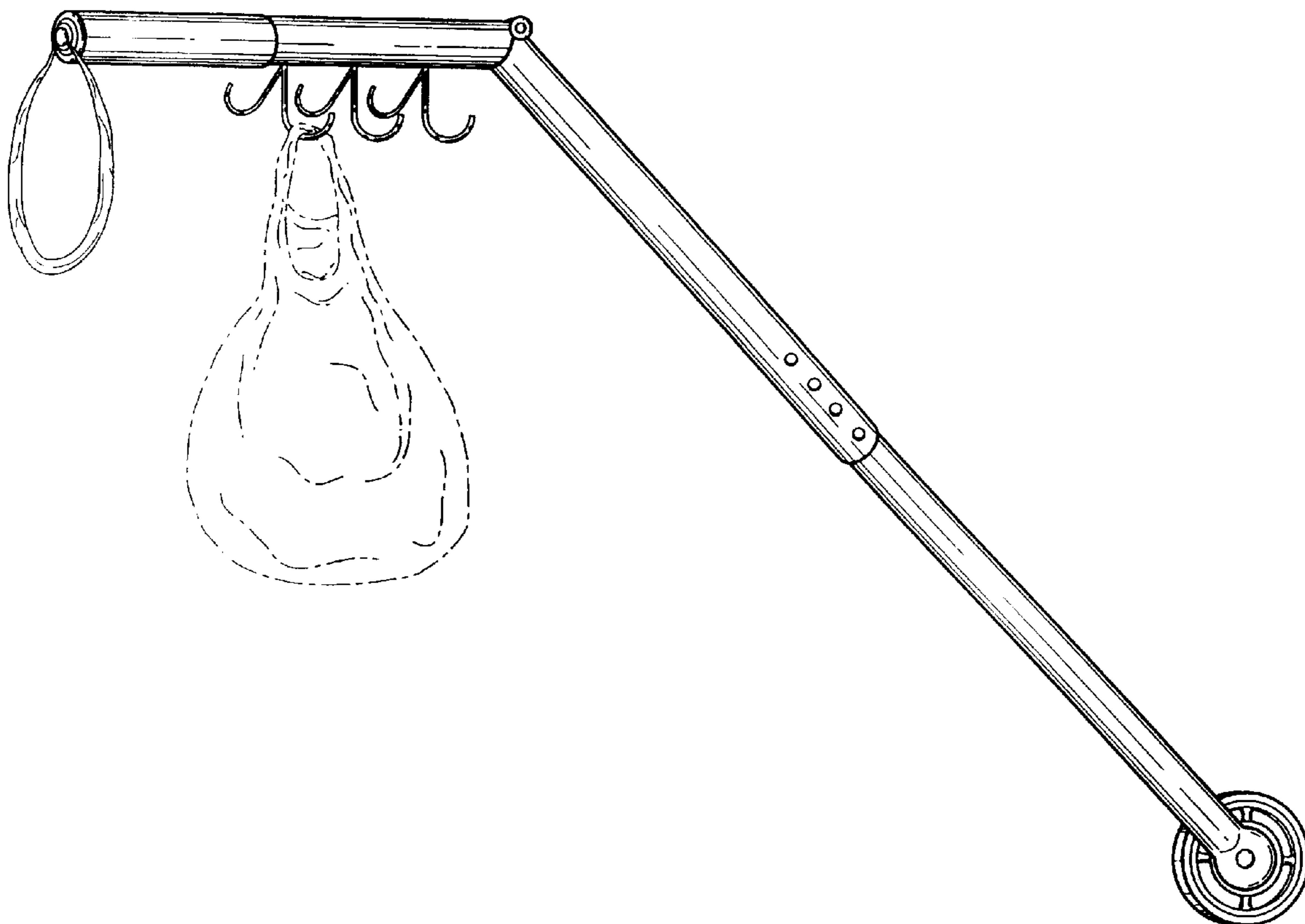

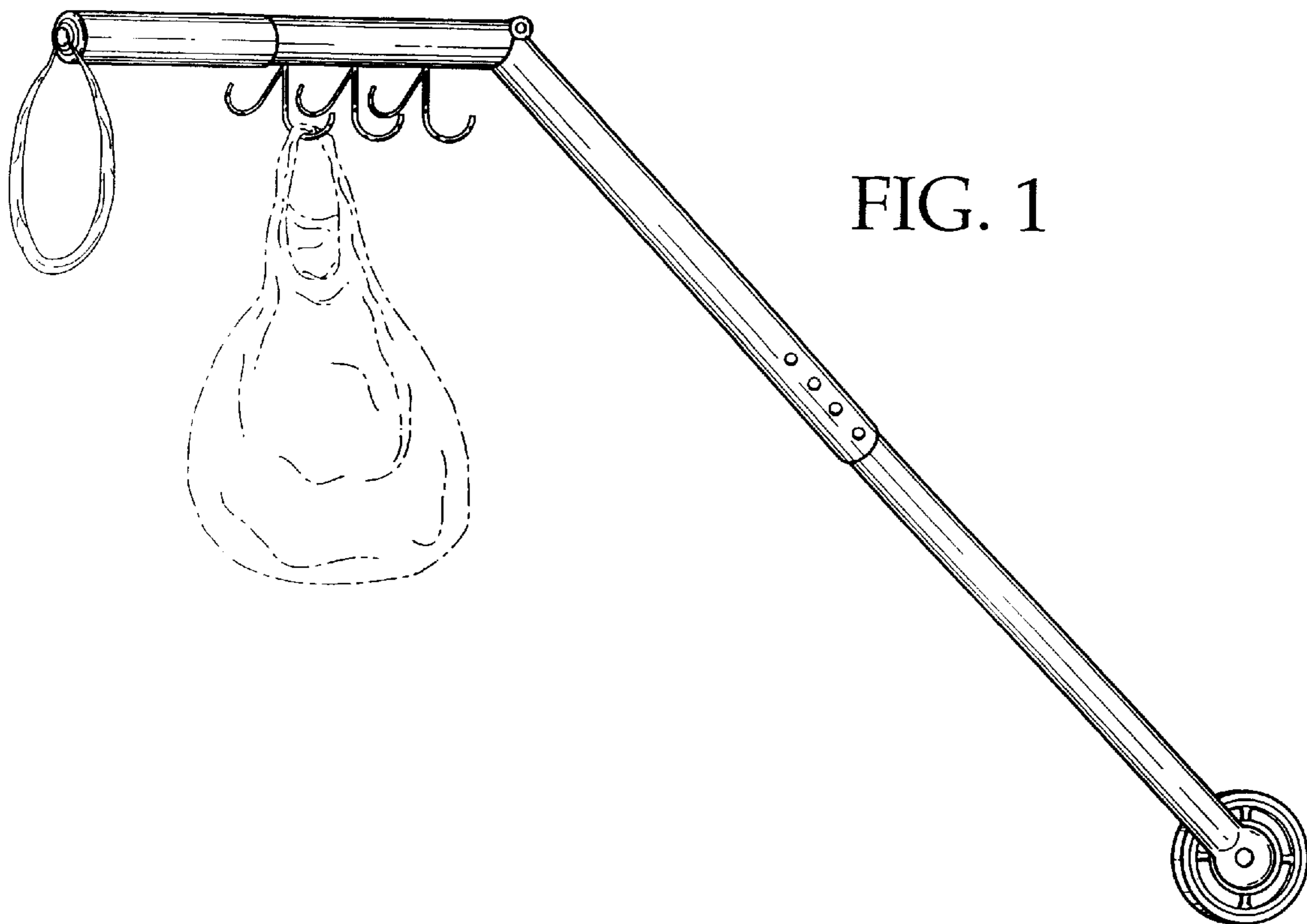

FIG. 1

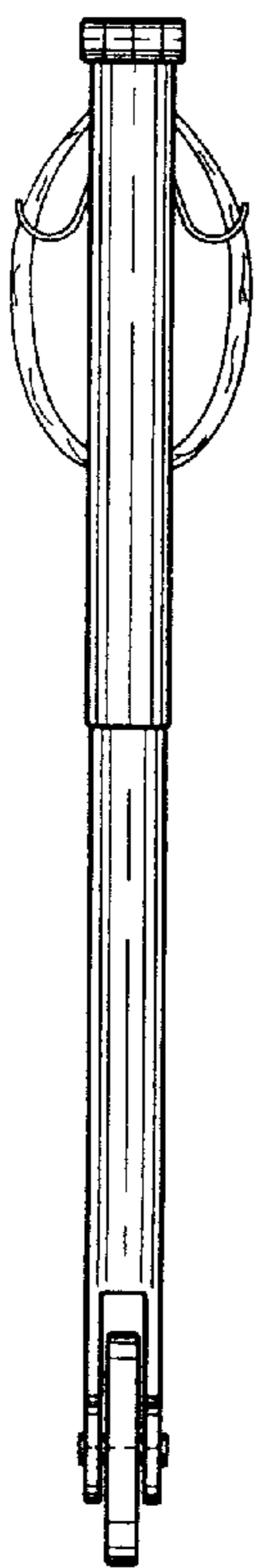

FIG. 2

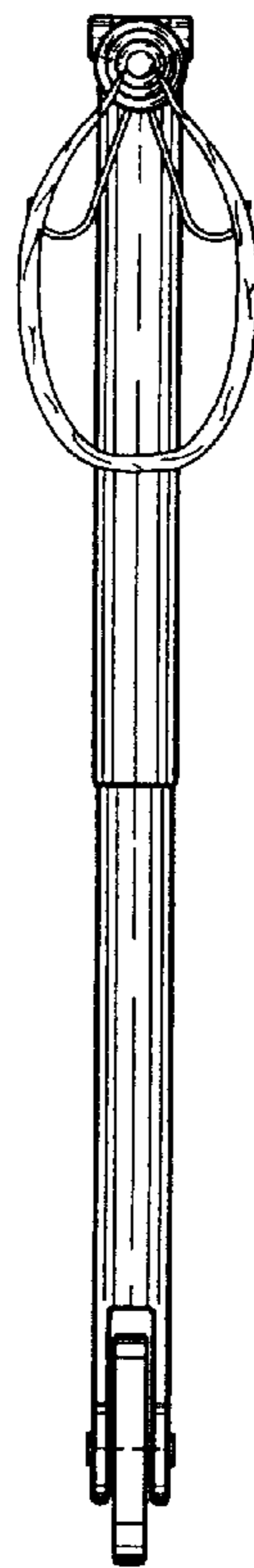

FIG. 3

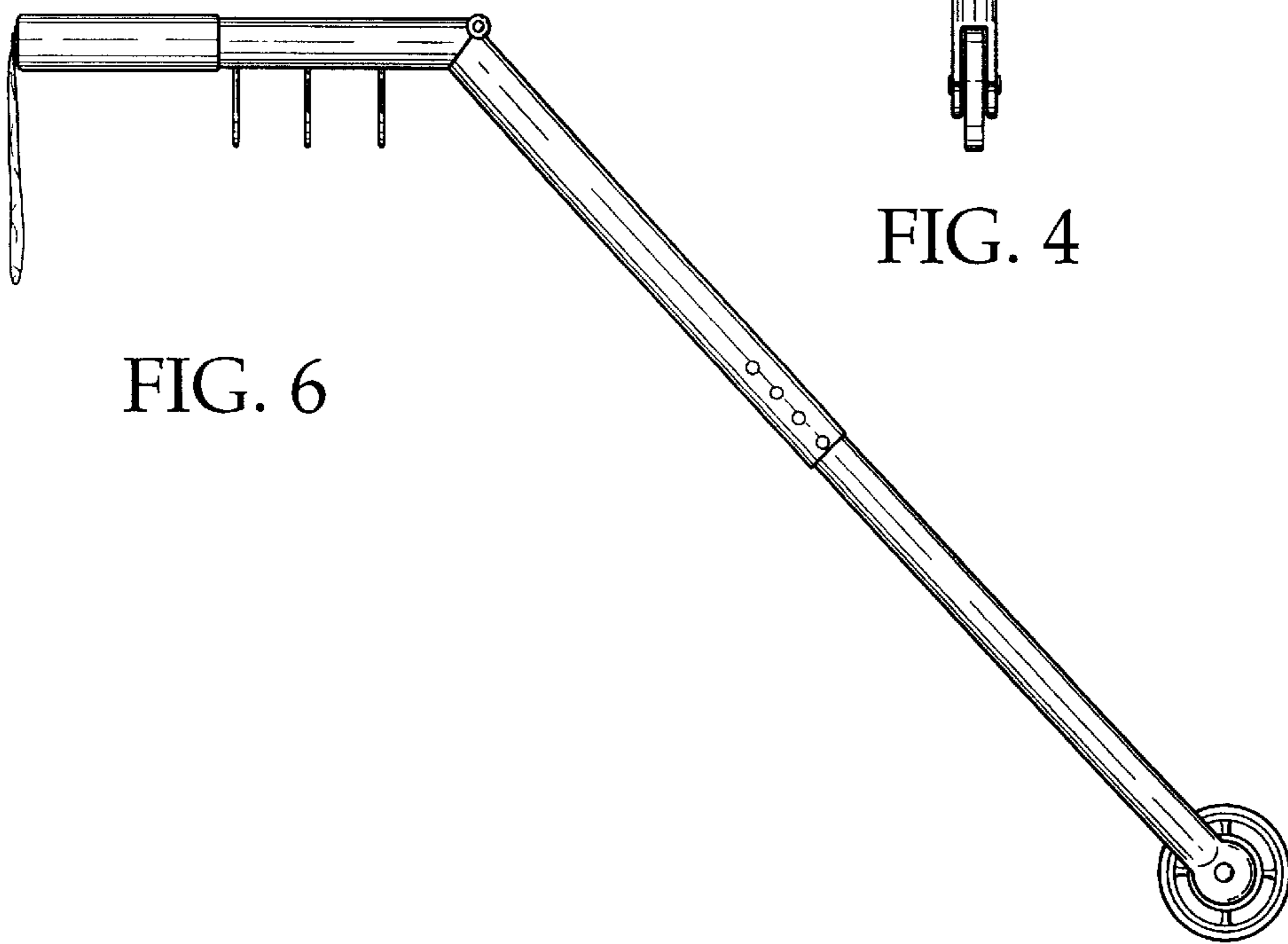

FIG. 6

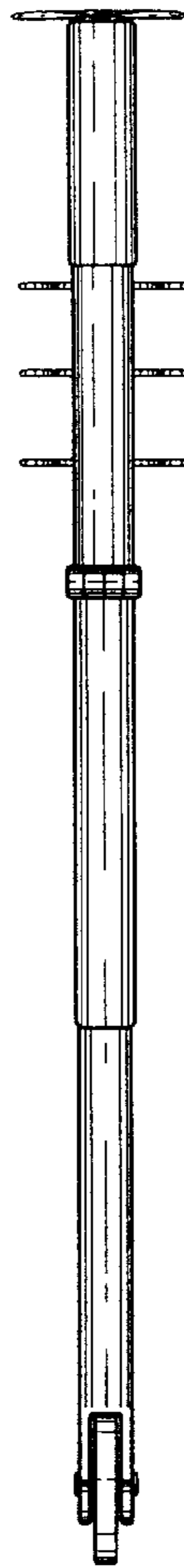

FIG. 4

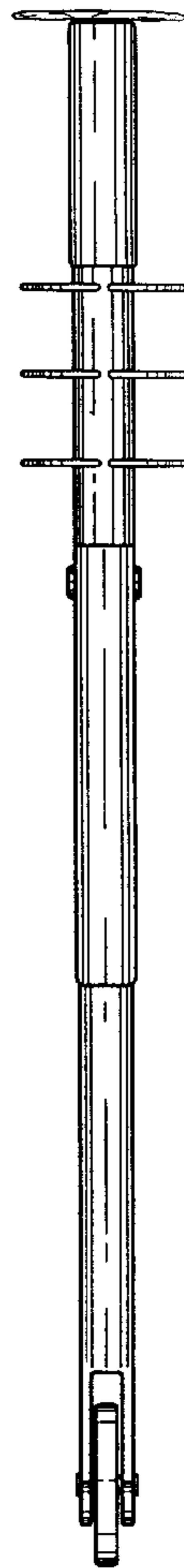

FIG. 5