



US00D419730S

United States Patent [19]

Diebel et al.

[11] Patent Number: **Des. 419,730**

[45] Date of Patent: **** Jan. 25, 2000**

[54] UPRIGHT VACUUM CLEANER

[75] Inventors: **Markus Diebel**, San Francisco; **Kevin Nason**, Mountain View, both of Calif.

[73] Assignee: **Oreck Holdings LLC**, Cheyenne, Wyo.

[**] Term: **14 Years**

[21] Appl. No.: **29/083,887**

[22] Filed: **Feb. 19, 1998**

Related U.S. Application Data

[63] Continuation of application No. 29/079,236, Nov. 10, 1997.

[51] LOC (7) Cl. **15-05**

[52] U.S. Cl. **D32/22**

[58] Field of Search D32/17-18, 21-22, D32/31-34; 15/415.1-422.1, 320-322, 350-353, 323, 362, 410-412, 414, 347, 344, 339, 411

[56] References Cited

U.S. PATENT DOCUMENTS

- D. 299,175 12/1988 Nimon et al. D32/22
- D. 359,604 6/1995 Sovis et al. D32/22

- D. 368,559 4/1996 Abe et al. D32/22
- D. 368,994 4/1996 Abe et al. D32/22
- D. 370,321 5/1996 Robinette et al. D32/22
- D. 382,681 8/1997 Thomas D32/22
- D. 403,480 12/1998 Diebel D32/22
- 5,584,095 12/1996 Redding et al. 15/411

Primary Examiner—Ruth McInroy
Attorney, Agent, or Firm—Seed and Berry LLP

[57] CLAIM

The ornamental design for an upright vacuum cleaner, as shown and described.

DESCRIPTION

FIG. 1 is a front perspective view of an upright vacuum cleaner showing my new design; FIG. 2 is a front elevational view thereof; FIG. 3 is a rear elevational view thereof; FIG. 4 is a left side elevational view thereof; FIG. 5 is a right side elevational view thereof; FIG. 6 is a top plan view thereof; and, FIG. 7 is a bottom plan view thereof.

The details shown in broken lines in FIG. 1 and 3-7 are shown for illustrative purposes only and form no part of the claimed design.

1 Claim, 6 Drawing Sheets

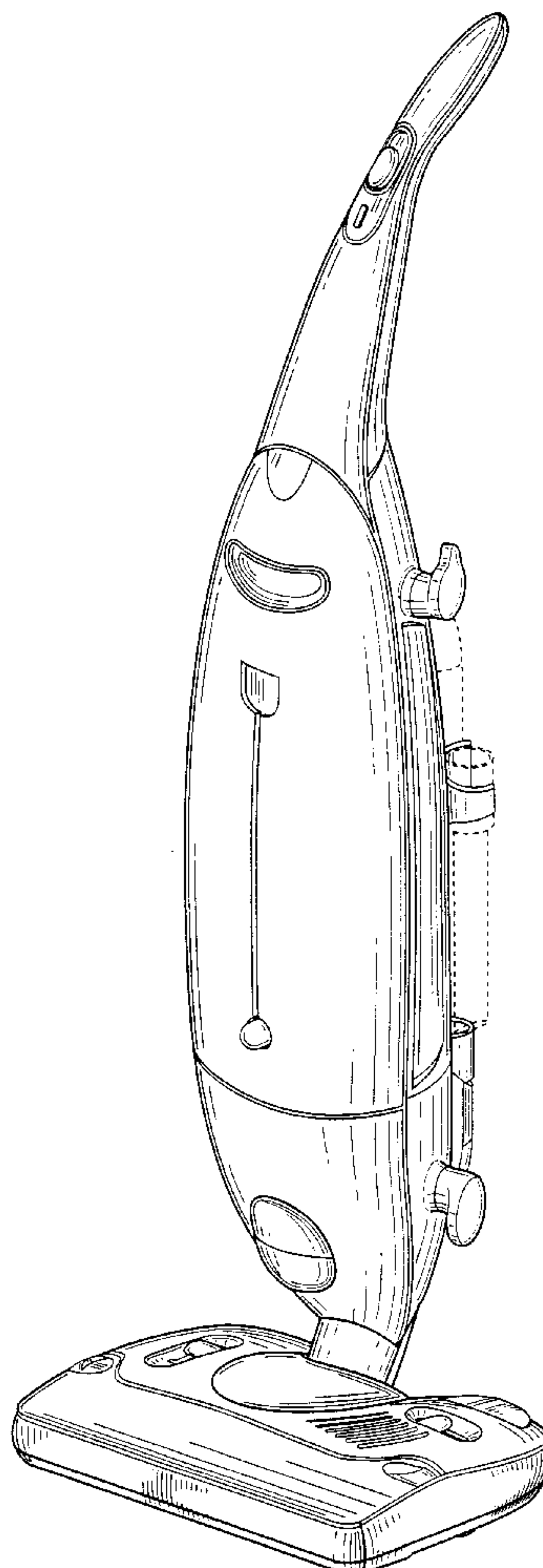

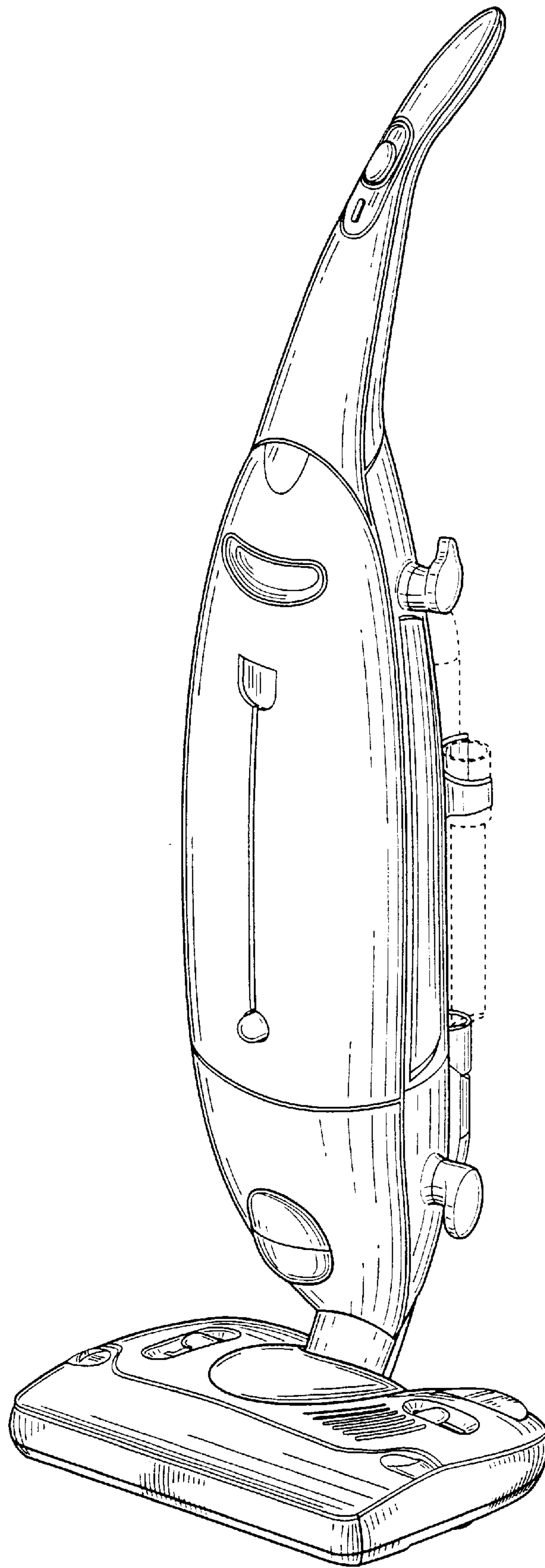

FIG. 1

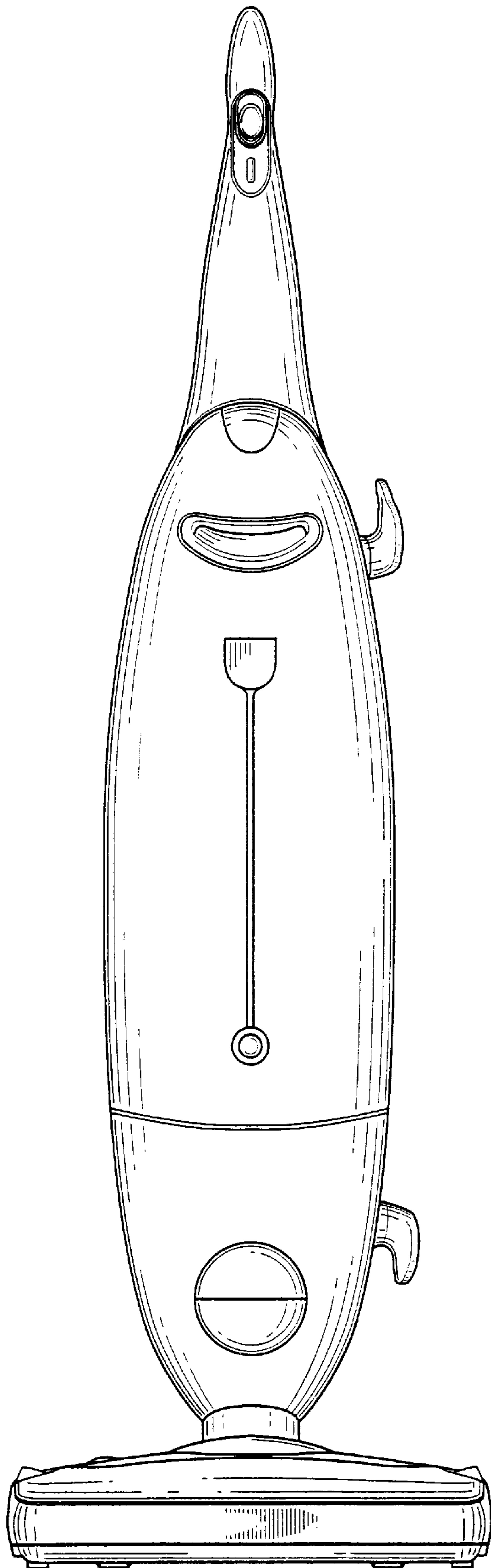

FIG. 2

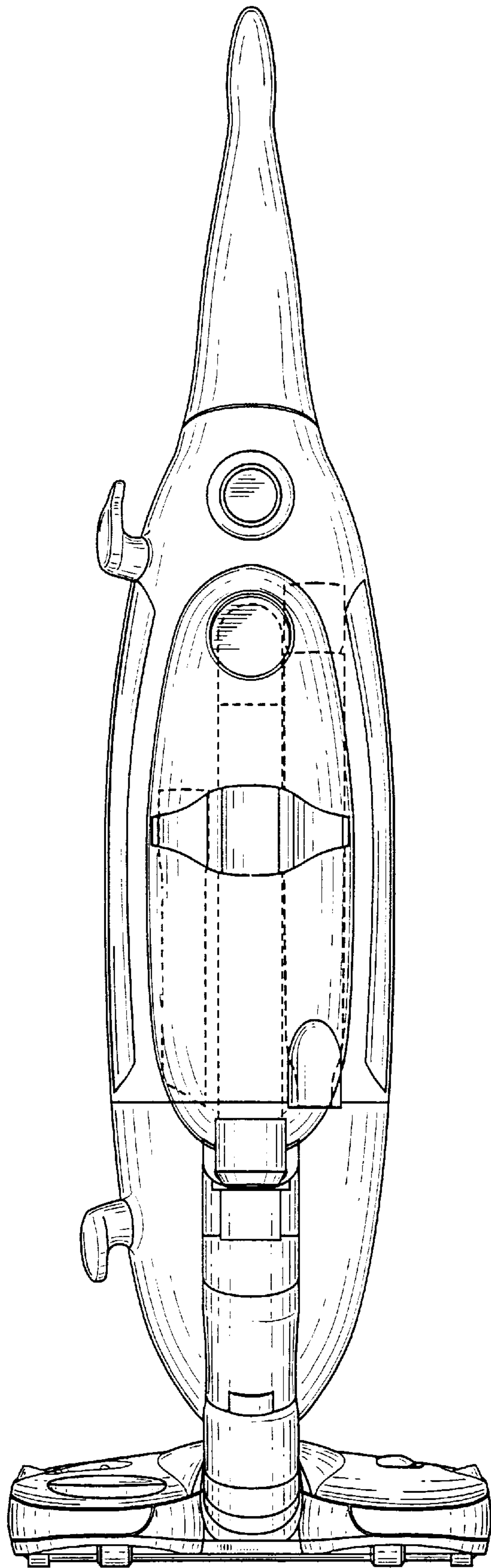

FIG. 3

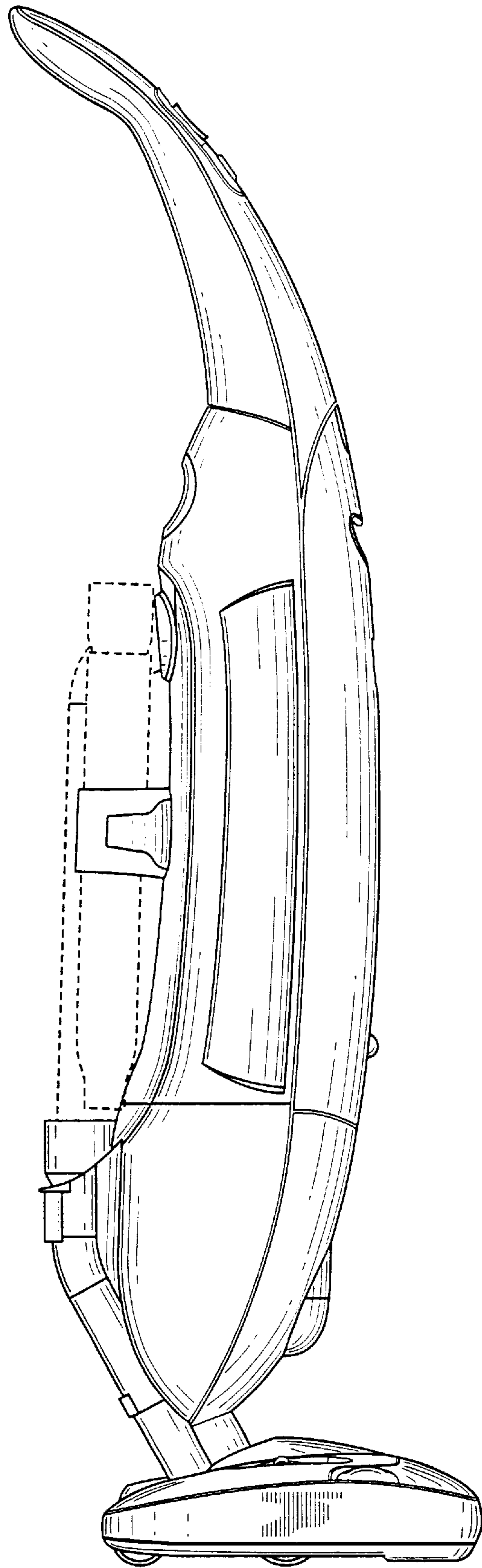

FIG. 4

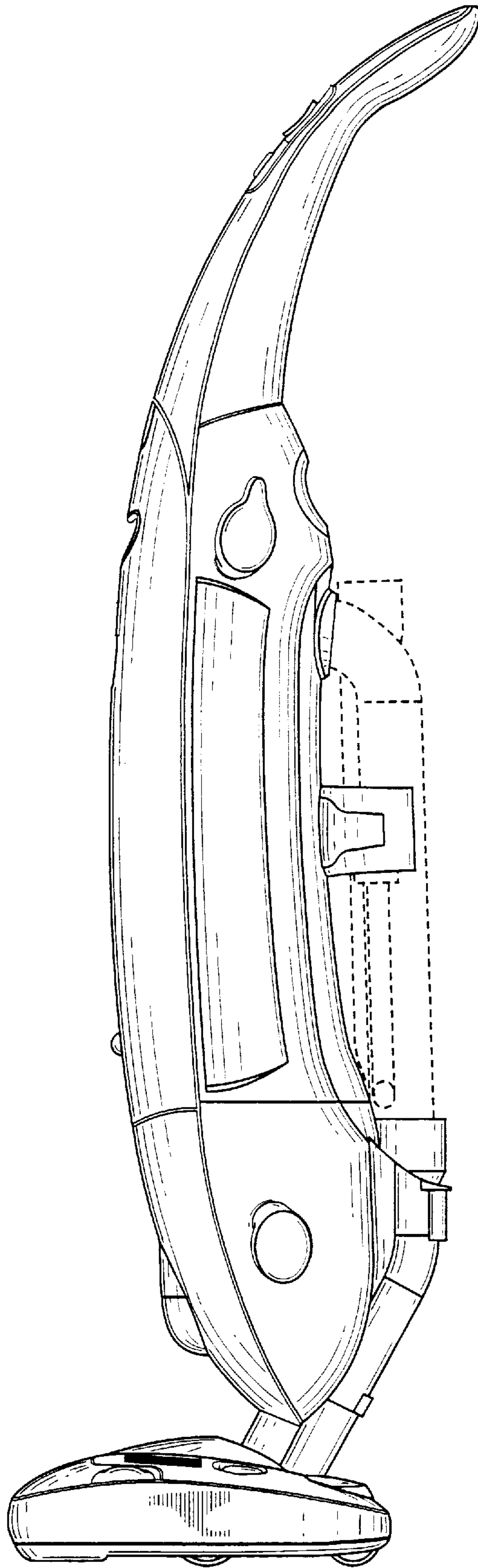

FIG. 5

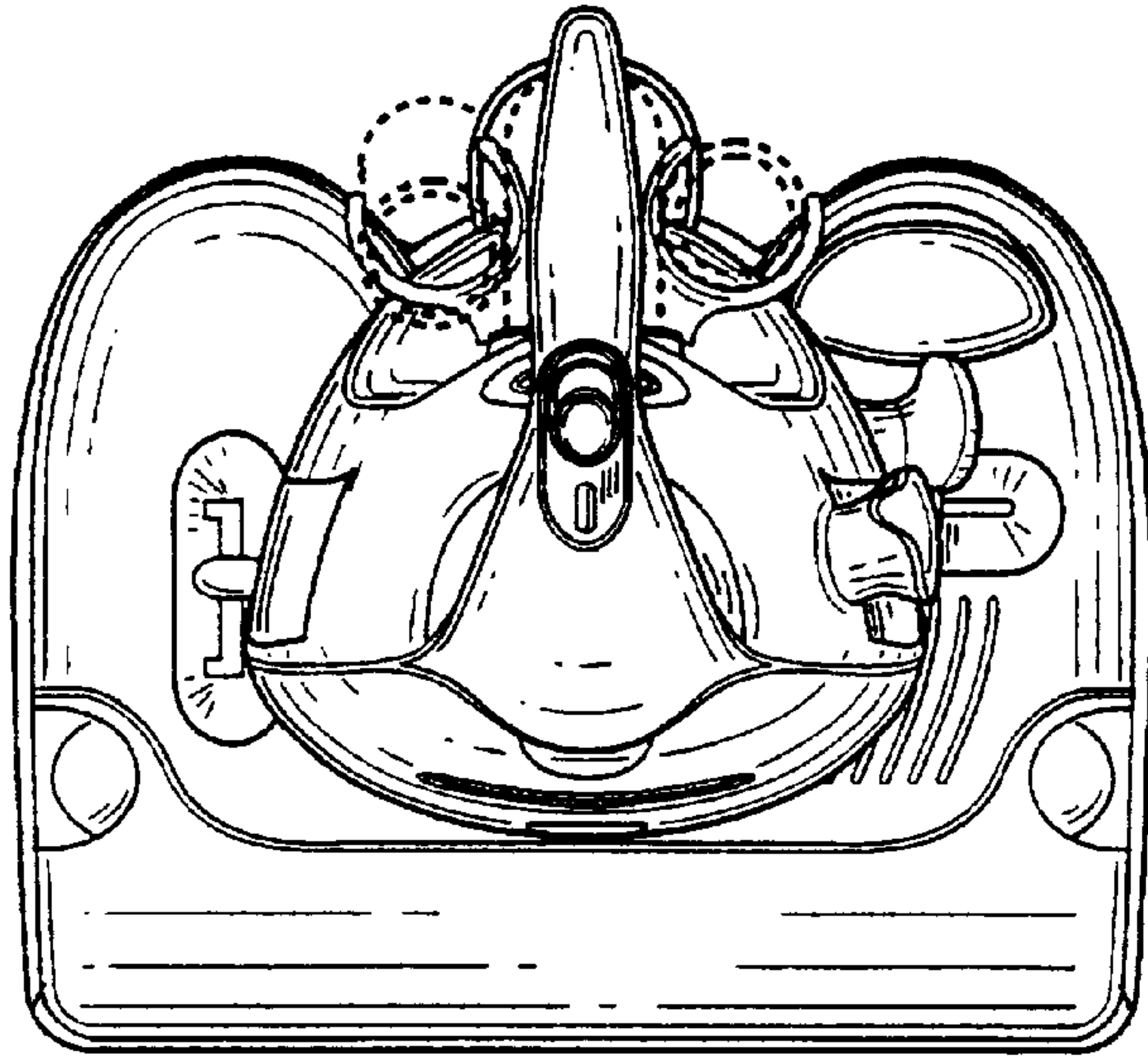

FIG. 6

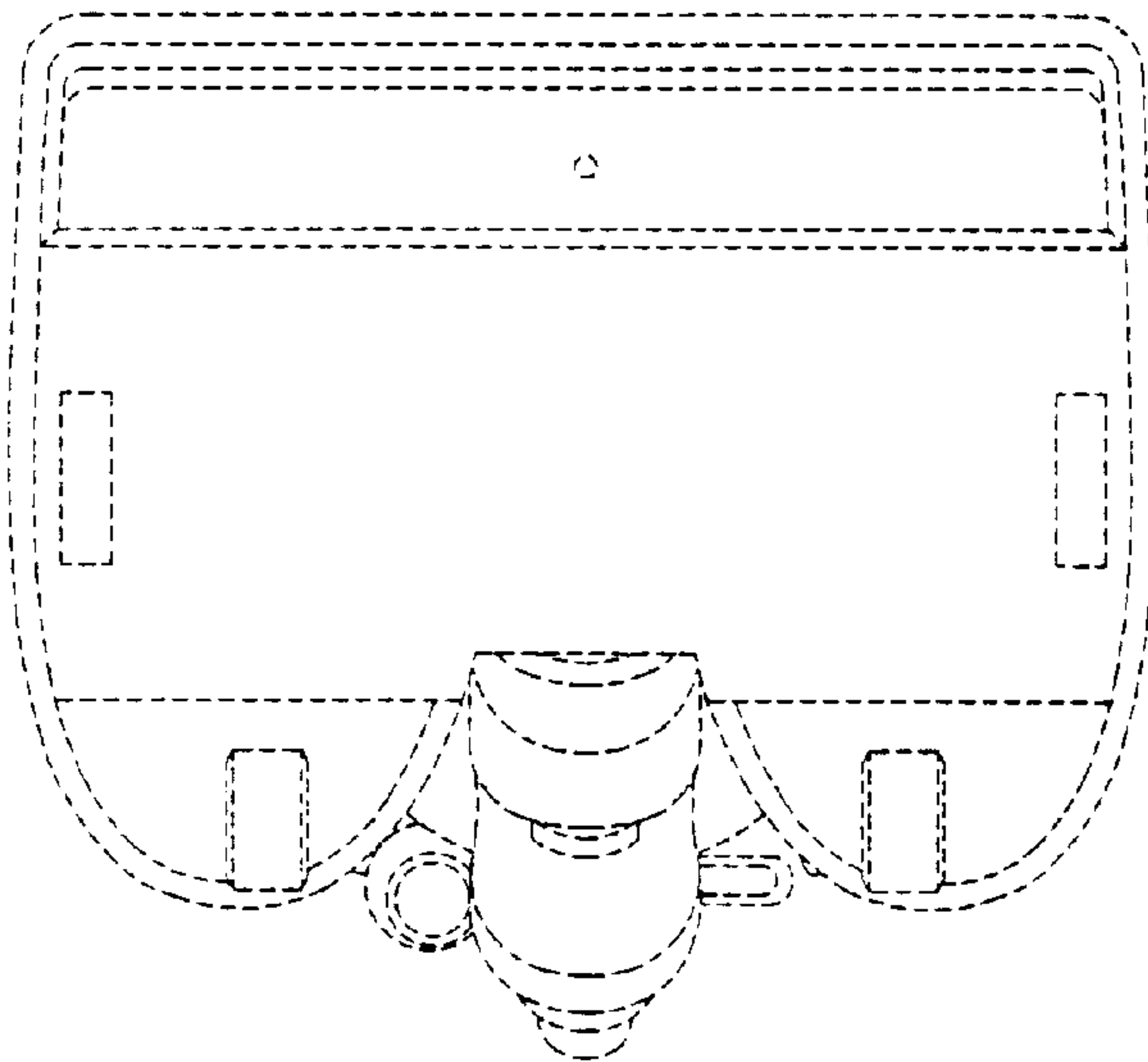

FIG. 7