



US00D419707S

United States Patent [19]
Tierney et al.

[11] **Patent Number: Des. 419,707**
[45] **Date of Patent: ** Jan. 25, 2000**

[54] **INSTRUMENT STAND FLOOR LAMP**

D. 392,123 3/1998 Lynch D6/466
D. 396,579 8/1998 Kalayjian D6/462

[76] Inventors: **Leonard J. Tierney**, 2330 Three Bridge Rd., Powhatan, Va. 23139; **Robert P. Tierney**, 7802 Lycoming Rd., Richmond, Va. 23229

OTHER PUBLICATIONS

George Kovacs lighting catalog, p. 45, floor lamp # 6000, 1987-1988.

[**] Term: **14 Years**

Primary Examiner—Susan J. Lucas
Attorney, Agent, or Firm—John F. Carroll, IV

[21] Appl. No.: **29/091,682**

[57] **CLAIM**

[22] Filed: **Aug. 4, 1998**

The ornamental design for a instrument stand floor lamp, as shown.

[51] **LOC (7) Cl.** **26-05**

DESCRIPTION

[52] **U.S. Cl.** **D26/51; D6/462; D26/106**

FIG. 1 shows a front elevation view of the invention;
FIG. 2 shows a left side elevation view of the invention;
FIG. 3 shows a right side elevation view of the invention;
FIG. 4 shows a perspective view of the invention;
FIG. 5 shows a top view of the invention;
FIG. 6 shows a detail of the lower part of the invention; and,
FIG. 7 shows a detail of the top support of the invention.

[58] **Field of Search** D26/93, 102-112,
D26/51, 56; 362/410-414, 253, 806; D6/399,
431, 462, 465, 486, 487; D17/99; 248/146,
163.1, 176.1, 443, 441

[56] **References Cited**

U.S. PATENT DOCUMENTS

D. 127,028 5/1941 Warren D26/399
D. 236,227 8/1975 Kester, Jr. D6/431

1 Claim, 7 Drawing Sheets

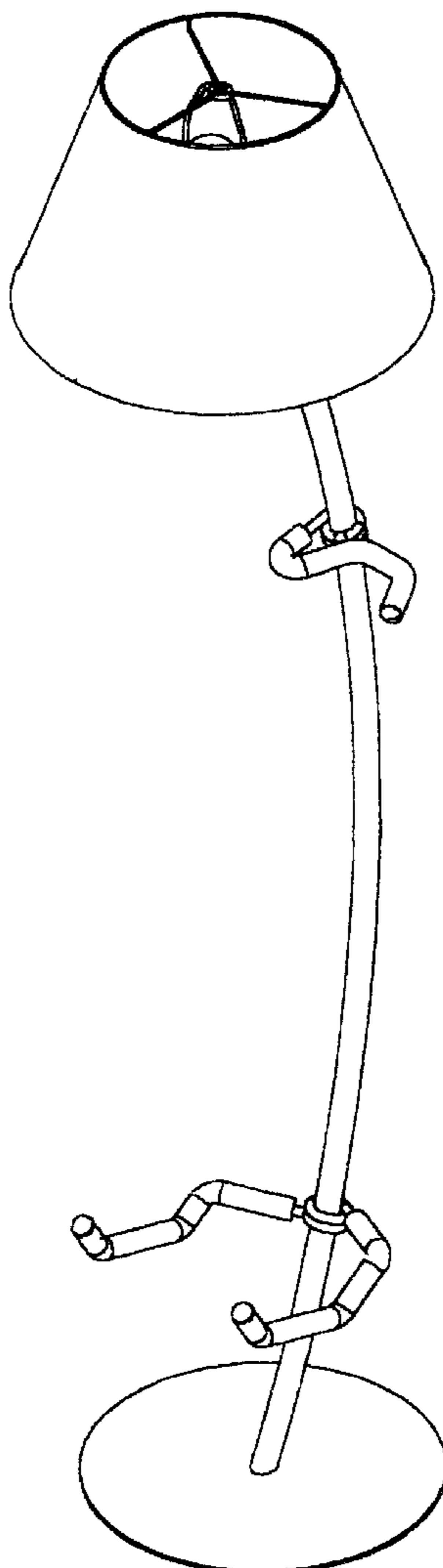

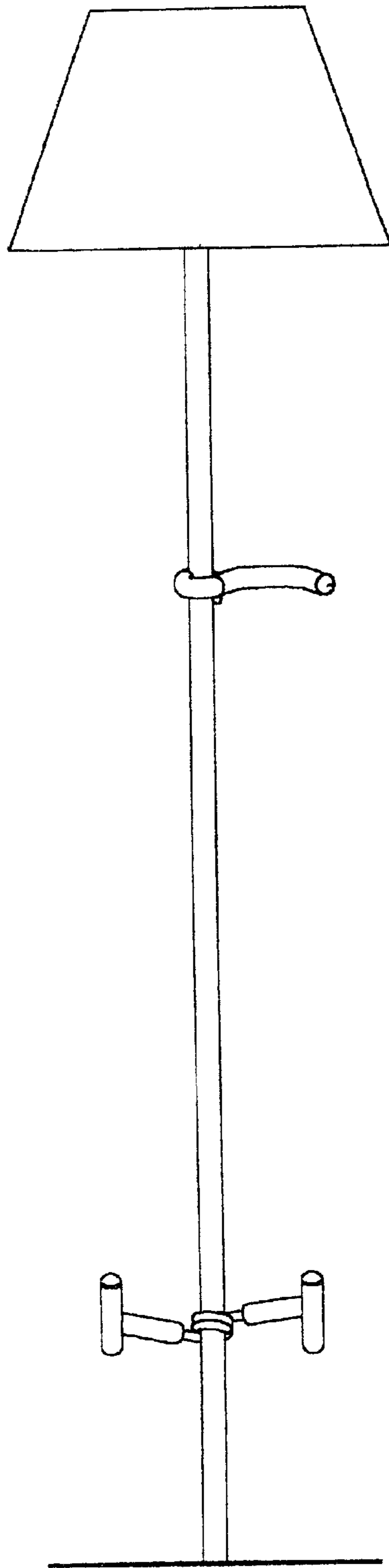

FIG. 1

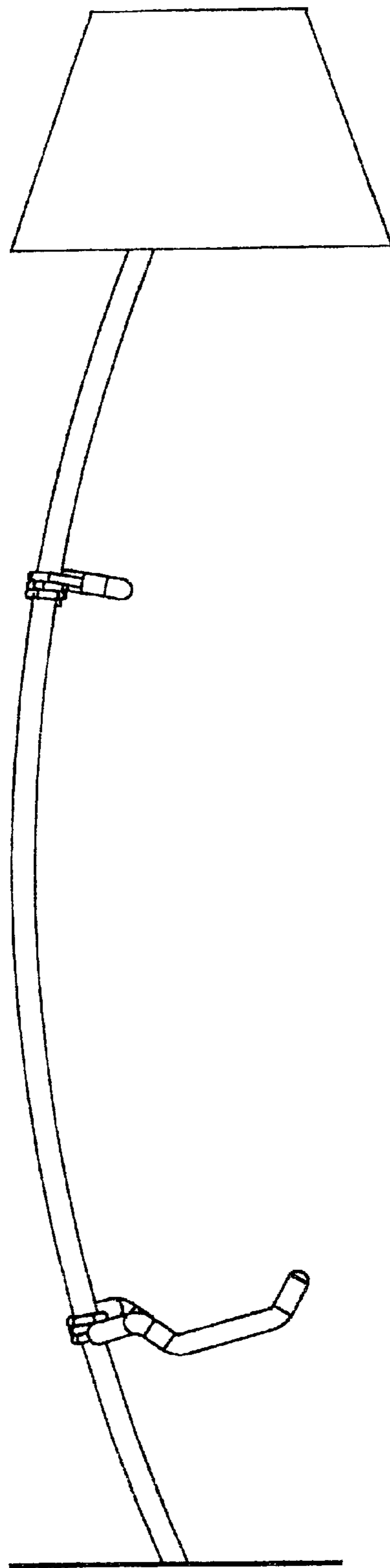

FIG. 2

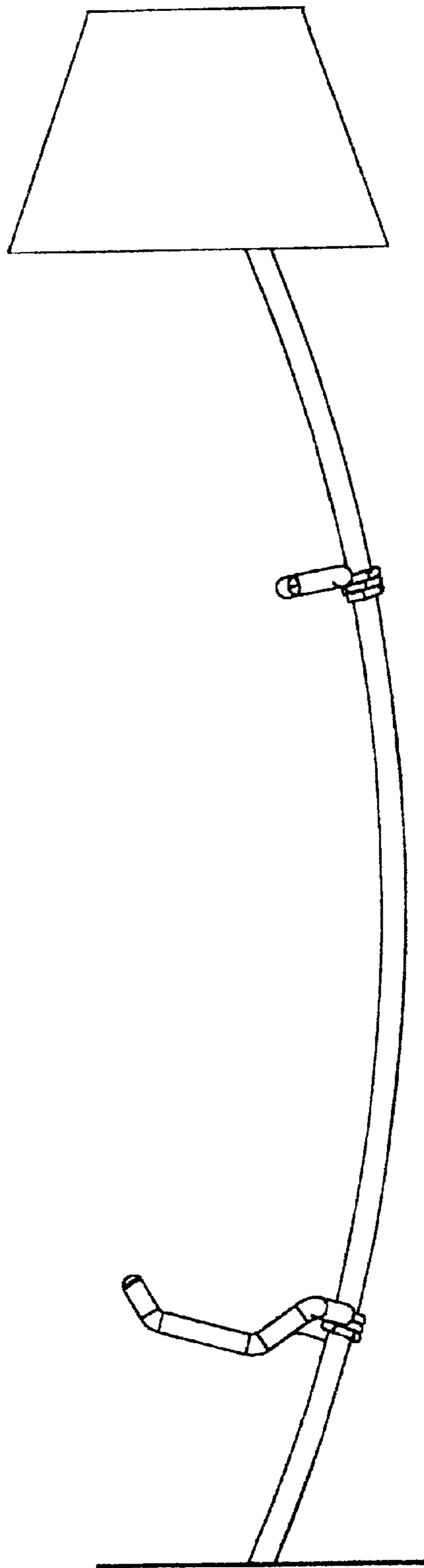

FIG. 3

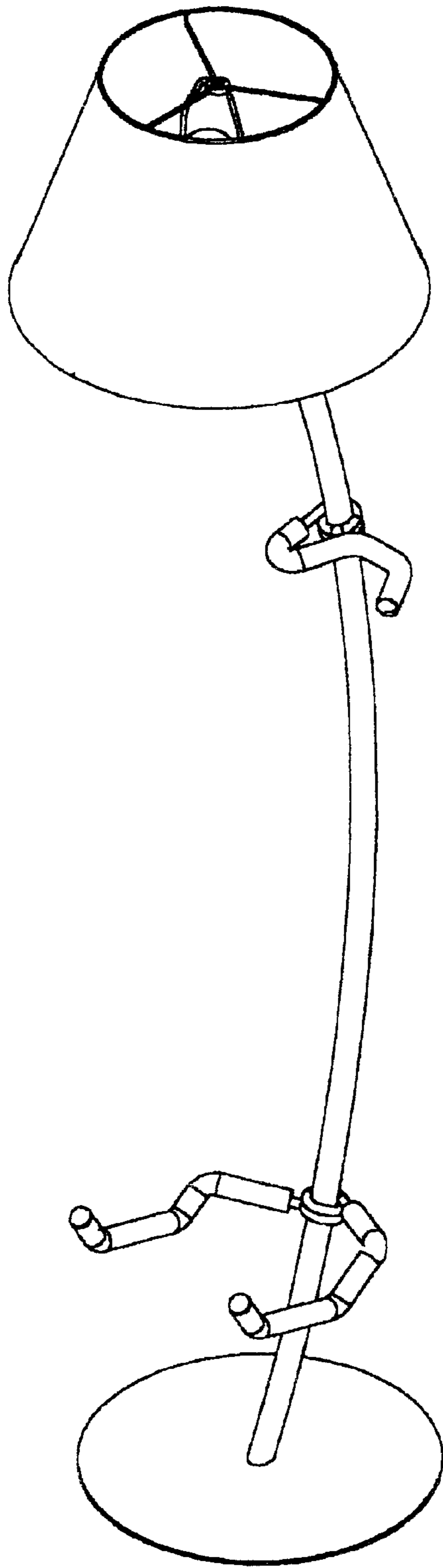

FIG. 4

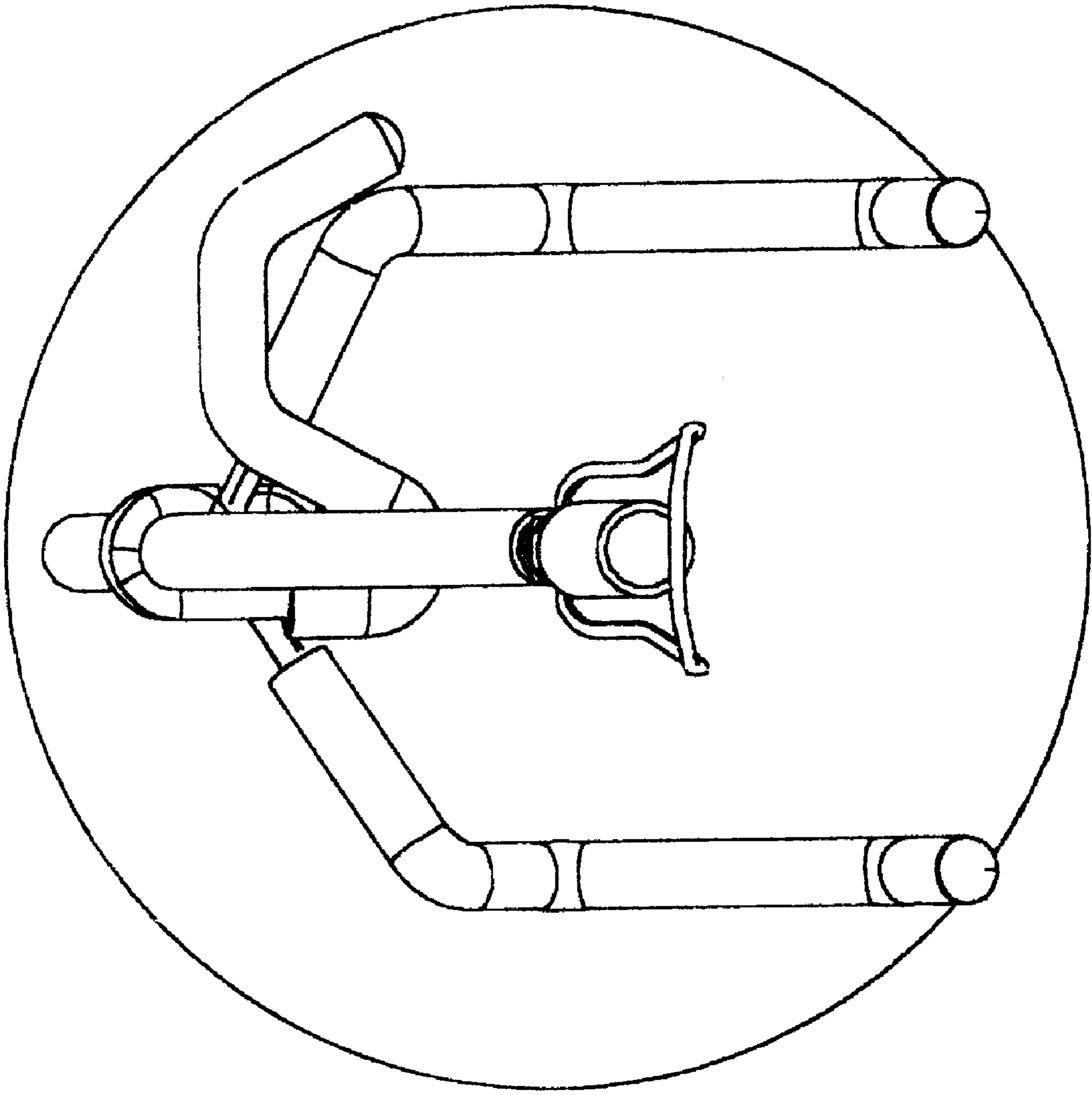

FIG. 5

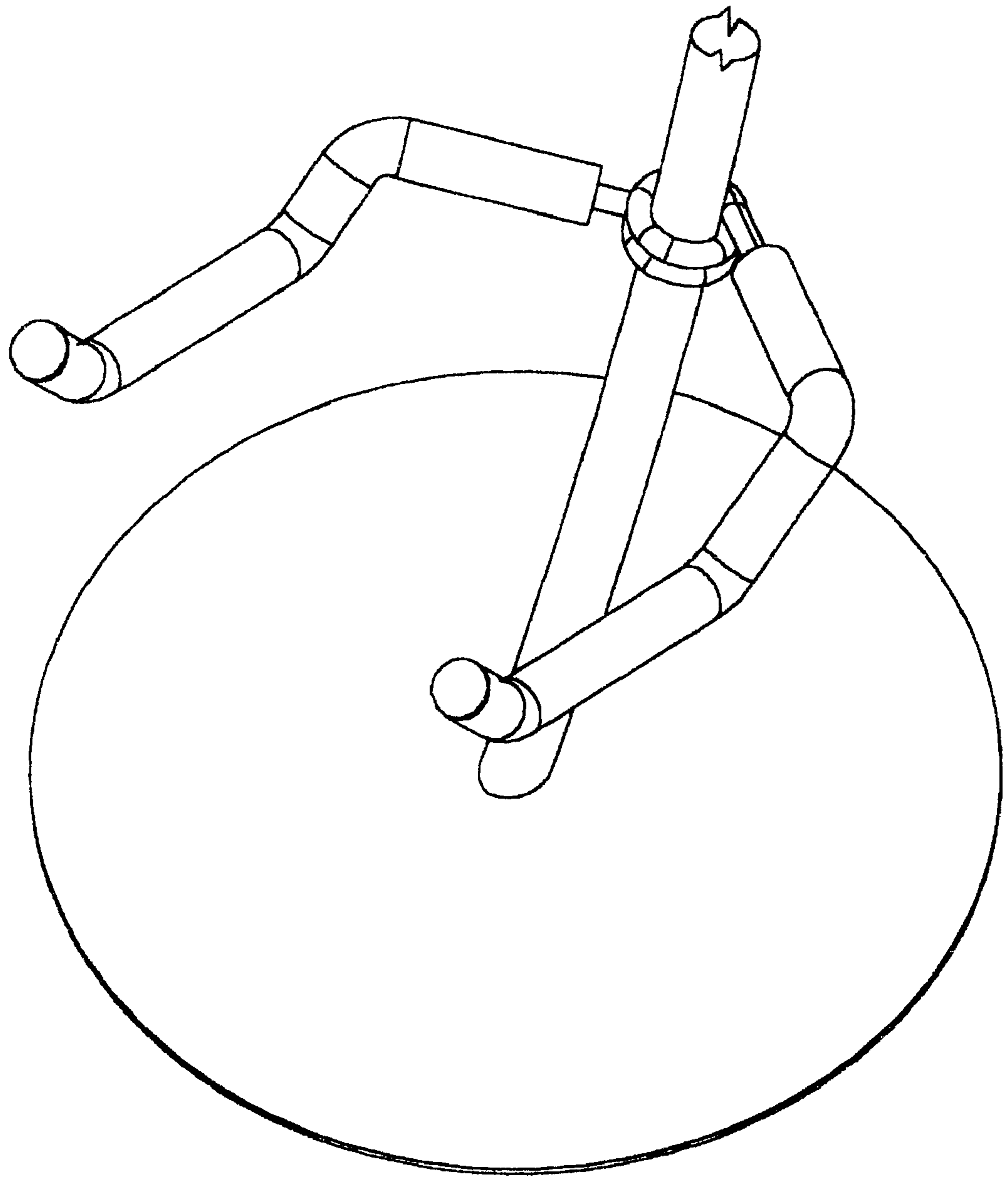

FIG. 6

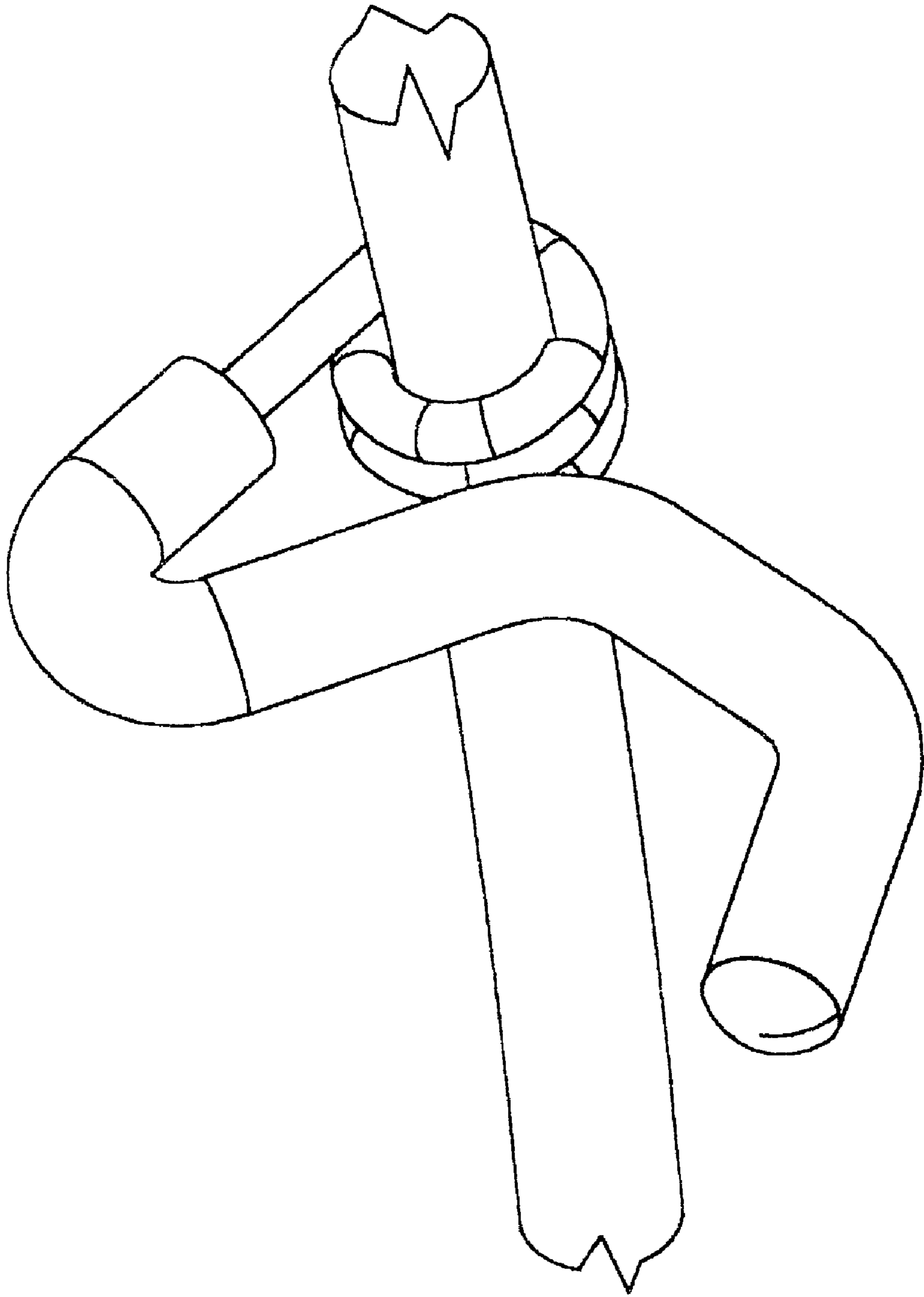

FIG. 7