



US00D419599S

United States Patent [19] Mak

[11] **Patent Number: Des. 419,599**

[45] **Date of Patent: ** Jan. 25, 2000**

[54] **TOY DRAWING BOARD**

[75] Inventor: **Kai-Shun Mak**, Kwai Chung, The Hong Kong Special Administrative Region of the People's Republic of China

[73] Assignee: **Hop Lee Cheong Industrial Company Ltd.**, The Hong Kong Special Administrative Region of the People's Republic of China

[**] Term: **14 Years**

[21] Appl. No.: **29/099,626**

[22] Filed: **Jan. 25, 1999**

[51] **LOC (7) Cl.** **19-06**

[52] **U.S. Cl.** **D19/52; D19/35; D21/398**

[58] **Field of Search** **D21/398; D19/35, D19/36, 52, 65, 86, 88, 90, 91, 99, 100; 434/81, 84, 85, 87, 88, 90, 91, 98, 408, 415, 416, 422**

D. 327,498 6/1992 Watson et al. D19/52
D. 356,823 3/1995 Tarozzi D19/52 X
5,562,452 10/1996 Atugi et al. 434/85
5,676,549 10/1997 Arad et al. 434/84

Primary Examiner—Martie K. Holtje
Attorney, Agent, or Firm—Samuels, Gauthier & Stevens

[57] **CLAIM**

The ornamental design for a “a toy drawing board”, as shown and described.

DESCRIPTION

FIG. 1 is the front perspective view showing my new design;
FIG. 2 is the front view thereof;
FIG. 3 is the rear view thereof;
FIG. 4 is the left-hand view thereof;
FIG. 5 is the right-hand view thereof;
FIG. 6 is the top view thereof; and,
FIG. 7 is the bottom view thereof.

[56] **References Cited**

U.S. PATENT DOCUMENTS

D. 174,015 2/1955 Bosma D19/52

1 Claim, 3 Drawing Sheets

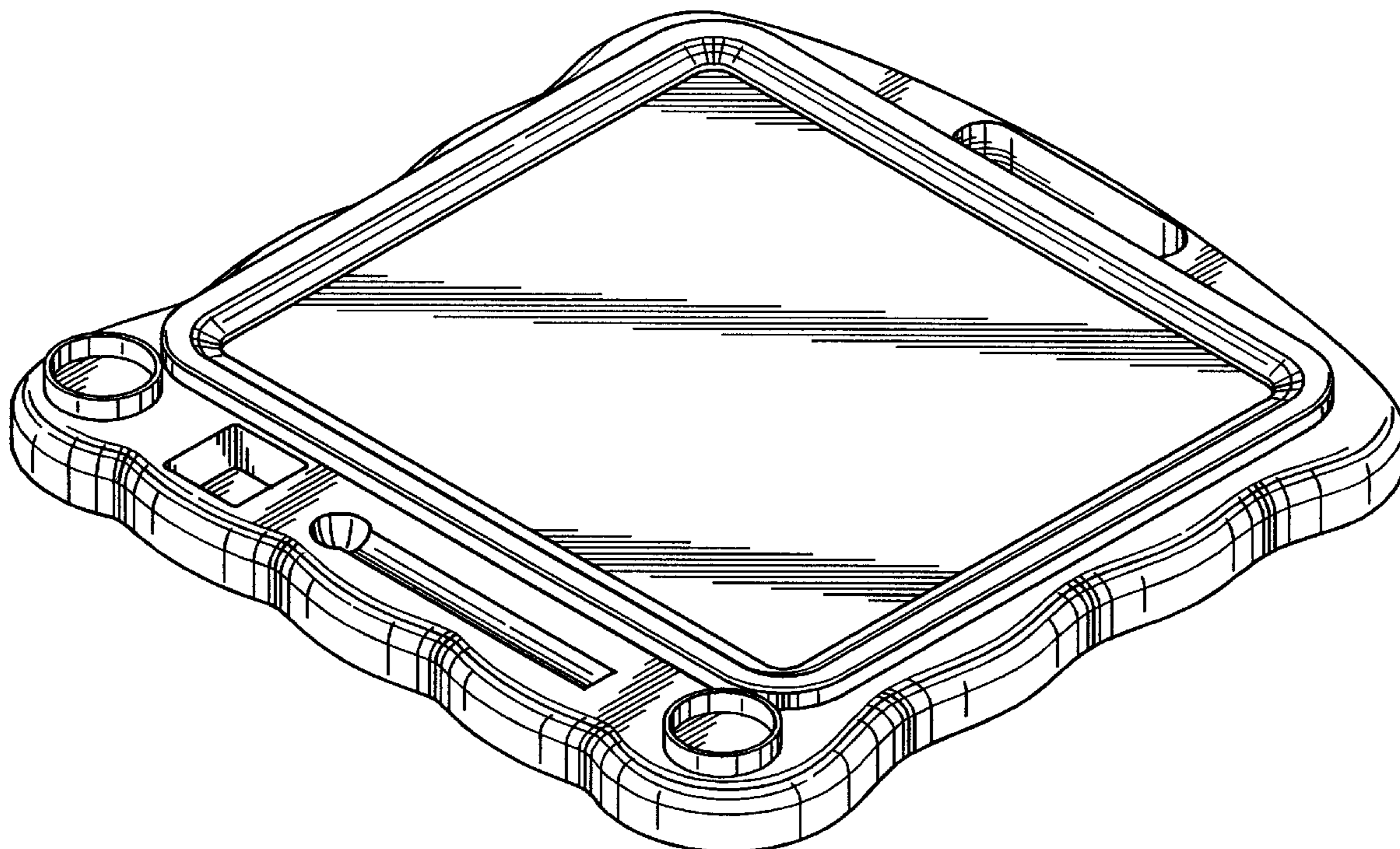

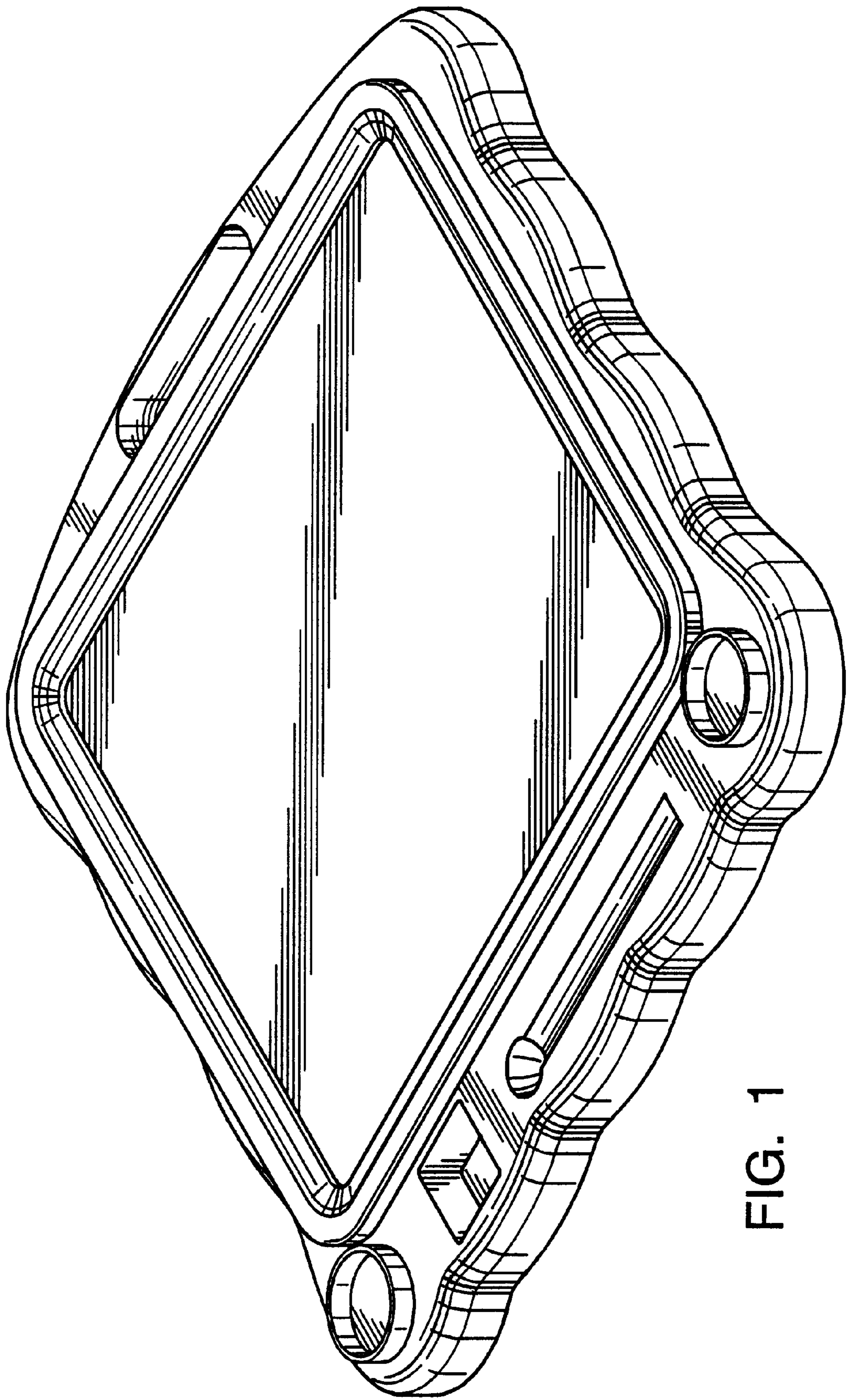

FIG. 1

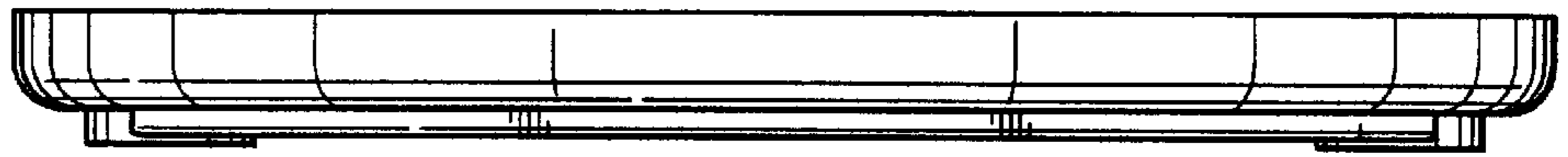

FIG. 4

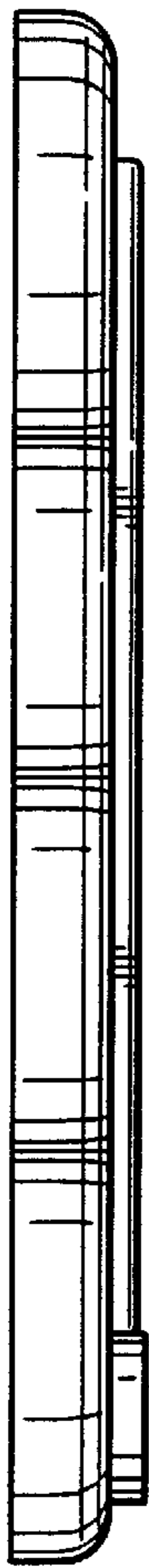

FIG. 3

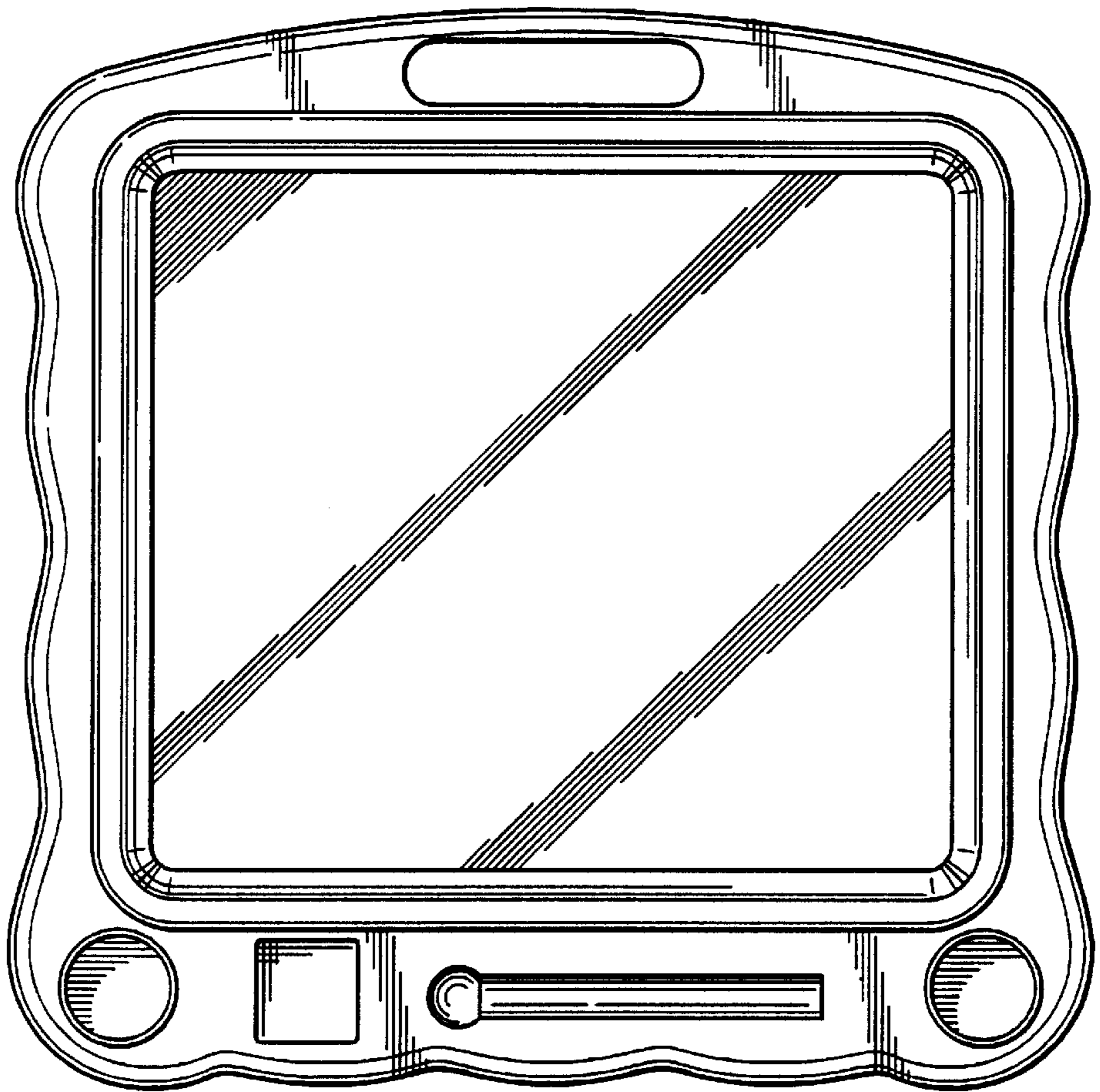

FIG. 2

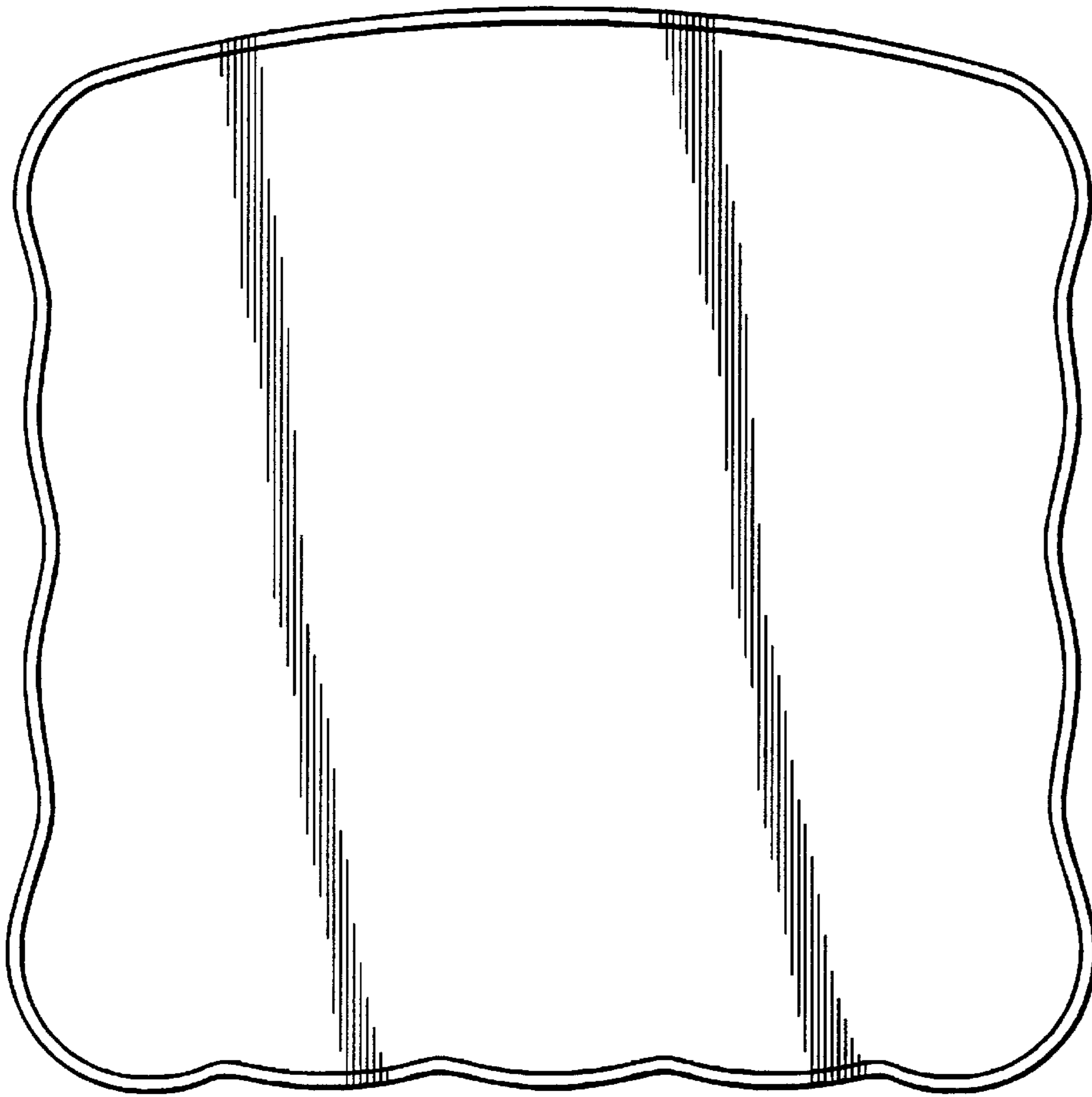

FIG. 5

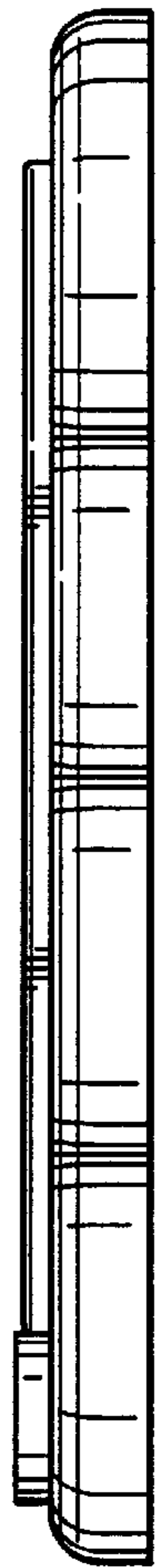

FIG. 6

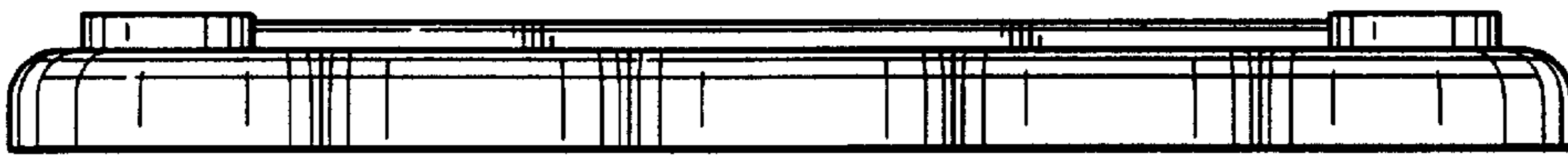

FIG. 7