



US00D419573S

United States Patent [19]

Kawahara et al.

[11] Patent Number: **Des. 419,573**

[45] Date of Patent: **** Jan. 25, 2000**

[54] **LASER BEAM MACHINE**

5,854,460 12/1998 Graf et al. 219/121.67

[75] Inventors: **Kenta Kawahara; Tsukasa Matsuno,**
both of Tokyo, Japan

FOREIGN PATENT DOCUMENTS

62-282794 12/1987 Japan .
8-309569 11/1996 Japan .

[73] Assignee: **Mitsubishi Denki Kabushiki Kaisha,**
Tokyo, Japan

[**] Term: **14 Years**

Primary Examiner—Antoine Duval Davis
Attorney, Agent, or Firm—Oblon, Spivak, McClelland,
Maier & Neustadt, P.C.

[21] Appl. No.: **29/100,885**

[57] CLAIM

[22] Filed: **Feb. 19, 1999**

The ornamental design for laser beam machine, as shown
and described.

[30] Foreign Application Priority Data

Oct. 14, 1998 [JP] Japan 10-29640

DESCRIPTION

[51] **LOC (7) Cl.** **15-09**

[52] **U.S. Cl.** **D15/122**

[58] **Field of Search** D10/40, 75; D15/122;
219/121.7, 121.71, 121.79, 121.6, 121.67,
121.78, 121.84, 121.73, 121.82, 121.61,
121.62; 364/474.08; 372/99, 9, 19, 29,
92, 107-109

FIG. 1 is a front elevational view of a laser beam machine,
showing our new design;
FIG. 2 is a top plan view thereof;
FIG. 3 is a rear elevational view thereof;
FIG. 4 is a bottom plan view thereof;
FIG. 5 is a right side elevational view thereof;
FIG. 6 is a left side elevational view thereof; and,
FIG. 7 is a front, top and left side perspective view thereof.

[56] References Cited

U.S. PATENT DOCUMENTS

D. 332,615 1/1993 Fang et al. D15/122

1 Claim, 4 Drawing Sheets

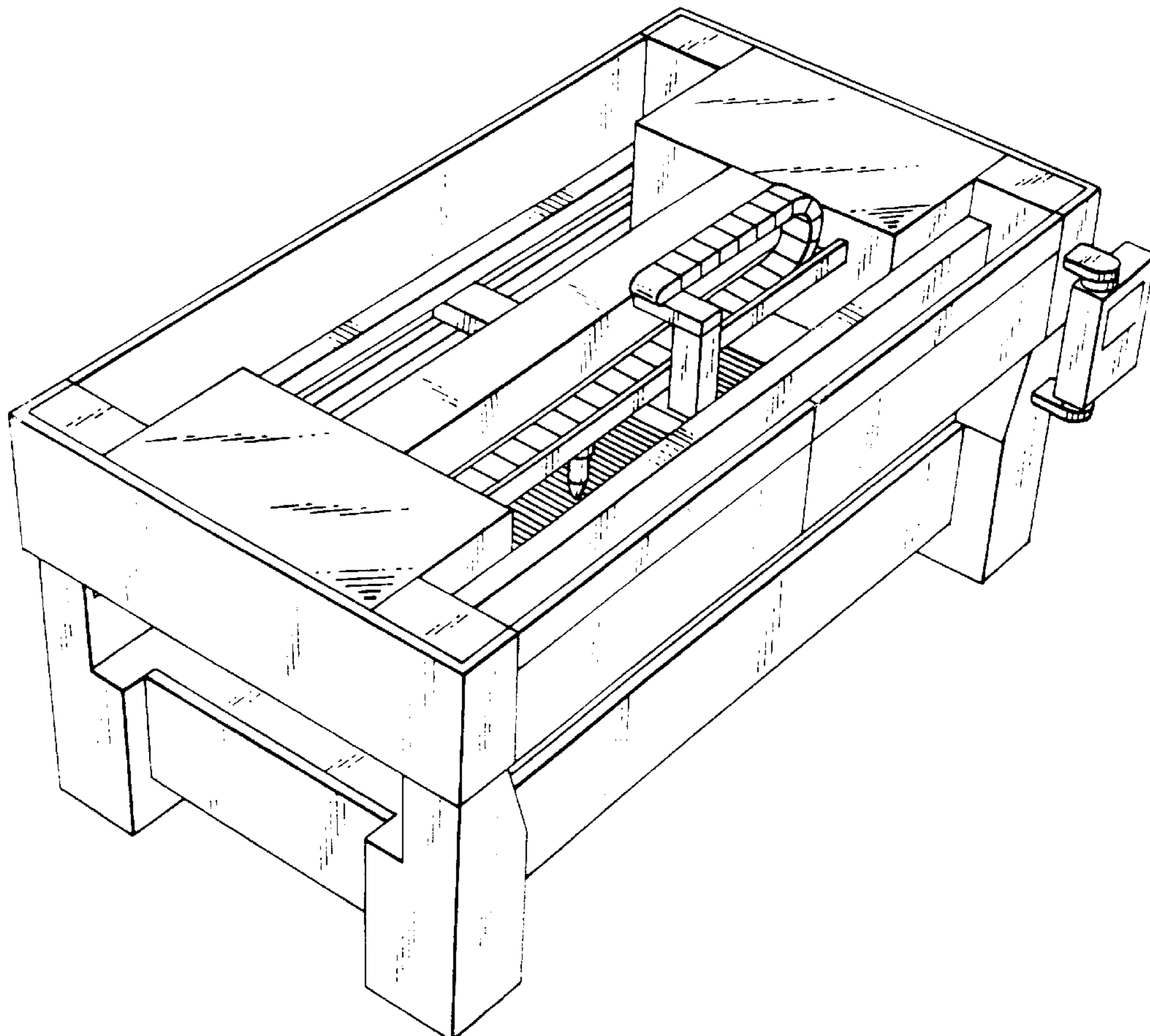

FIG. 1

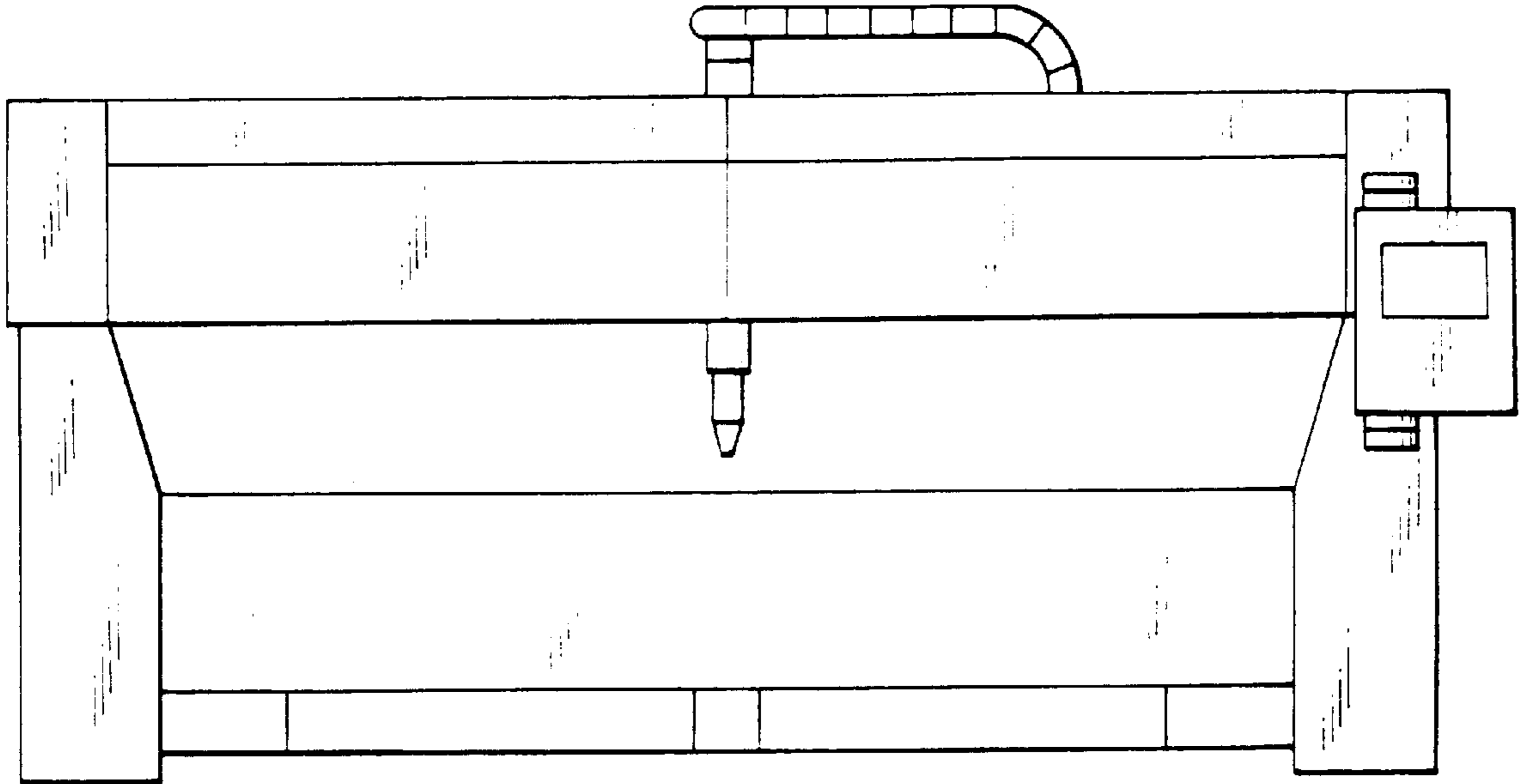

FIG. 2

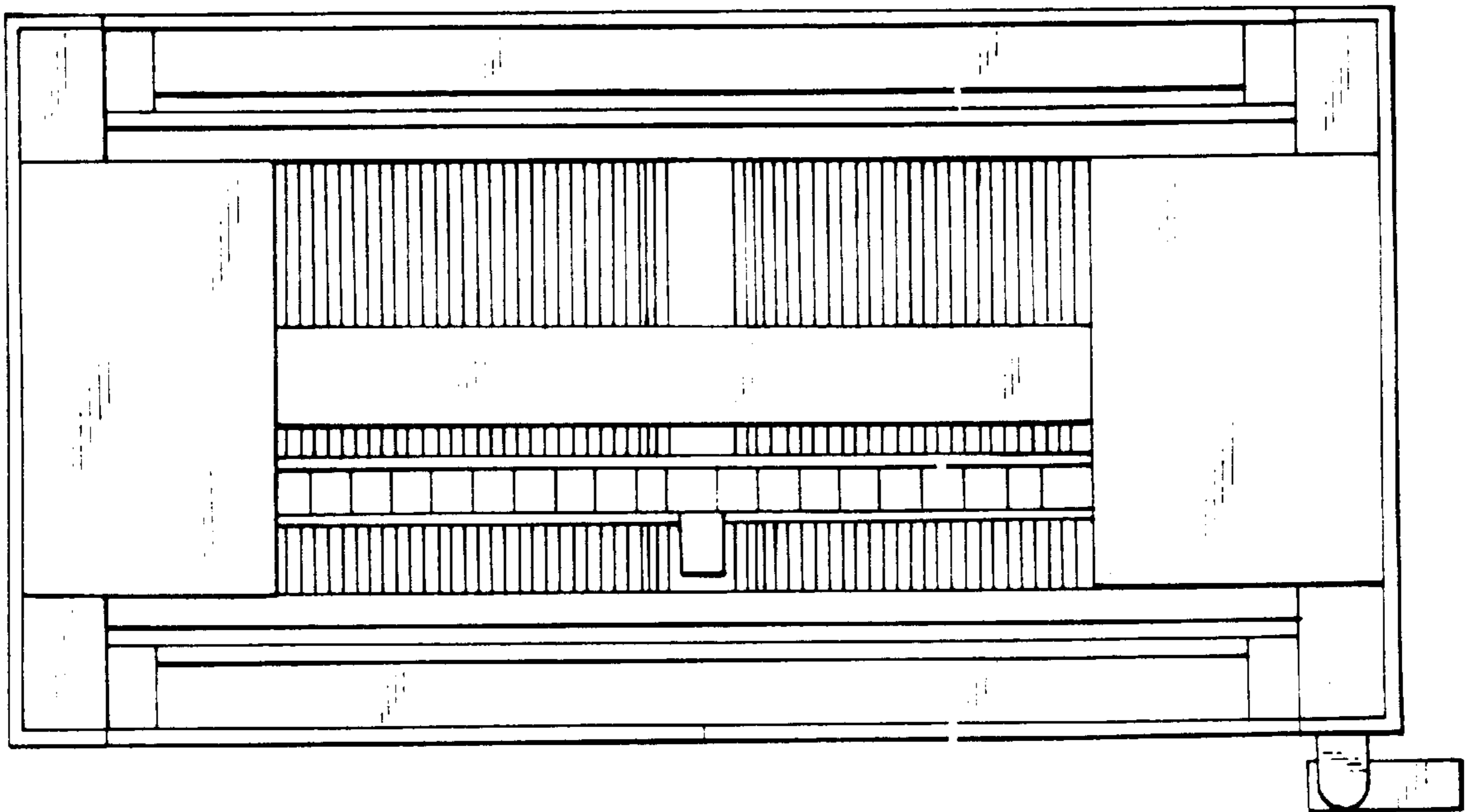

FIG. 3

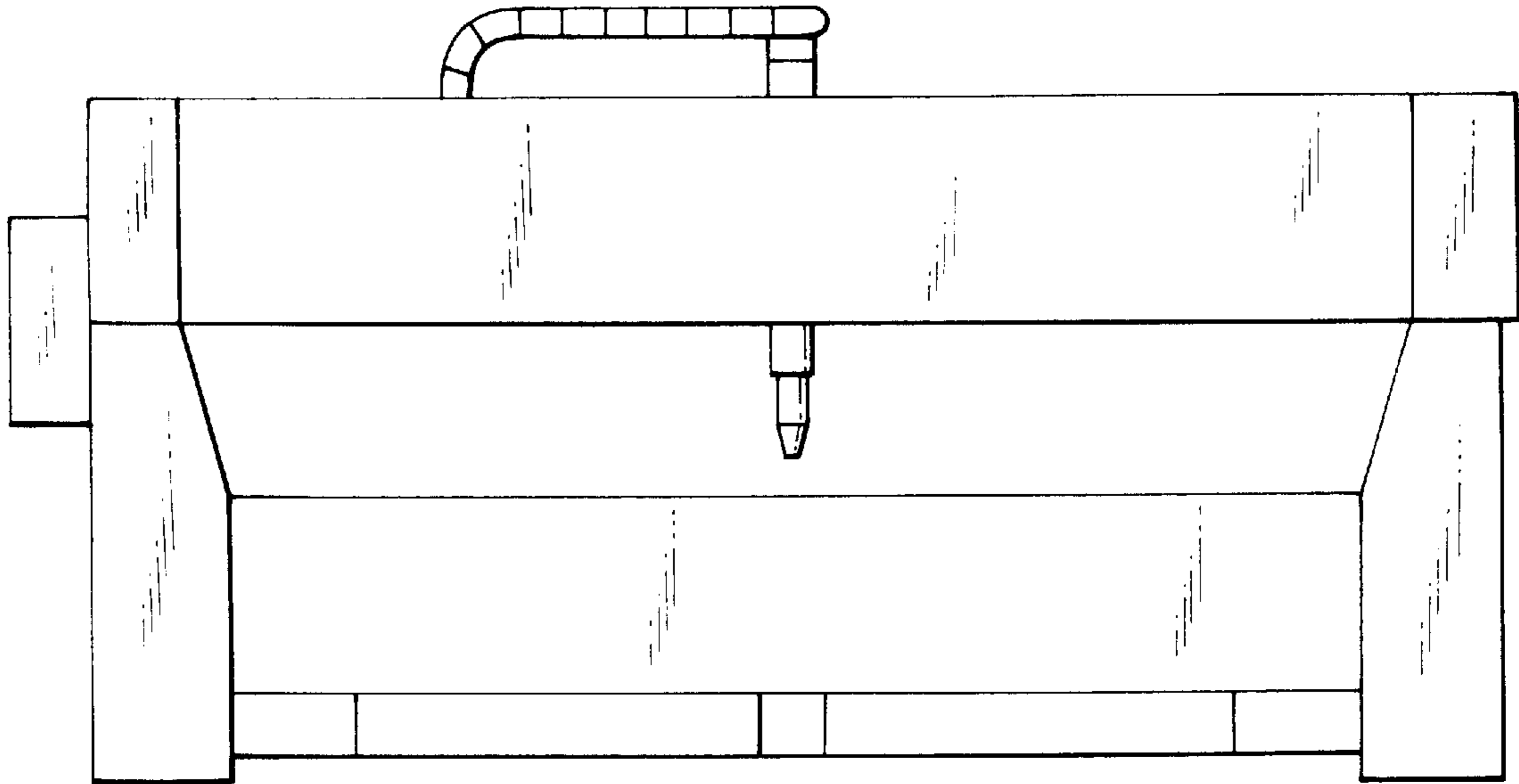

FIG. 4

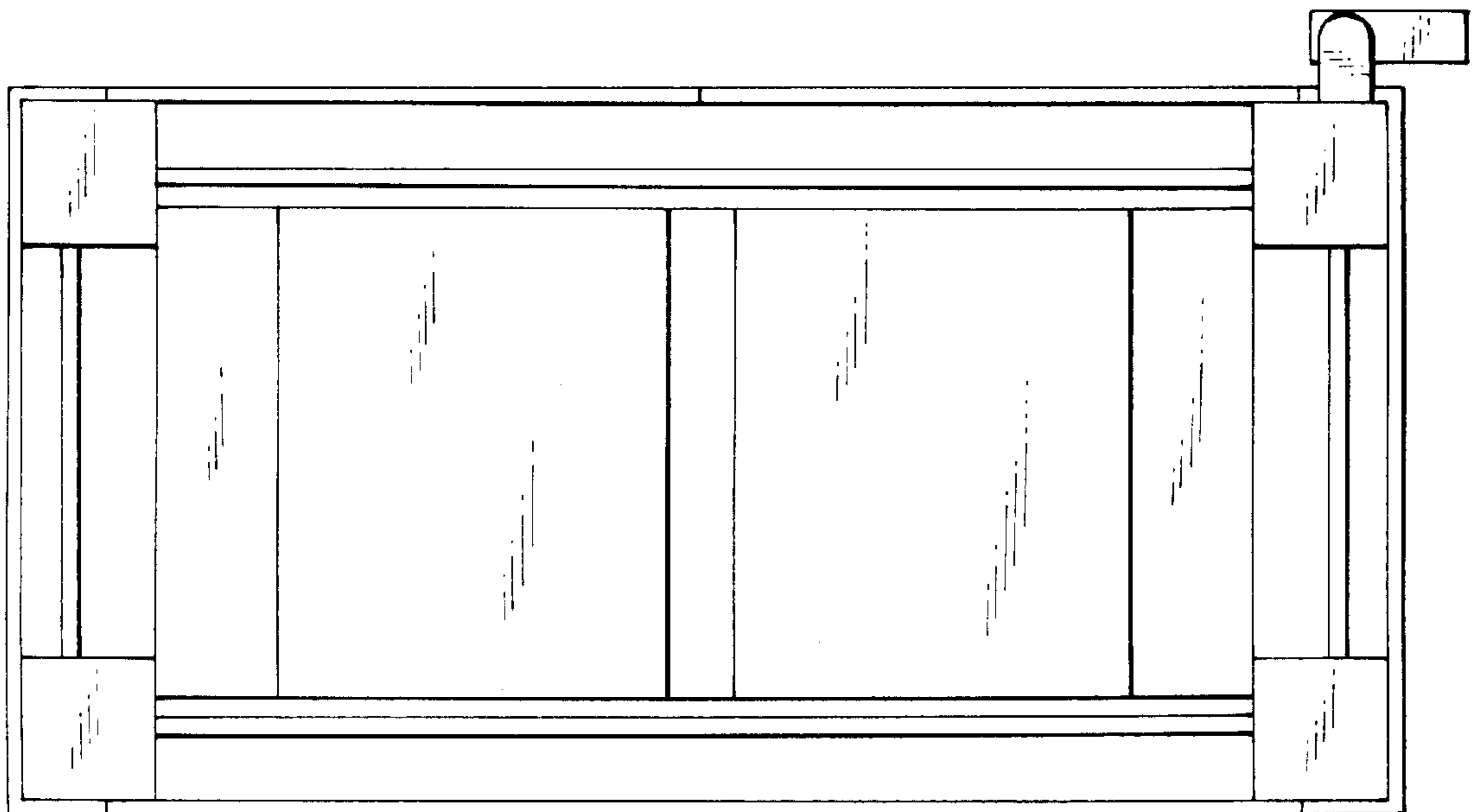

FIG. 5

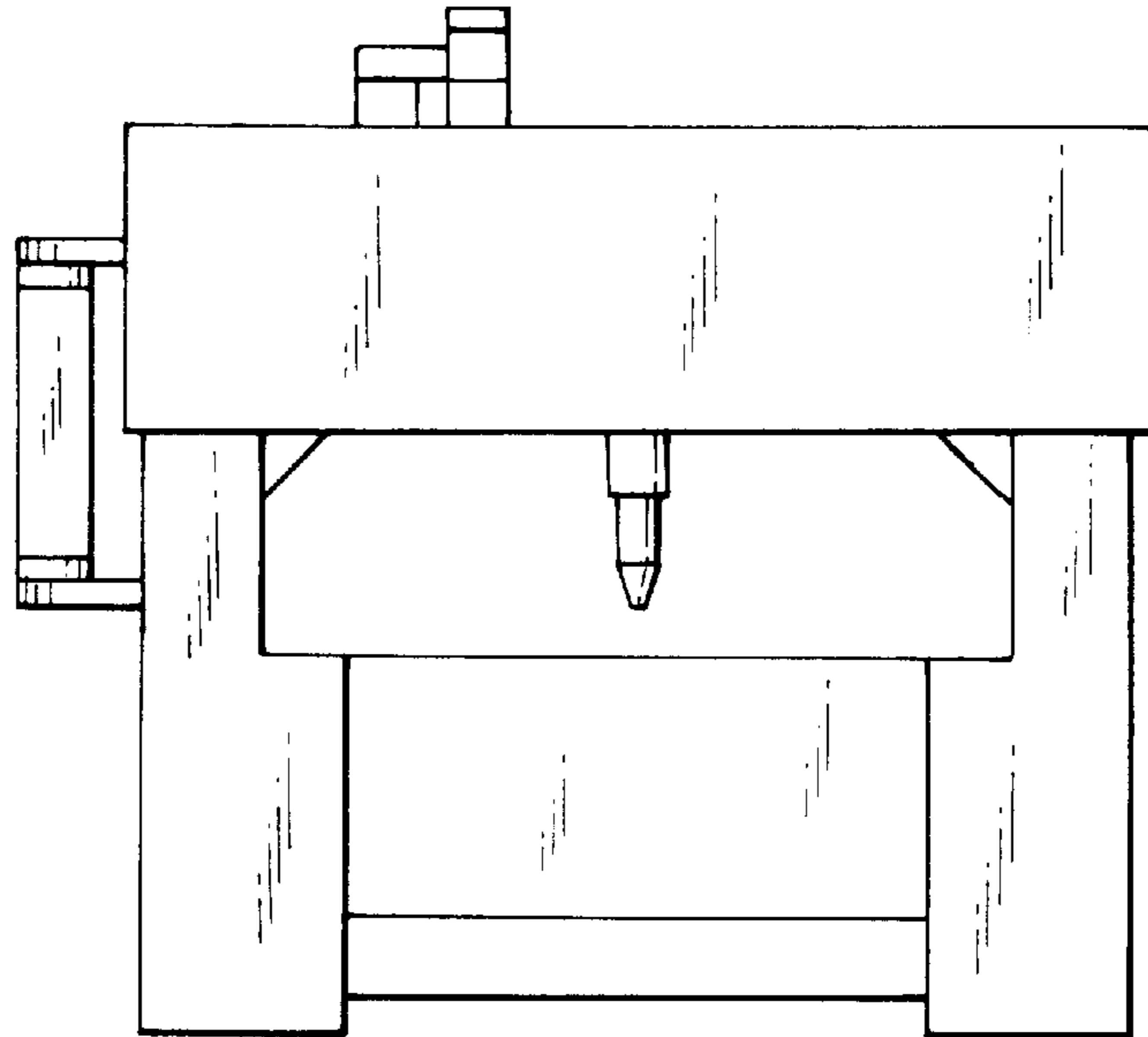

FIG. 6

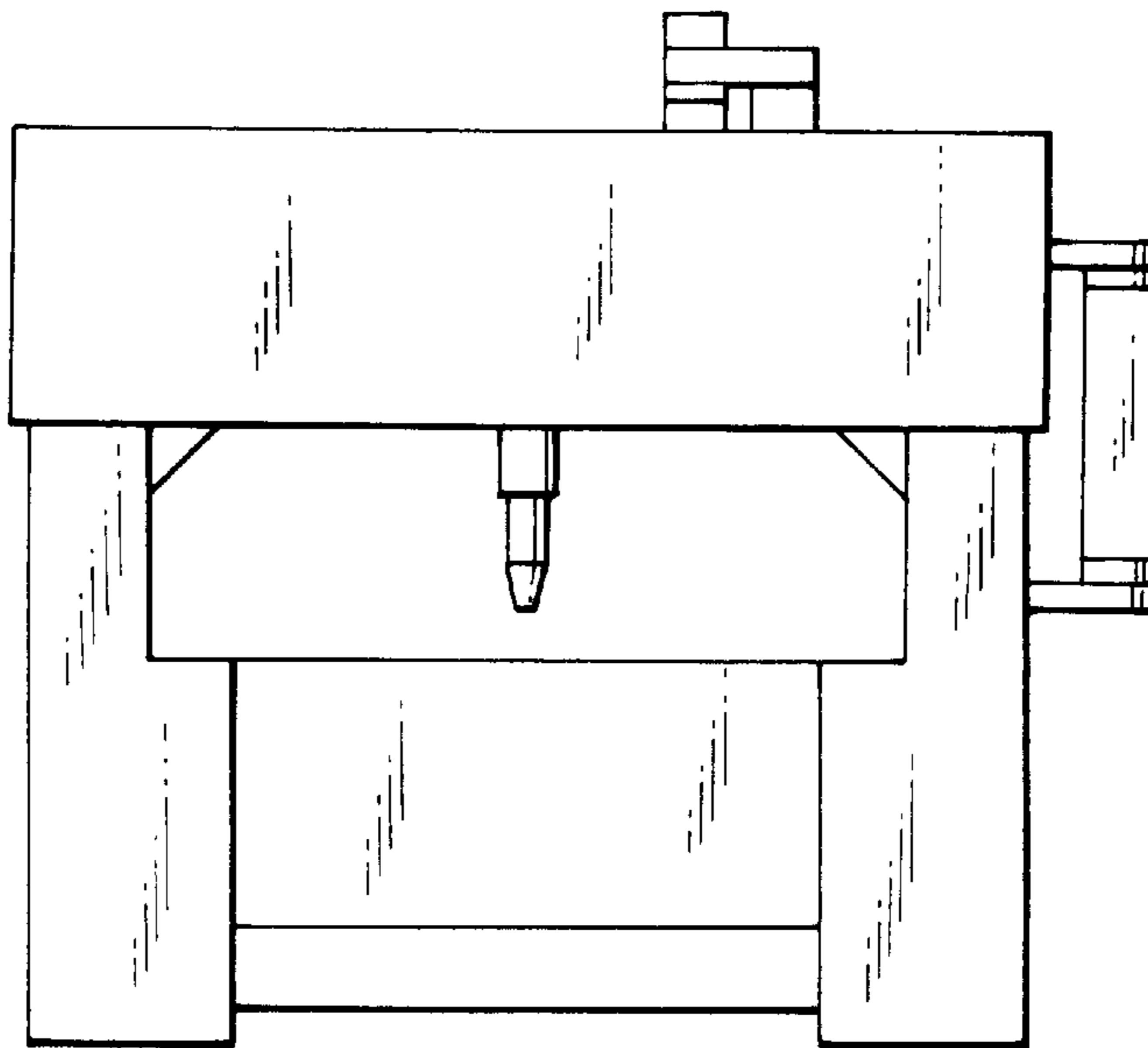

FIG. 7

