



US00D419488S

United States Patent [19]

[11] Patent Number: **Des. 419,488**

Sacco et al.

[45] Date of Patent: **** Jan. 25, 2000**

[54] **SURFACE CONFIGURATION OF A VEHICLE BODY**

Primary Examiner—Melody N. Brown
Attorney, Agent, or Firm—Evenson, McKeown, Edwards & Lenahan, P.L.L.C.

[75] Inventors: **Bruno Sacco**, Sindelfingen; **Peter Pfeiffer**, Boeblingen, both of Germany

[57] **CLAIM**

[73] Assignee: **DaimlerChrysler AG**, Germany

The ornamental design for a surface configuration of a vehicle body, as shown and described.

[**] Term: **14 Years**

DESCRIPTION

[21] Appl. No.: **29/099,448**

FIG. 1 is a front view of a surface configuration of a vehicle body according to our novel design;

[22] Filed: **Jan. 21, 1999**

FIG. 2 is a perspective view from the front left of a surface configuration of a vehicle body according to our novel design, the perspective view from the front right being mirror symmetrical;

[30] **Foreign Application Priority Data**

Jul. 21, 1998 [DE] Germany 498 07 266

FIG. 3 is a right side view of a surface configuration of a vehicle body according to our novel design, the left side view being mirror symmetrical;

[51] **LOC (7) Cl.** **12-08**

FIG. 4 is a perspective view from the rear right of a surface configuration of a vehicle body according to our novel design, the perspective view from the rear left being mirror symmetrical;

[52] **U.S. Cl.** **D12/92**

FIG. 5 is a rear view of a surface configuration of a vehicle body according to our novel design; and,

[58] **Field of Search** D12/90-92; 296/185

FIG. 6 is a top view of a surface configuration of a vehicle body according to our novel design.

[56] **References Cited**

The broken line included depicts environment and is not part of the claimed design.

U.S. PATENT DOCUMENTS

D. 380,178	6/1997	Sacco et al.	D12/92
D. 393,610	4/1998	Sacco et al.	D12/92
D. 395,847	7/1998	Sacco et al.	D12/92
D. 407,997	4/1999	Sacco et al.	D12/92

1 Claim, 4 Drawing Sheets

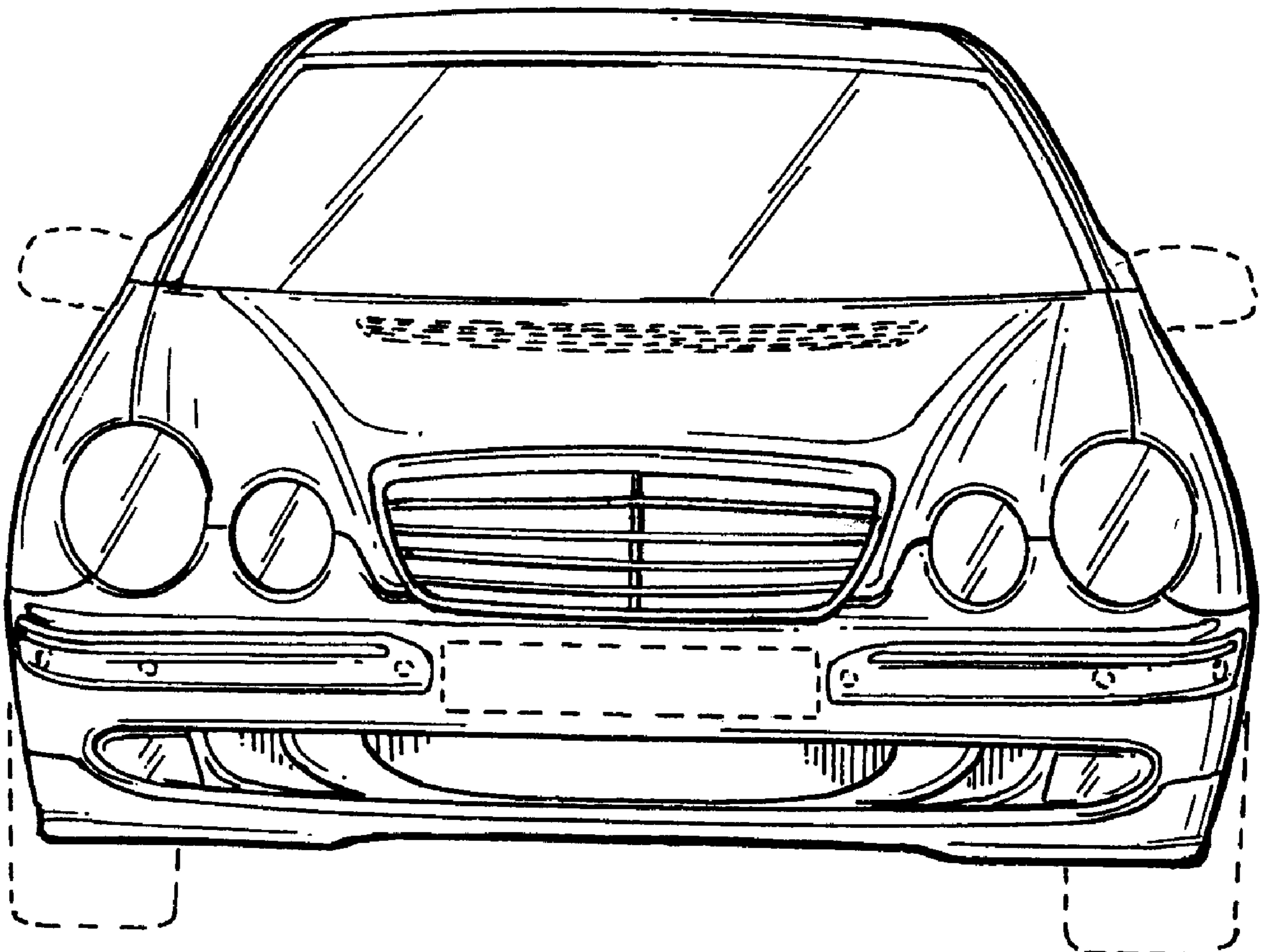

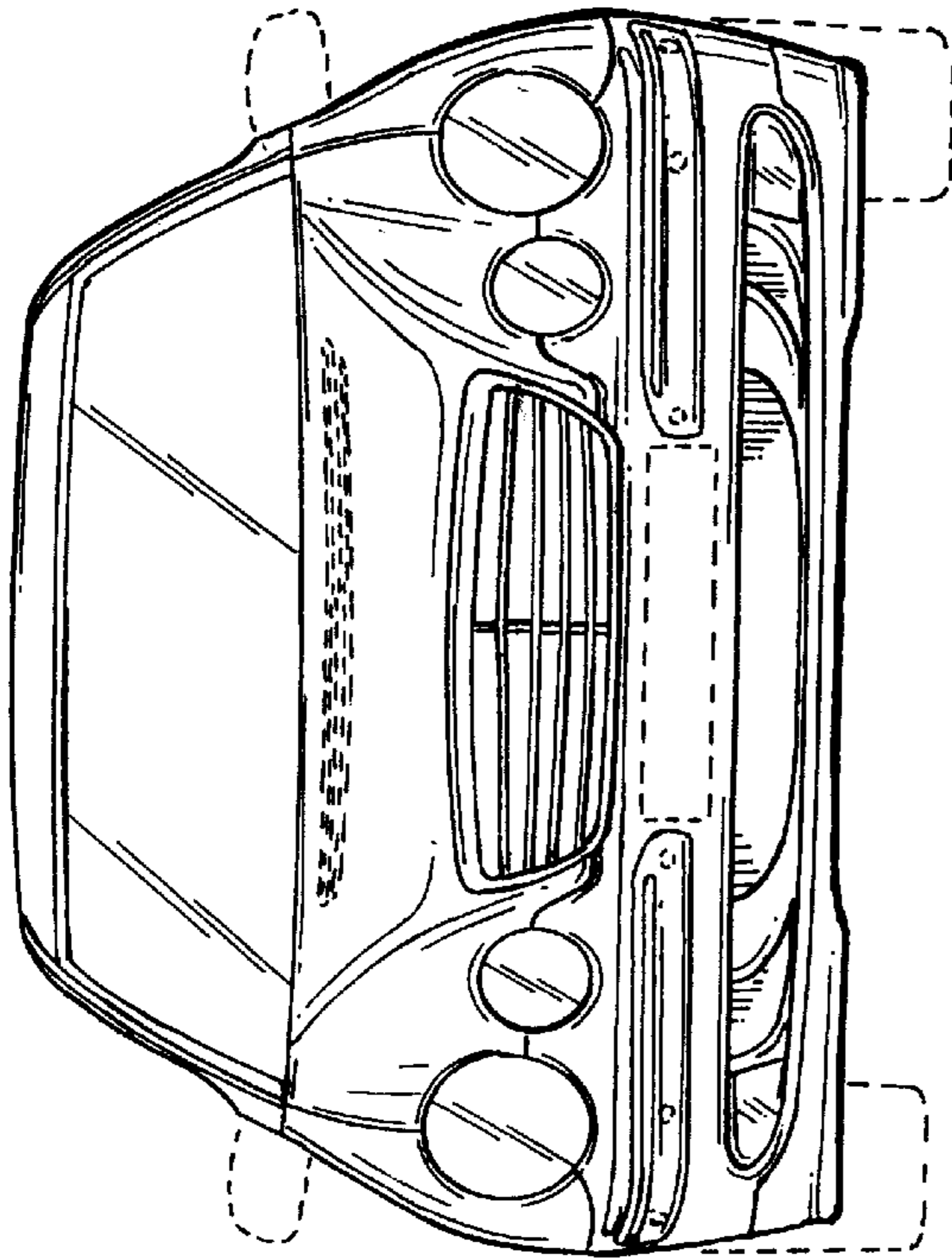

FIG.1

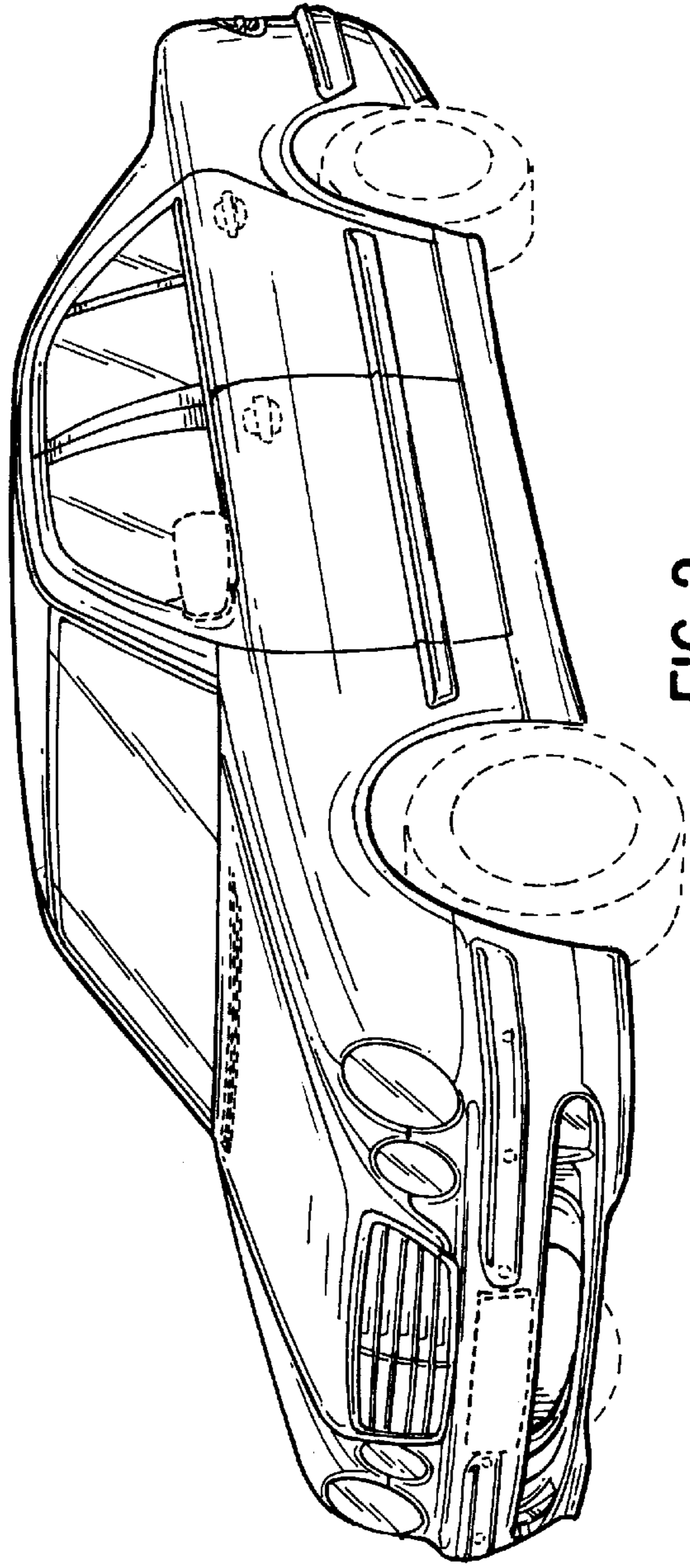

FIG.2

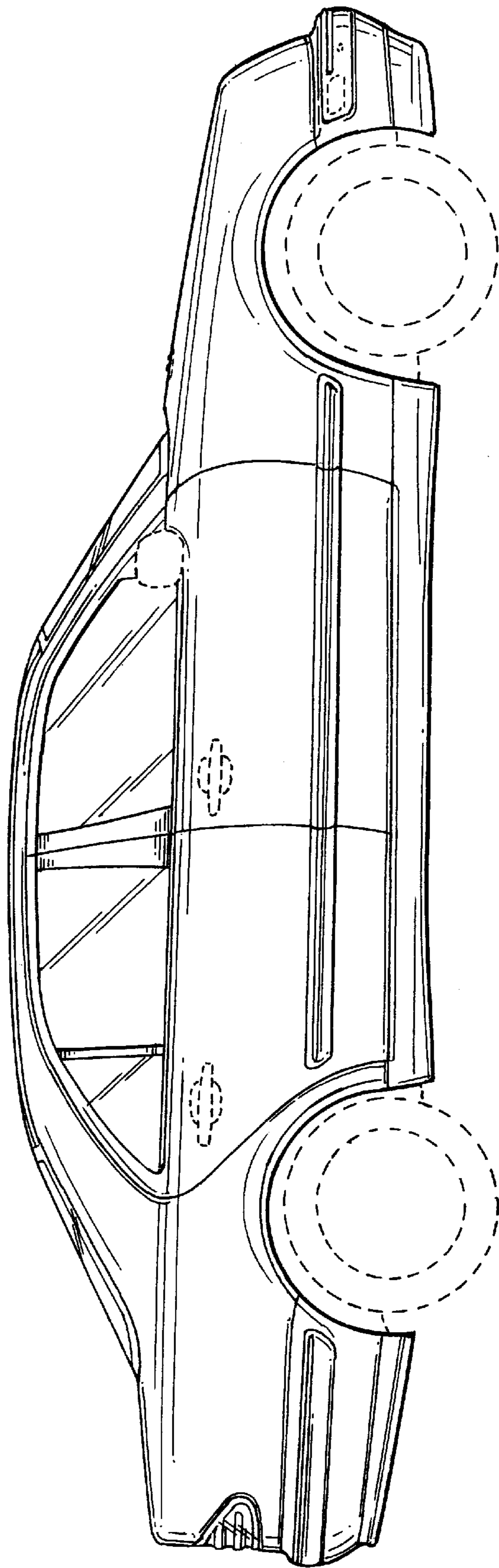

FIG. 3

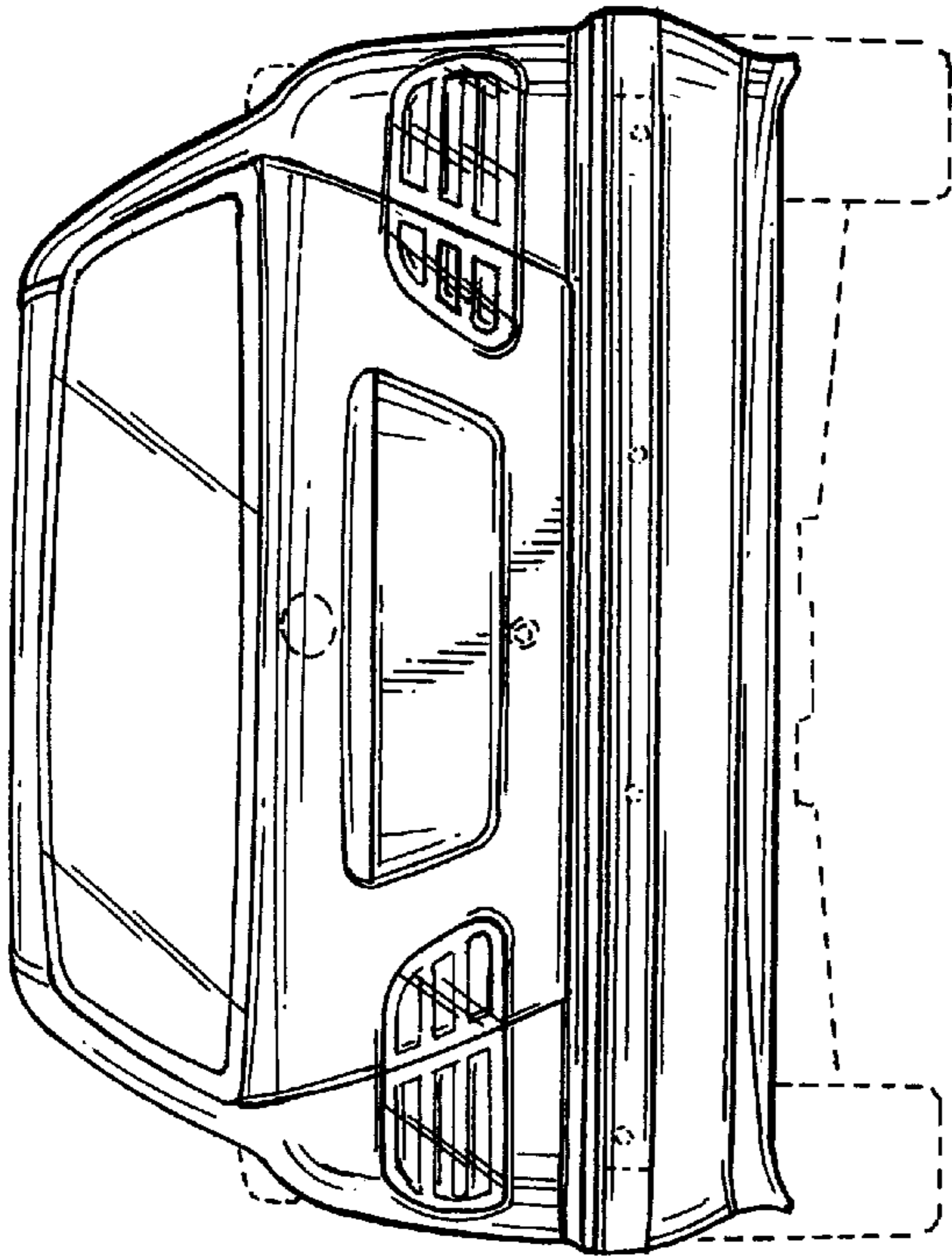

FIG. 5

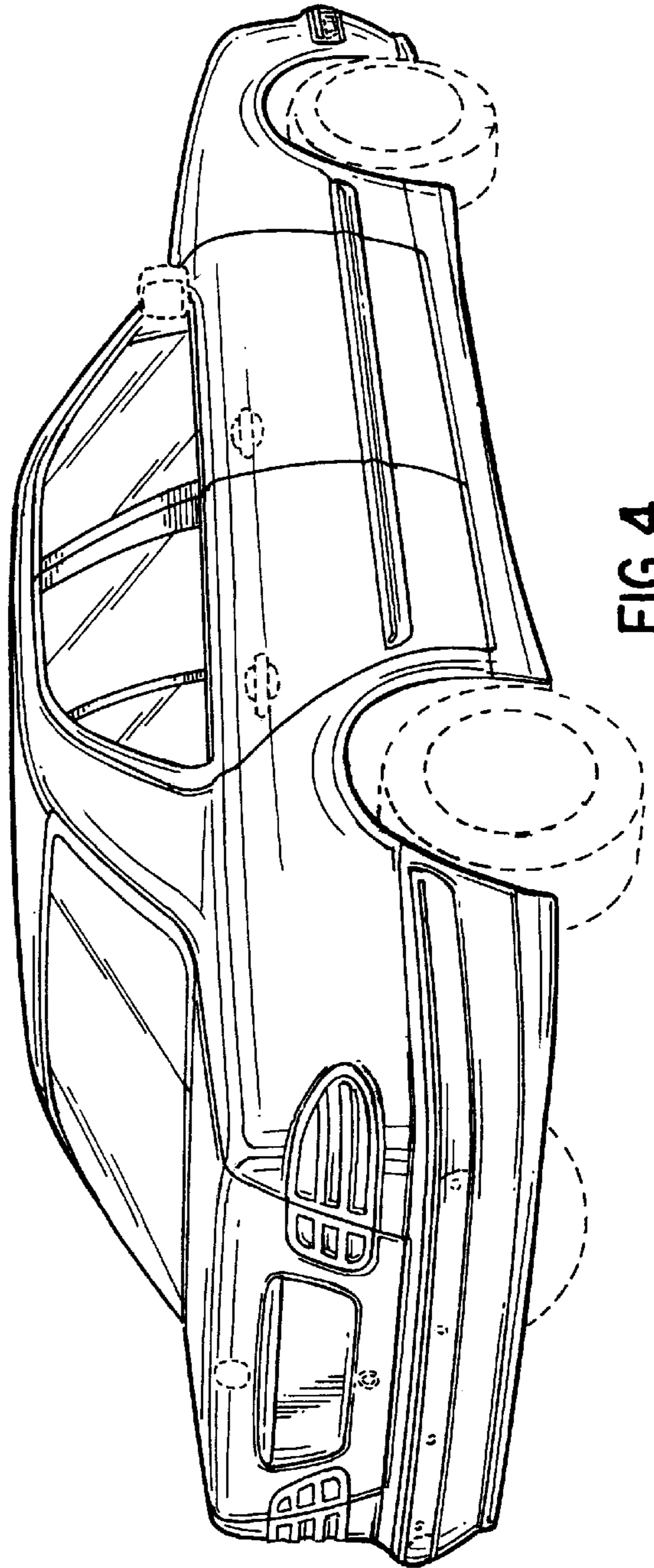

FIG. 4

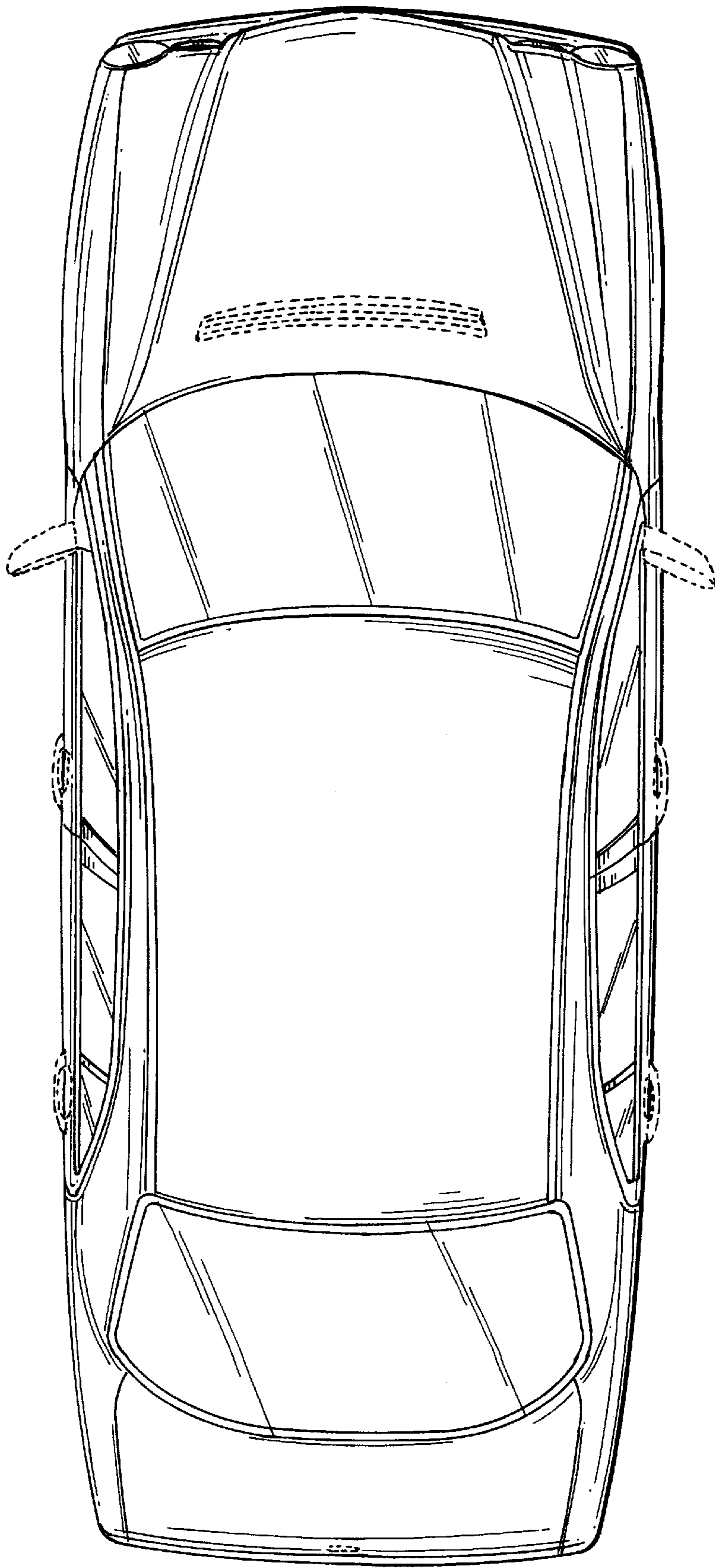

FIG. 6