



US00D419451S

United States Patent [19]

[11] Patent Number: **Des. 419,451**

Briere et al.

[45] Date of Patent: **** Jan. 25, 2000**

[54] **SAFETY CLOSURE HAVING OVERSIZED THUMBPADS**

[75] Inventors: **Marc A. Briere**, Newburgh;
Christopher B. Clodfelter; **William D. Sprick**, both of Evansville, all of Ind.

[73] Assignee: **Rexam Plastics Inc.**, Evansville, Ind.

[**] Term: **14 Years**

[21] Appl. No.: **29/093,137**

[22] Filed: **Sep. 4, 1998**

Related U.S. Application Data

[63] Continuation-in-part of application No. 08/861,793, May 22, 1997, Pat. No. 5,836,466.

[51] **LOC (7) Cl.** **09-07**

[52] **U.S. Cl.** **D9/453**

[58] **Field of Search** D9/435, 438, 443, D9/445, 453, 454, 503, 504, 529; 215/214, 216, 217, 250, 252-254, 256, 257; 220/265, 266, 270, 276, 279, 280

References Cited

U.S. PATENT DOCUMENTS

- D. 162,893 4/1951 Soffer D9/443
- D. 162,894 4/1951 Soffer D9/443
- D. 241,317 9/1976 Brackman D9/529 X
- D. 370,845 6/1996 Sherman et al. D9/438
- D. 405,371 2/1999 Herr D9/453 X
- 3,399,796 9/1968 Steiner .
- 3,445,022 5/1969 Cilluffo .
- 3,794,200 2/1974 Marks .
- 3,848,761 11/1974 Libit .
- 3,904,062 9/1975 Grussen 215/252
- 3,934,744 1/1976 Curry .
- 3,949,893 4/1976 Uhlig .
- 3,984,021 10/1976 Uhlig .
- 3,993,208 11/1976 Ostrowsky .
- 3,993,209 11/1976 Julian .
- 4,037,747 7/1977 Acton et al. .
- 4,213,534 7/1980 Montgomery .
- 4,345,690 8/1982 Hopley .
- 4,351,443 9/1982 Uhlig .

- 4,376,497 3/1983 Mumford 215/216 X
- 4,413,743 11/1983 Summers .
- 4,452,363 6/1984 Davis 215/216
- 4,456,136 6/1984 Palsson .
- 4,653,672 3/1987 Tuerk et al. 215/216 X
- 4,667,836 5/1987 McLaren 215/216
- 4,756,435 7/1988 Schick et al. .
- 4,986,430 1/1991 Dutt 215/253
- 5,050,754 9/1991 Marino 215/256
- 5,292,020 3/1994 Narin .
- 5,456,375 10/1995 May 215/252
- 5,460,281 10/1995 Rapchak et al. .
- 5,462,182 10/1995 Opresco .
- 5,560,505 10/1996 Schneider et al. .
- 5,673,809 10/1997 Ohmi et al. 215/252
- 5,727,703 3/1998 Fuchs 215/214
- 5,819,967 10/1998 Lo 215/216 X
- 5,865,330 2/1999 Buono 215/216

FOREIGN PATENT DOCUMENTS

- 977312 12/1964 United Kingdom 215/254
- WO 90/02692 3/1990 WIPO .

Primary Examiner—Cathron B. Matta
Attorney, Agent, or Firm—Middleton & Reutlinger; John F. Salazar; Charles G. Lamb

[57] CLAIM

The ornamental design for a safety closure having oversized thumbpads, as shown and described.

DESCRIPTION

FIG. 1 is a top perspective view of a safety closure having oversized thumbpads according to a preferred embodiment of the present invention;

FIG. 2 is a front view of the safety closure having oversized thumbpads according to FIG. 1;

FIG. 3 is a left-side view of the safety closure having oversized thumbpads according to FIG. 1;

FIG. 4 is a top view of the safety closure having oversized thumbpads according to FIG. 1;

FIG. 5 is a bottom view of the safety closure having oversized thumbpads according to FIG. 1; and,

FIG. 6 is a bottom perspective view of the safety closure having oversized thumbpads according to FIG. 1.

1 Claim, 3 Drawing Sheets

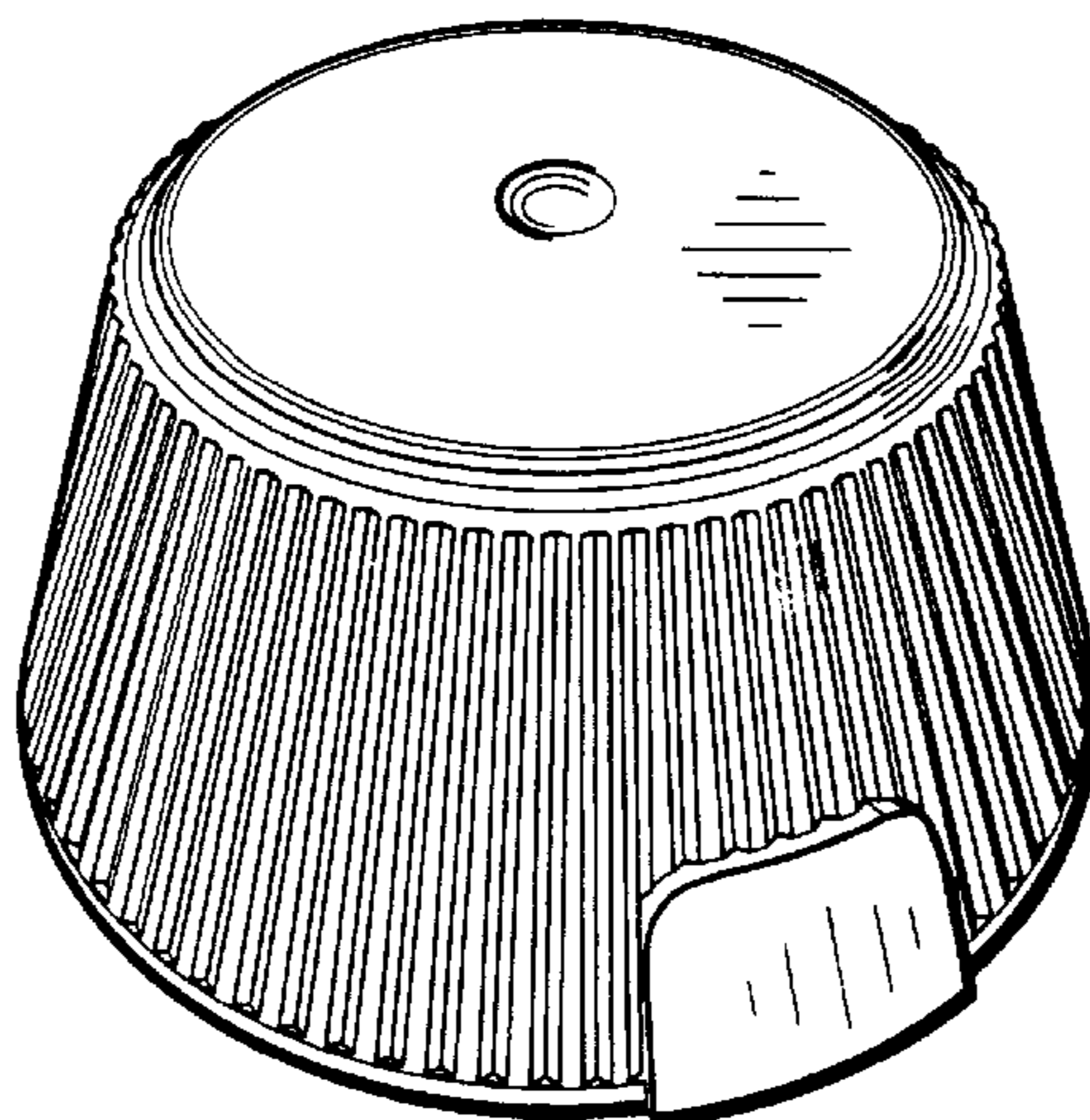

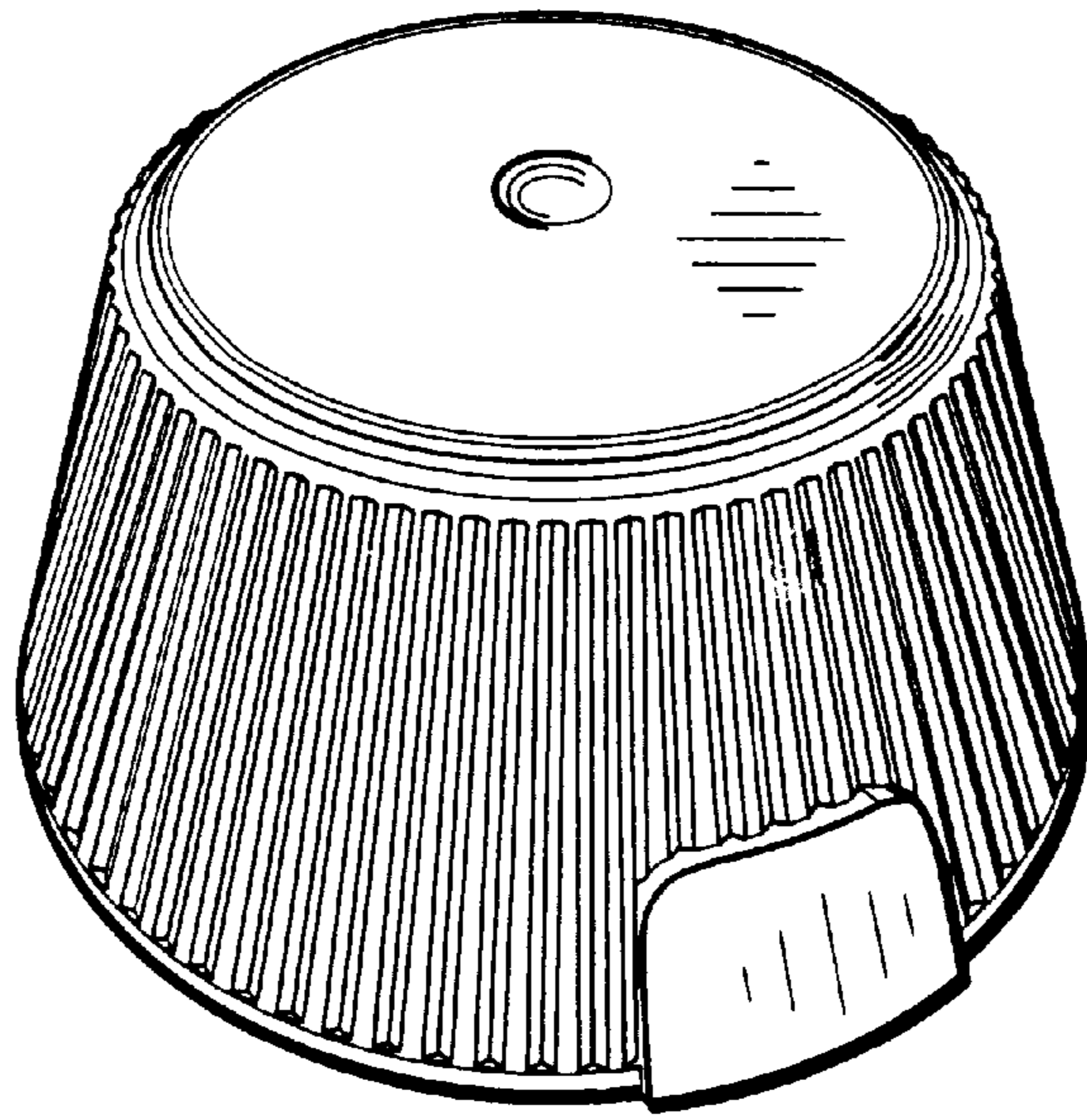

FIG. 1

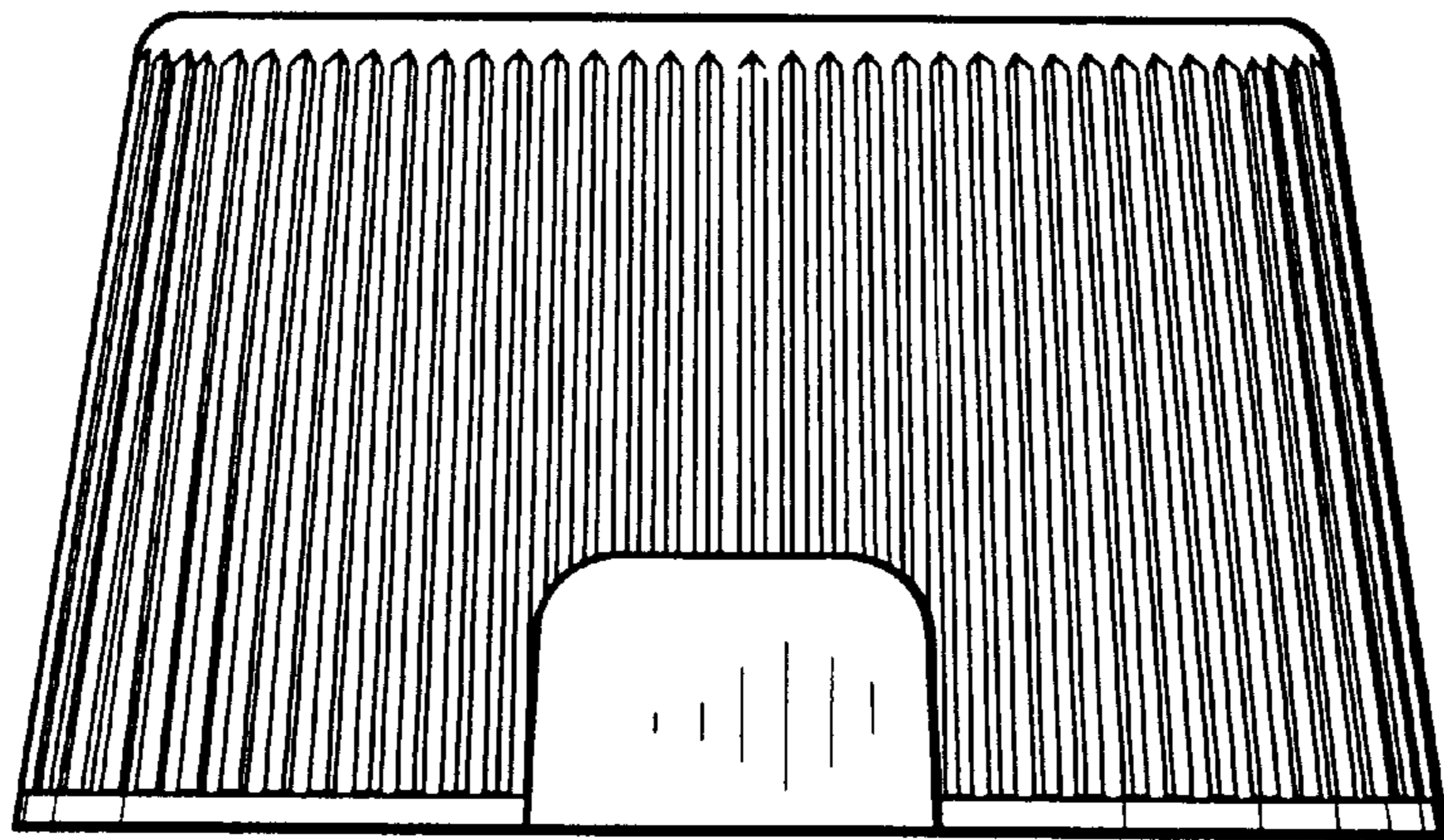

FIG. 2

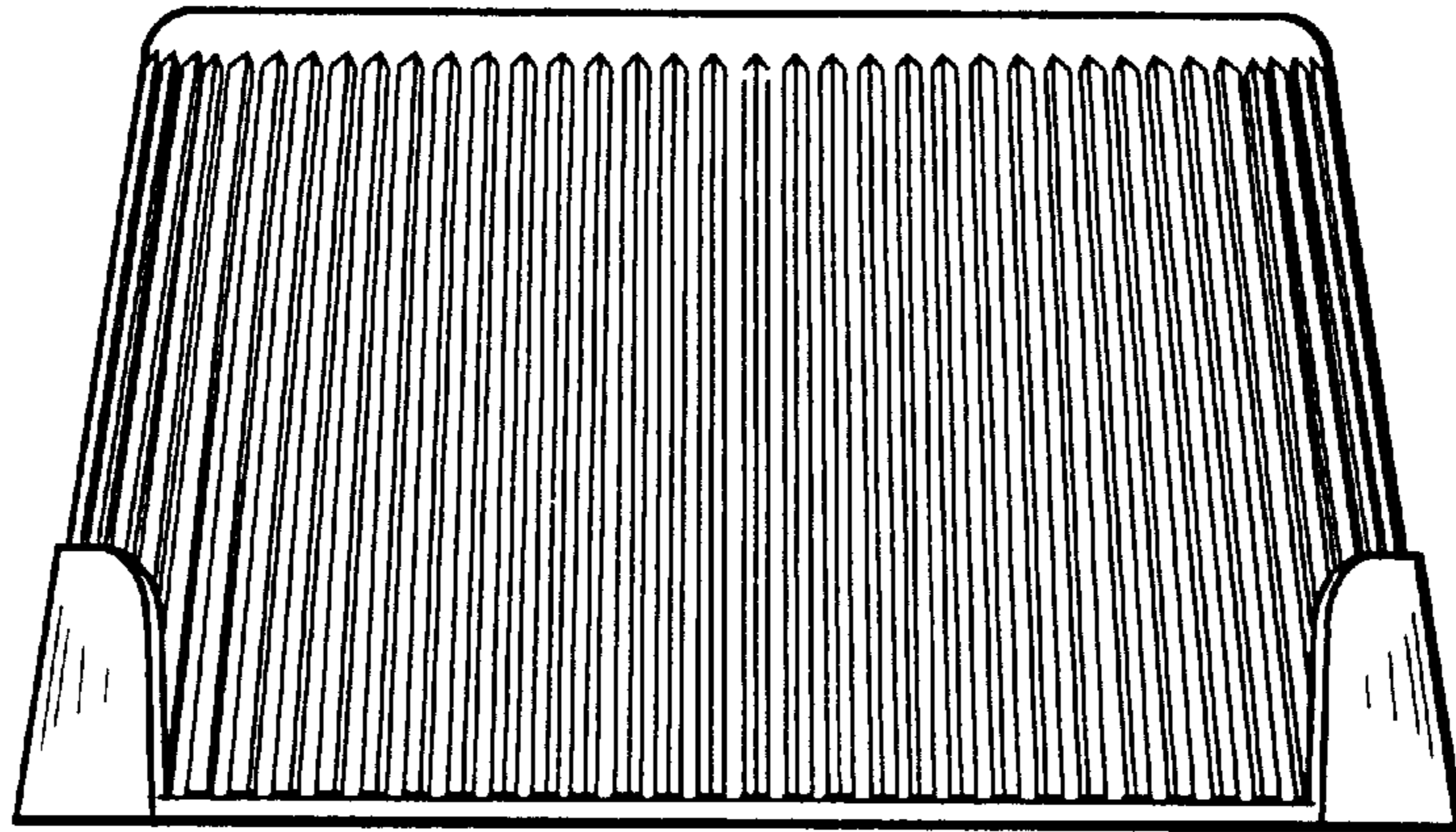

FIG. 3

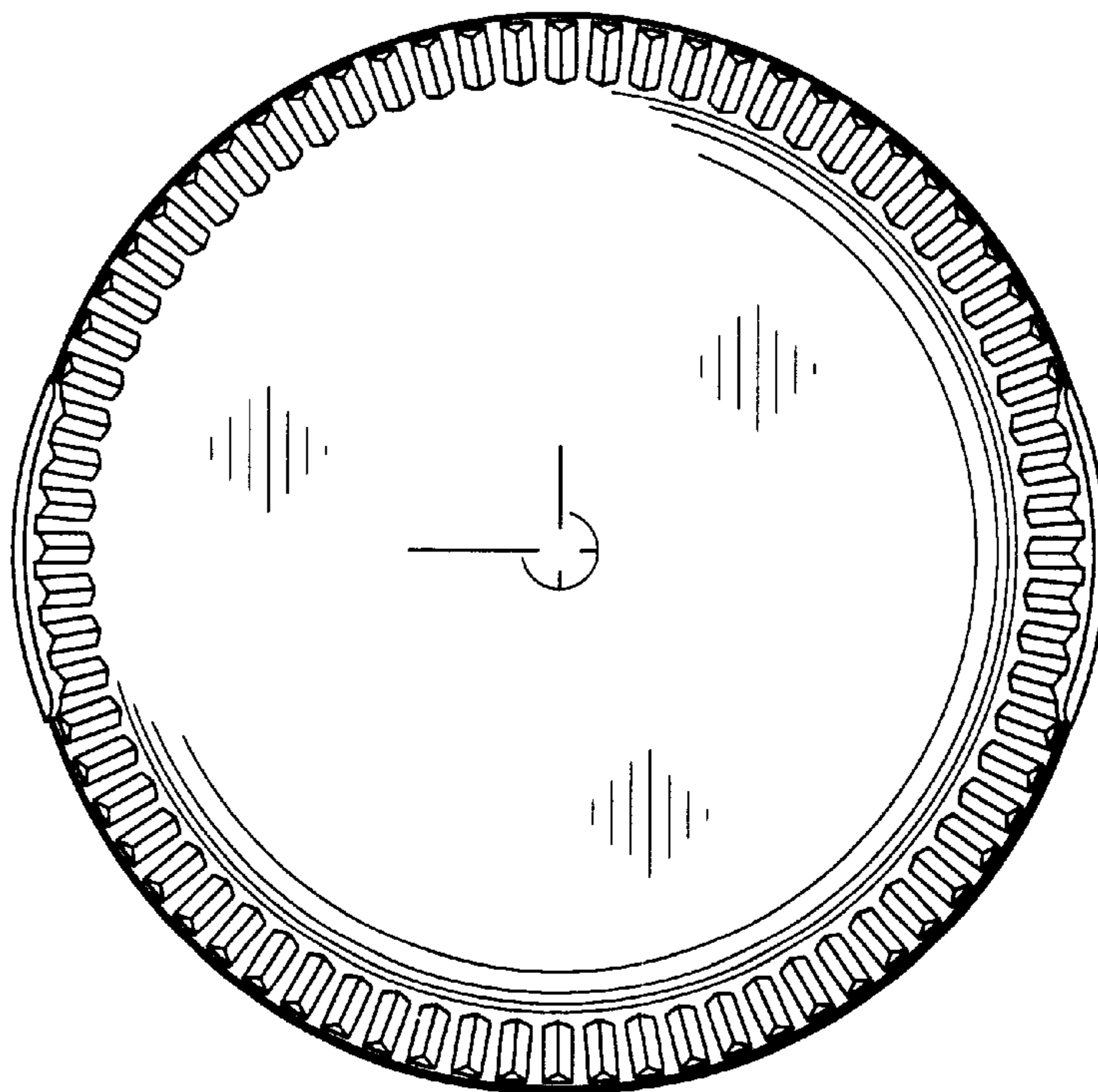

FIG. 4

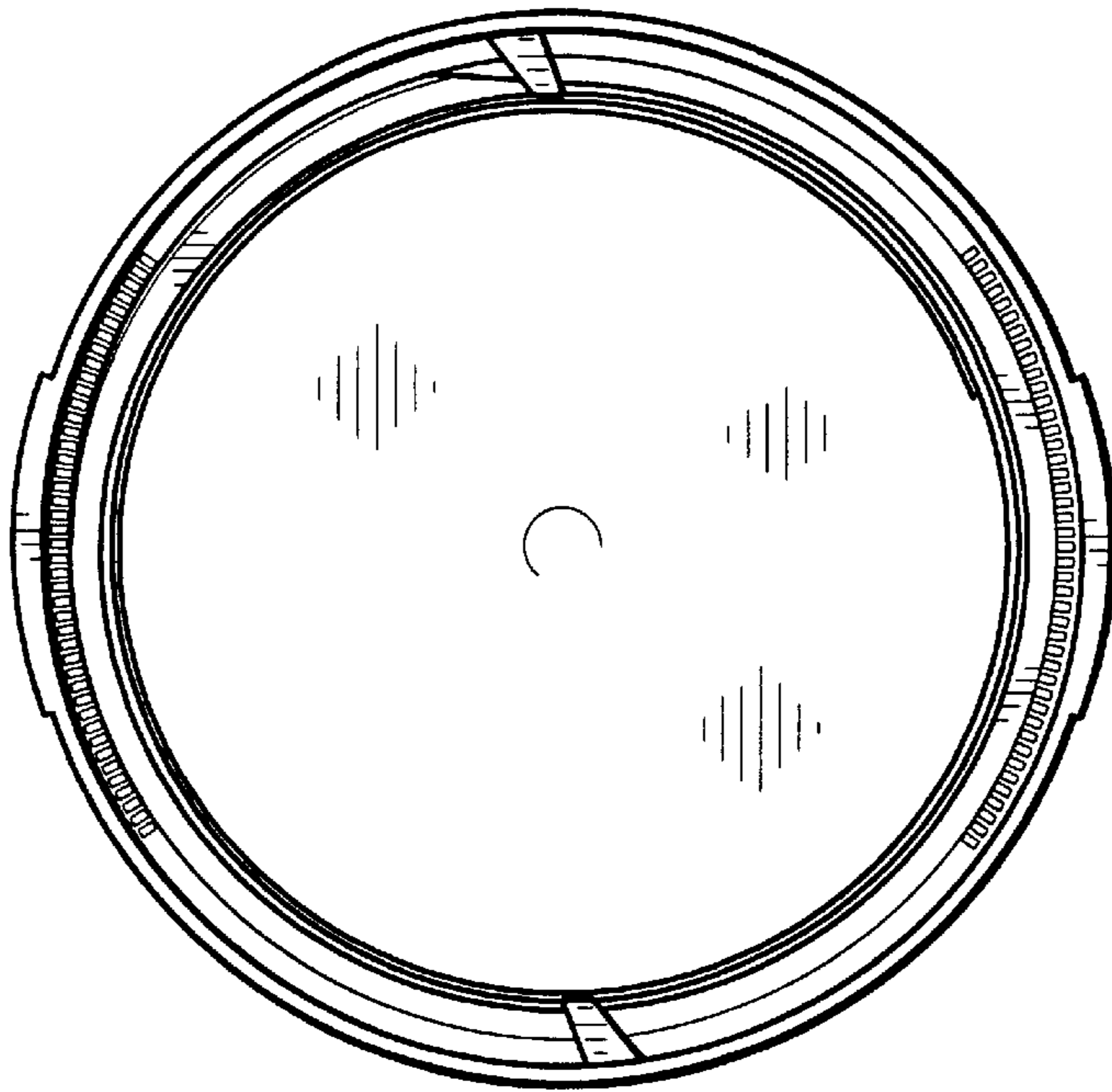

FIG. 5

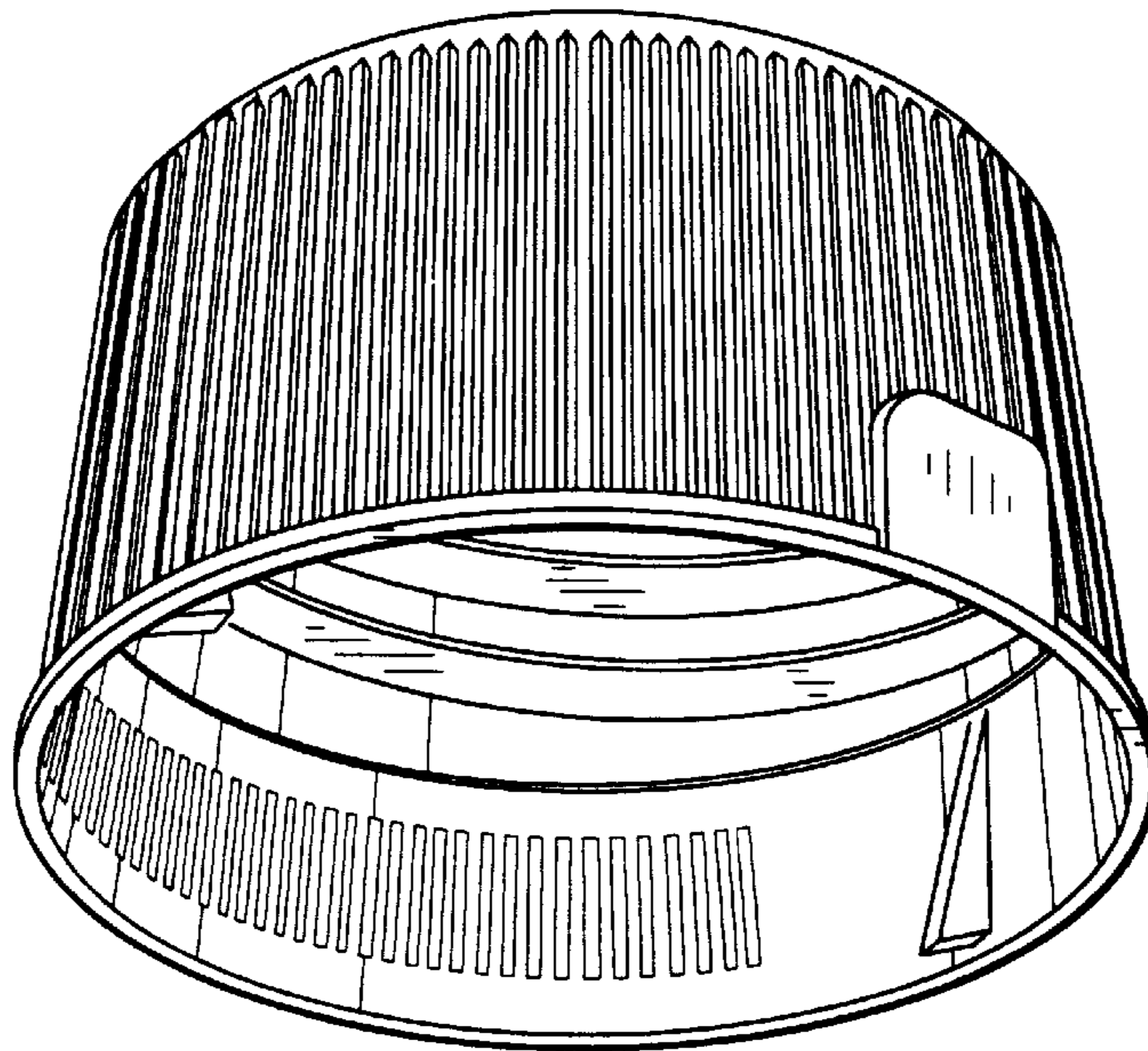

FIG. 6