



US00D419447S

# United States Patent [19] Molloy

[11] Patent Number: **Des. 419,447**

[45] Date of Patent: **\*\* Jan. 25, 2000**

[54] TAMPER EVIDENT, PULL-PUSH CLOSURE

[76] Inventor: **Glenn Robert Molloy**, 28 Southern Cross Drive, Cronin Islands, Queensland, Australia, 4217

[\*\*] Term: **14 Years**

[21] Appl. No.: **29/080,149**

[22] Filed: **Dec. 1, 1997**

[30] **Foreign Application Priority Data**

Jun. 12, 1997 [AU] Australia ..... 1857/97

[51] LOC (7) Cl. .... **09-07**

[52] U.S. Cl. .... **D9/449; D9/447**

[58] Field of Search ..... D9/435, 438, 447, D9/449, 453, 454; D7/398, 510, 511; 215/250, 251, 256; 220/266; 222/153.06, 525, 541.1, 541.5, 541.6, 541.9, 549

[56] **References Cited**

**U.S. PATENT DOCUMENTS**

- D. 226,555 3/1973 Weber ..... D9/447 X
- D. 358,295 5/1995 Moench ..... D9/447 X
- D. 396,807 8/1998 Lauth ..... D9/503

- 4,749,103 6/1988 Barriac ..... 222/153.06 X
- 5,145,094 9/1992 Perlmutter ..... 222/153.1
- 5,456,374 10/1995 Beck ..... 215/251
- 5,465,876 11/1995 Crisci ..... 222/153.1
- 5,588,562 12/1996 Sander et al. .... 222/153.06
- 5,680,965 10/1997 Beck ..... 222/153.06

*Primary Examiner*—Cathron B. Matta  
*Attorney, Agent, or Firm*—James Creighton Wray; Meera P. Narasimhan

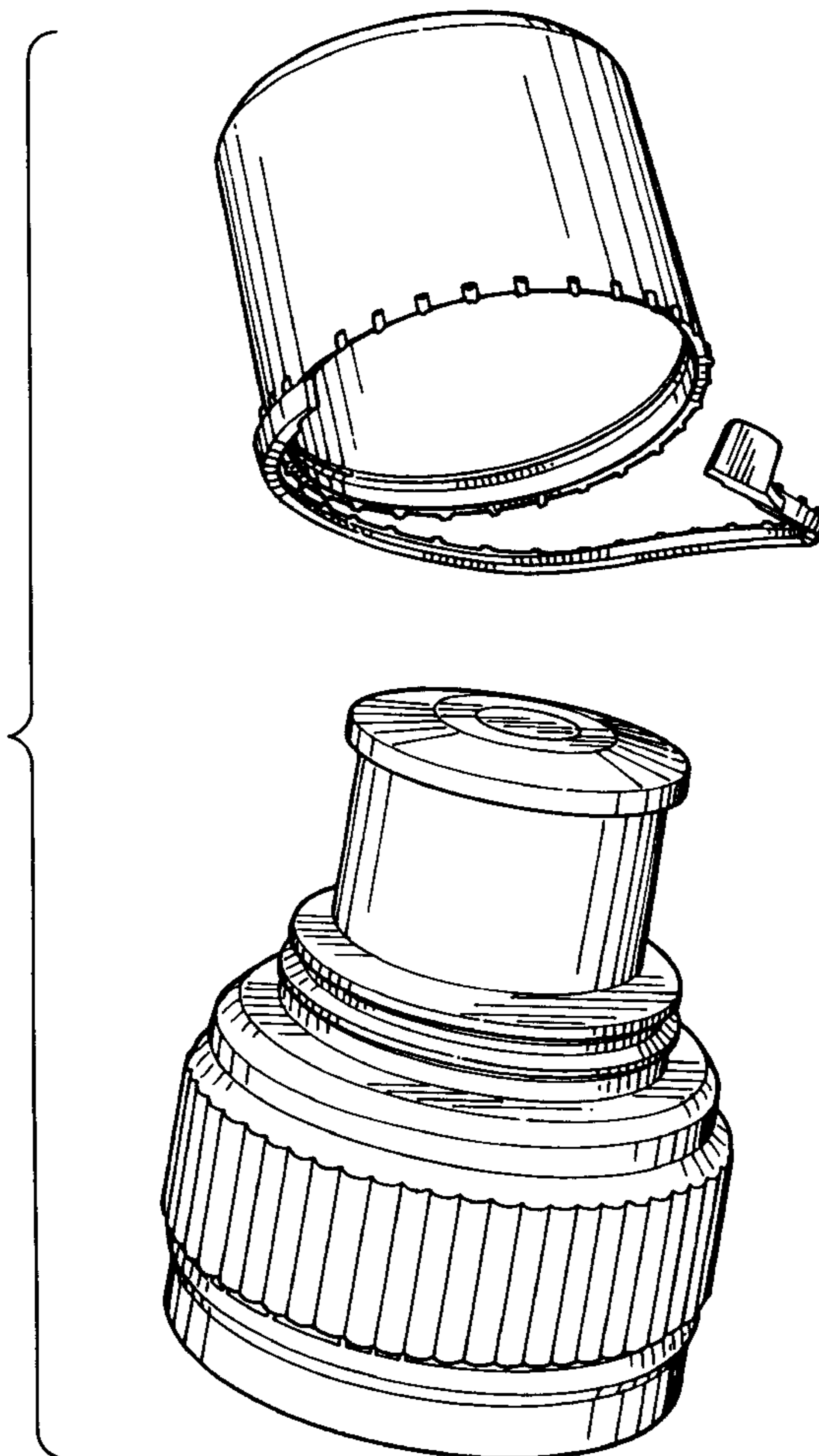
[57] **CLAIM**

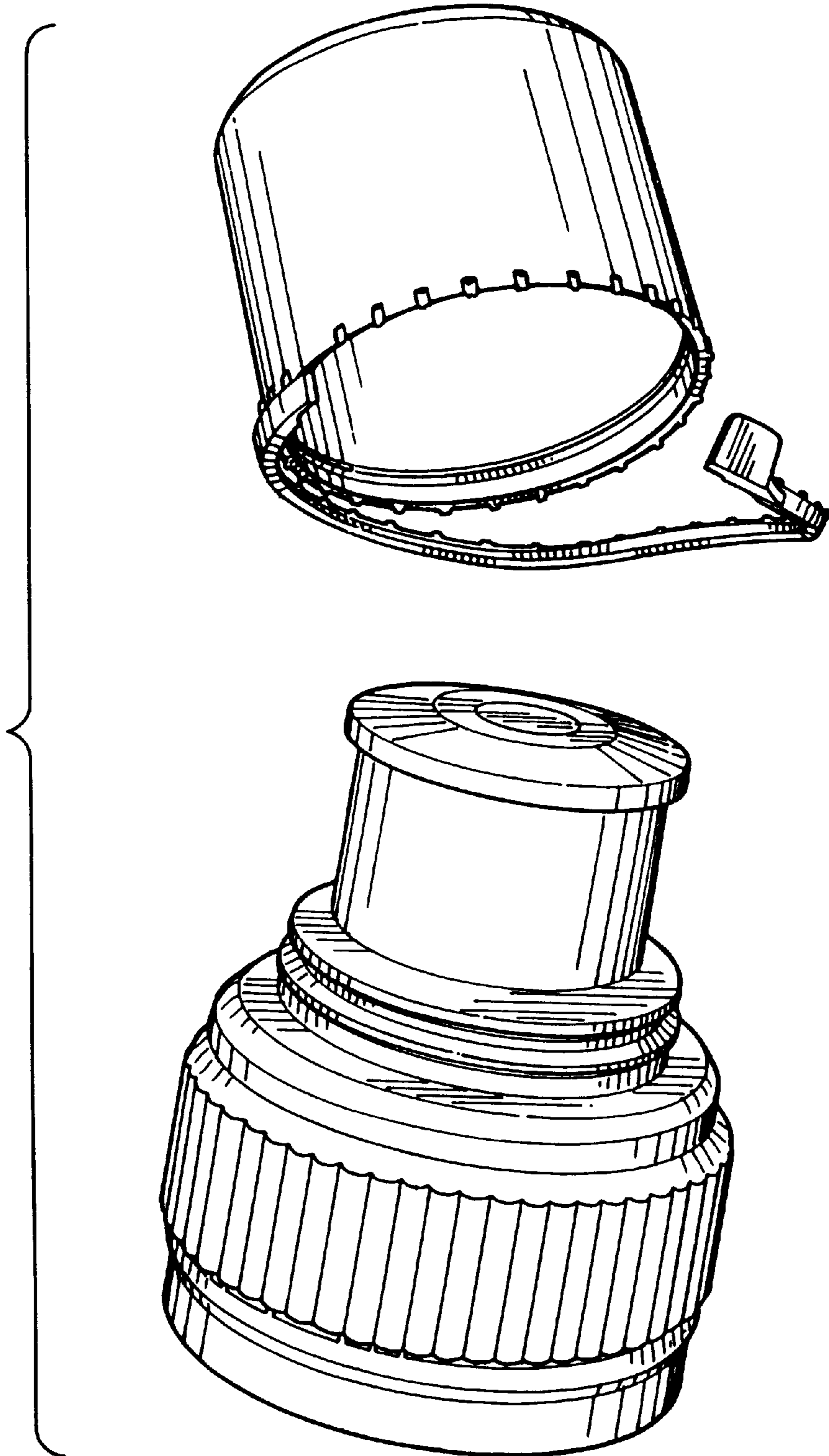
The design for a tamper evident, pull-push closure, as shown and described.

**DESCRIPTION**

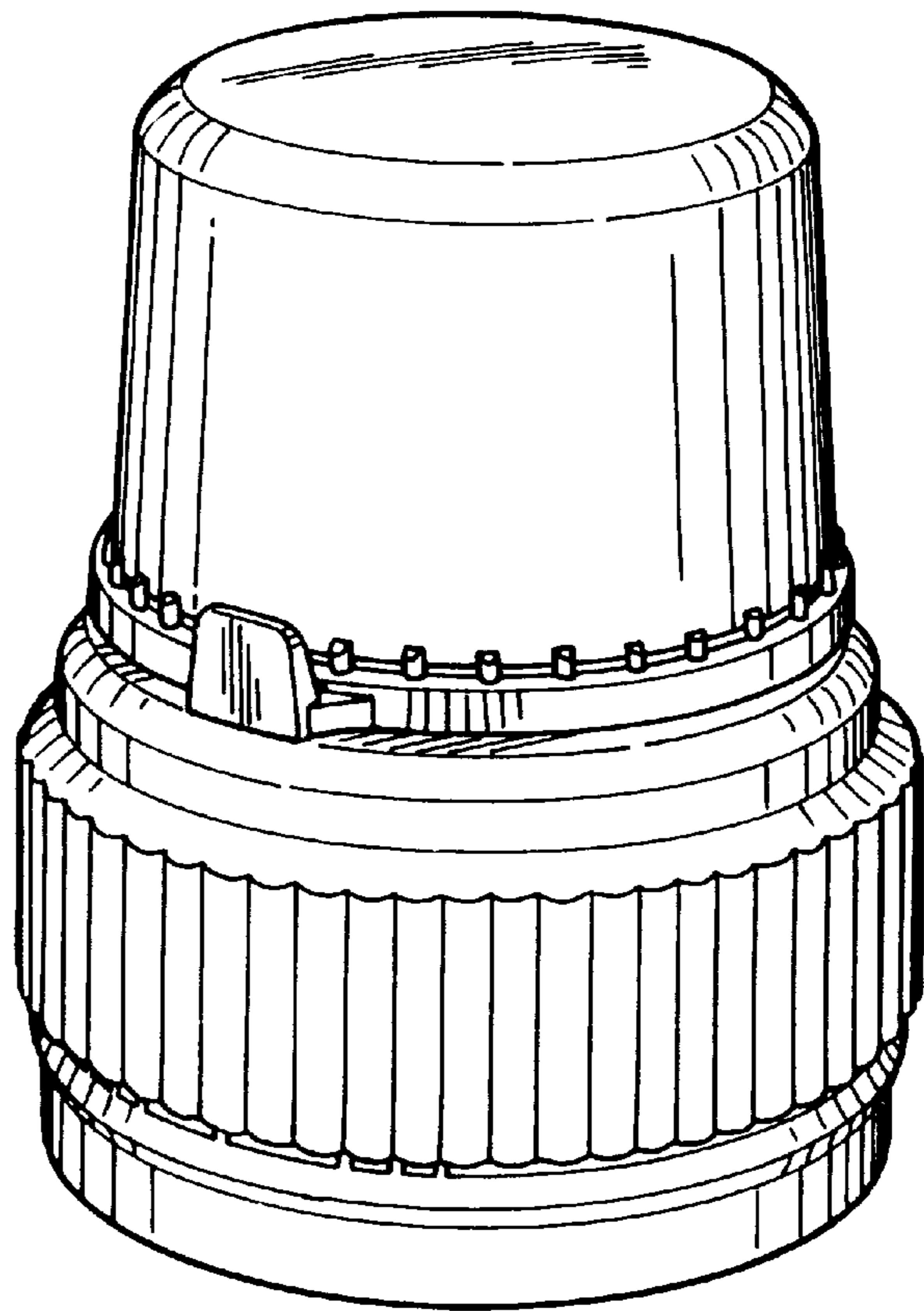
FIG. 1 is an exploded perspective view with the cap shown removed and the tamper evident strip partially pulled away. FIG. 2 is a perspective view with the cap shown attached. FIG. 3 is a top plan view of FIG. 2. FIG. 4 is a front elevation of FIG. 2. FIG. 5 is a rear elevation view of FIG. 2. FIG. 6 is a left side elevation view of FIG. 2; and, FIG. 7 is a right side elevation view of FIG. 2. The bottom and the interior of the closure is disclaimed.

**1 Claim, 3 Drawing Sheets**

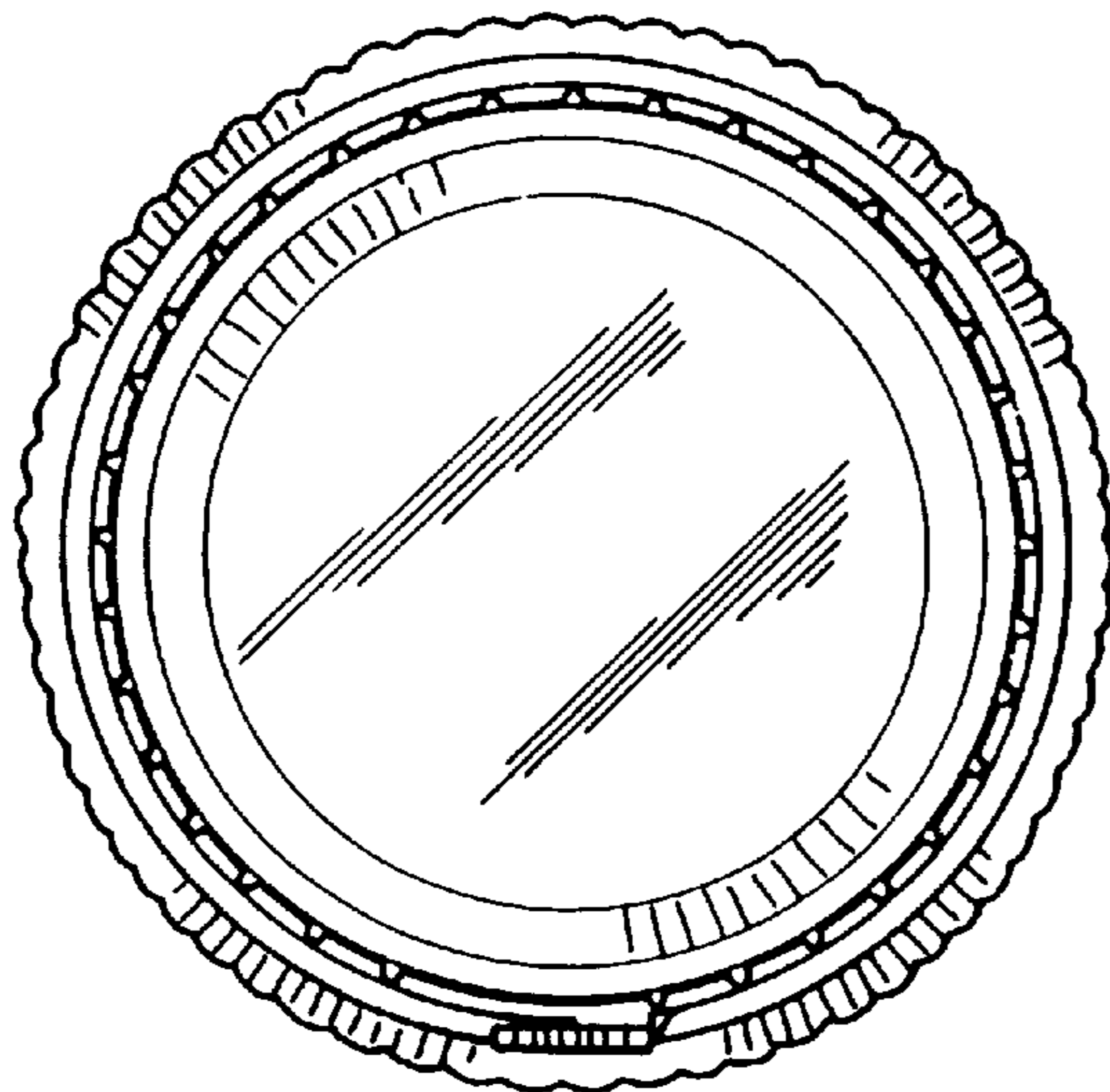




*FIG. 1*



*FIG. 2*



*FIG. 3*

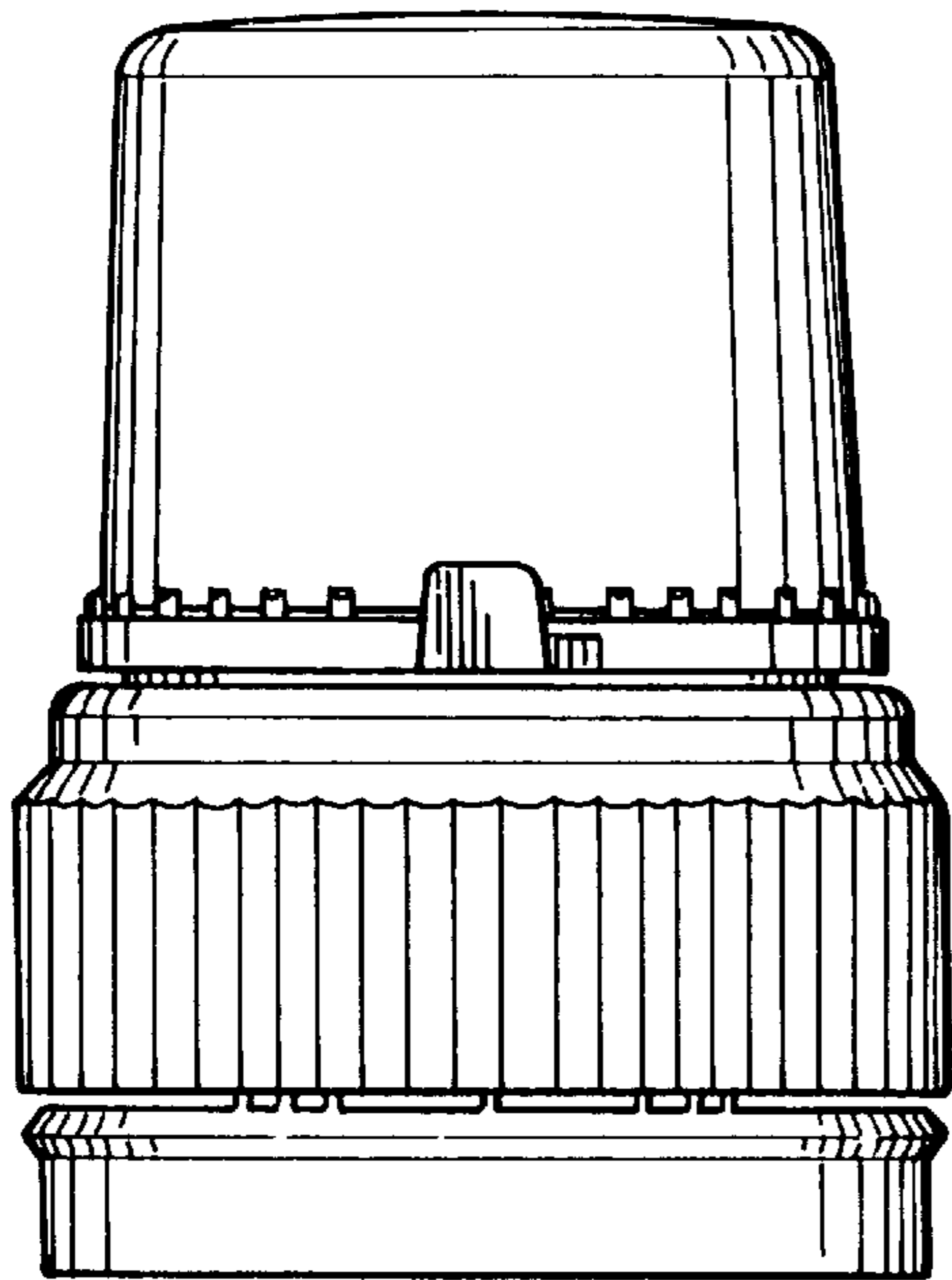


FIG. 4

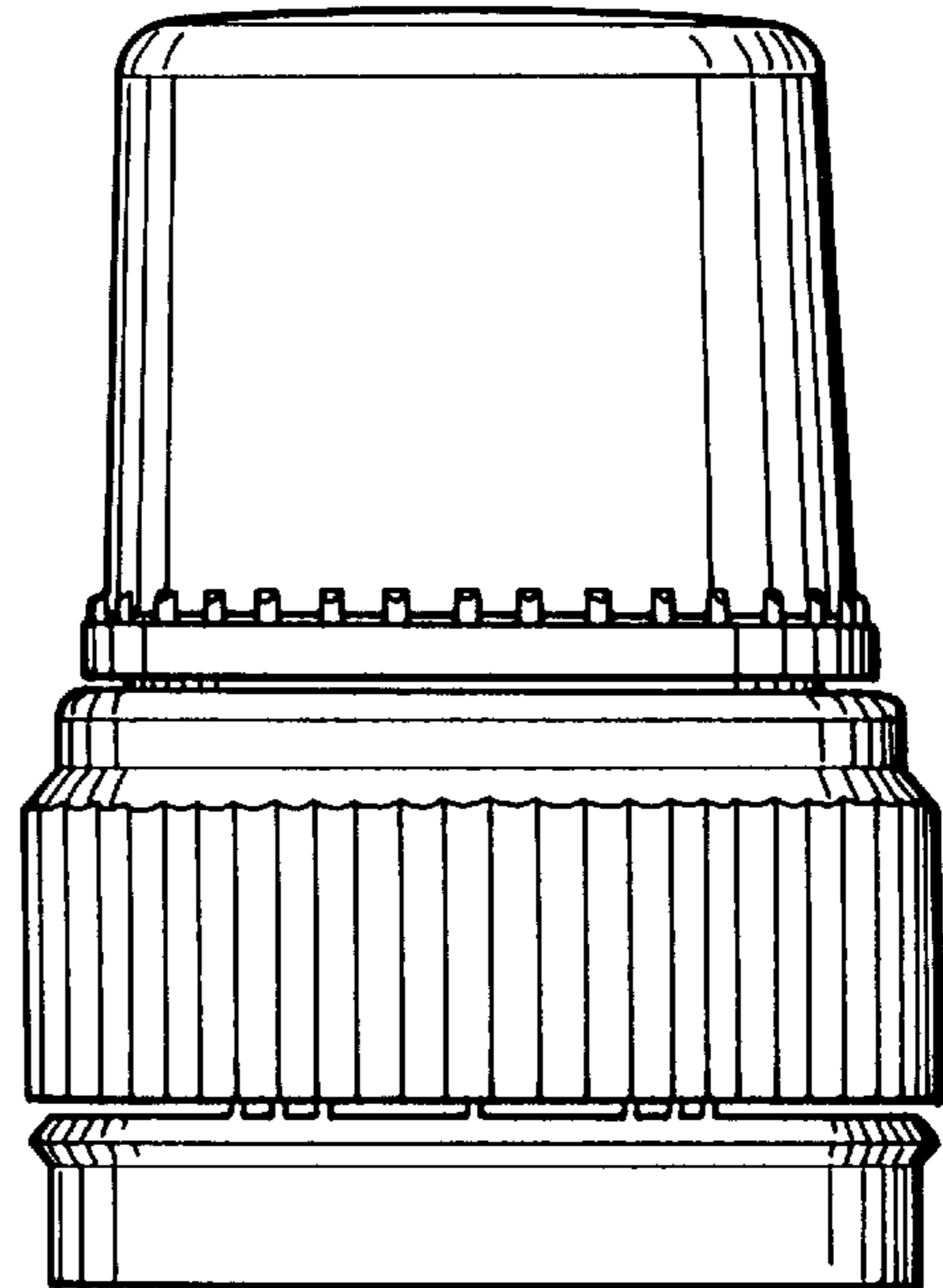


FIG. 5

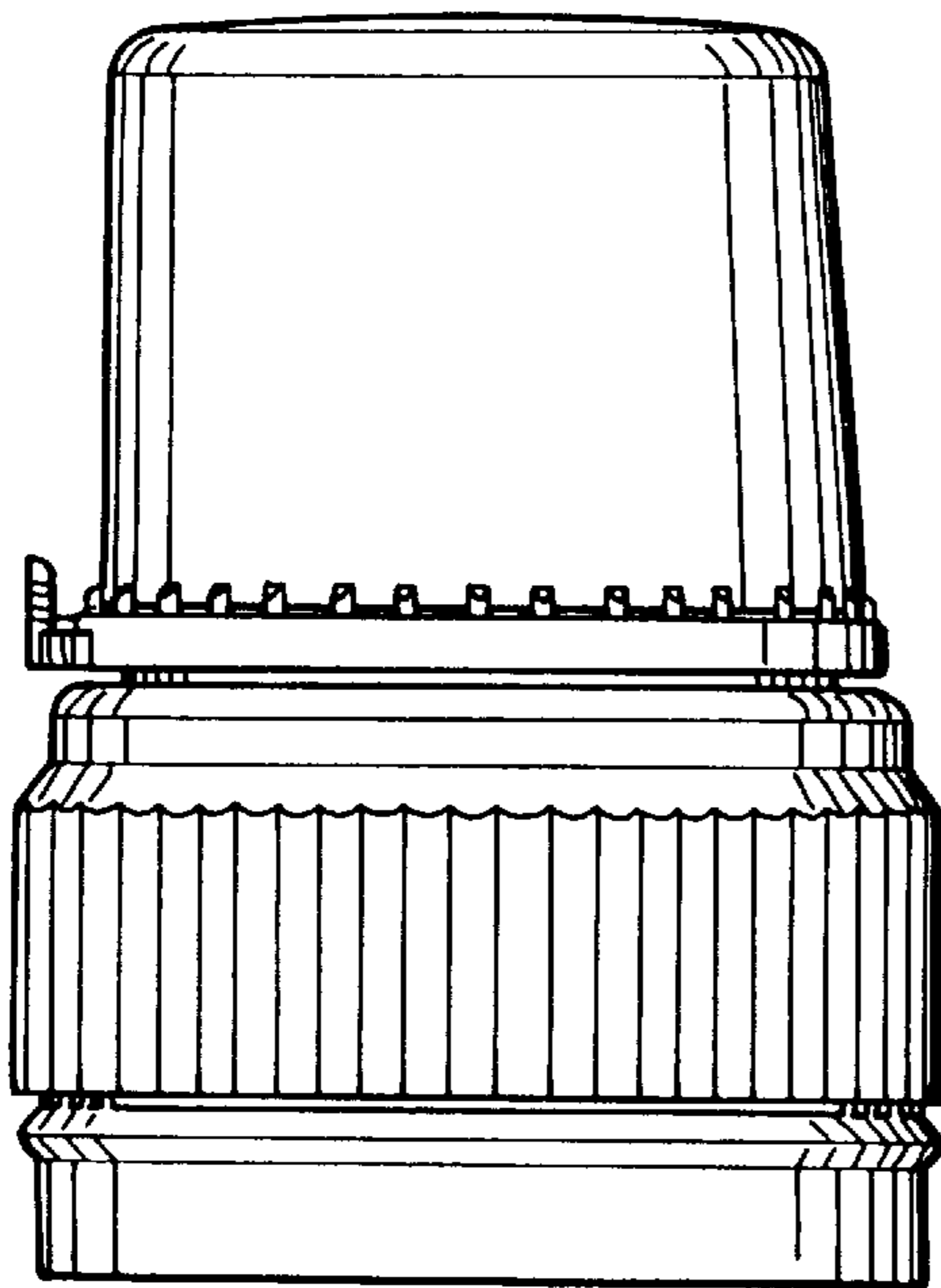


FIG. 6

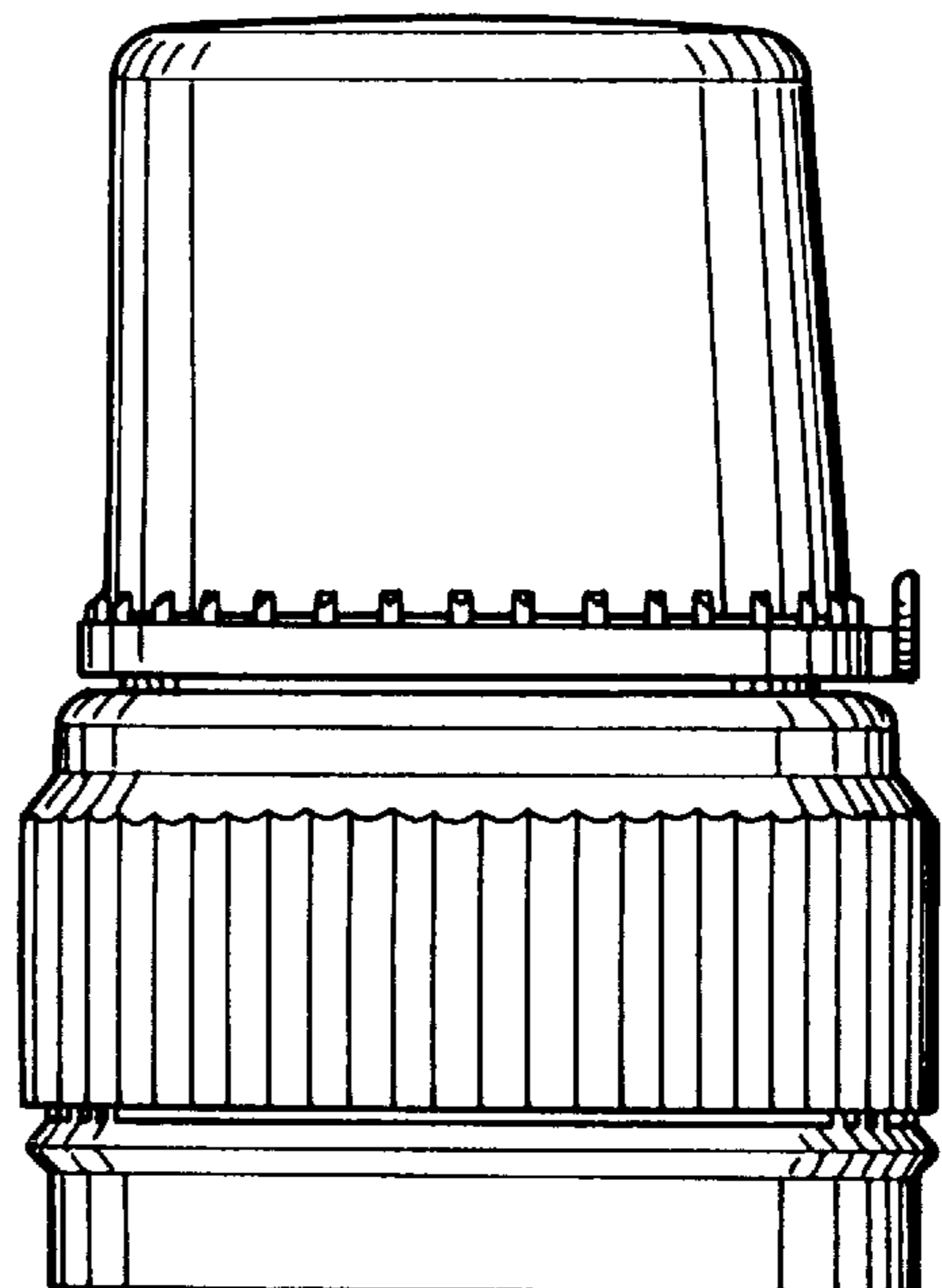


FIG. 7