



US00D419390S

# United States Patent [19]

Freese et al.

[11] **Patent Number: Des. 419,390**

[45] **Date of Patent: \*\* Jan. 25, 2000**

[54] **SIDE ELEMENTS FOR A LUNCH COOLER**

[75] Inventors: **T. Brent Freese**, Gurnee, Ill.; **Douglas Carpioux**, Milwaukee, Wis.; **Eric Fickas**, Germantown, Wis.; **Raymond Klein**, Milwaukee, Wis.; **Scott Micoley**, Cedarburg, Wis.

[73] Assignee: **Outer Circle Products, Ltd.**, Chicago, Ill.

[\*\*] Term: **14 Years**

[21] Appl. No.: **29/097,643**

[22] Filed: **Dec. 10, 1998**

### Related U.S. Application Data

[62] Division of application No. 29/084,625, Mar. 6, 1998, Pat. No. Des. 406,729.

[51] **LOC (7) Cl.** ..... **07-06**

[52] **U.S. Cl.** ..... **D7/607**

[58] **Field of Search** ..... D7/605, 607, 709;  
D3/273, 276, 283, 287, 289, 290, 301;  
62/457.1, 457.7, 371; 220/410-412, DIG. 10;  
206/223, 541, 545, 546, 549; 383/109,  
110, 113

### [56] References Cited

#### U.S. PATENT DOCUMENTS

D. 340,621 10/1993 Melk ..... D7/607

D. 340,840 11/1993 Melk ..... D7/607  
D. 371,052 6/1996 Melk ..... D7/607  
D. 371,724 7/1996 Melk ..... D7/607  
4,767,039 8/1988 Jacober ..... 224/153

*Primary Examiner*—Terry A. Wallace  
*Attorney, Agent, or Firm*—Trexler, Bushnell, Giangiorgi & Blackstone, Ltd.

### [57] CLAIM

The ornamental design for a side elements for a lunch cooler, as shown and described.

### DESCRIPTION

FIG. 1 is a top, left side, perspective view of the side elements for a lunch cooler of the present design, the central body portion of the cooler being shown in broken line and forming no part of this embodiment of the design;

FIG. 2 is a front elevational view thereof;

FIG. 3 is a rear side elevational view thereof.

FIG. 4 is a left side elevational view thereof, the right side being a mirror image thereof;

FIG. 5 is a top plan view thereof; and,

FIG. 6 is a bottom plan view thereof.

**1 Claim, 6 Drawing Sheets**

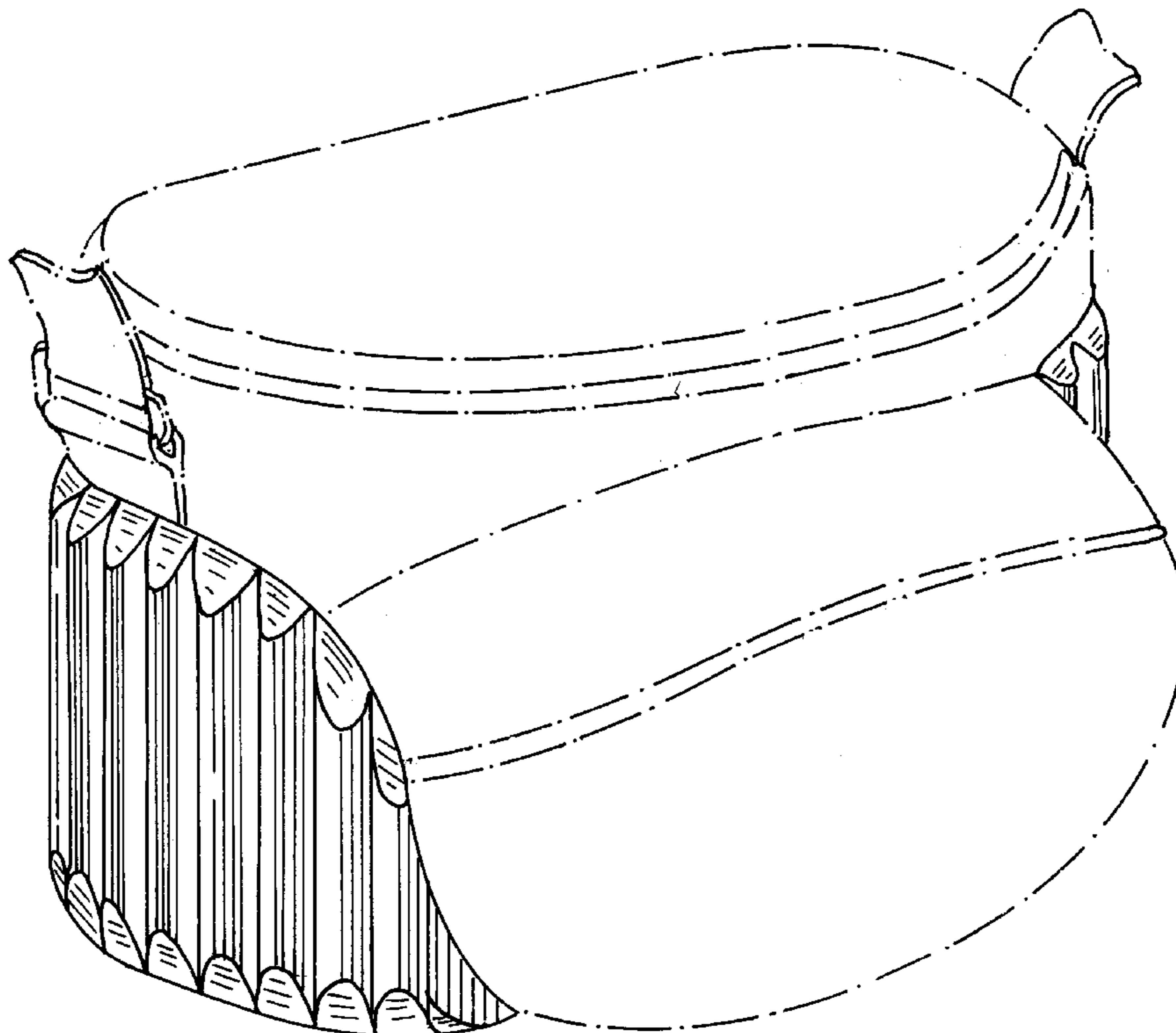
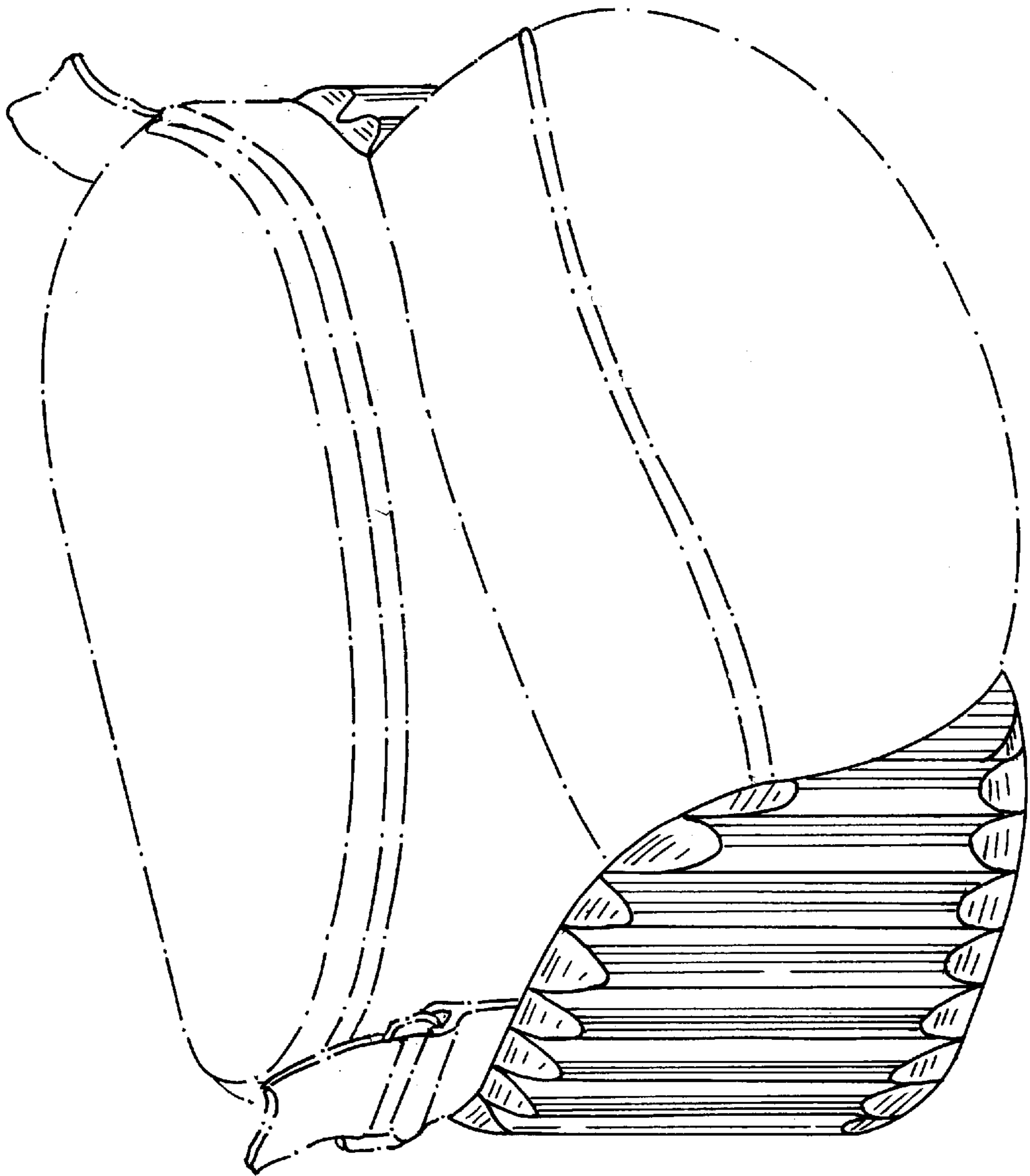

FIG. 1



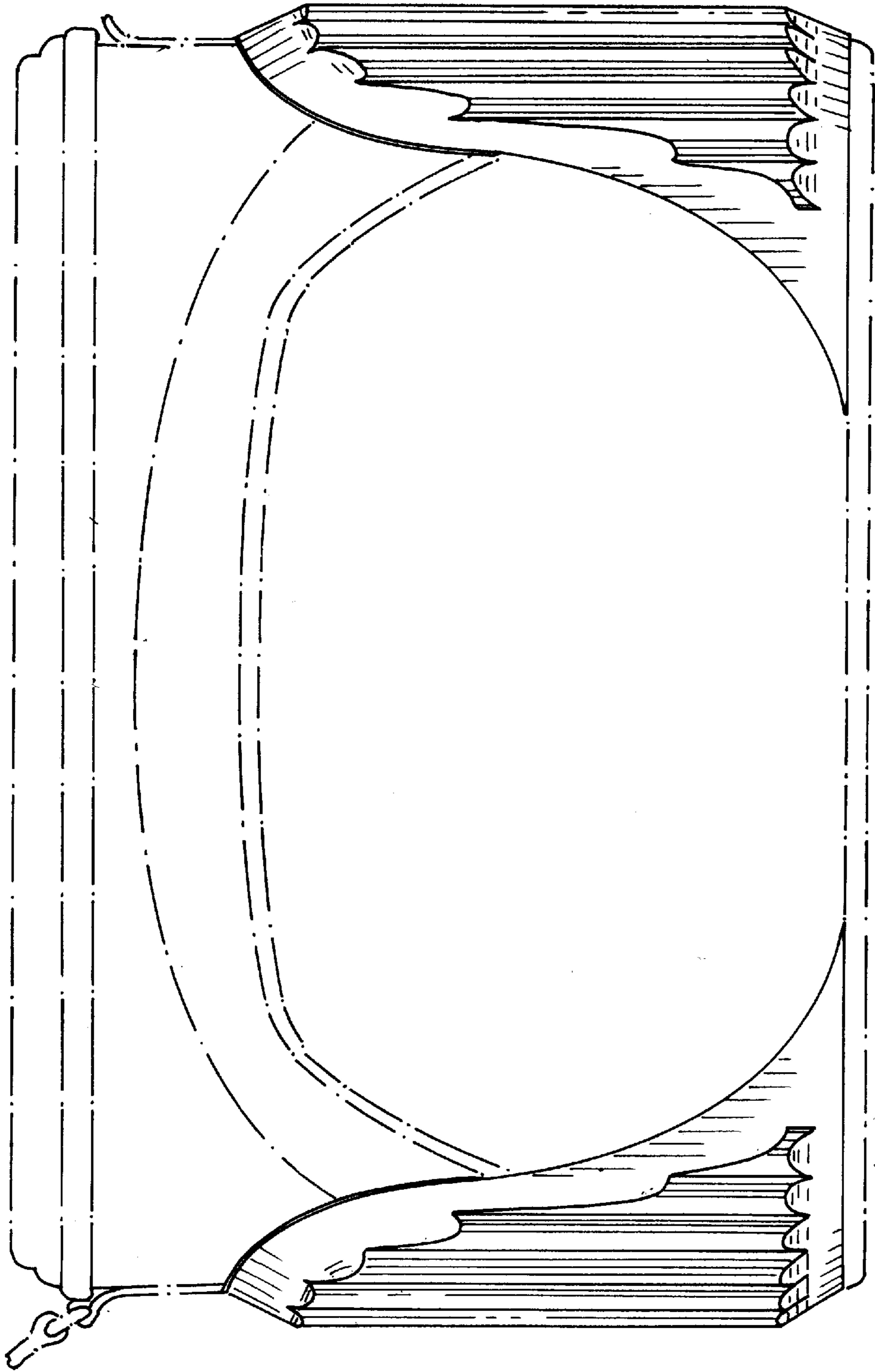

FIG. 2

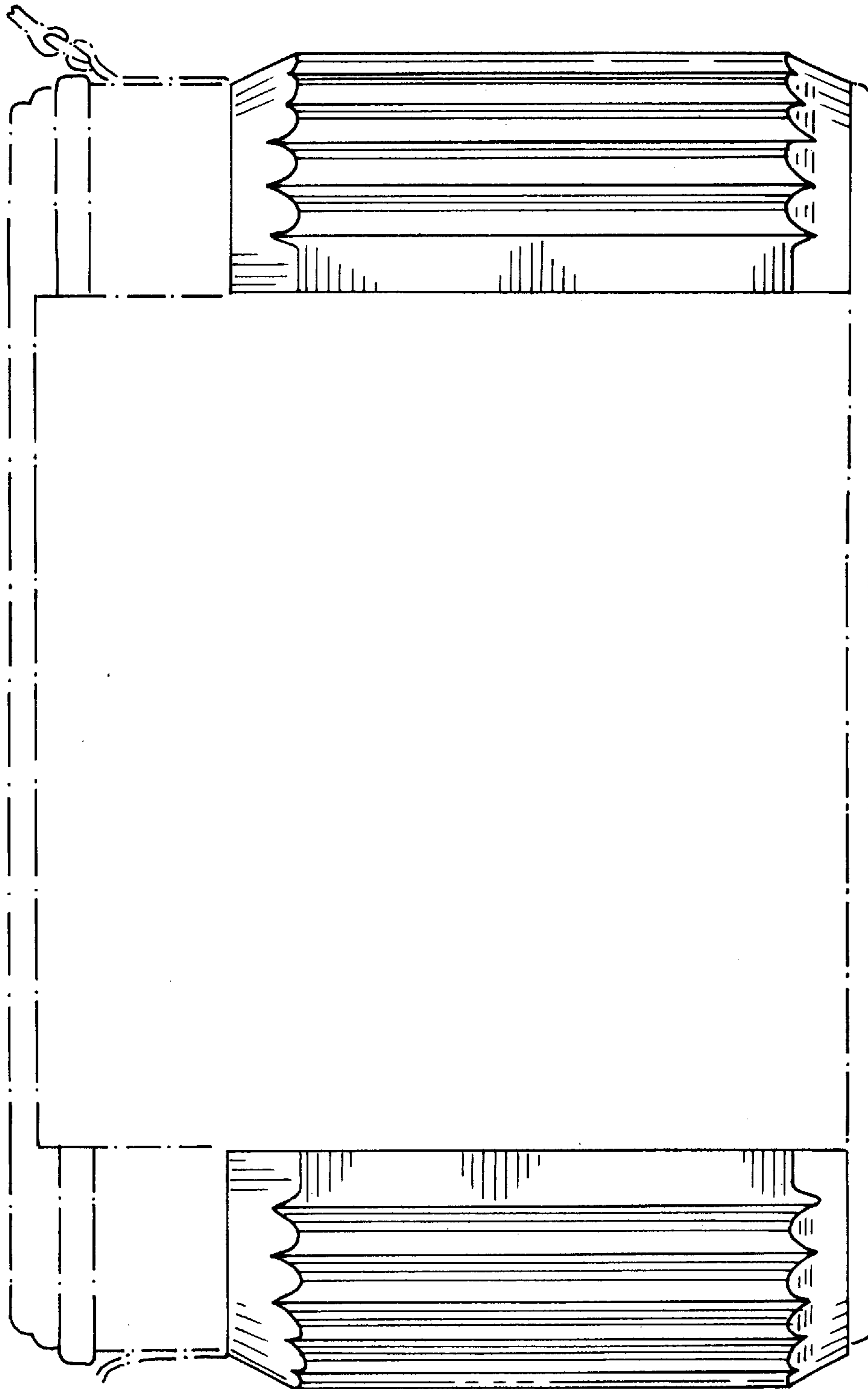

FIG. 3

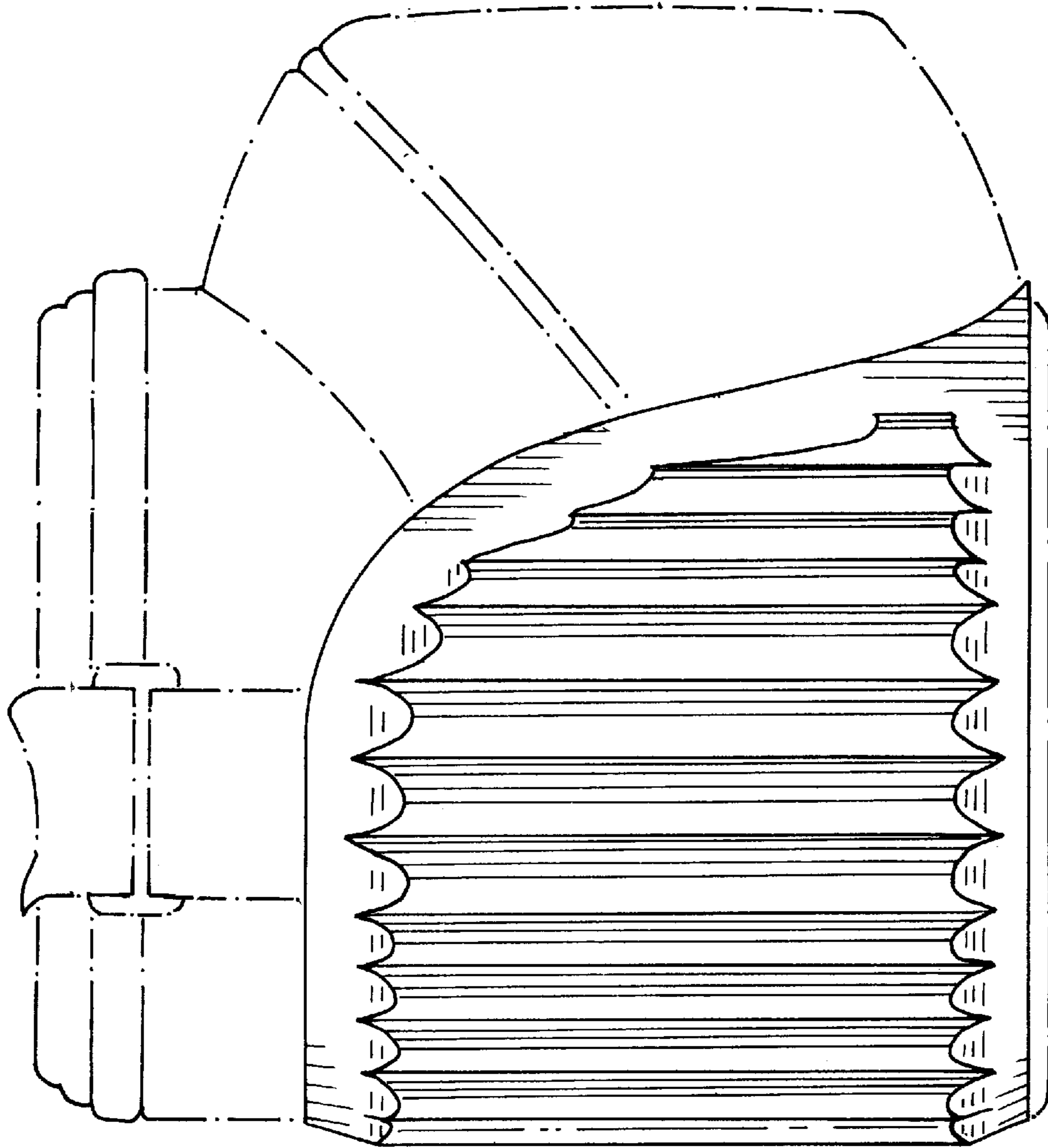

FIG. 4

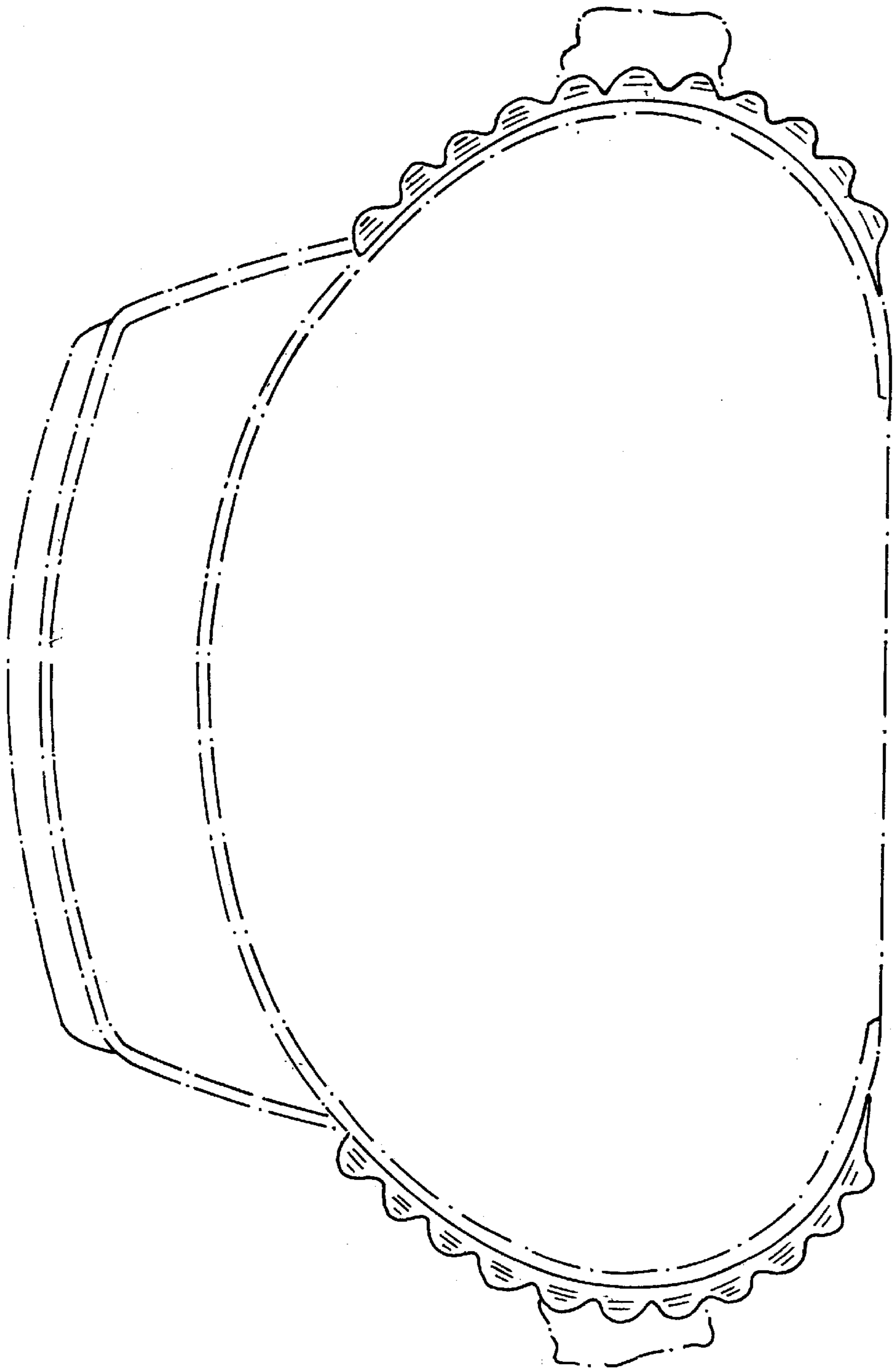

FIG. 5

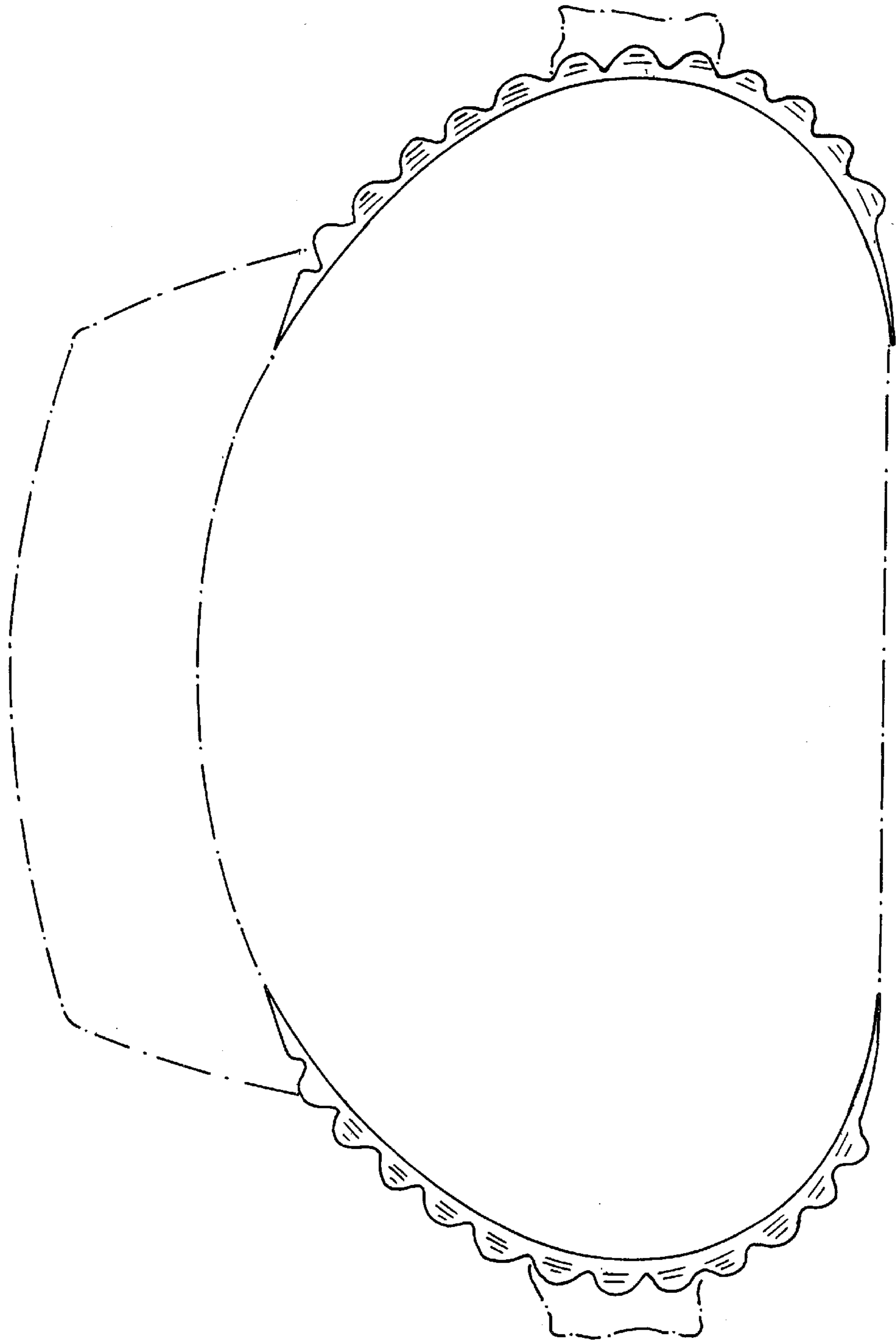

FIG. 6