



US00D419368S

United States Patent [19]

[11] **Patent Number: Des. 419,368**

Geelen et al.

[45] **Date of Patent: ** Jan. 25, 2000**

[54] **COVER FOR COOKING VESSEL**

DESCRIPTION

[75] Inventors: **Jean-Pierre F.M. Geelen**, Hasselt; **Robert H.C.M. Daenen**, Herne; **Johan M.J.K. Mortier**, Grimminge; **Jean-Marie DeCraim**, Buggenhout, all of Belgium

FIG. 1 is a top, side and front perspective view of a first embodiment of a cover for cooking vessel showing the new design;

[73] Assignee: **Dart Industries inc.**, Orlando, Fla.

FIG. 2 is a bottom, side and front perspective view thereof;

[**] Term: **14 Years**

FIG. 3 is a front elevation view thereof;

[21] Appl. No.: **29/096,230**

FIG. 4 is a rear elevation view thereof;

[22] Filed: **Nov. 6, 1998**

FIG. 5 is a right side elevation view thereof;

[51] **LOC (7) Cl.** **07-02**

FIG. 6 is a left side elevation view thereof;

[52] **U.S. Cl.** **D7/391**

FIG. 7 is a top plan view thereof; and

[58] **Field of Search** D7/354-361, 391, D7/393; 16/118, 121; 220/573.1, 752, 912

FIG. 8 is a bottom plan view thereof;

[56] **References Cited**

FIG. 9 is a top, side and front perspective view of a second embodiment of a cover for cooking vessel showing the new design;

U.S. PATENT DOCUMENTS

D. 281,050	10/1985	Cesaroni et al.	D7/360
D. 304,282	10/1989	Feimer et al.	D7/391
D. 400,393	11/1998	Ranzoni	D7/360
4,285,441	8/1981	Ziskind	220/231
5,927,183	7/1999	Lee	99/337

FIG. 10 is a bottom, side and front perspective view thereof;

OTHER PUBLICATIONS

Permanent® Model MC2000 Cookware Knob Assembly, The West Bend Company, West Bend, IN, 1995.

FIG. 11 is a front elevation view thereof;

Primary Examiner—Caron D. Veynar
Attorney, Agent, or Firm—Taylor J. Ross

FIG. 12 is a rear elevation view thereof;

[57] **CLAIM**

FIG. 13 is a right side elevation view thereof;

The ornamental design for a cover for cooking vessel, as shown and described.

FIG. 14 is a left side elevation view thereof;

FIG. 15 is a top plan view thereof; and

FIG. 16 is a bottom plan view thereof;

FIG. 17 is a top, side and front perspective view of a third embodiment of a cover for cooking vessel showing the new design;

FIG. 18 is a bottom, side and front perspective view thereof;

FIG. 19 is a front elevation view thereof;

FIG. 20 is a rear elevation view thereof;

FIG. 21 is a right side elevation view thereof;

FIG. 22 is a left side elevation view thereof;

FIG. 23 is a top plan view thereof; and

FIG. 24 is a bottom plan view thereof.

1 Claim, 9 Drawing Sheets

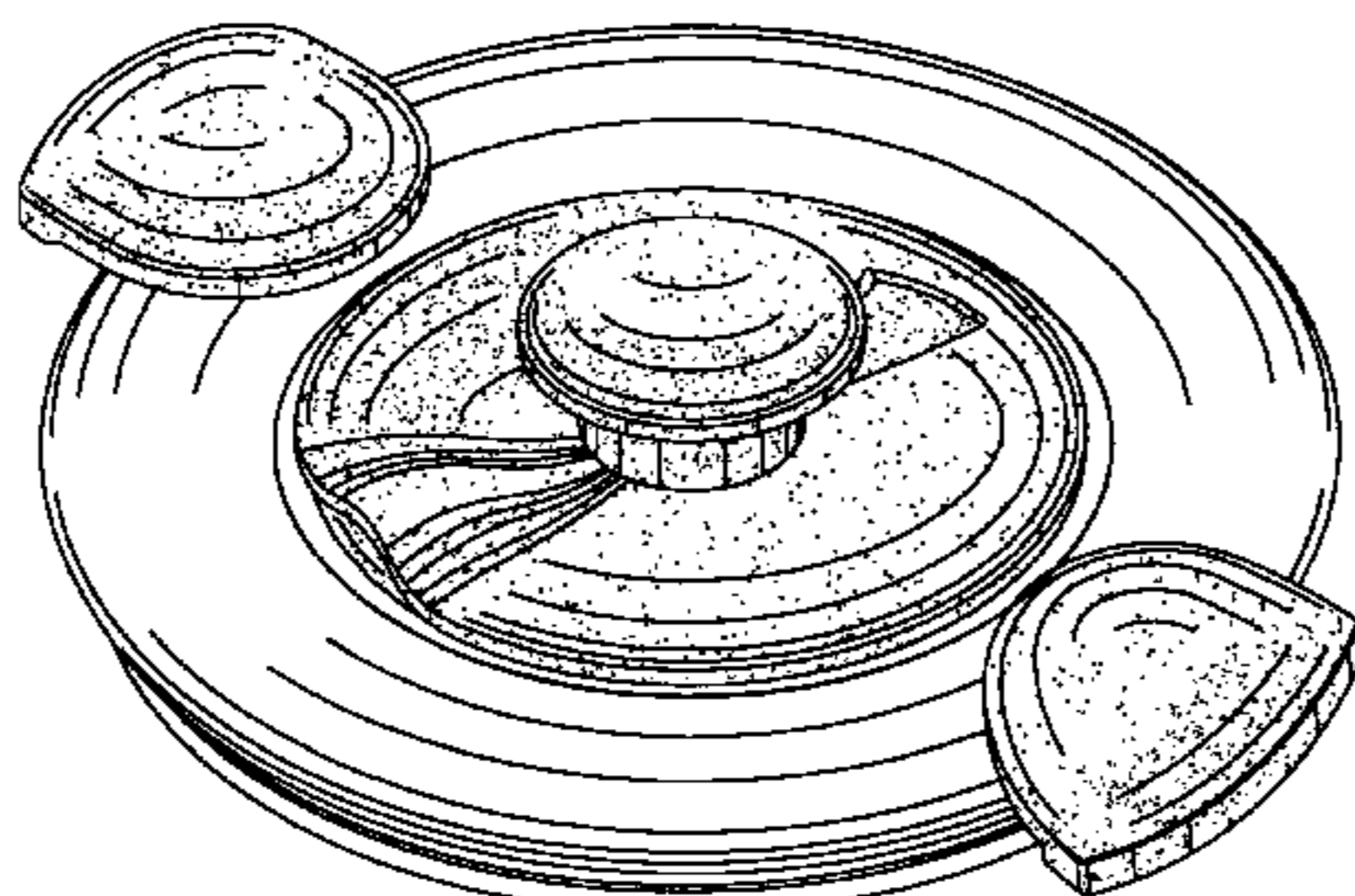
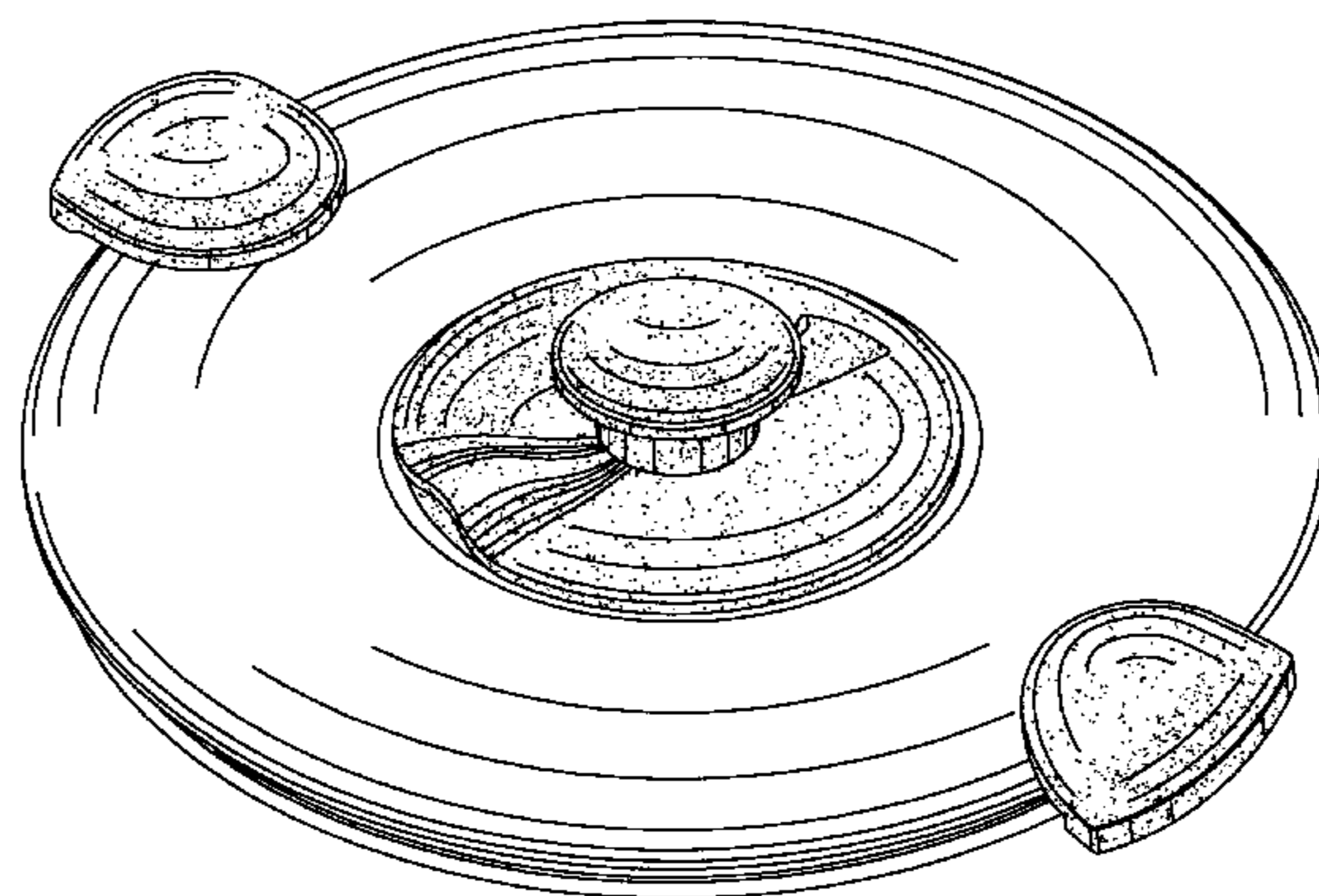

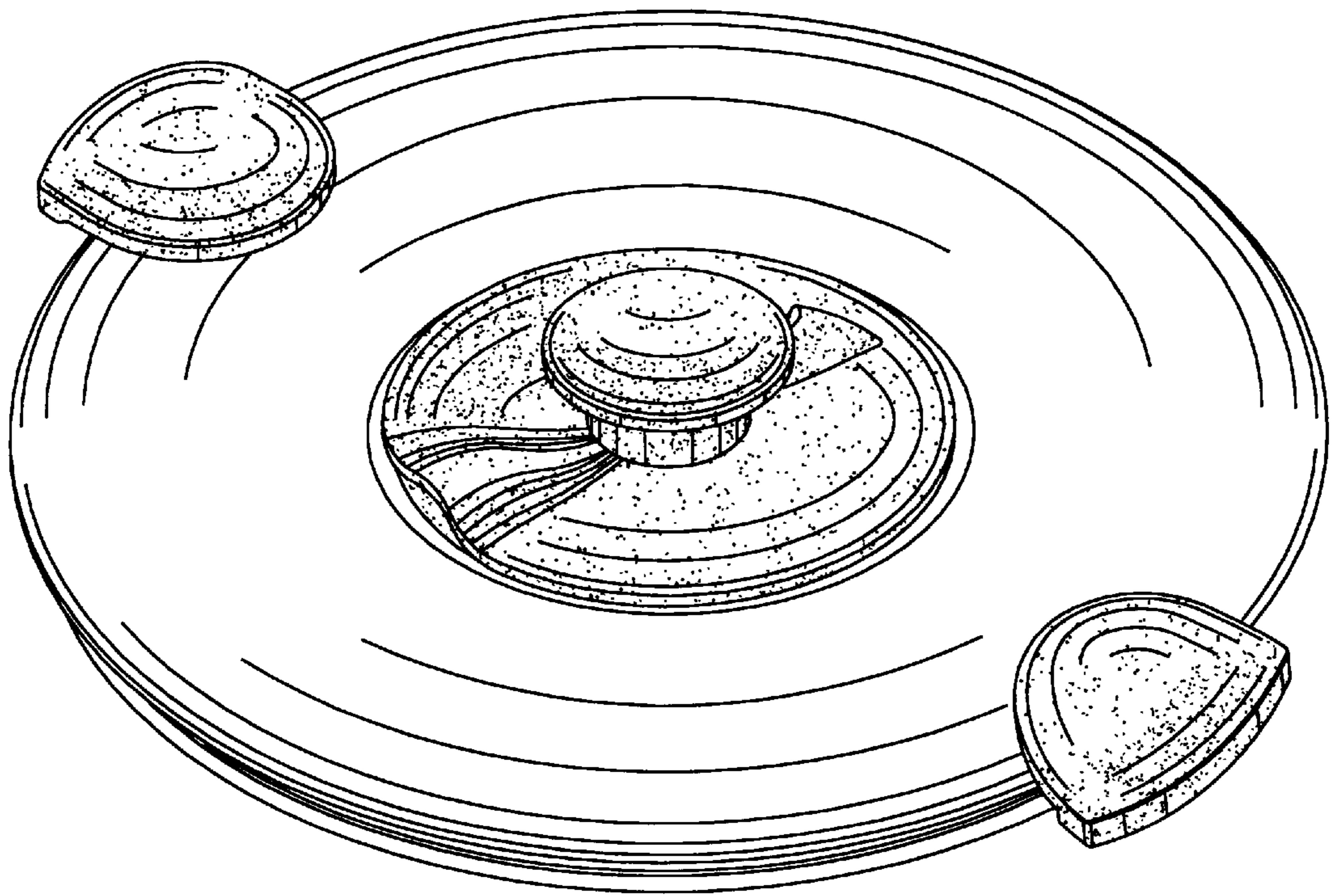

FIG. 1

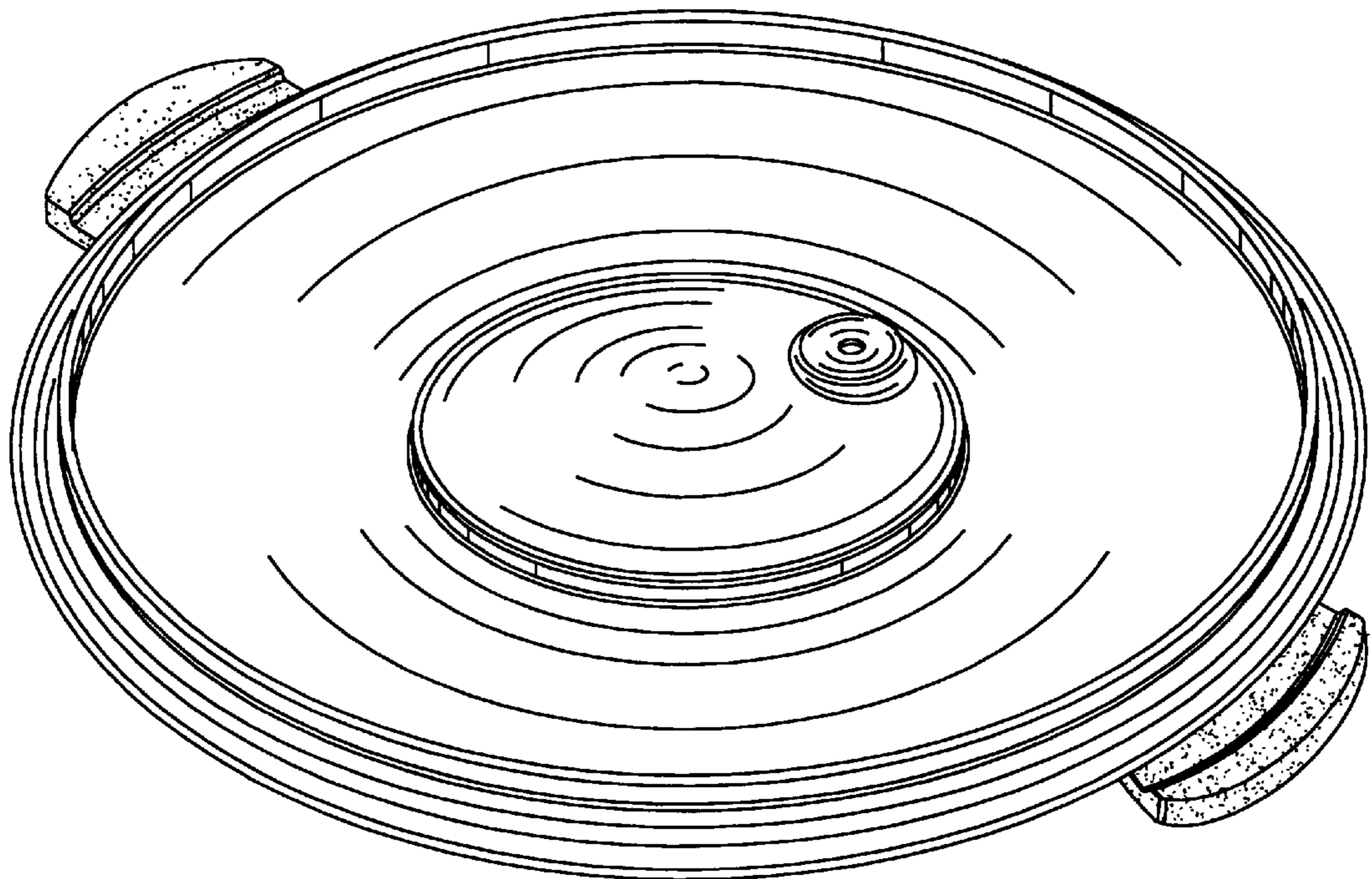

FIG. 2

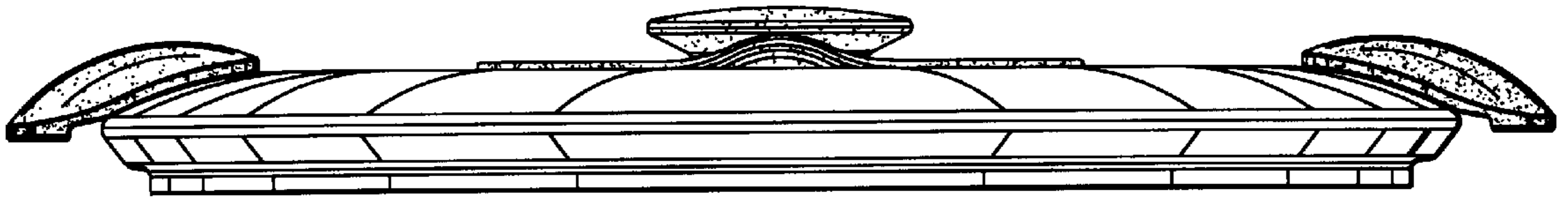

FIG. 3

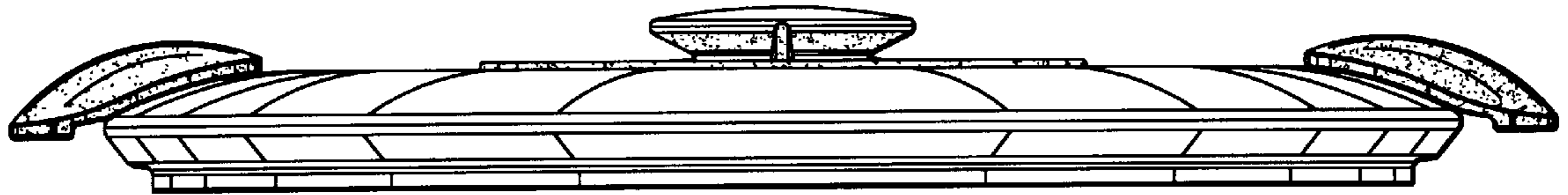

FIG. 4

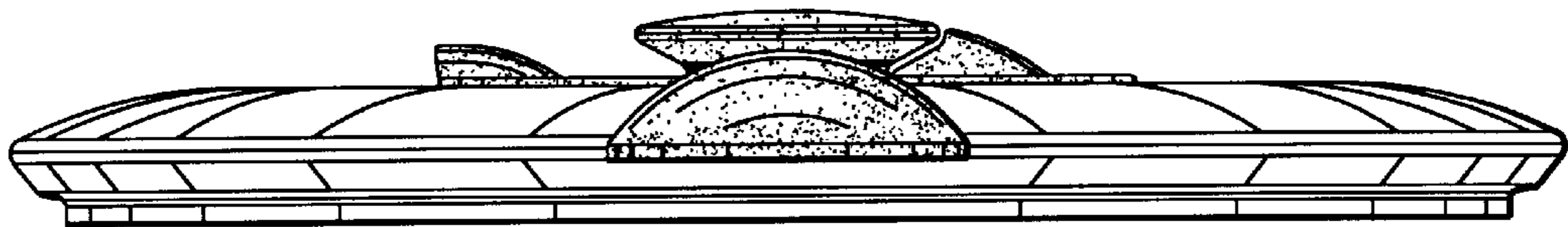

FIG. 5

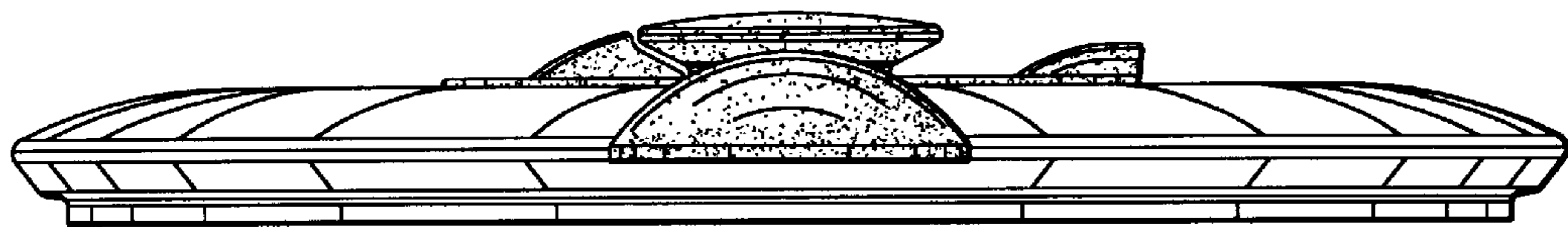

FIG. 6

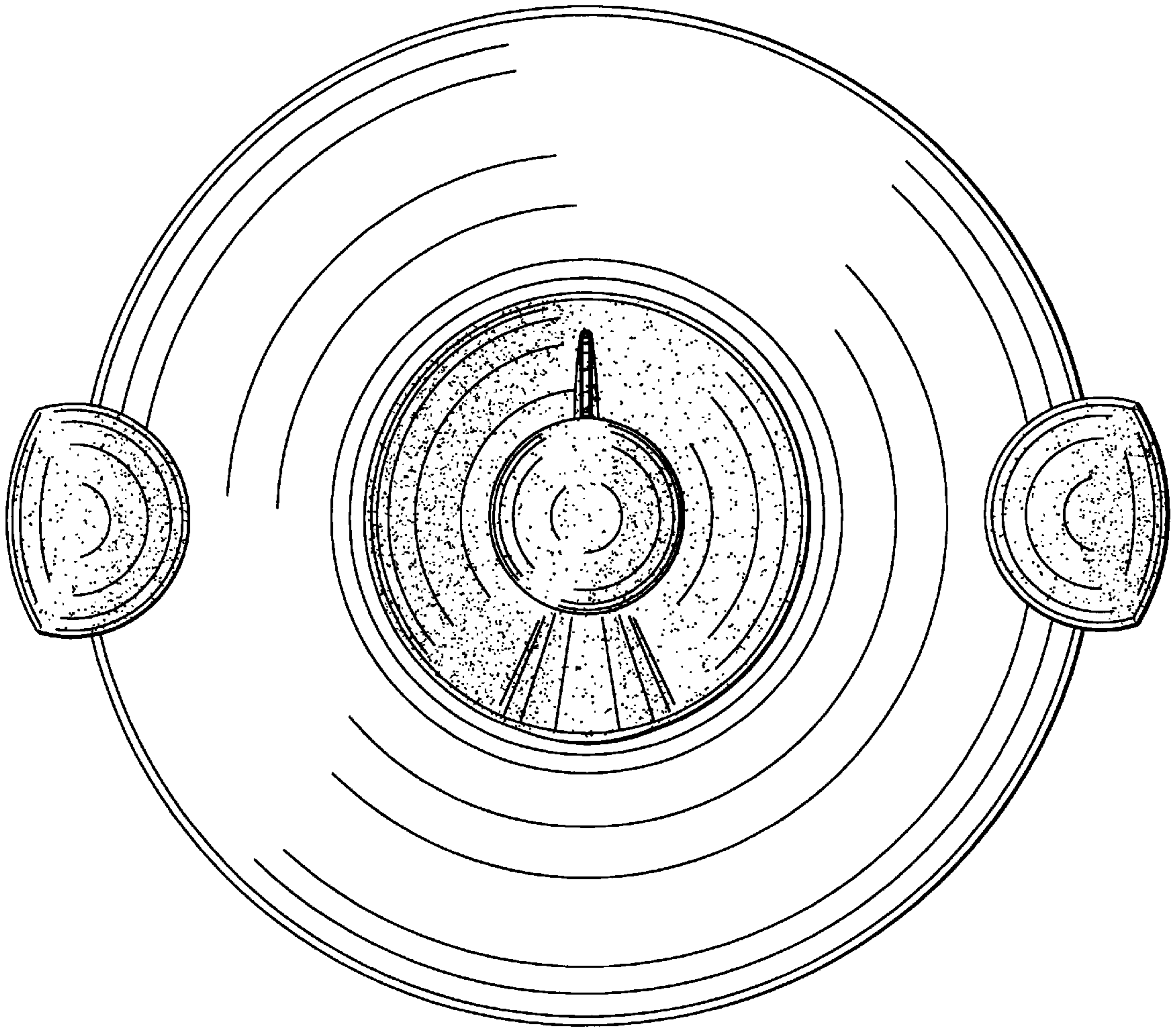

FIG. 7

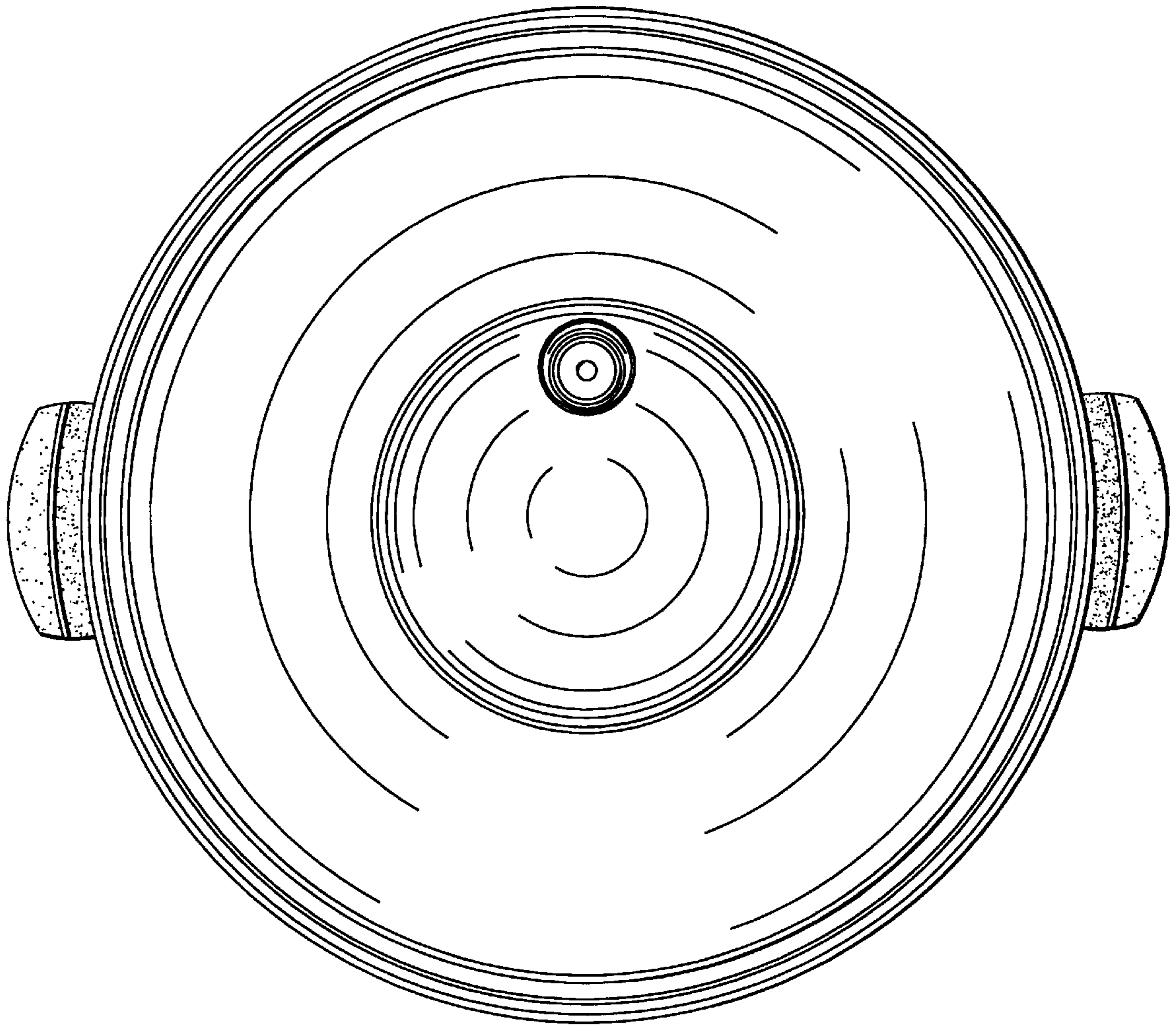

FIG. 8

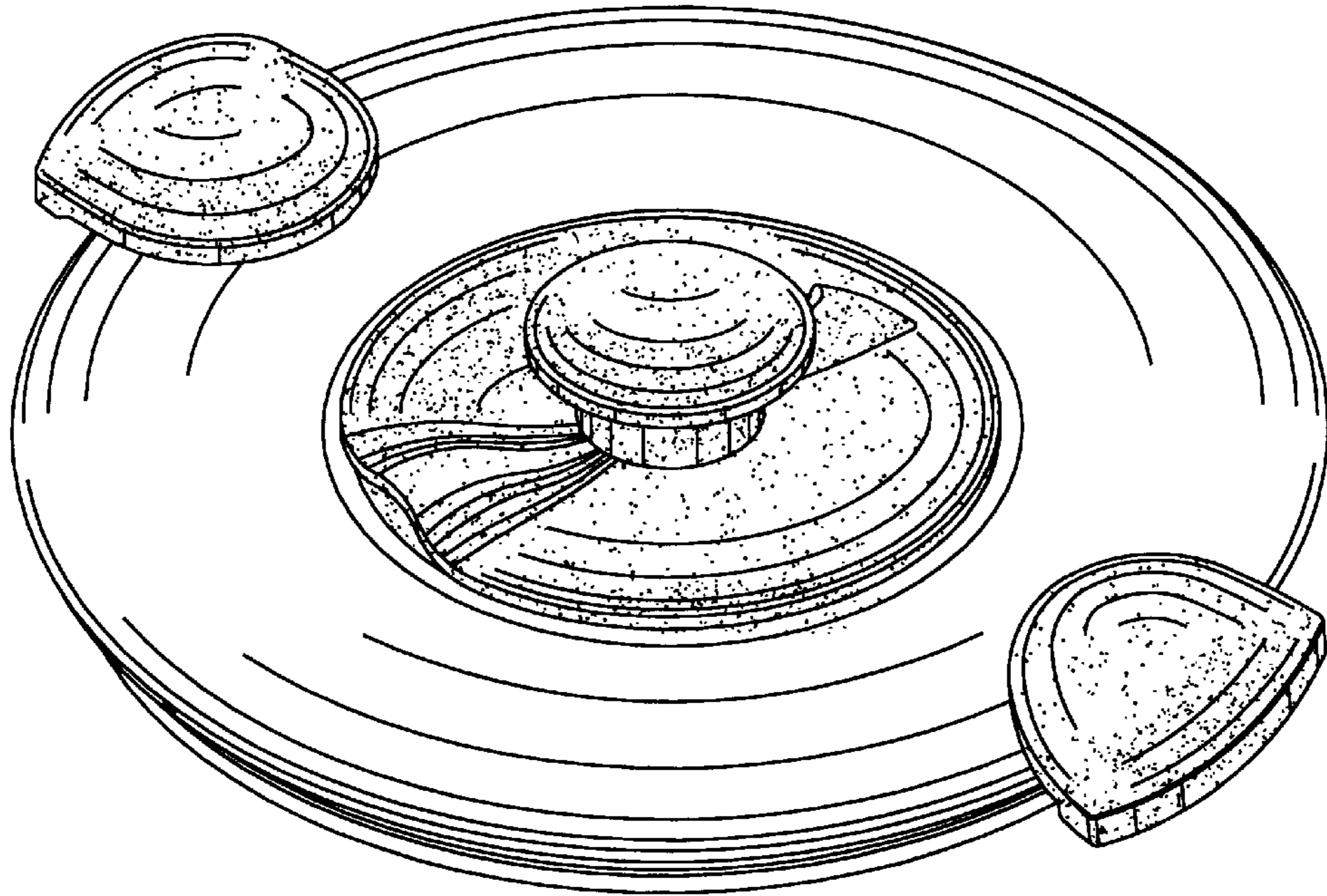

FIG. 9

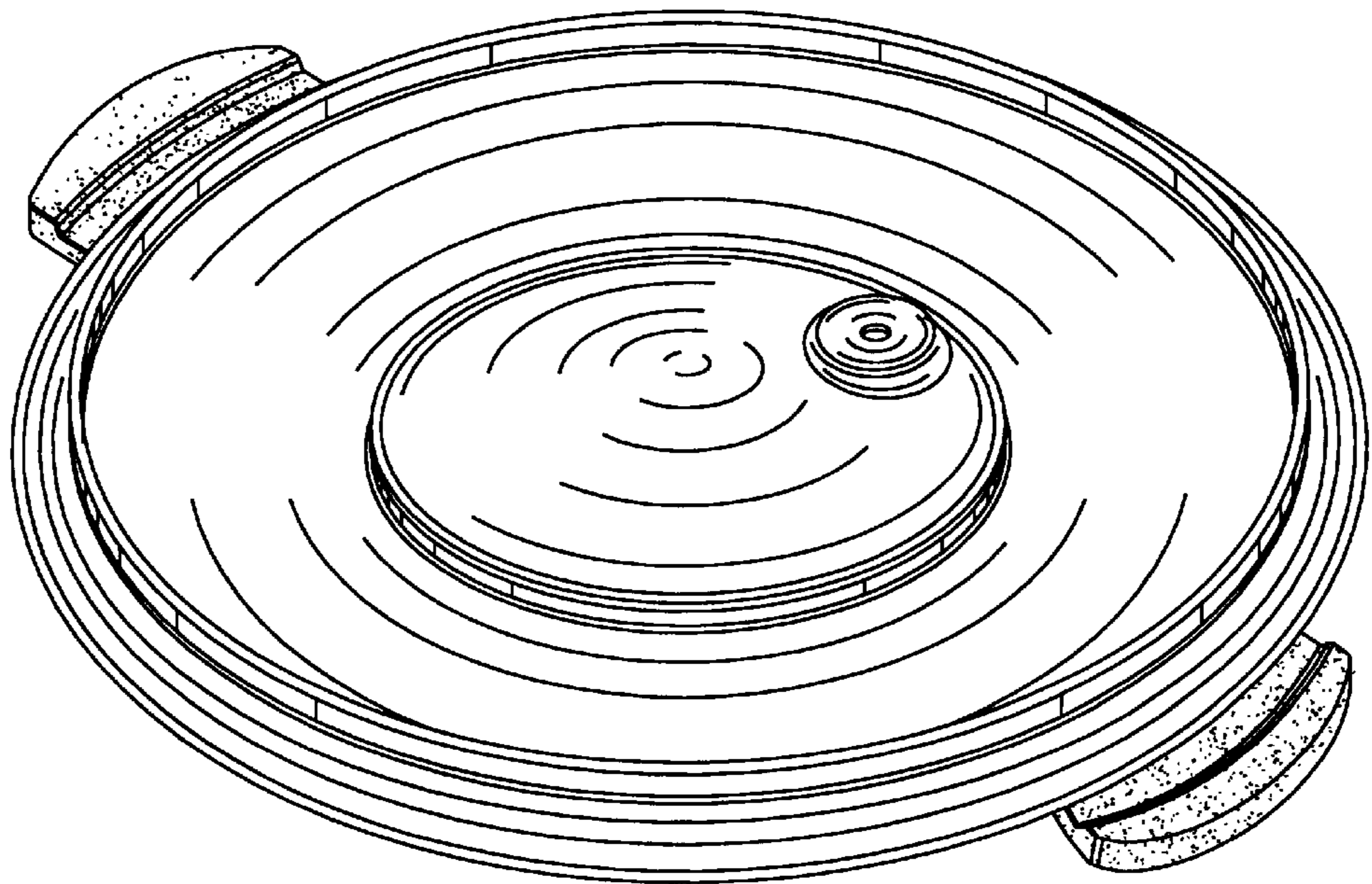

FIG. 10

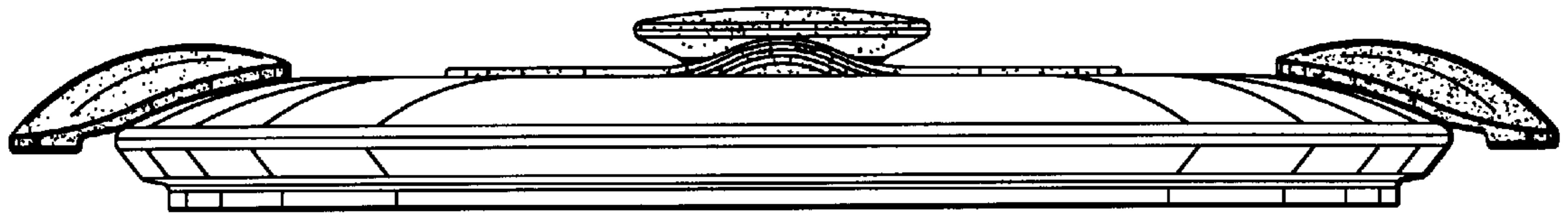

FIG. 11

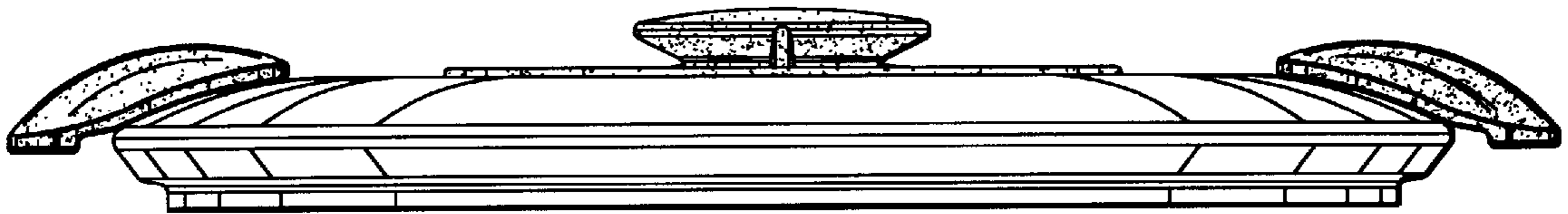

FIG. 12



FIG. 13



FIG. 14

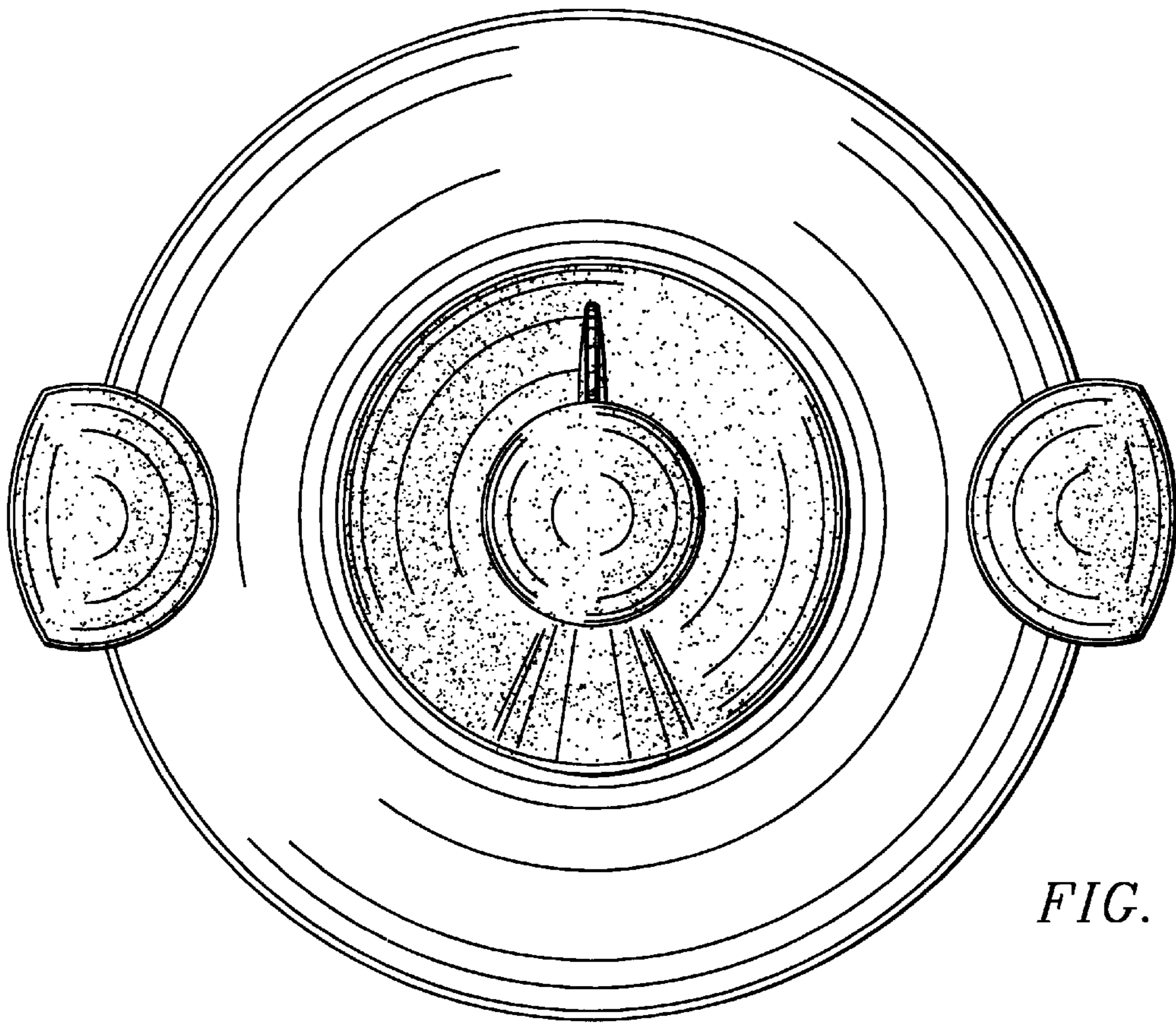

FIG. 15

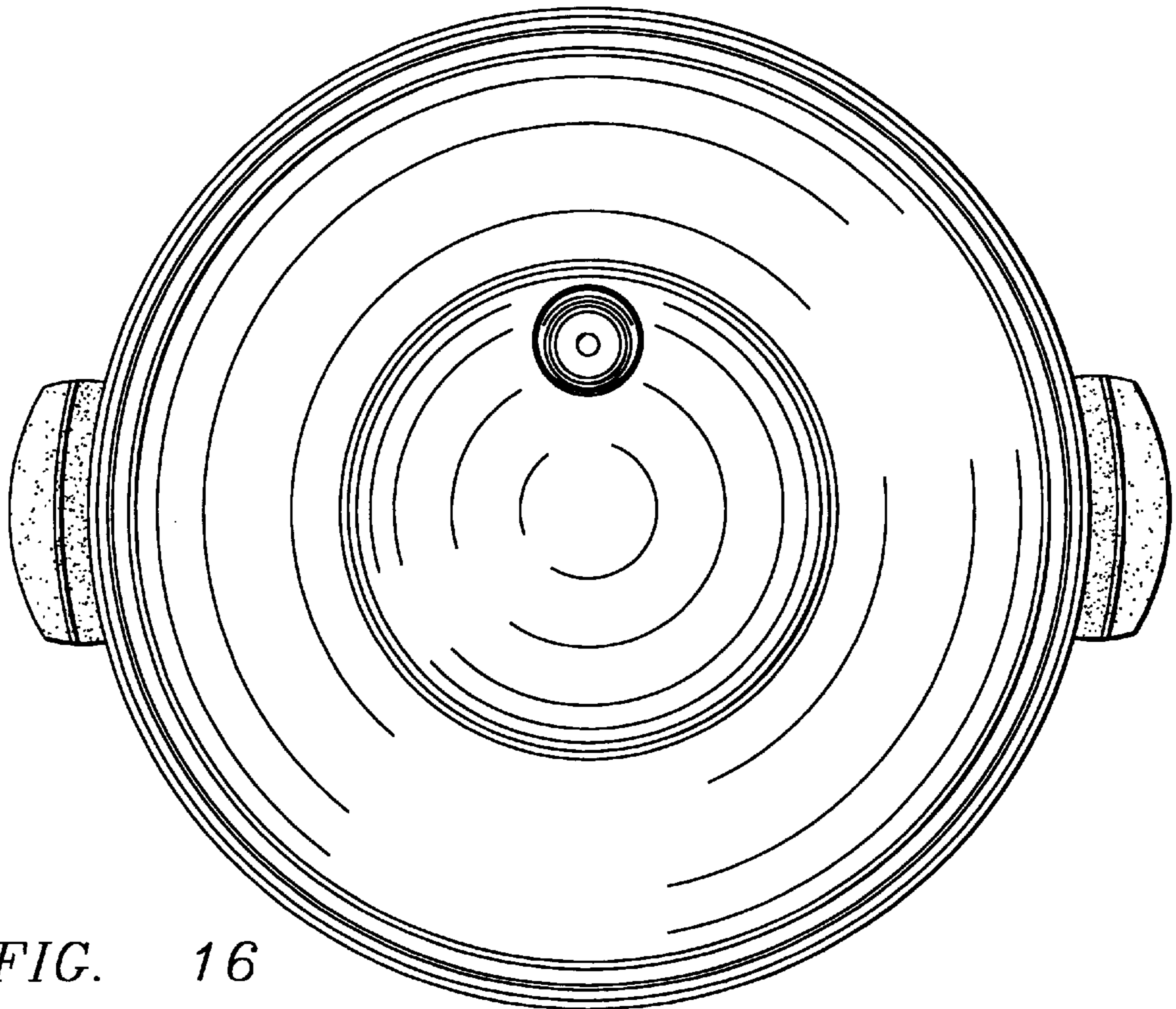

FIG. 16

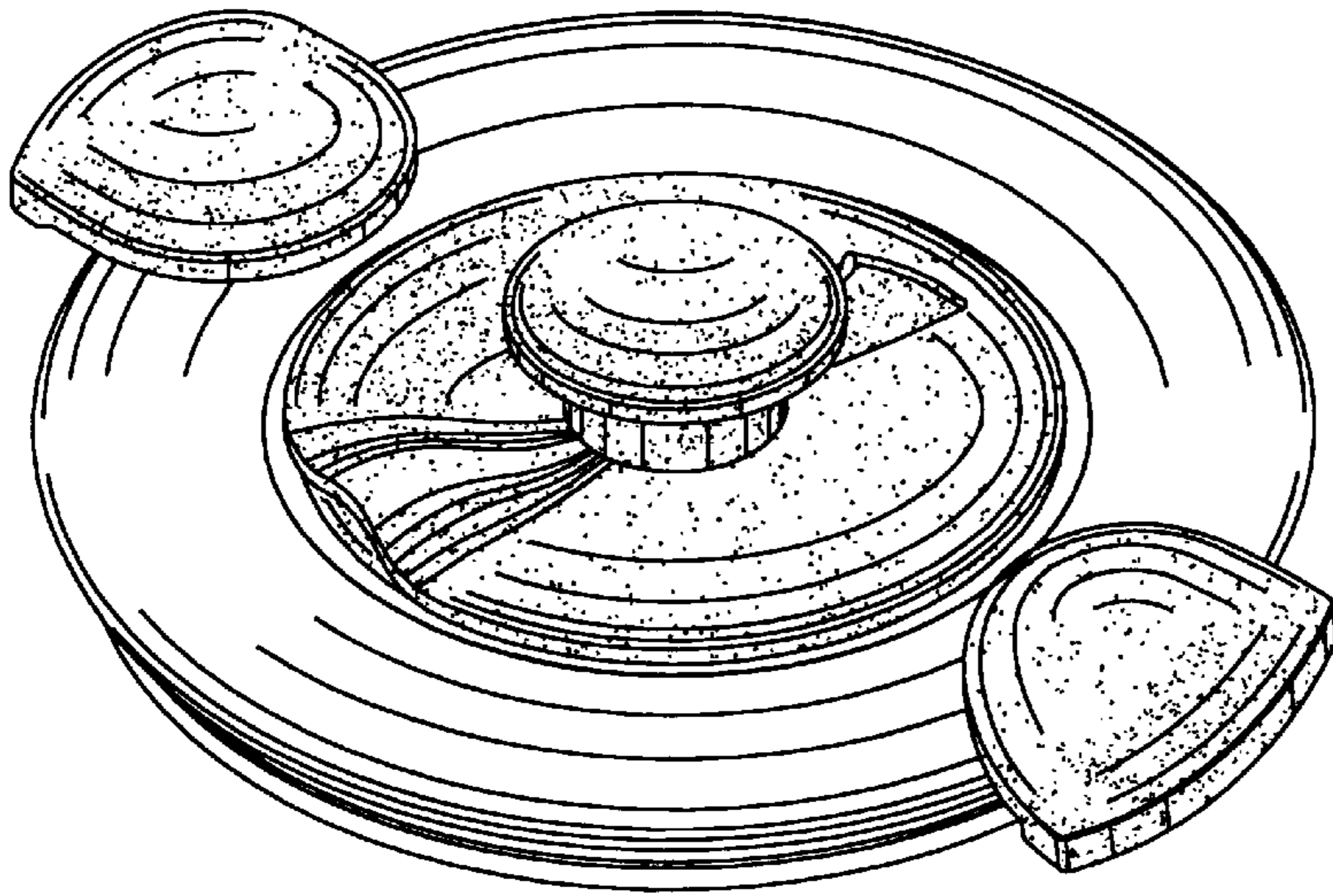

FIG. 17

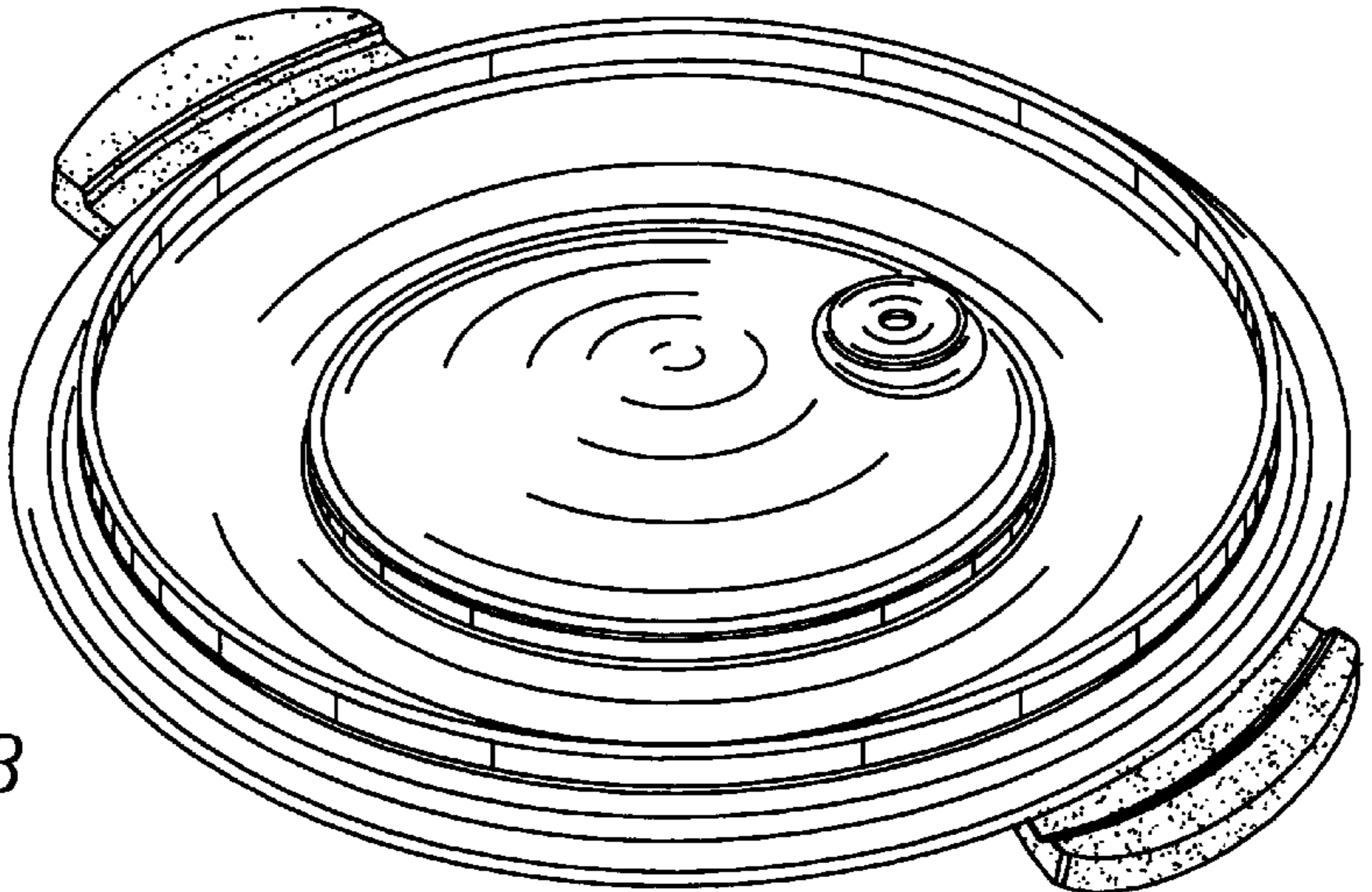

FIG. 18

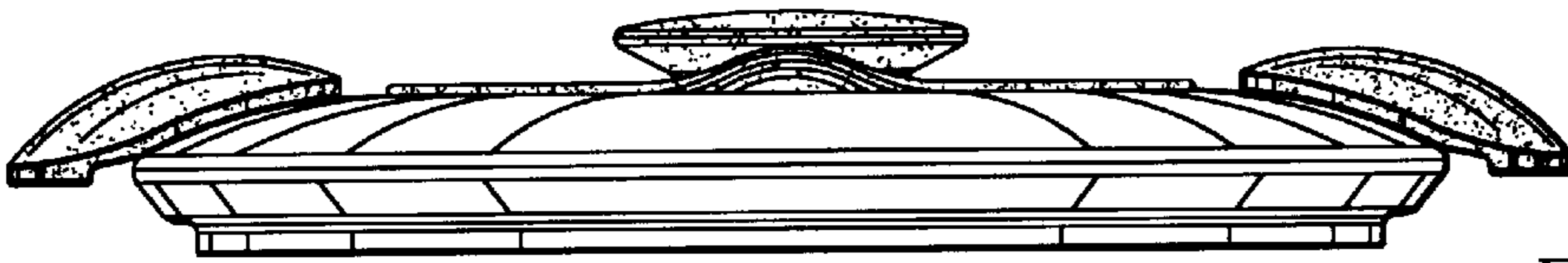

FIG. 19

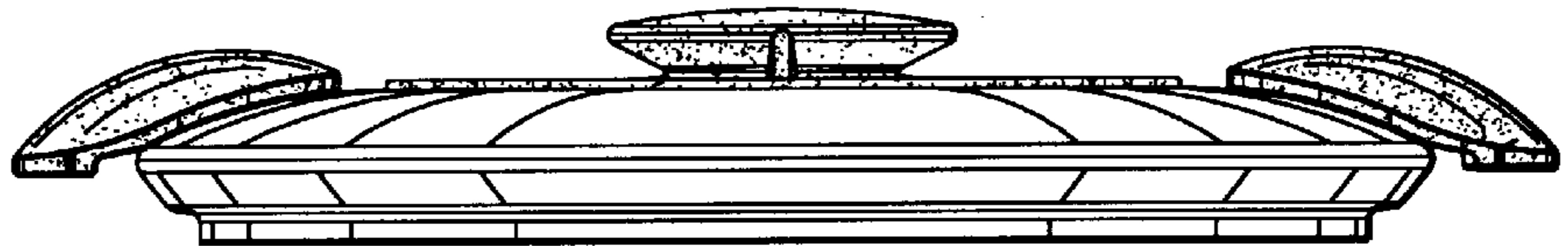

FIG. 20



FIG. 21

FIG. 22

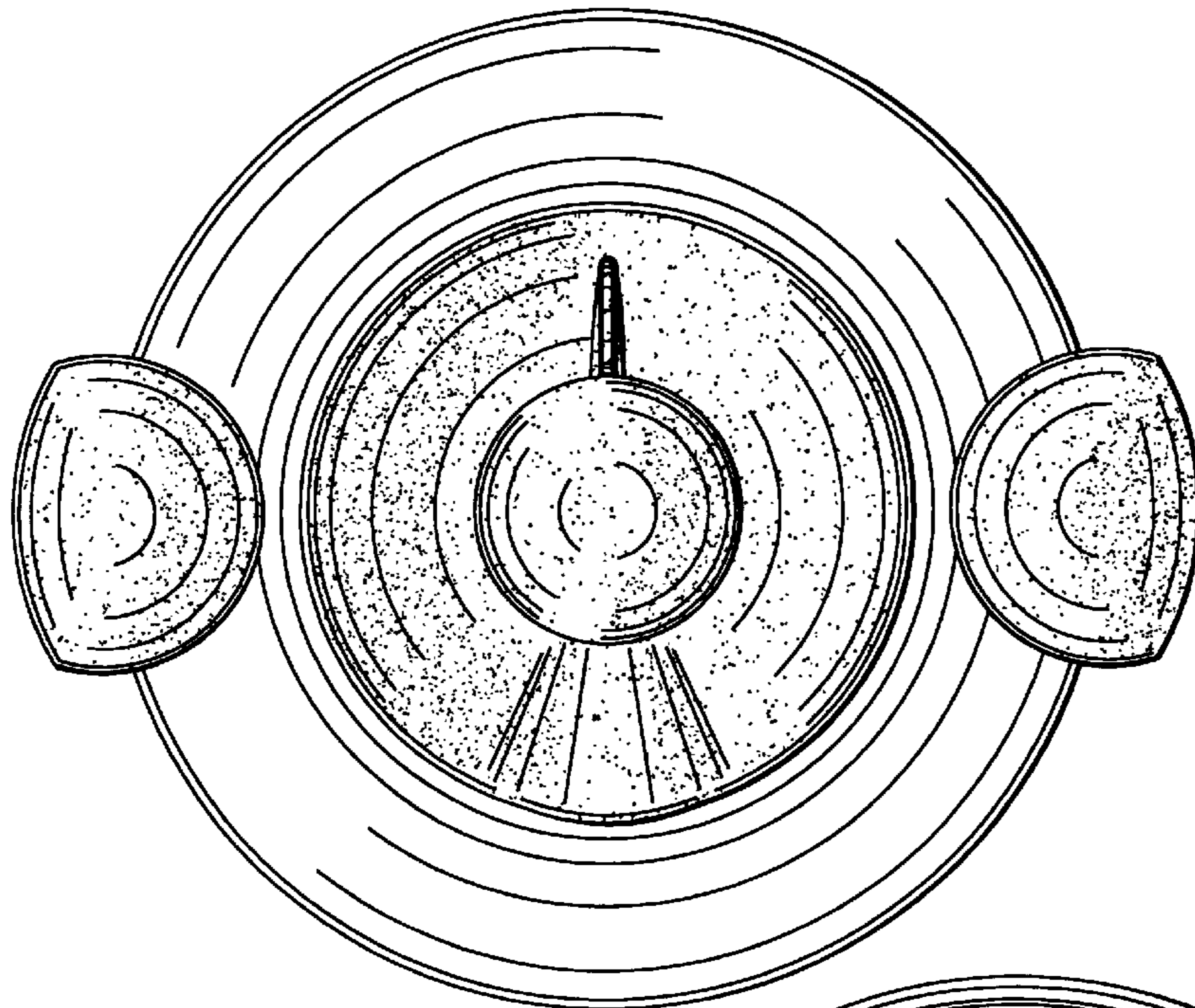
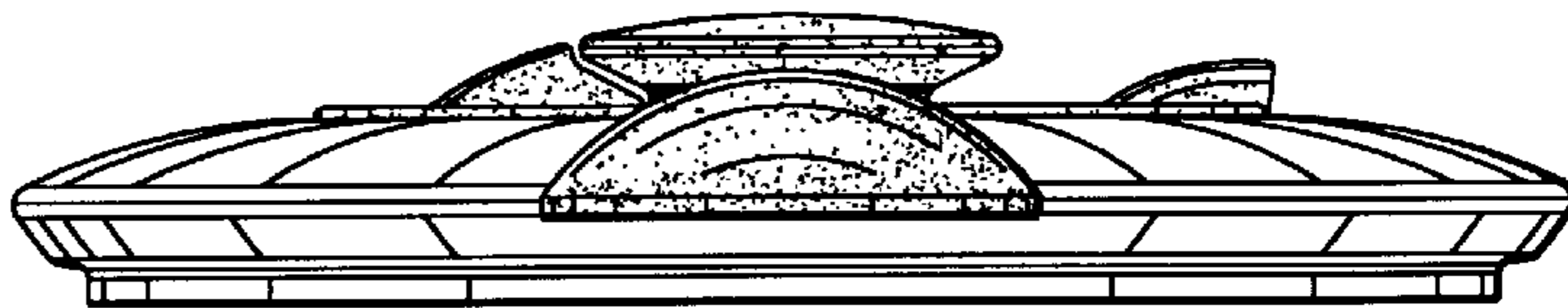

FIG. 23

FIG. 24

