



US00D419290S

United States Patent [19]

[11] Patent Number: Des. 419,290

Treyer et al.

[45] Date of Patent: ** Jan. 25, 2000

[54] CASE FOR A PORTABLE TELEPHONE

[75] Inventors: Galina Treyer, Northbrook; Kenneth J. Chung, Lindenhurst; Albert L. Nagele, Wilmette; Jerry Tomaszewski, Addison, all of Ill.

[73] Assignee: Motorola, Inc., Schaumburg, Ill.

[**] Term: 14 Years

[21] Appl. No.: 29/097,005

[22] Filed: Nov. 25, 1998

[51] LOC (7) Cl. 03-01

[52] U.S. Cl. D3/218; D14/253

[58] Field of Search D3/218, 215, 219, D3/224, 226; 224/904, 913, 240, 269, 230; D14/251, 253, 138, 140, 240; 379/446, 443, 449, 450, 454, 455, 419, 420, 428, 440

[56] References Cited

U.S. PATENT DOCUMENTS

D. 339,690	9/1993	Takahashi et al.	D3/218
D. 346,275	4/1994	Hayasaka et al.	D3/218
D. 348,355	7/1994	Scheid et al.	D3/218
D. 351,280	10/1994	Pennington et al.	D3/218
D. 357,577	4/1995	Scheid	D3/218
D. 369,359	4/1996	Wright et al.	D14/253
D. 387,199	12/1997	Nagele et al. .	
D. 389,641	1/1998	McCutcheon et al. .	
D. 392,097	3/1998	Pottala et al.	D3/218
D. 394,862	6/1998	Fischer	D14/253
D. 406,191	3/1999	Phillips et al.	D3/218
5,659,612	8/1997	Wang	379/446

Primary Examiner—Jeffrey Asch
Attorney, Agent, or Firm—Kevin D. Kaschke; Rolland R. Hackbart

[57] CLAIM

The ornamental design for a case for a portable telephone, as shown and described.

DESCRIPTION

FIG. 1 is a left, front and bottom side perspective view of a

first embodiment of a case for a portable telephone showing our new design;

FIG. 2 is a top side elevation view of our new design, as shown in FIG. 1;

FIG. 3 is a left side elevation view of our new design, as shown in FIG. 1;

FIG. 4 is a front side elevation view of our new design, as shown in FIG. 1;

FIG. 5 is a right side elevation view of our new design, as shown in FIG. 1;

FIG. 6 is a rear side elevation view of our new design, as shown in FIG. 1;

FIG. 7 is a bottom side elevation view of our new design, as shown in FIG. 1;

FIG. 8 is a left, front and bottom side perspective view of a second embodiment of a case for a portable telephone showing our new design;

FIG. 9 is a top side elevation view of our new design, as shown in FIG. 8;

FIG. 10 is a left side elevation view of our new design, as shown in FIG. 8;

FIG. 11 is a front side elevation view of our new design, as shown in FIG. 8;

FIG. 12 is a right side elevation view of our new design, as shown in FIG. 8;

FIG. 13 is a rear side elevation view of our new design, as shown in FIG. 8; and,

FIG. 14 is a bottom side elevation view of our new design, as shown in FIG. 8.

The broken line matter in FIGS. 2, 3, 5, 6 and 7 is for illustrative purposes only and forms no part of the claimed design.

1 Claim, 6 Drawing Sheets

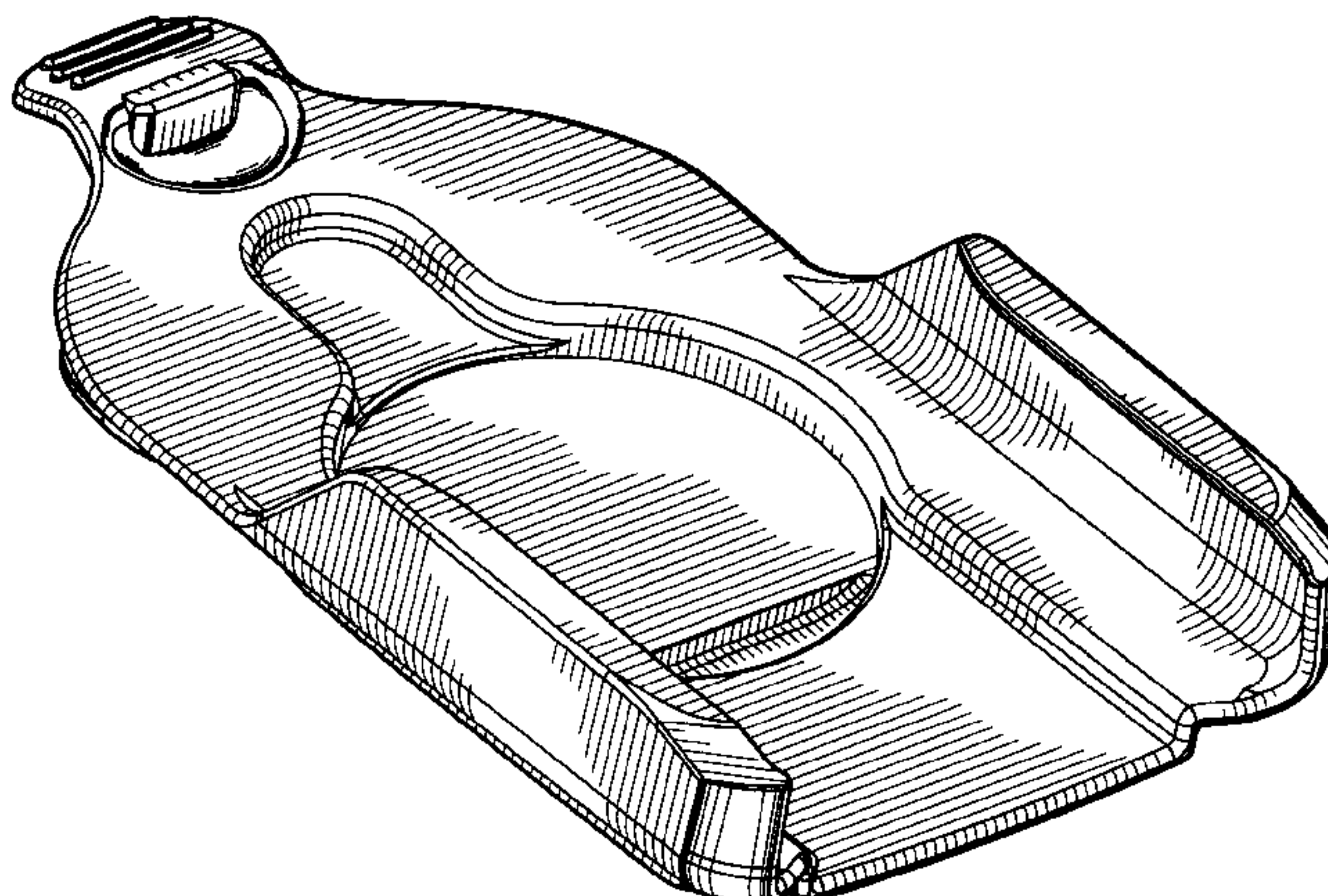

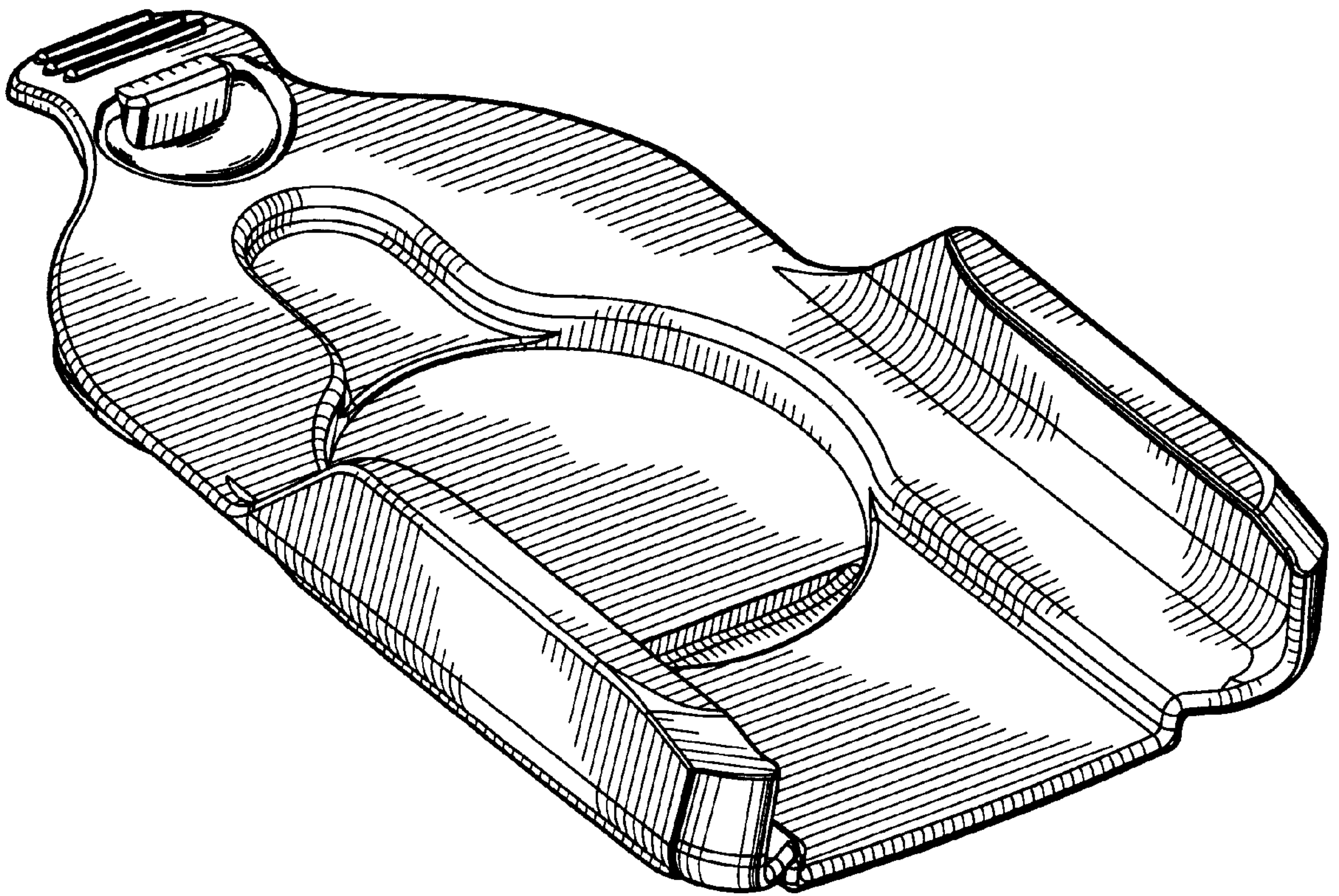

FIG. 1

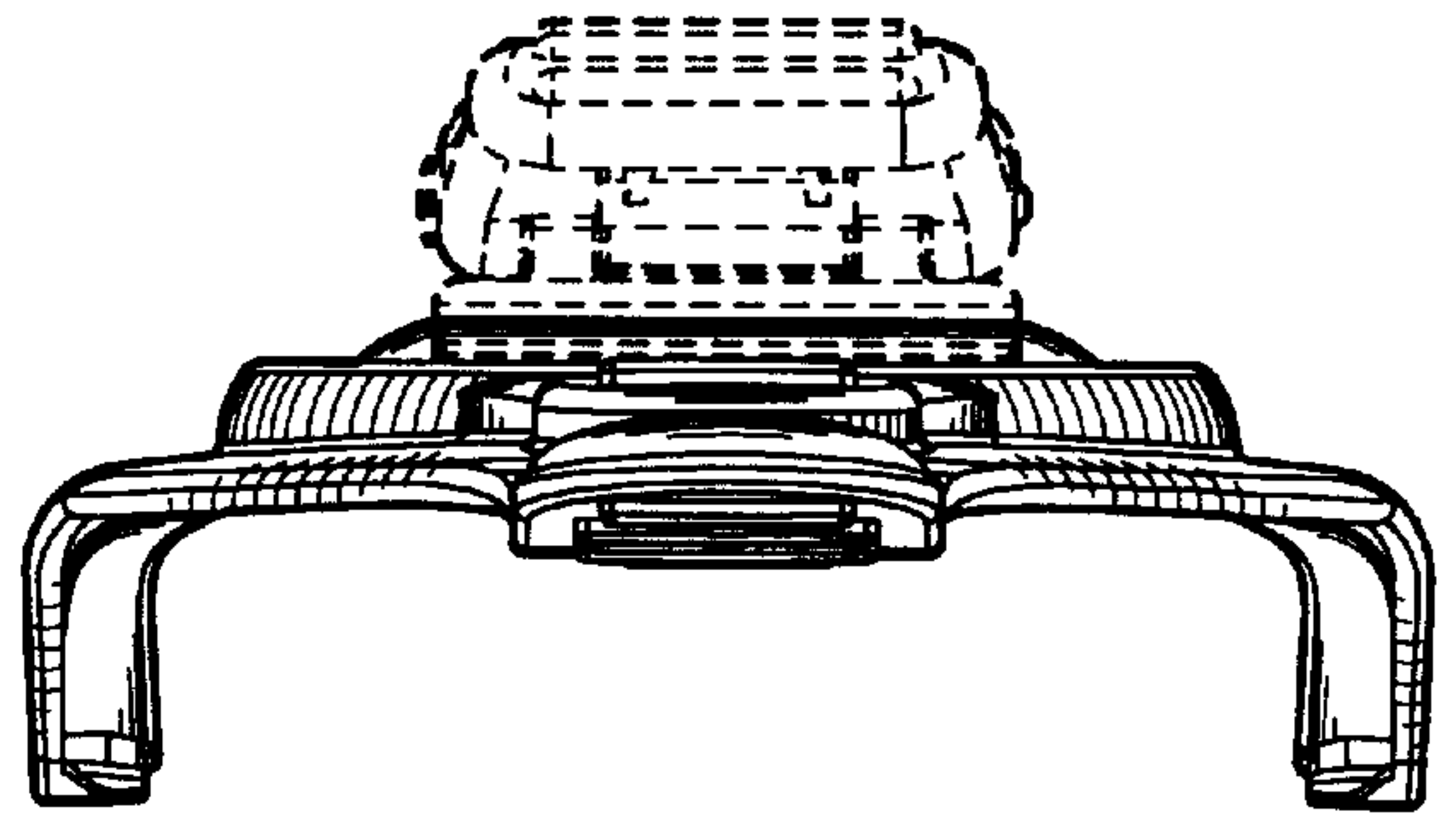

FIG. 2

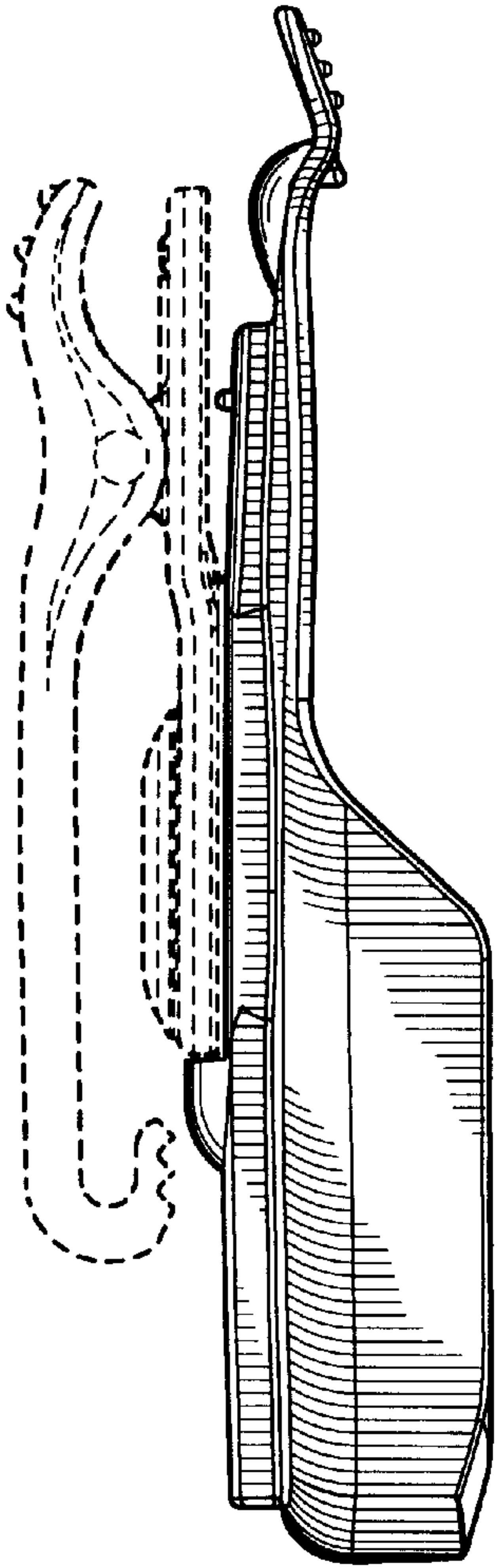

FIG. 3

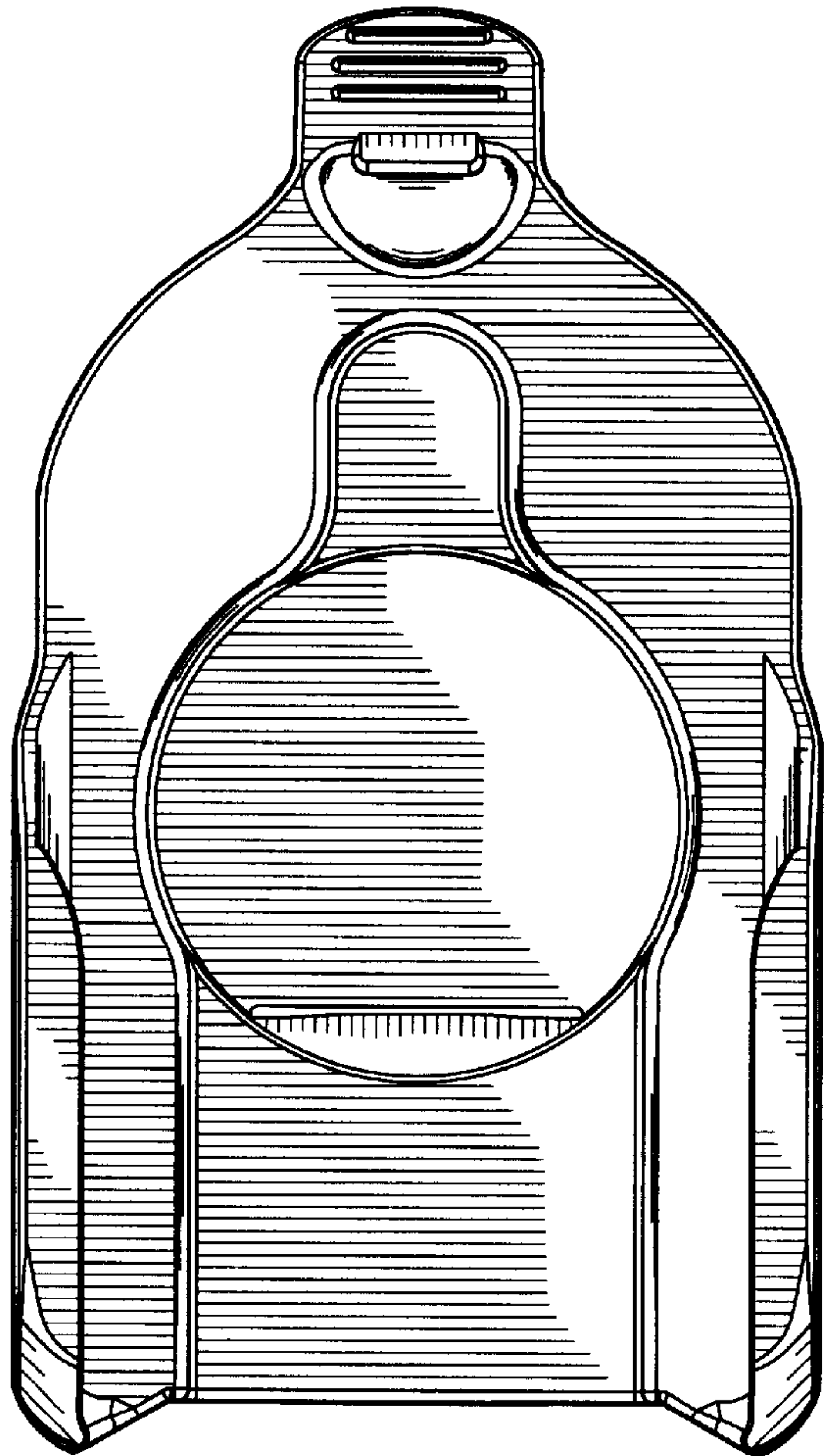

FIG. 4

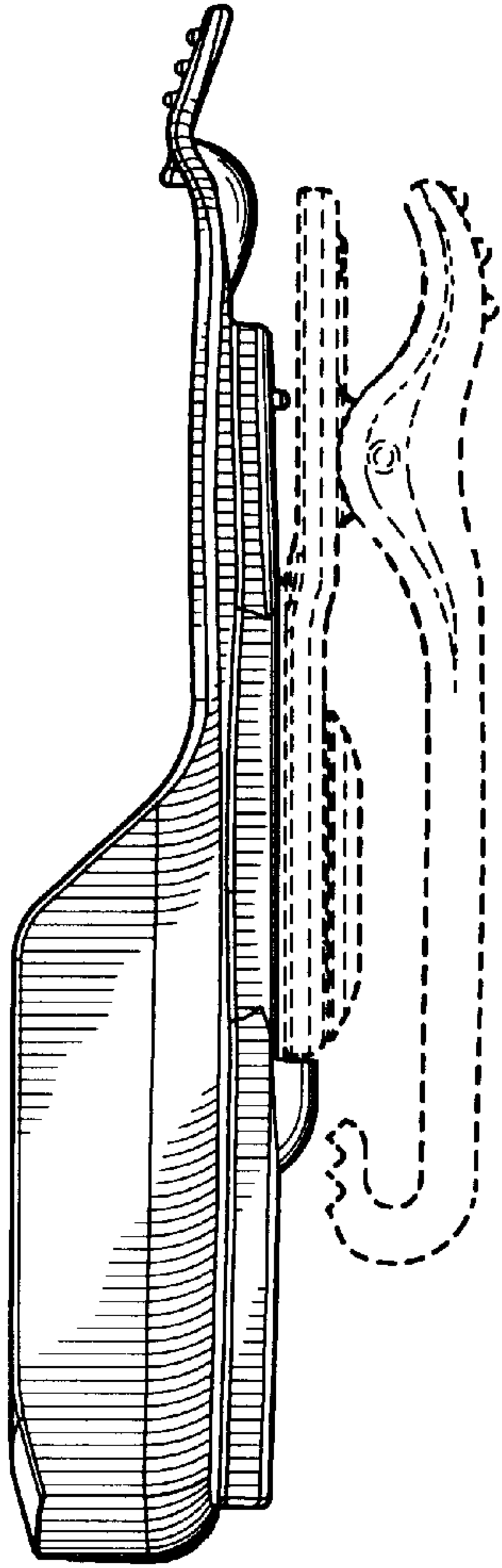

FIG. 5

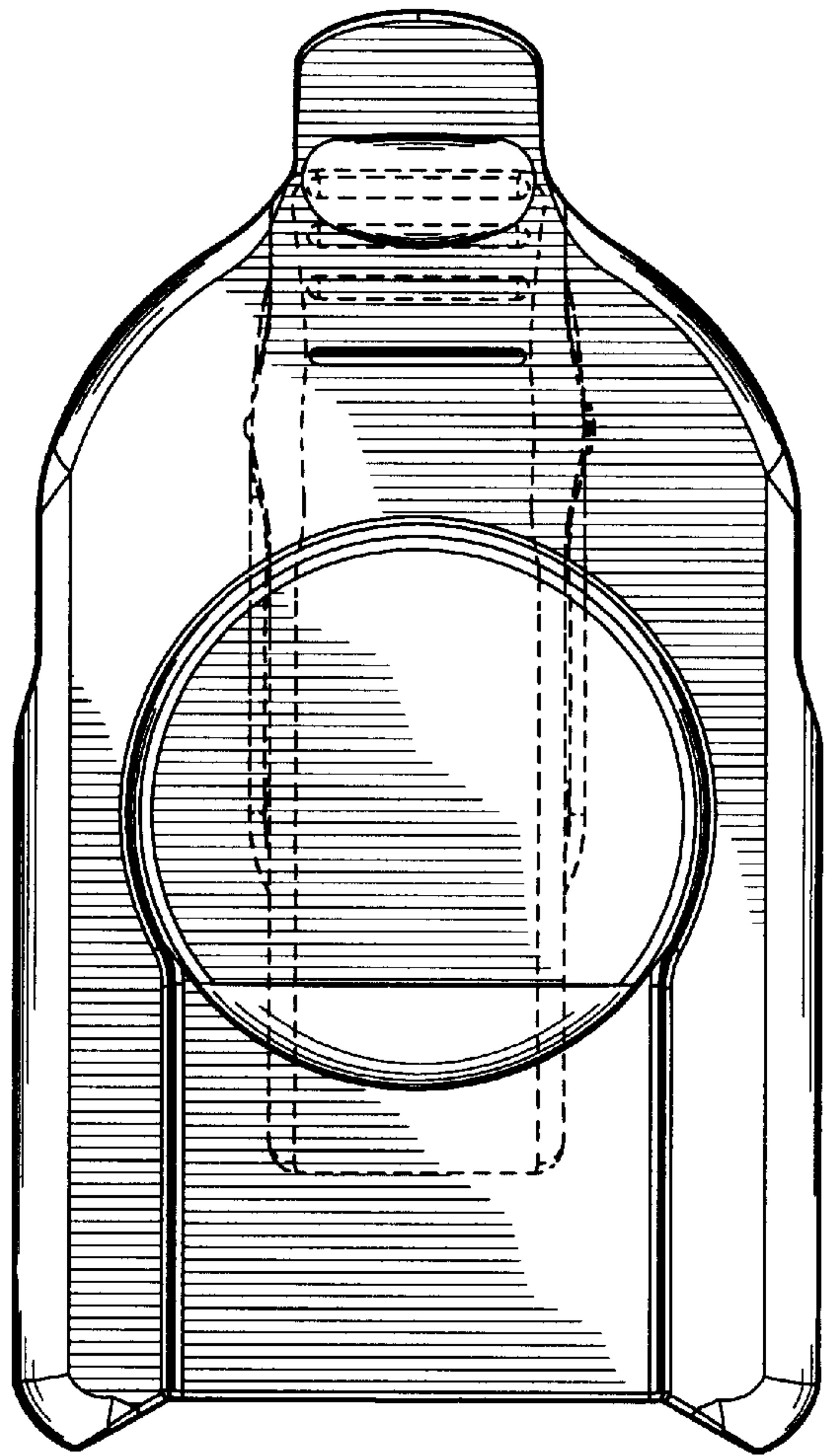

FIG. 6

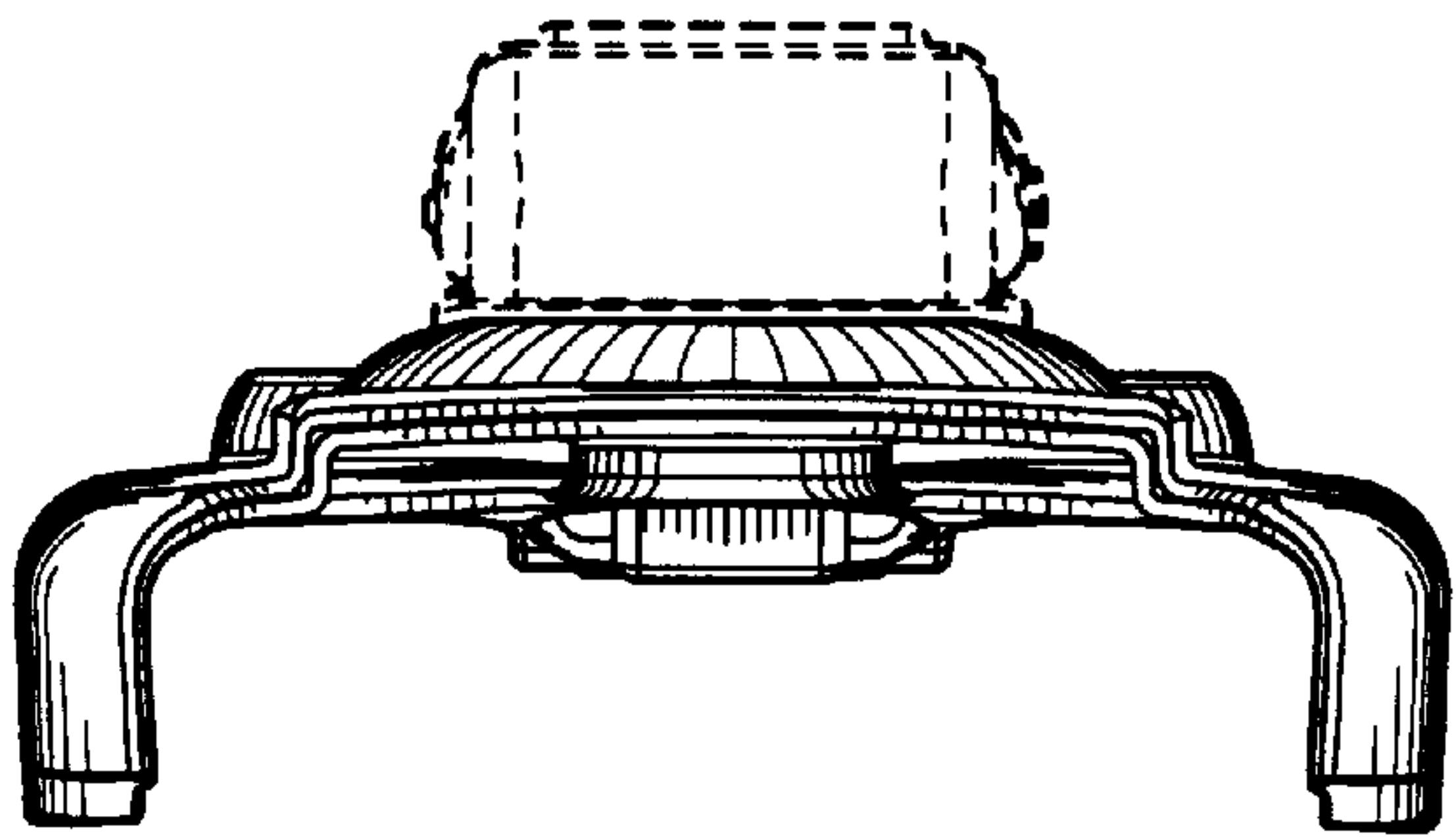

FIG. 7

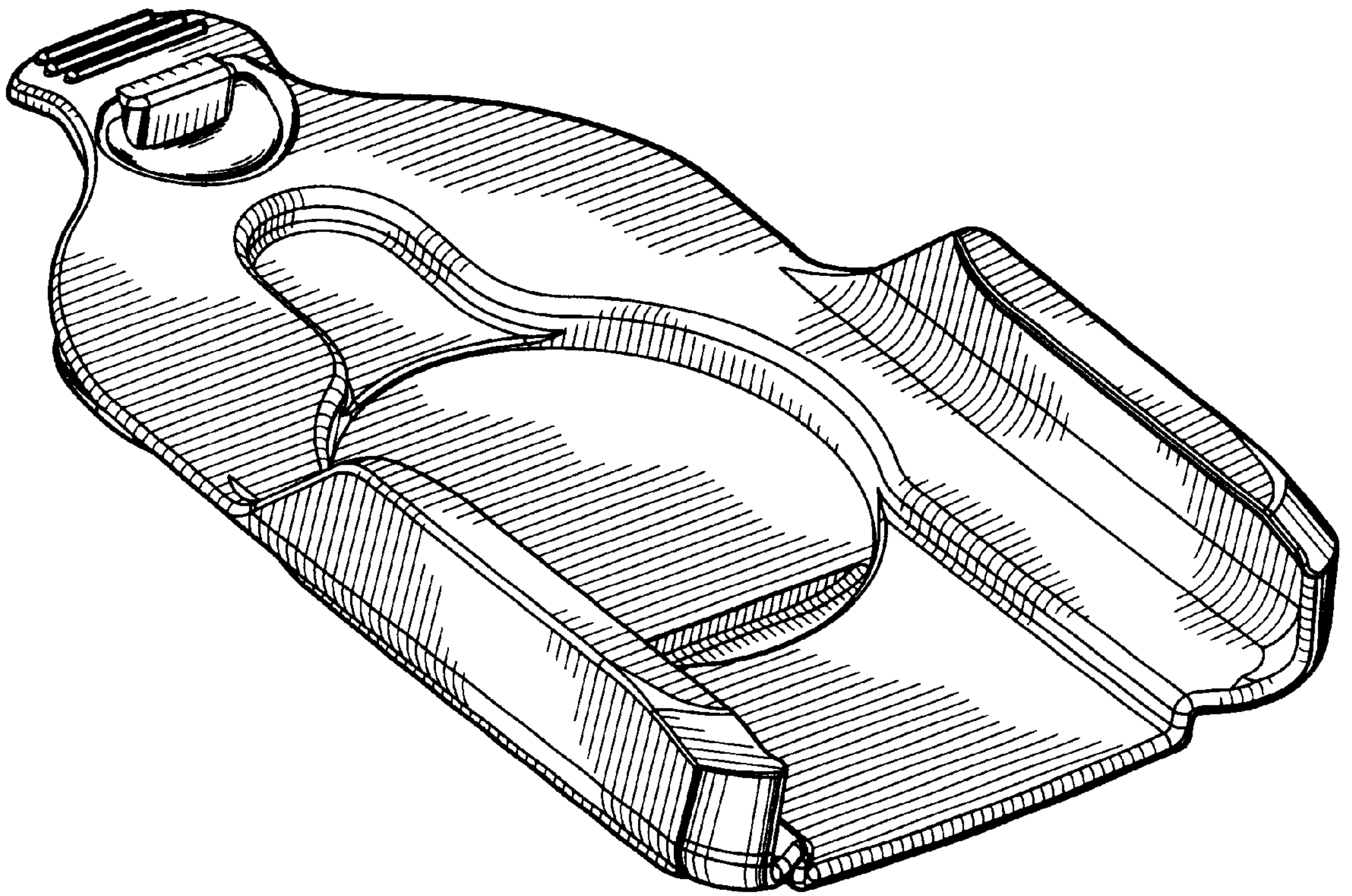

FIG. 8

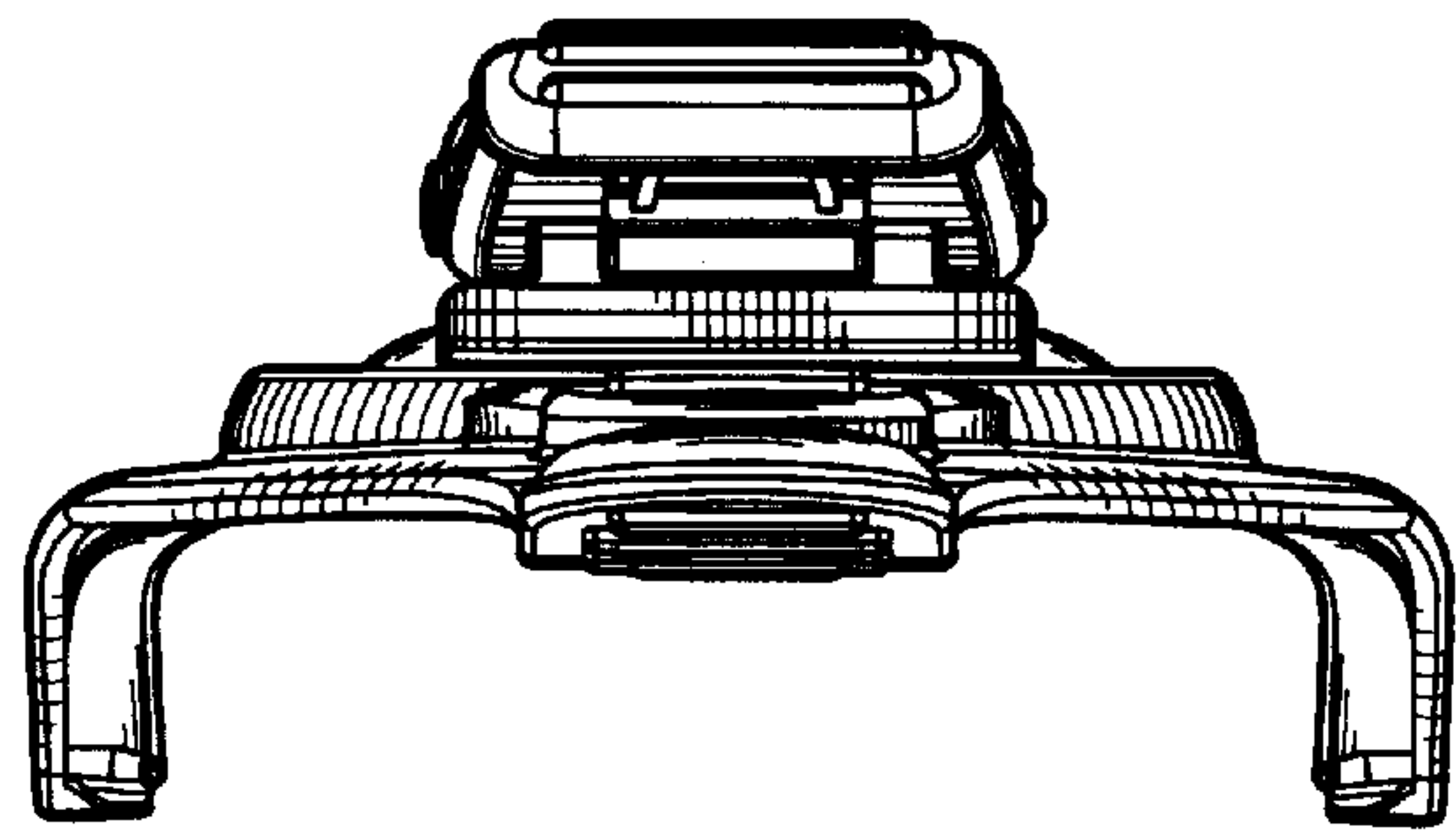

FIG. 9

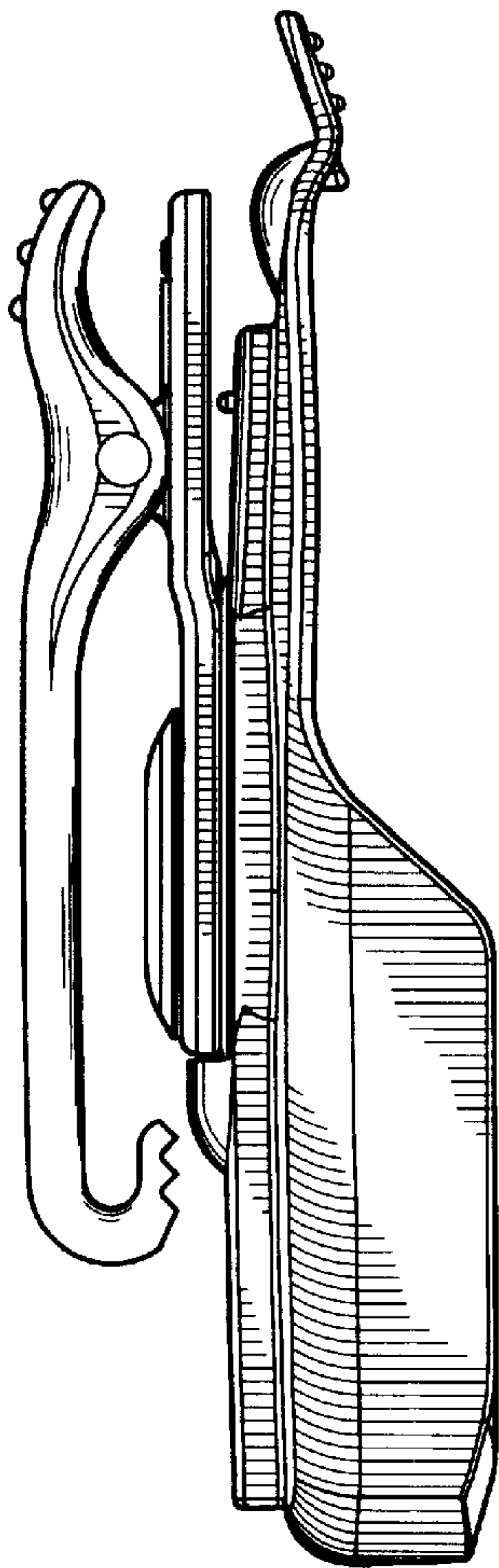

FIG. 10

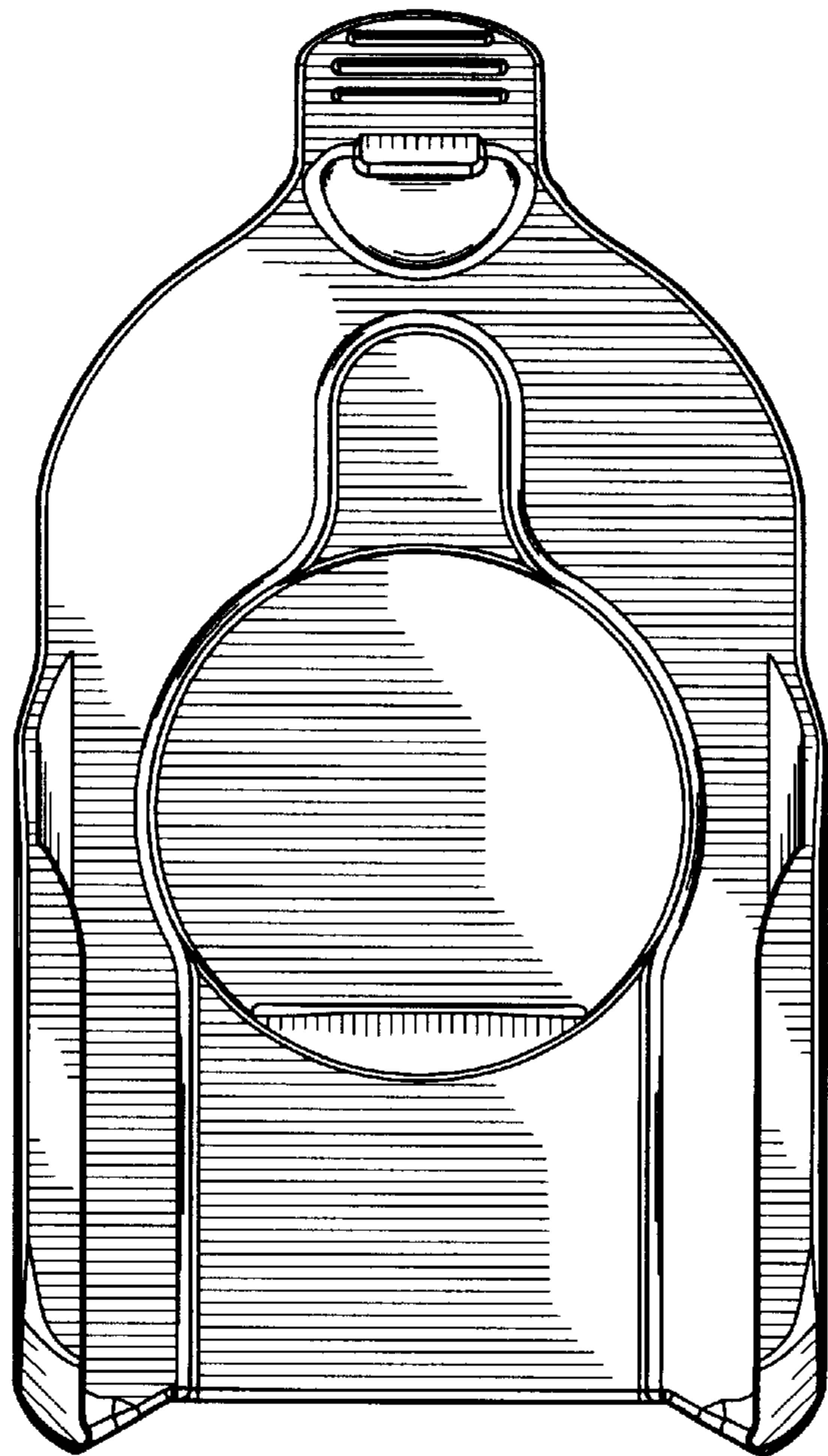

FIG. 11

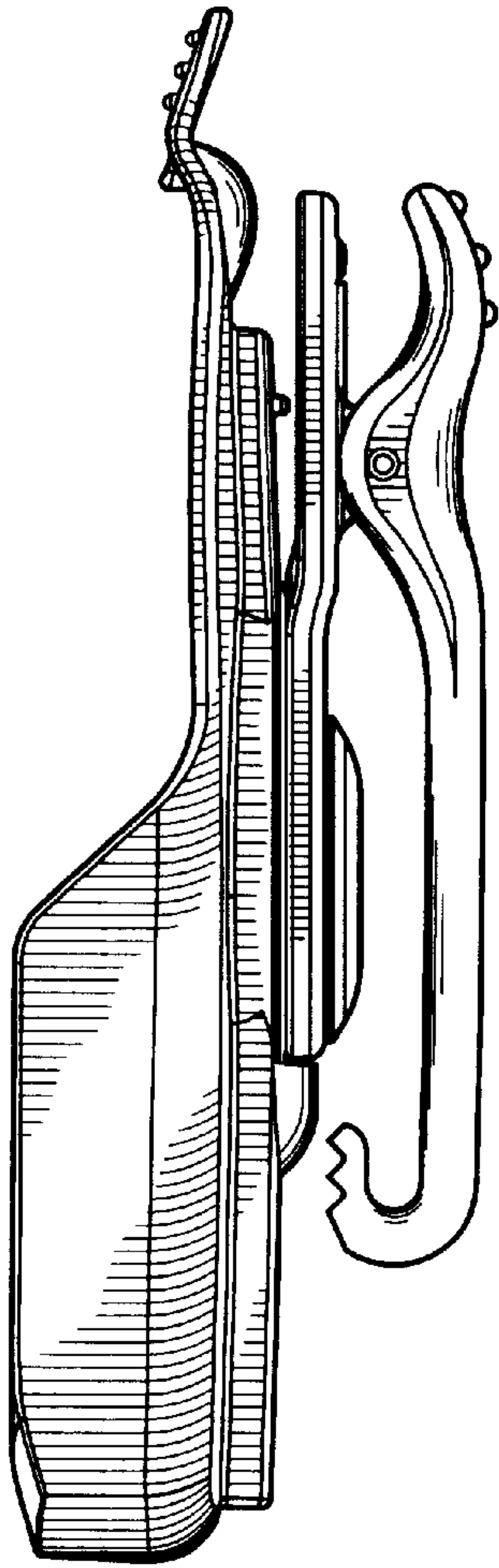

FIG. 12

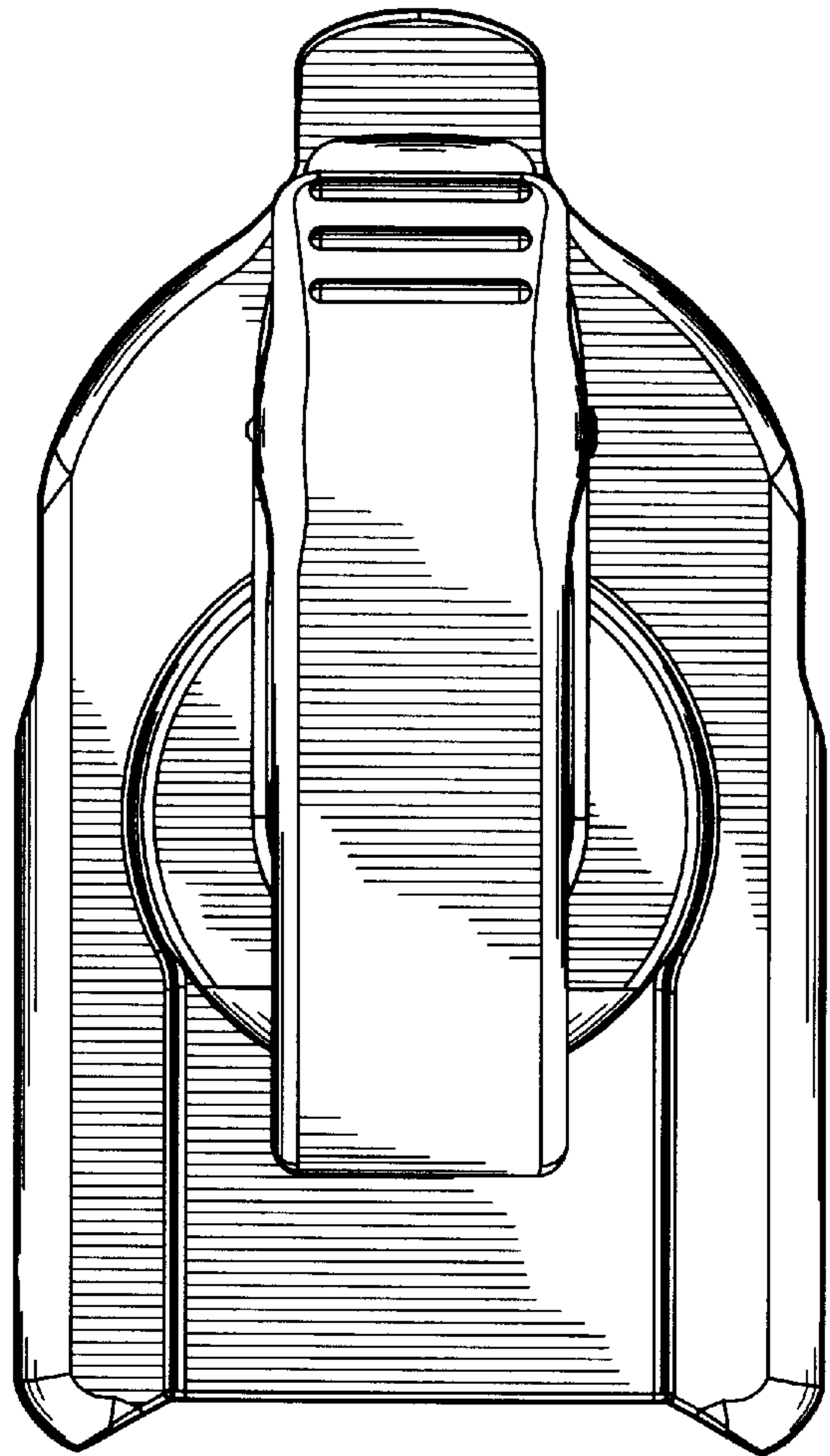

FIG. 13

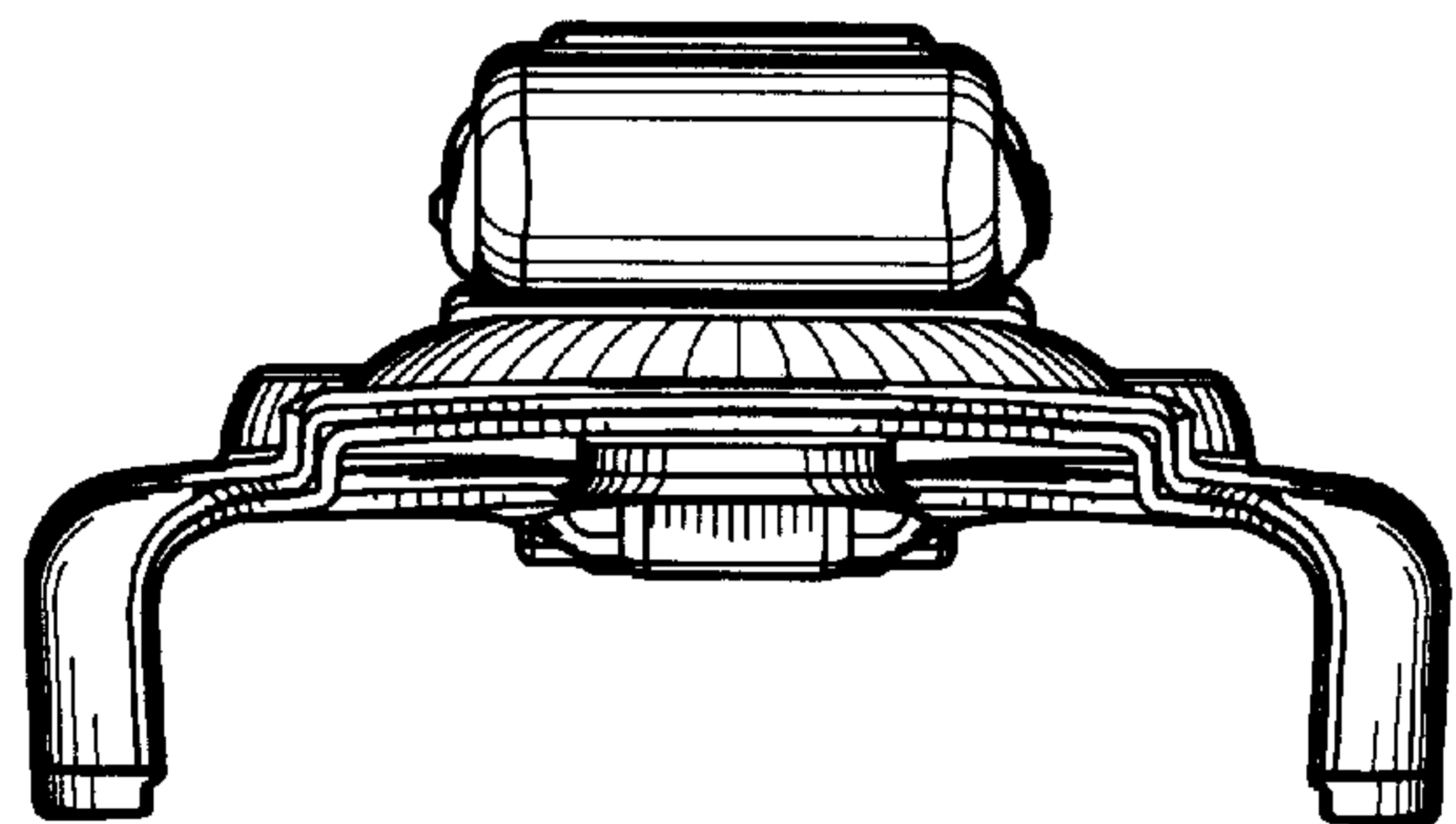

FIG. 14