



US00D419257S

United States Patent [19]

[11] **Patent Number: Des. 419,257**

Hsu

[45] **Date of Patent: ** Jan. 18, 2000**

[54] **GARDEN LAMP**

4,996,636 2/1991 Lovett 362/431

[76] Inventor: **Hui-Piao Hsu**, 8th Fl., No. 161, Sec. 5,
Ming-Sheng Rd., Taipei, Taiwan

Primary Examiner—Susan J. Lucas
Attorney, Agent, or Firm—Bacon & Thomas

[**] Term: **14 Years**

[57] **CLAIM**

[21] Appl. No.: **29/096,322**

The ornamental design for garden lamp, as shown and described.

[22] Filed: **Nov. 10, 1998**

DESCRIPTION

[51] **LOC (7) Cl.** **26-05**

[52] **U.S. Cl.** **D26/67**

[58] **Field of Search** D26/67-71, 63;
362/431, 147, 153, 153.1, 338, 249, 414,
336

FIG. 1 is a top, front right side perspective view thereof;
FIG. 2 is a front elevational view thereof;
FIG. 3 is a rear elevational view thereof;
FIG. 4 is a left elevational view thereof;
FIG. 5 is a right elevational view thereof;
FIG. 6 is a top plan view thereof; and,
FIG. 7 is a bottom plan view thereof.

[56] **References Cited**

U.S. PATENT DOCUMENTS

4,774,648 9/1988 Kakuk et al. 362/431 X

1 Claim, 4 Drawing Sheets

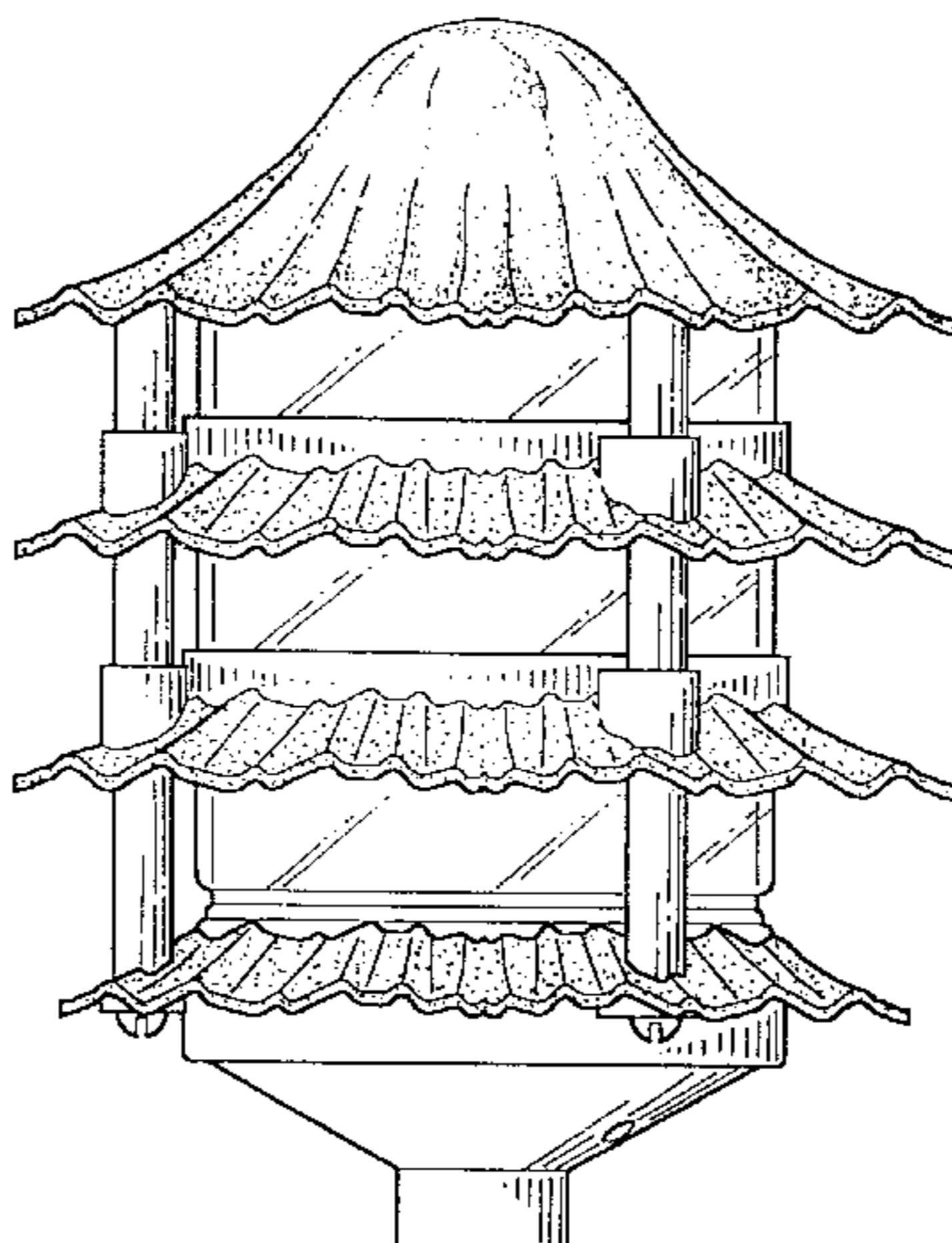
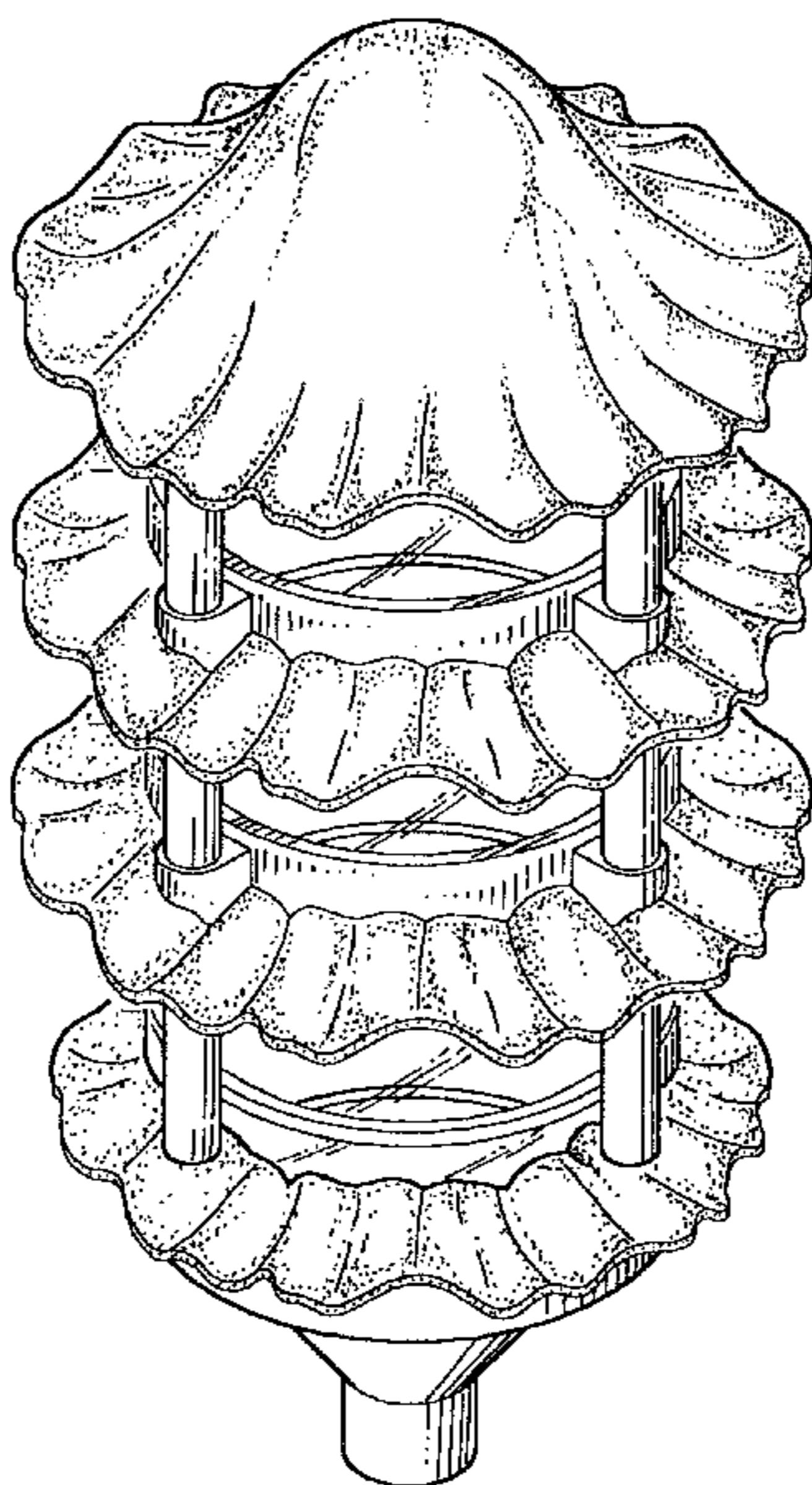

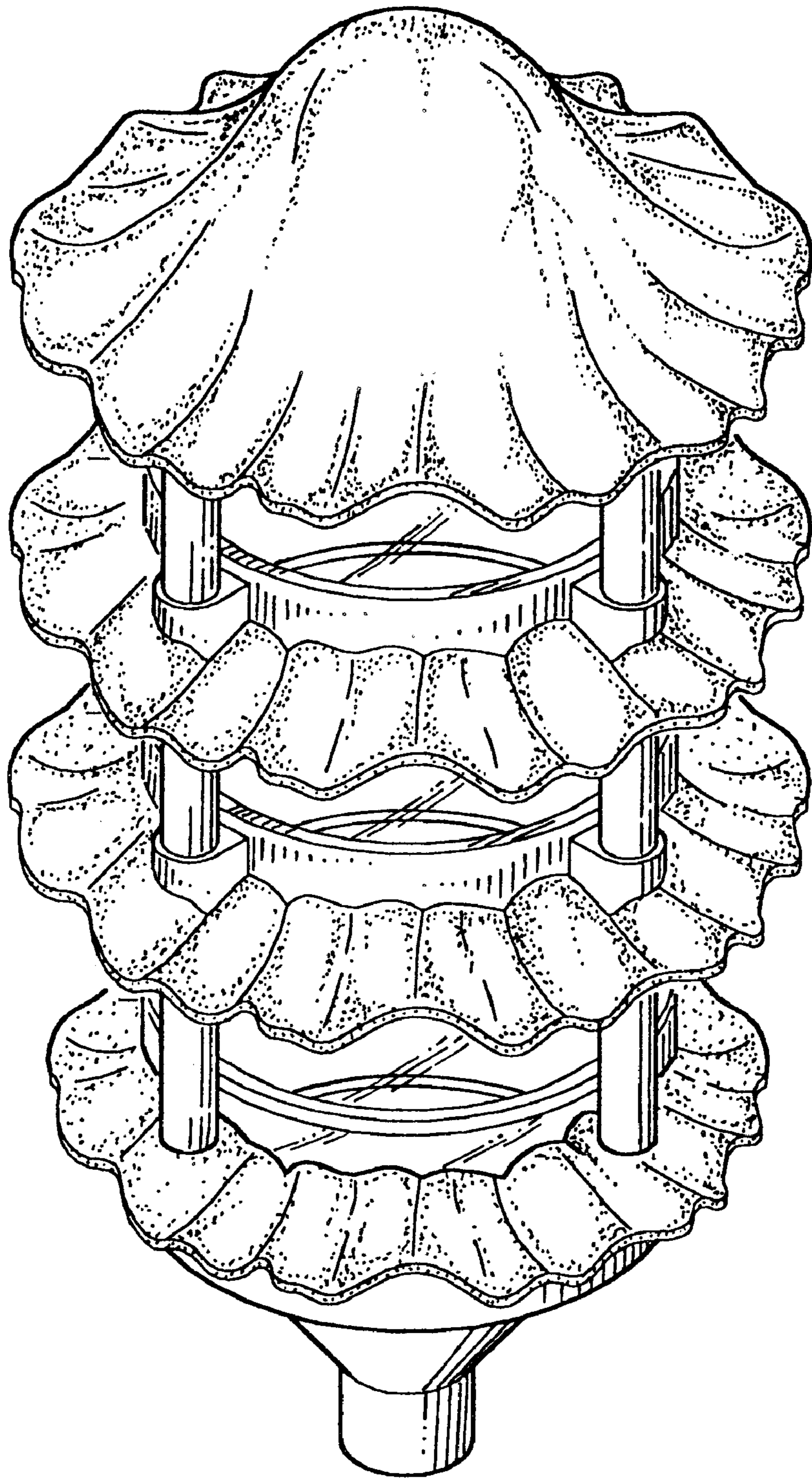

Fig. 1

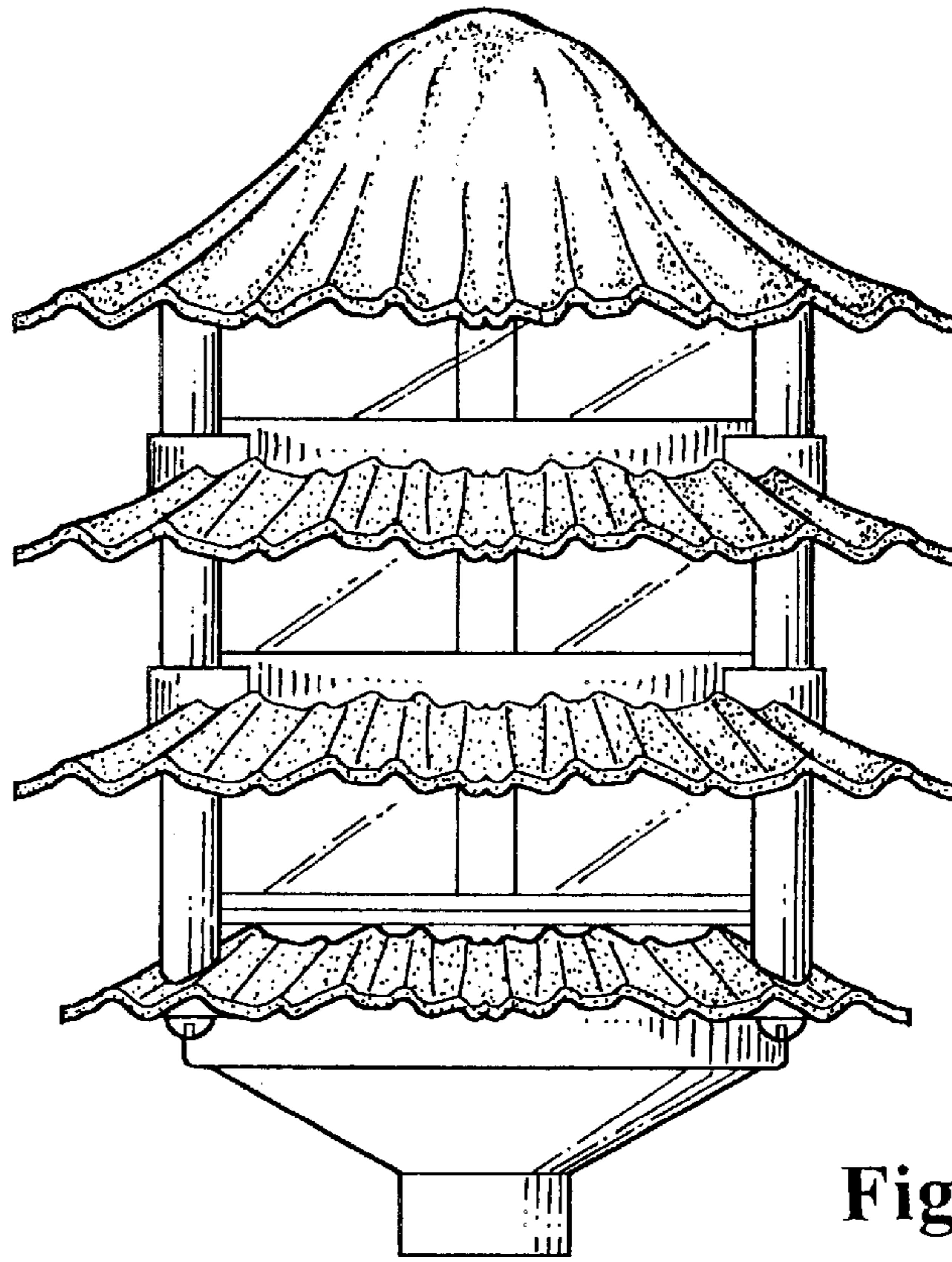

Fig. 2

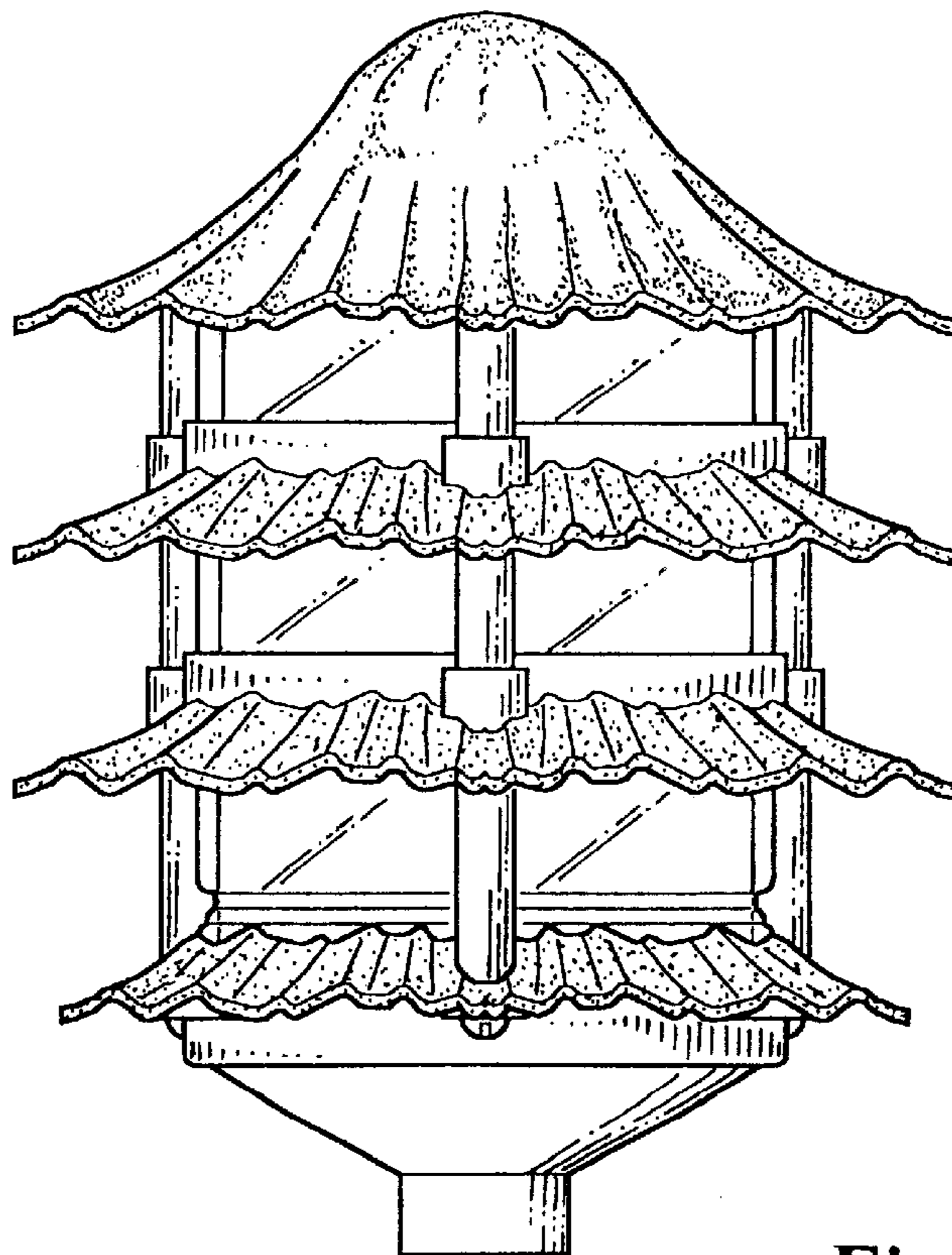

Fig. 3

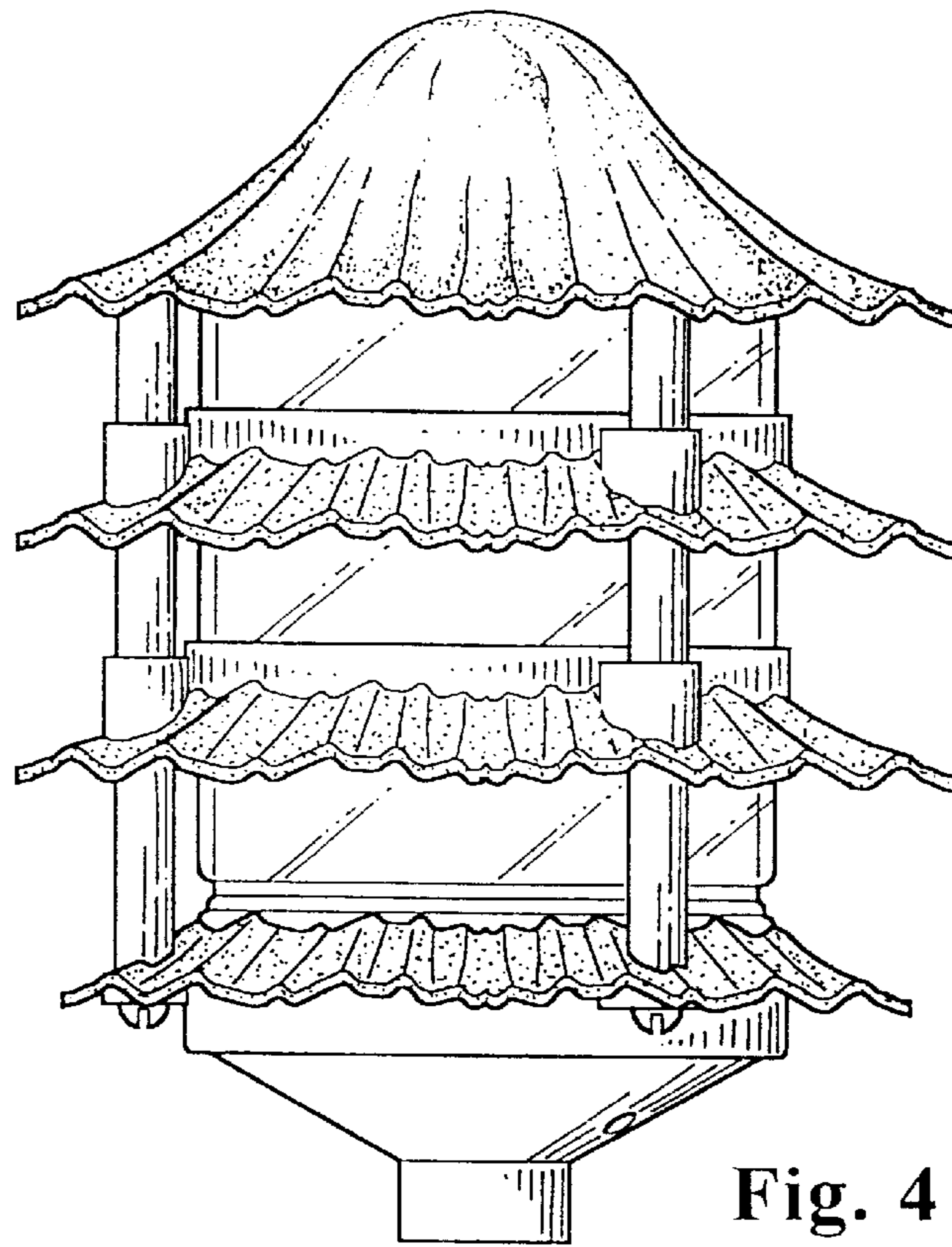

Fig. 4

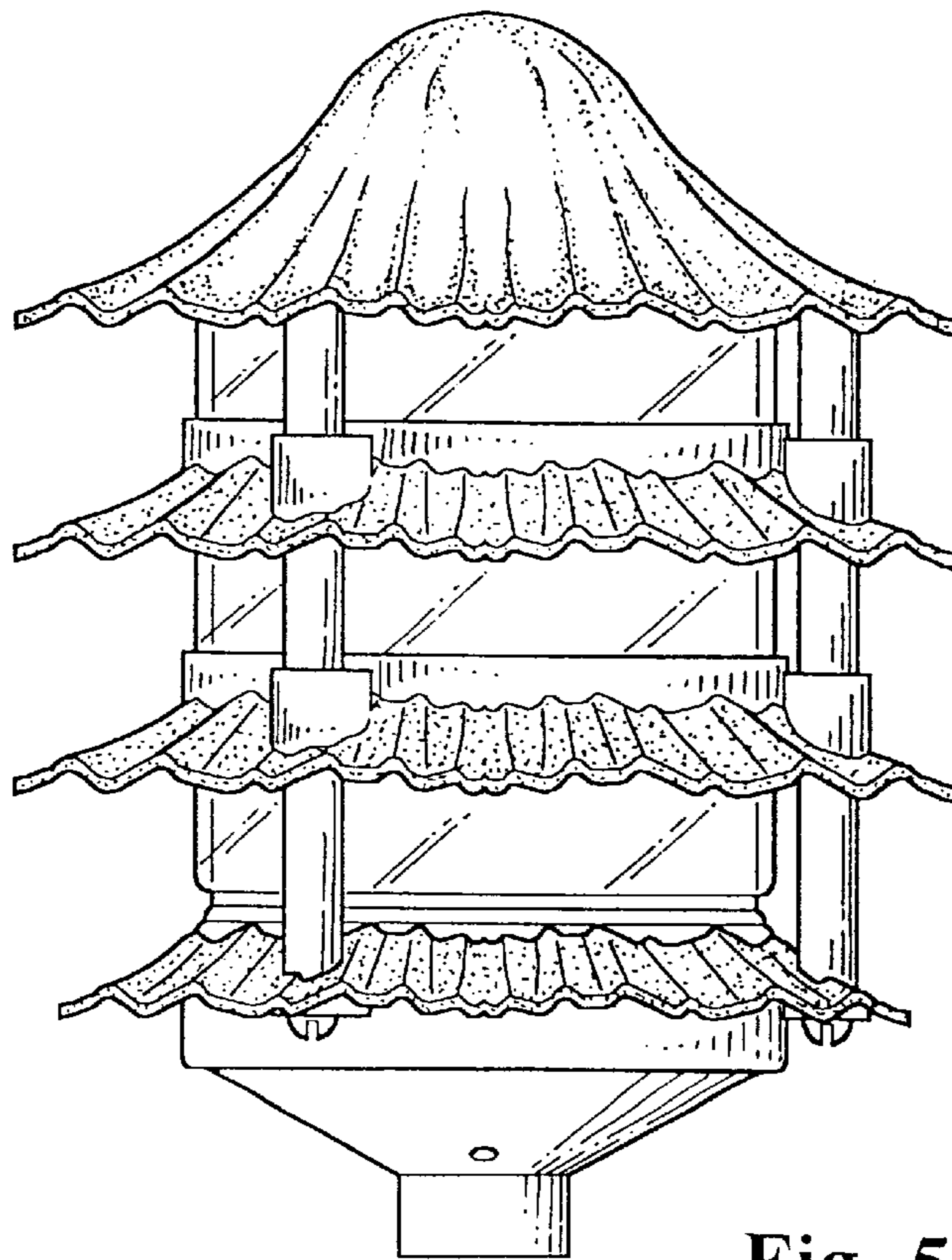

Fig. 5

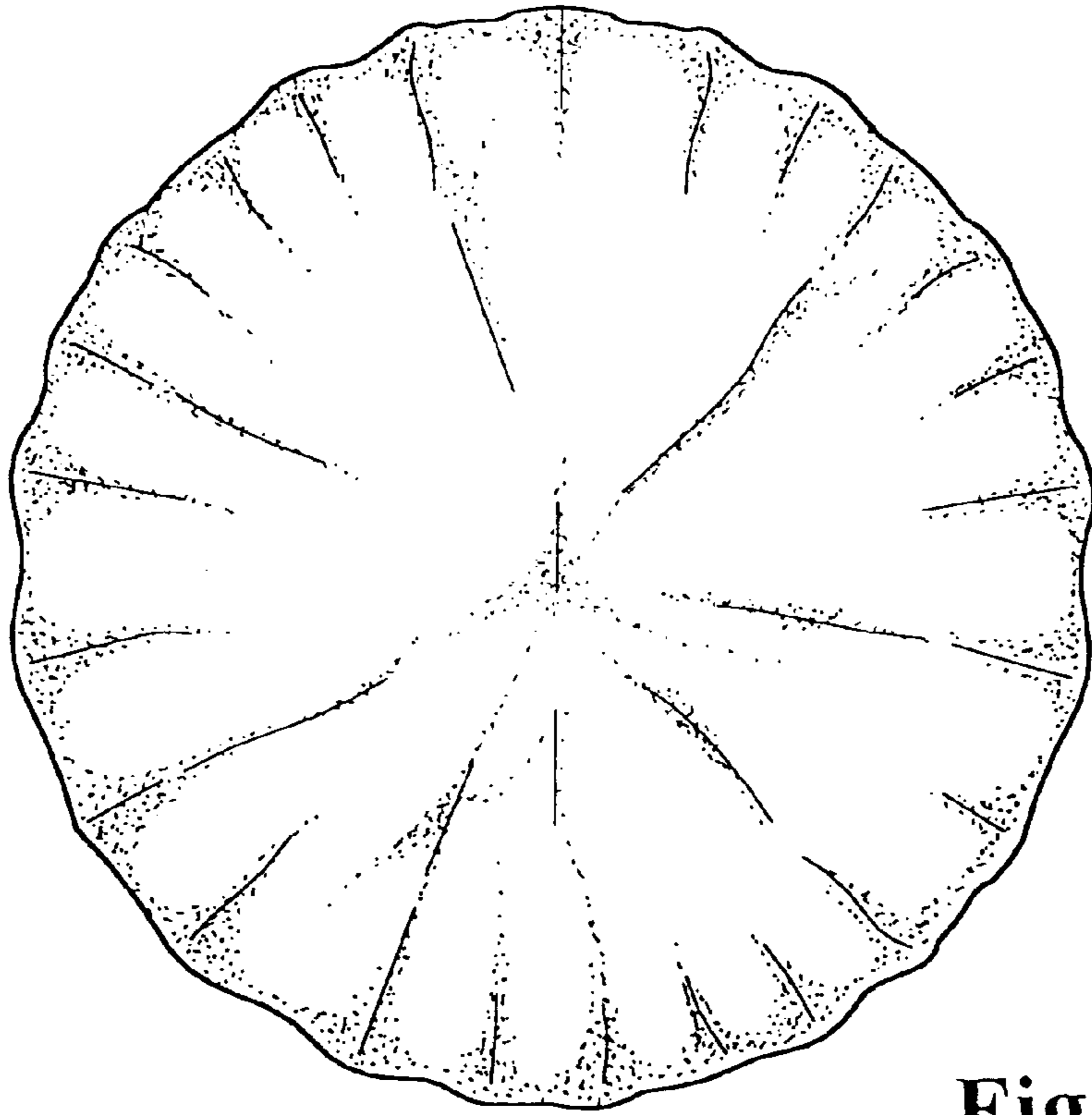

Fig. 6

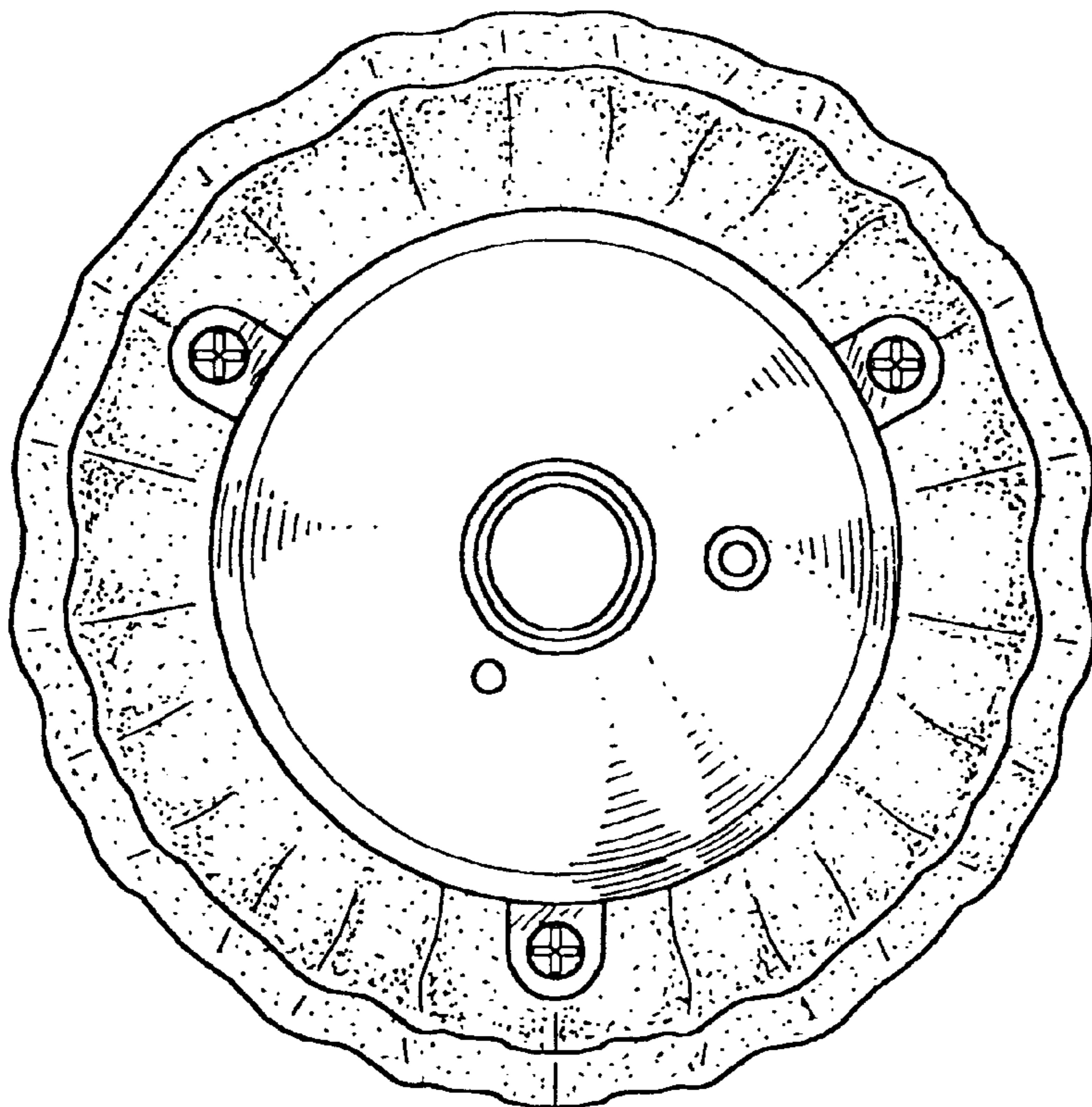

Fig. 7