



US00D419225S

**United States Patent** [19]  
**Johansson**

[11] **Patent Number: Des. 419,225**  
[45] **Date of Patent: \*\* Jan. 18, 2000**

[54] **SHOWER AND BATH TUB**

4,809,368 3/1989 Johansson ..... 4/540  
5,393,119 2/1995 Mukdi ..... 4/540 X

[75] Inventor: **Arne Johansson**, Farstorp, Sweden

*Primary Examiner*—Eric Watterson

[73] Assignee: **A. Johansson Konstruktion AB**, Eslov, Sweden

*Attorney, Agent, or Firm*—Tarolli, Sundheim, Covell  
Tummino & Szabo

[\*\*] Term: **14 Years**

[57] **CLAIM**

[21] Appl. No.: **29/090,754**

The ornamental design for a shower and bath tub, as shown and described.

[22] Filed: **Jul. 15, 1998**

**DESCRIPTION**

[30] **Foreign Application Priority Data**

Jan. 26, 1998 [SE] Sweden ..... 98-0148

FIG. 1 is a perspective view of the shower and bath tub;  
FIG. 2 is a side elevational view of the shower and bath tub,  
the opposite side being a mirror image.

[51] **LOC (7) Cl.** ..... **23-02**

[52] **U.S. Cl.** ..... **D23/280.2**

FIG. 3 is a top plan view of the shower and bath tub;  
FIG. 4 is a bottom plan view of the shower and bath tub;  
FIG. 5 is a front elevational view of the shower and bath tub;  
FIG. 6 is a rear elevational view of the shower and bath tub;  
FIG. 7 is a perspective view of the shower and bath tub in  
horizontal position; and,

[58] **Field of Search** ..... D23/277-293.1,  
D23/303-313; 4/538, 540, 556, 580, 585,  
562.1; D12/131

FIG. 8 is a side elevational view, the opposite side being a  
mirror image thereof, the bottom hose shown broken away  
to show an indeterminate length.

[56] **References Cited**

**U.S. PATENT DOCUMENTS**

D. 273,700 5/1984 Parker ..... D23/280.4  
D. 350,817 9/1994 Rothburn ..... D23/277

**1 Claim, 8 Drawing Sheets**

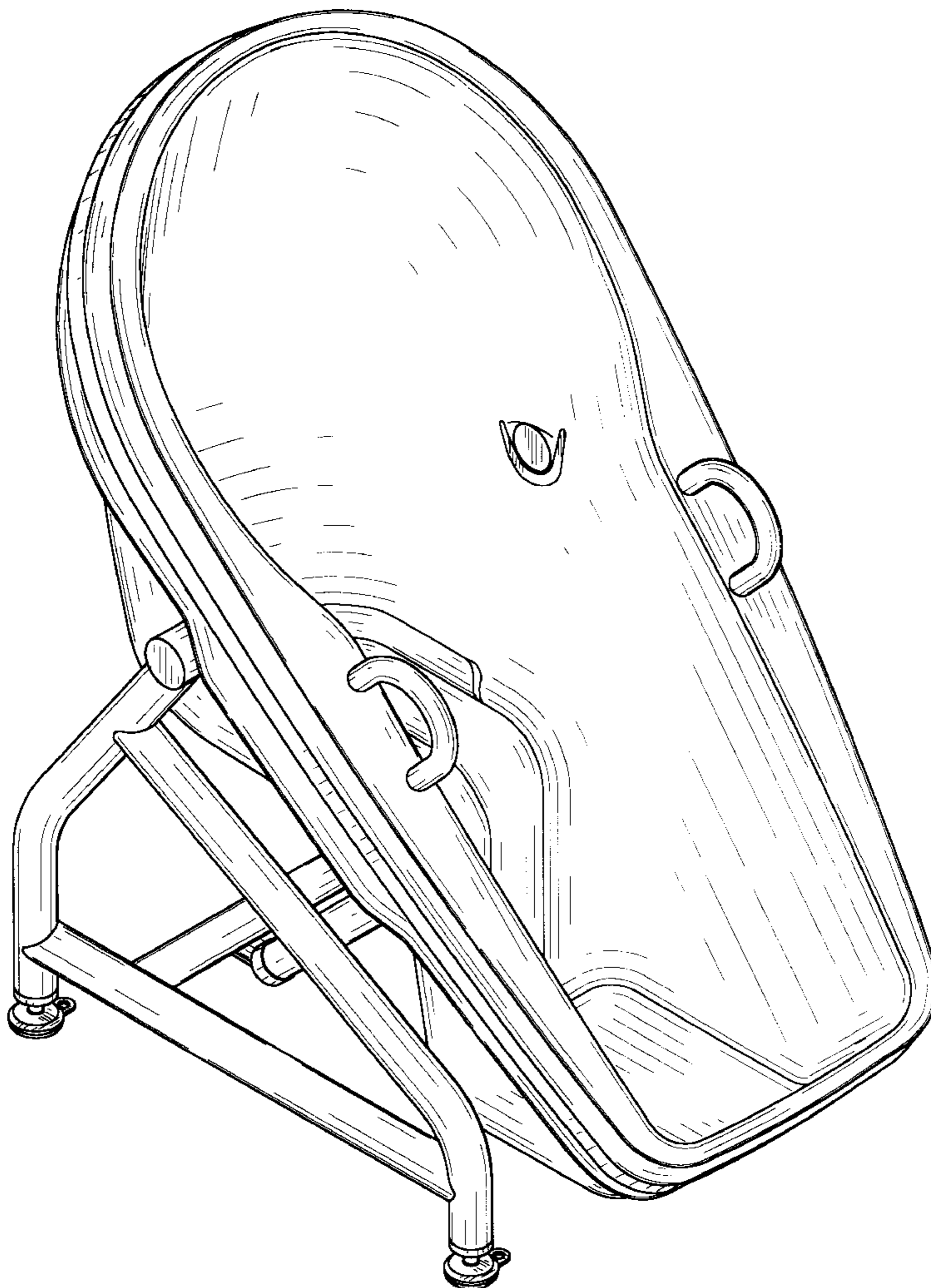

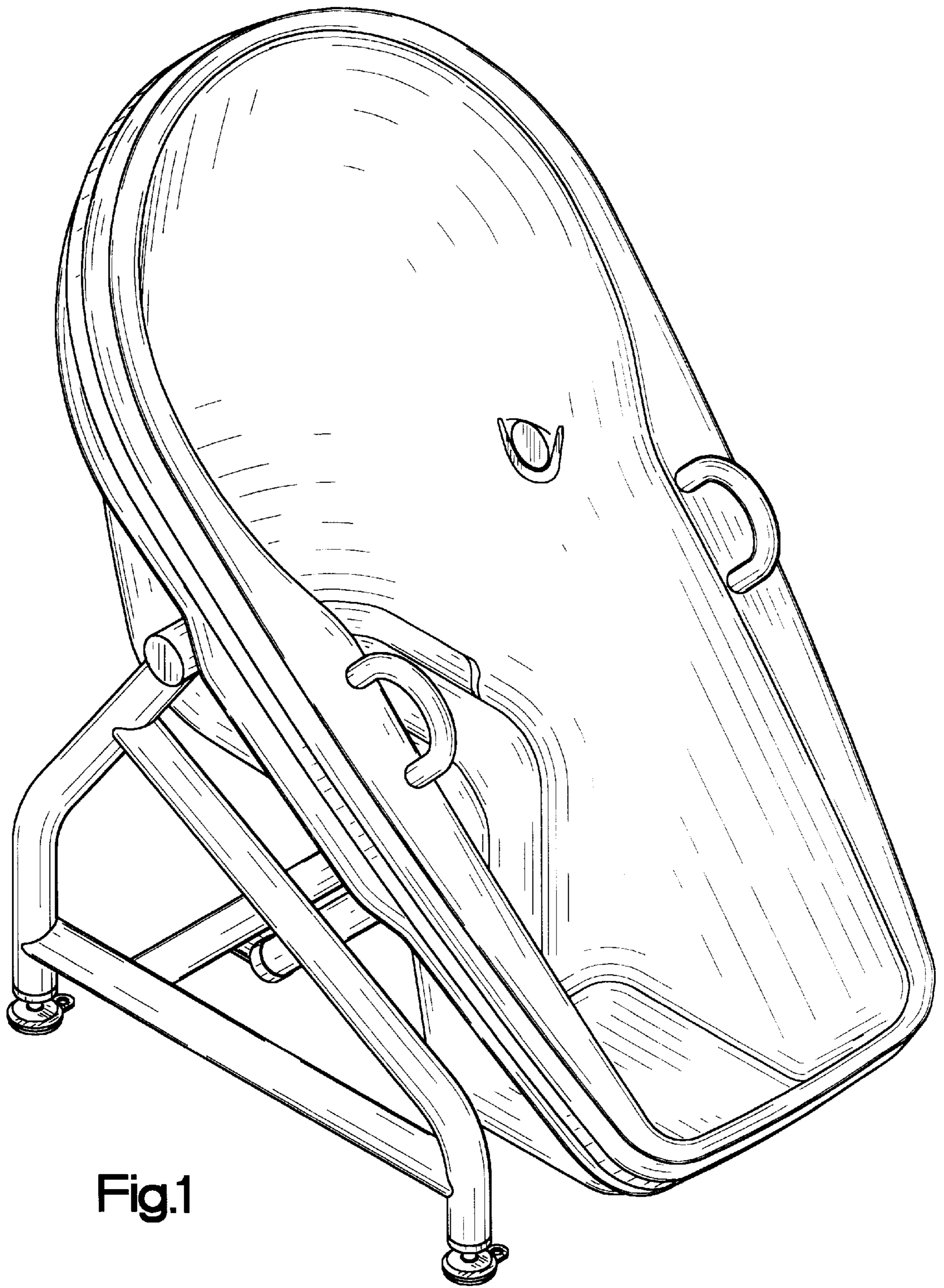
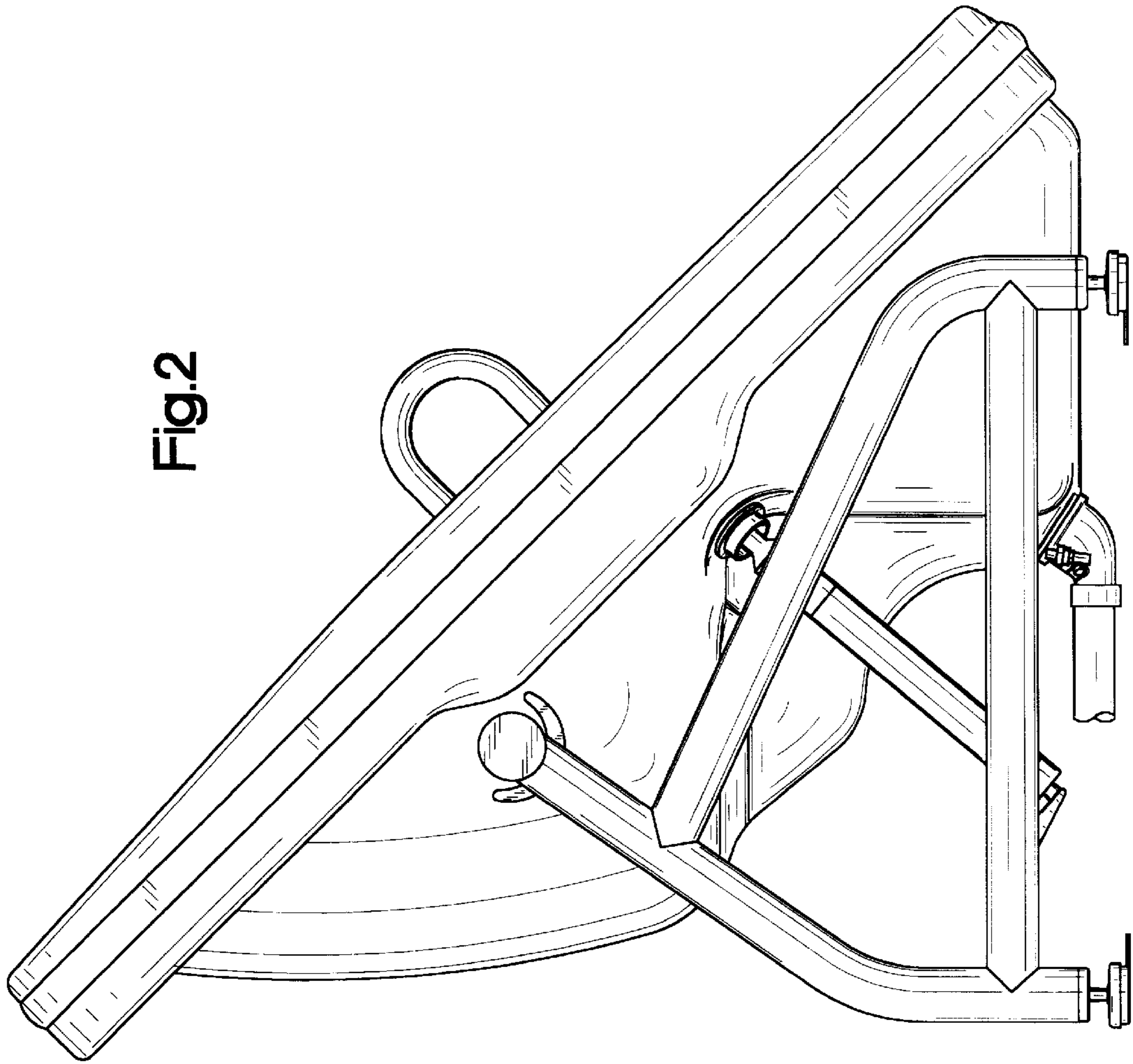

Fig.1

Fig.2



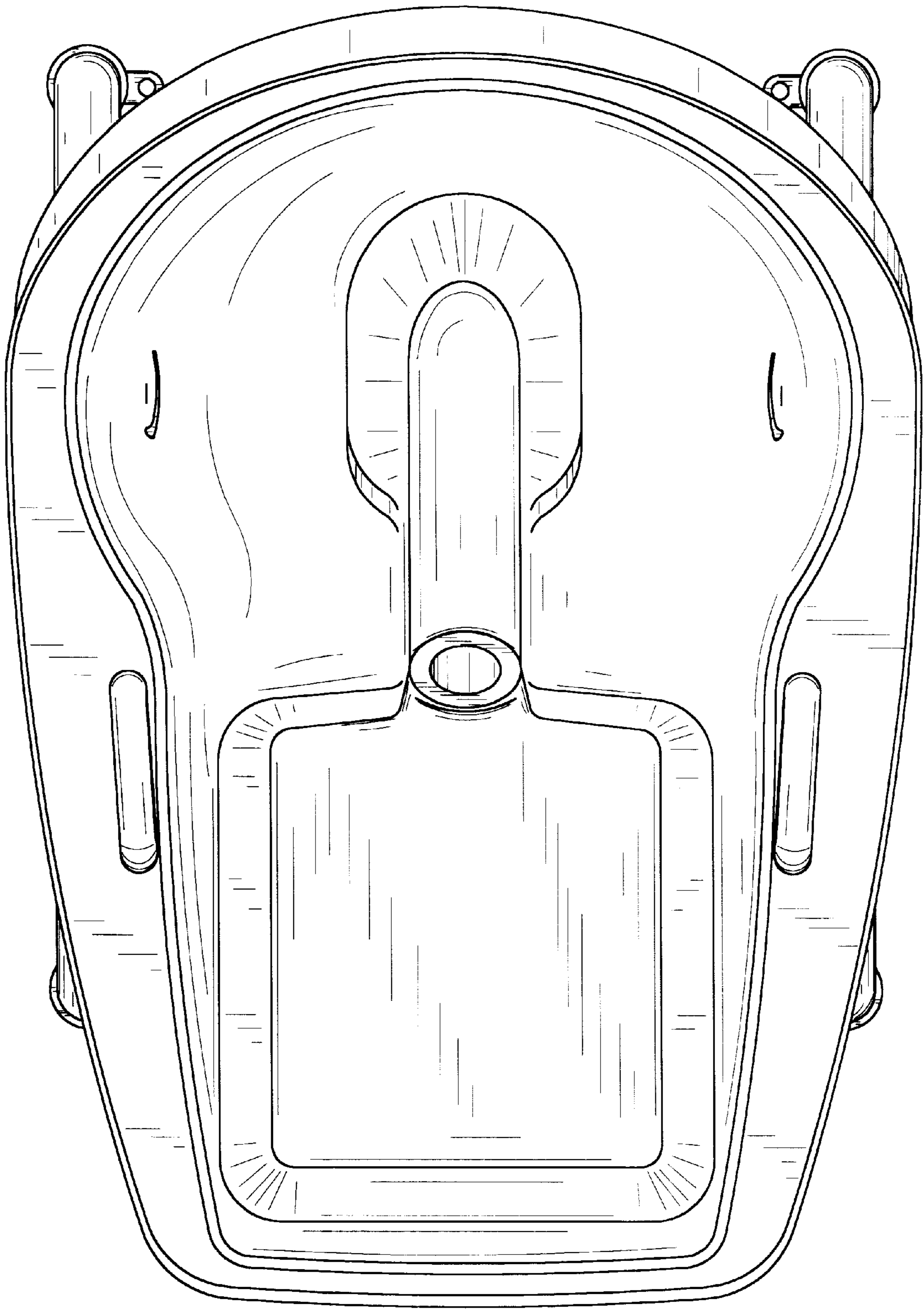

Fig.3

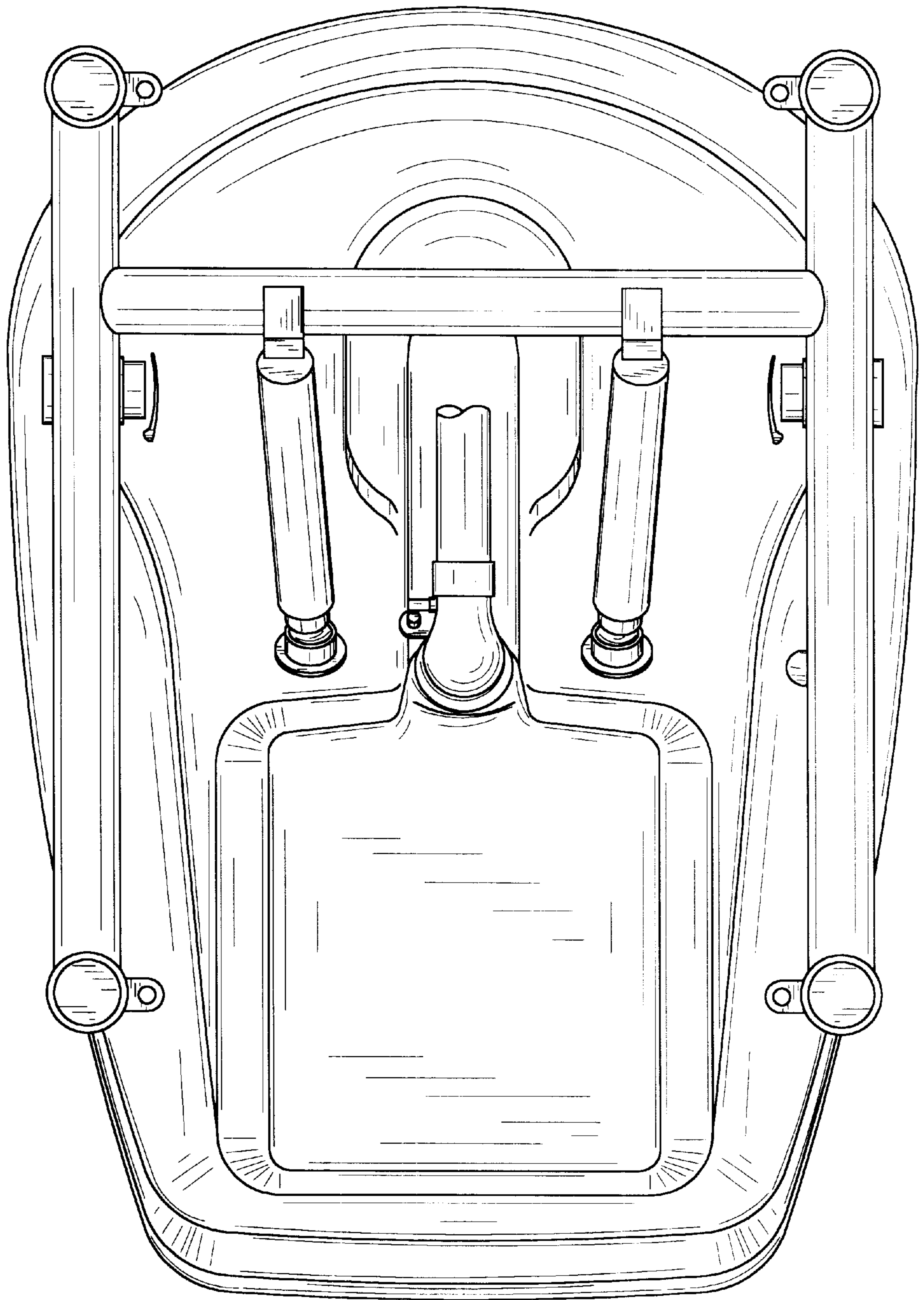

Fig.4

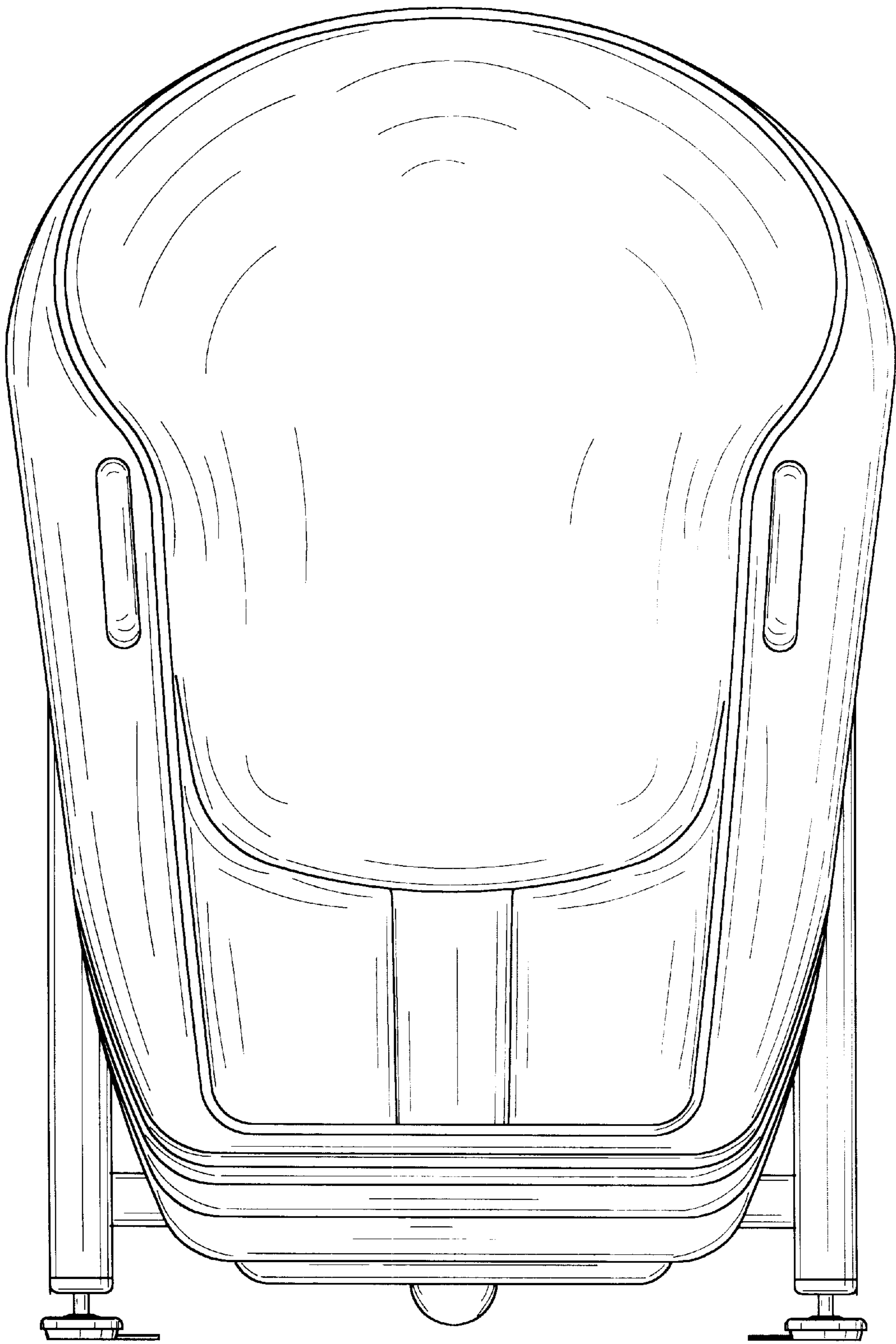

Fig.5

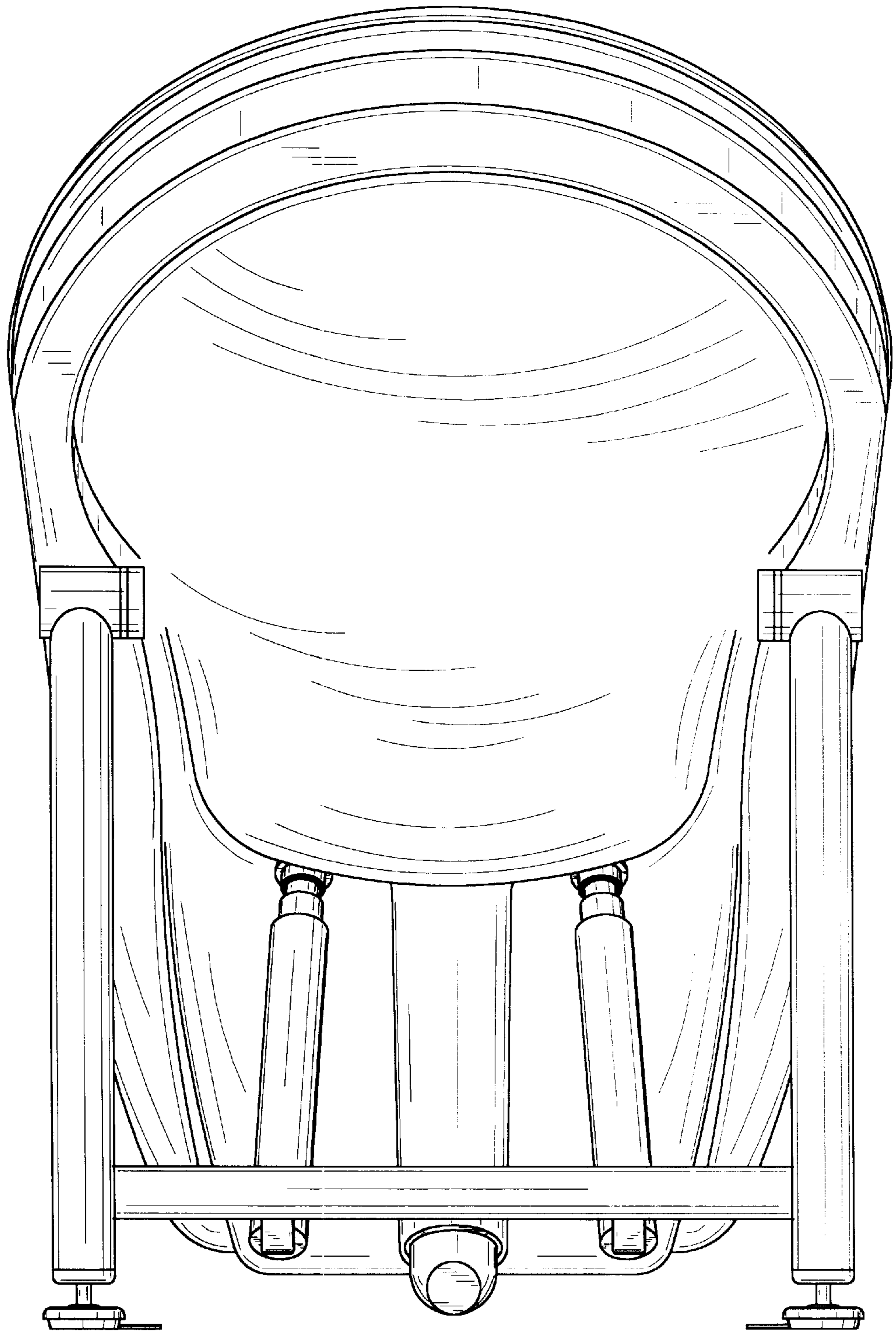

Fig.6

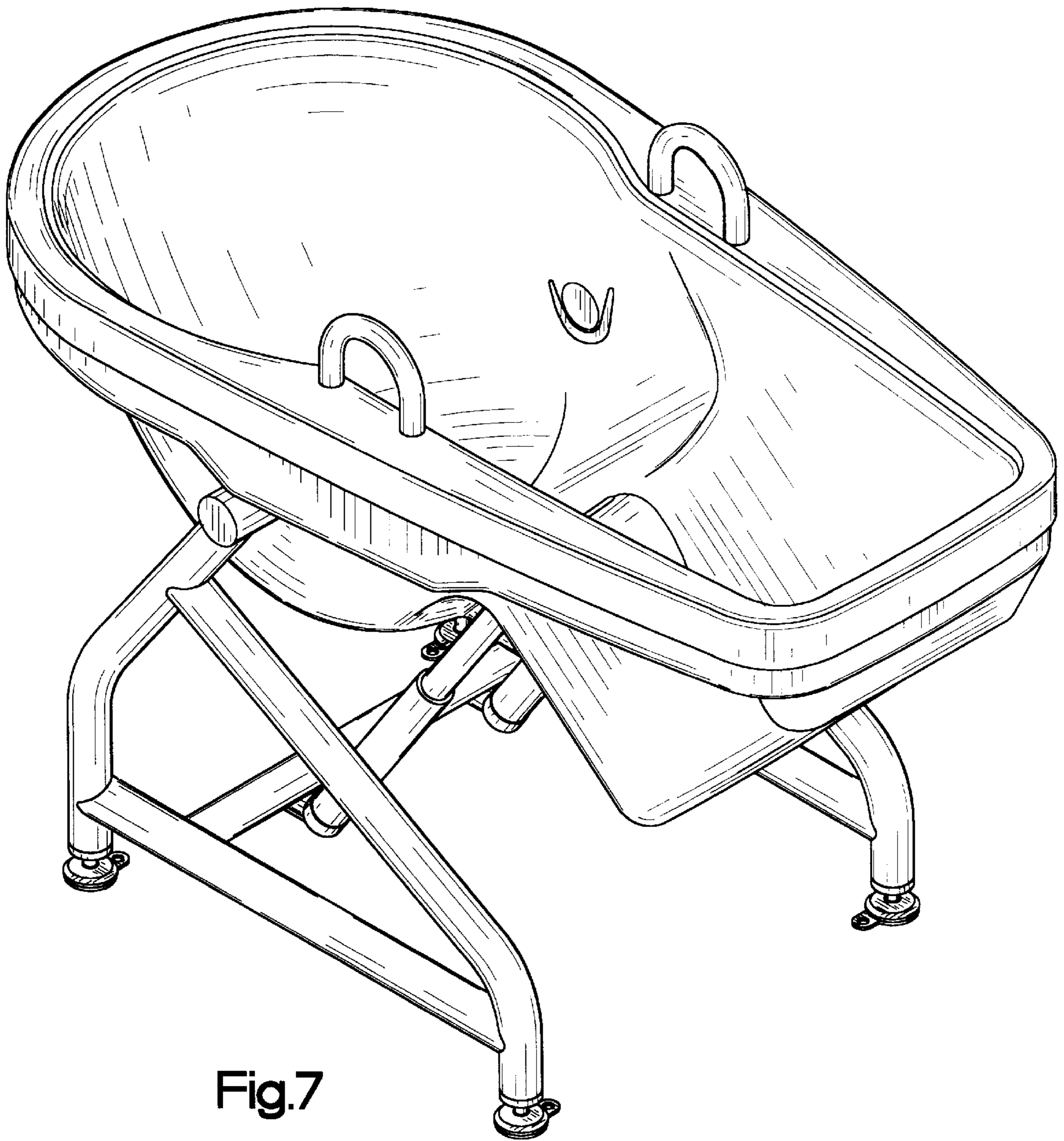

Fig.7



Fig.8

