



US00D419199S

United States Patent [19]
Cordell et al.

[11] **Patent Number: Des. 419,199**
[45] **Date of Patent: ** Jan. 18, 2000**

[54] **GAME MACHINE AND CONSOLE STACK**

[75] Inventors: **John Cordell**, Redmond, Wash.;
Kenichiro Ashida, Kyoto, Japan

[73] Assignee: **Nintendo of America Inc.**, Redmond,
Wash.

[**] Term: **14 Years**

[21] Appl. No.: **29/103,368**

[22] Filed: **Apr. 14, 1999**

[51] **LOC (7) Cl.** **21-01**

[52] **U.S. Cl.** **D21/332**

[58] **Field of Search** D21/324, 328,
D21/332, 333; D14/117.1, 117.7, 117.9,
114, 124; 273/148 B; 463/1, 29.35, 40.47

[56] **References Cited**

U.S. PATENT DOCUMENTS

D. 362,869	10/1995	Oikawa	D21/332
D. 379,832	6/1997	Ashida	D21/332
D. 383,800	9/1997	Ishizaki et al.	D21/332
D. 393,013	3/1998	Ashida	D21/332
D. 393,884	4/1998	Hayami	D21/332
D. 402,328	12/1998	Ashida	D21/332

D. 407,084	3/1999	Waler et al.	D21/332
D. 412,940	8/1999	Kato et al.	D21/332
5,184,830	2/1993	Okada et al.	463/29
5,213,327	5/1993	Kitaue	273/148 B
5,643,087	7/1997	Marcus et al.	463/38

Primary Examiner—Prabhakar Deshmukh
Attorney, Agent, or Firm—Nixon & Vanderhye P.C.

[57] **CLAIM**

The ornamental design for a game machine and console stack, as shown and described.

DESCRIPTION

FIG. 1 is a top, front and left perspective view of a game machine and console stack in accordance with the new design;
FIG. 2 is a bottom, rear and right perspective view thereof;
FIG. 3 is a front elevational view thereof;
FIG. 4 is a top plan view thereof;
FIG. 5 is a rear elevational view thereof;
FIG. 6 is a bottom plan view thereof;
FIG. 7 is a right side view thereof; and,
FIG. 8 is a left side view thereof.

The broken lines are for illustrative purpose only and forms no part of the claimed design.

1 Claim, 8 Drawing Sheets

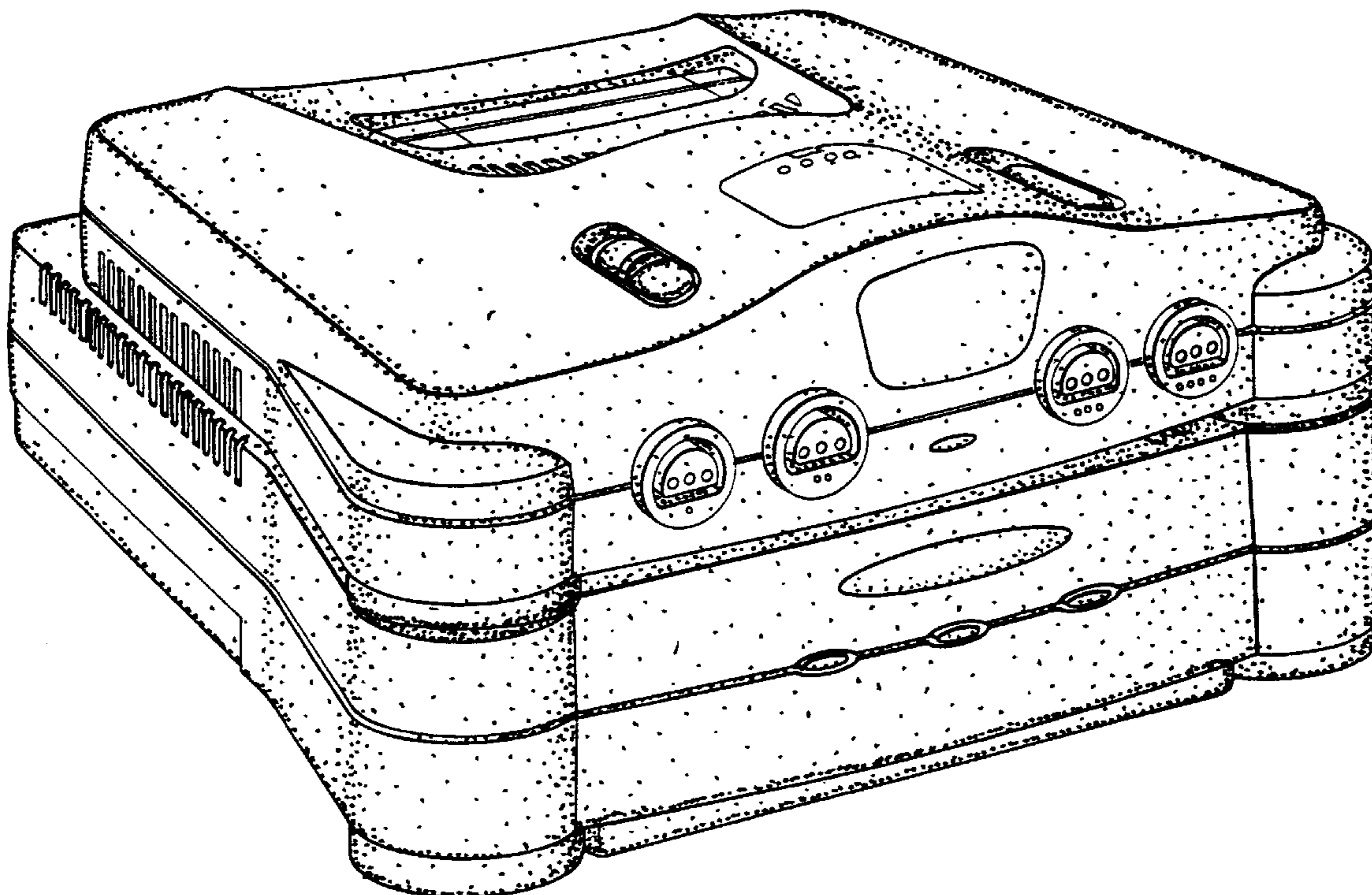
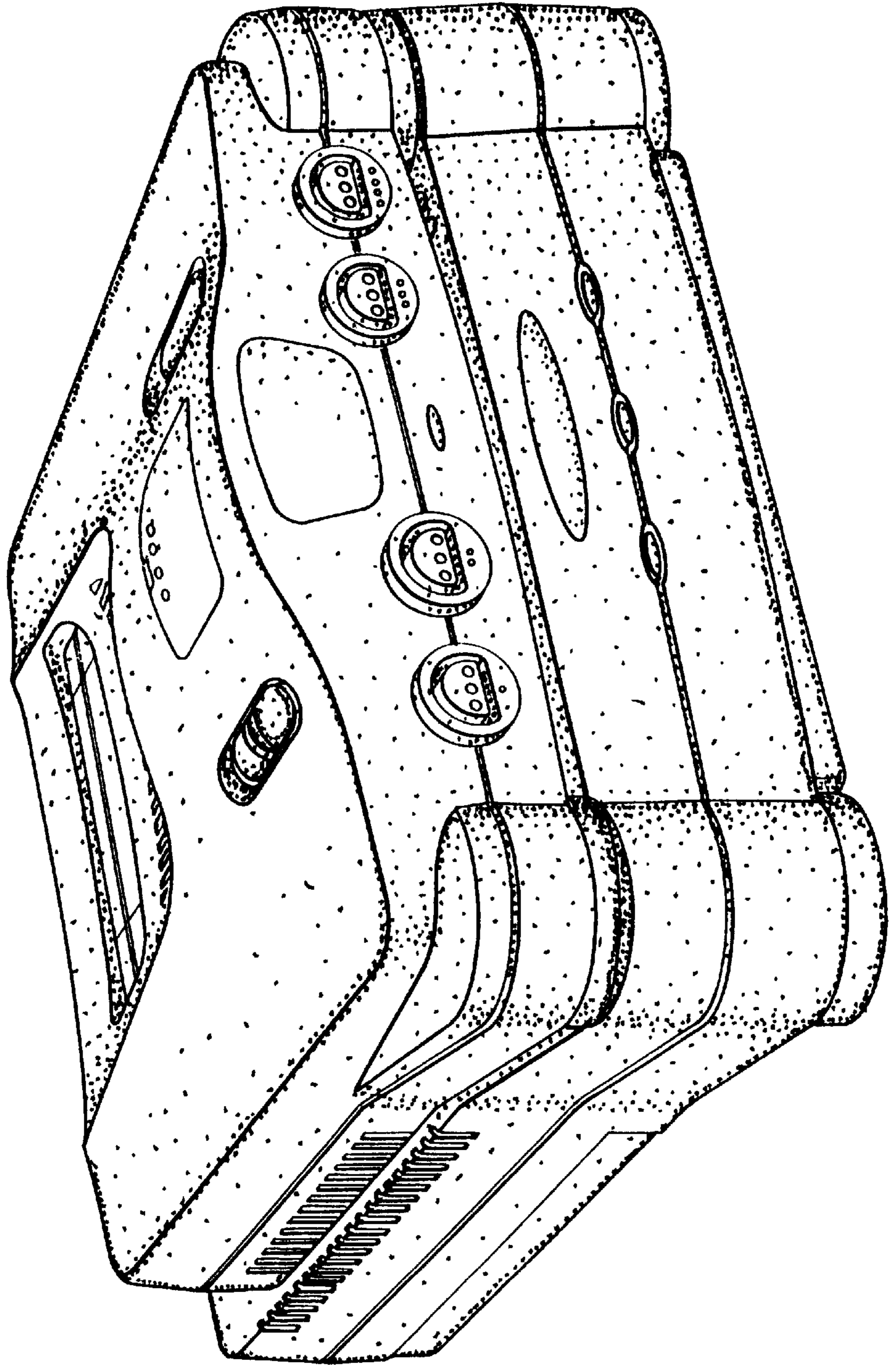

FIG. 1



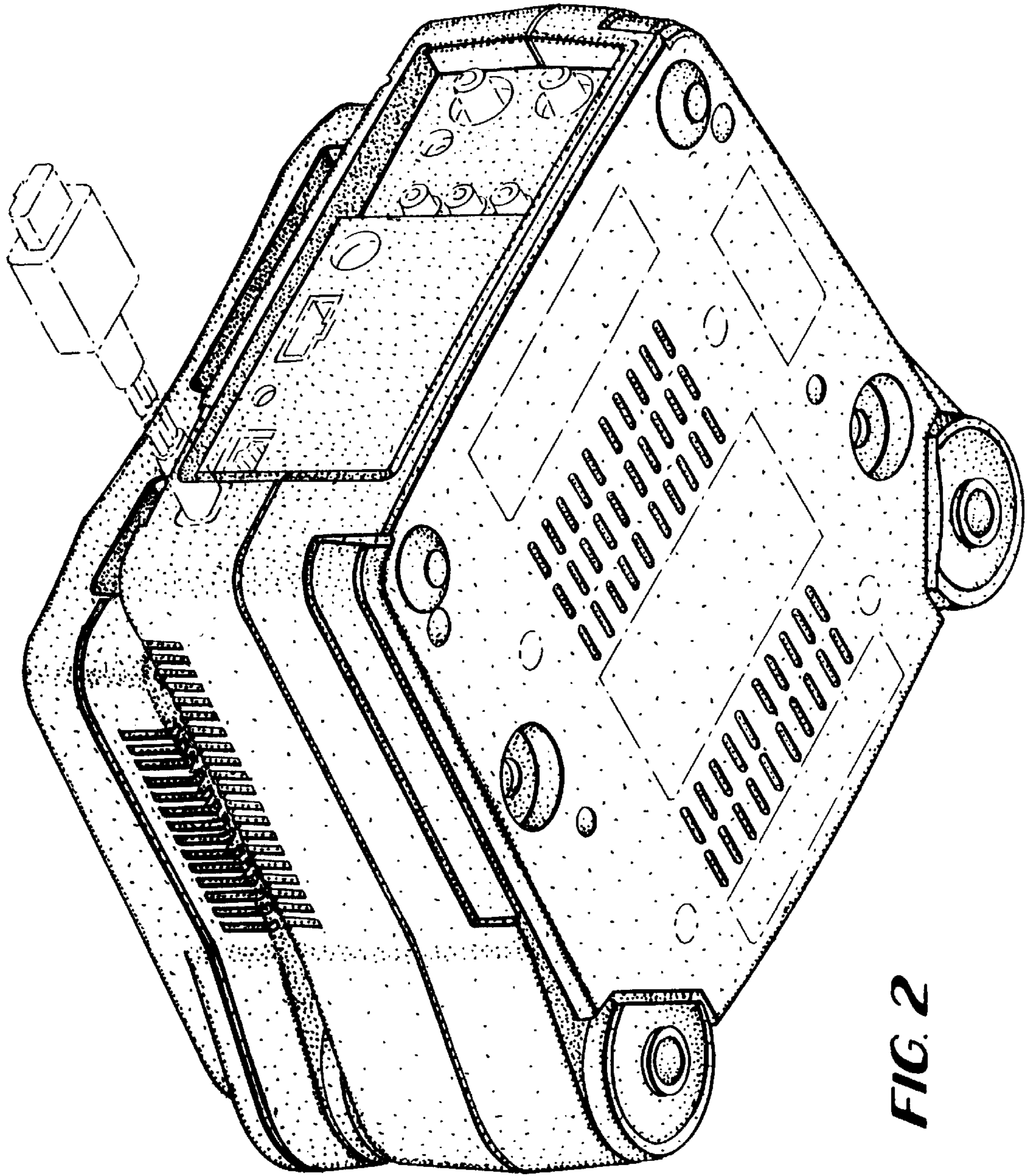

FIG. 2

FIG. 3

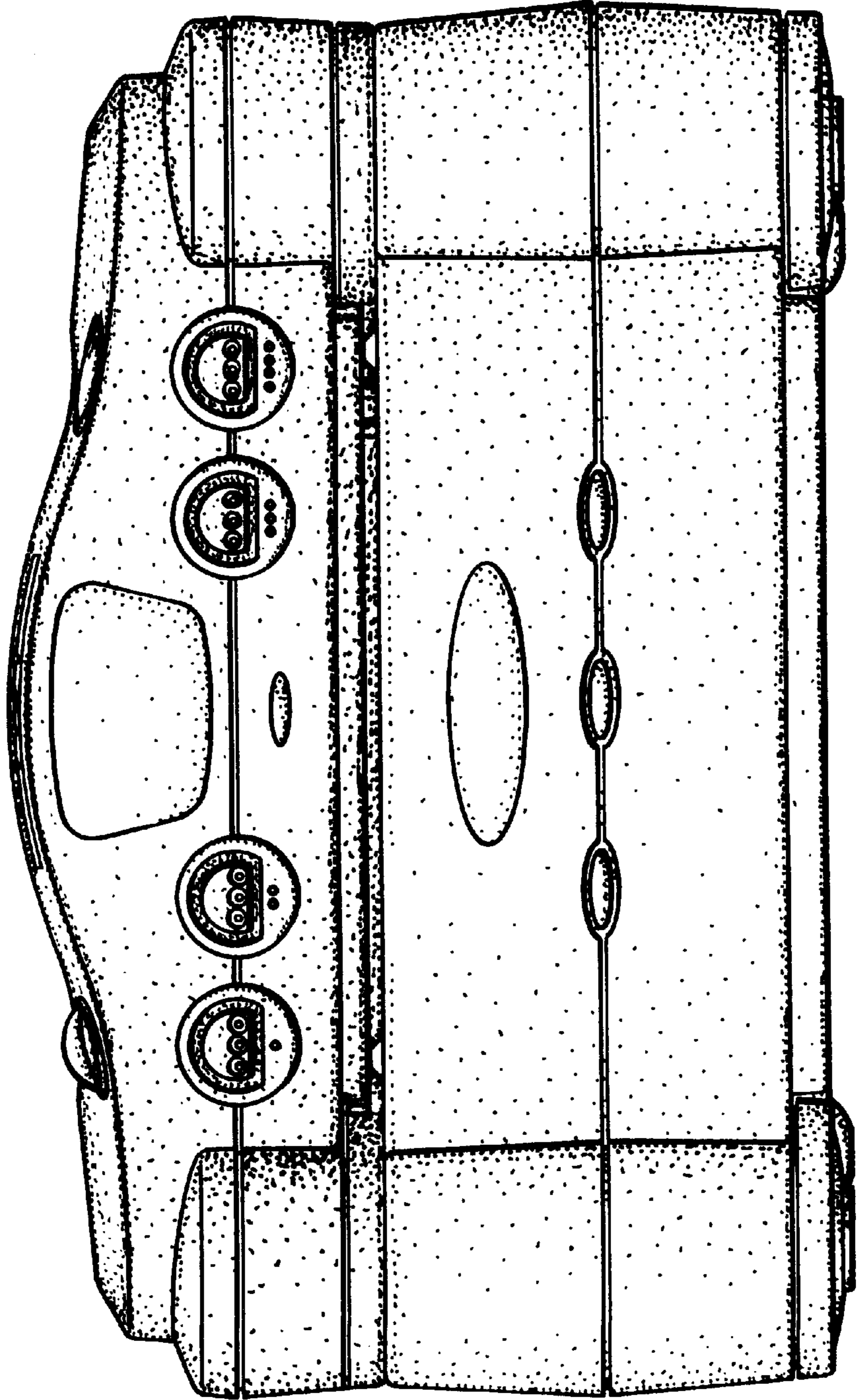

FIG. 4

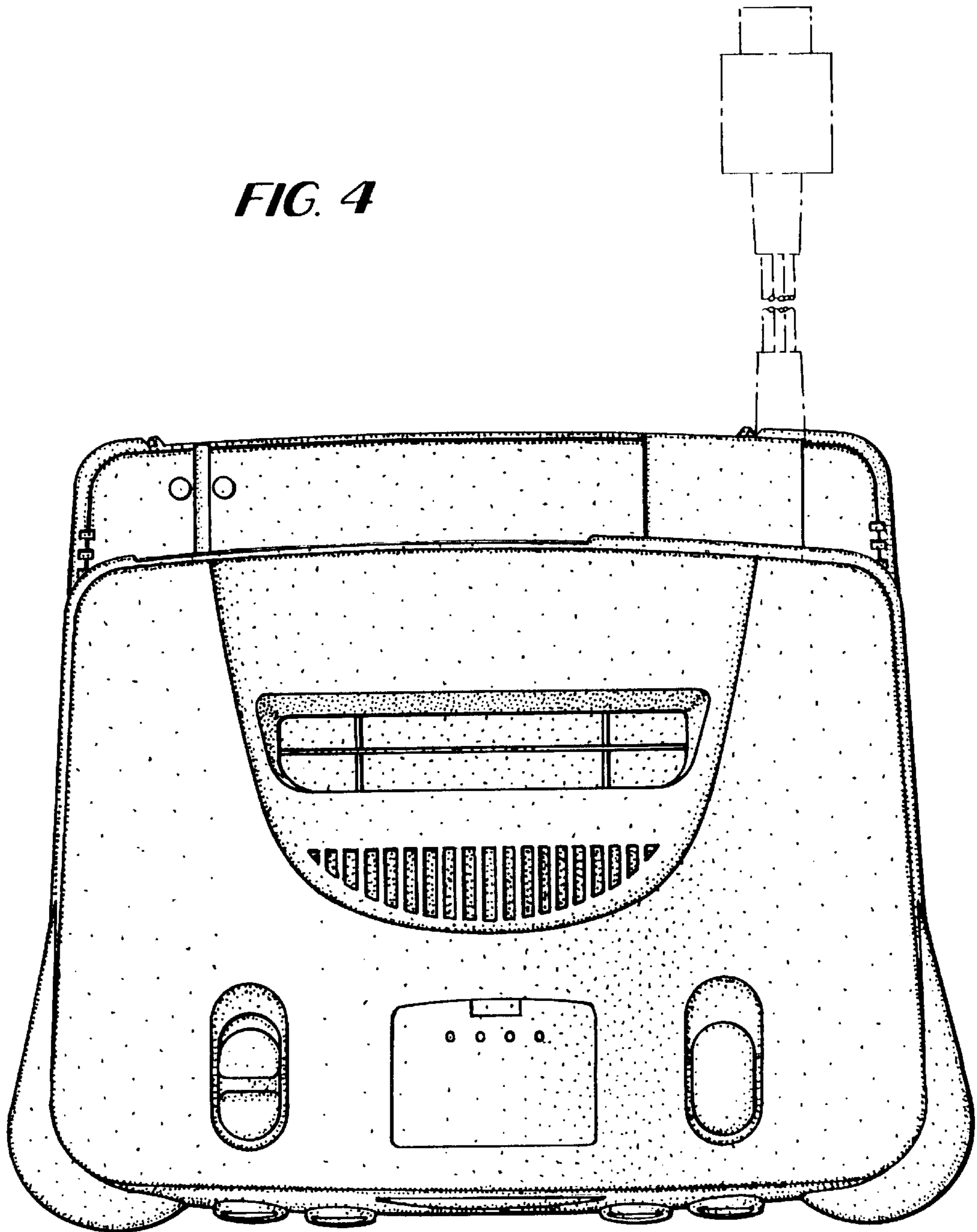
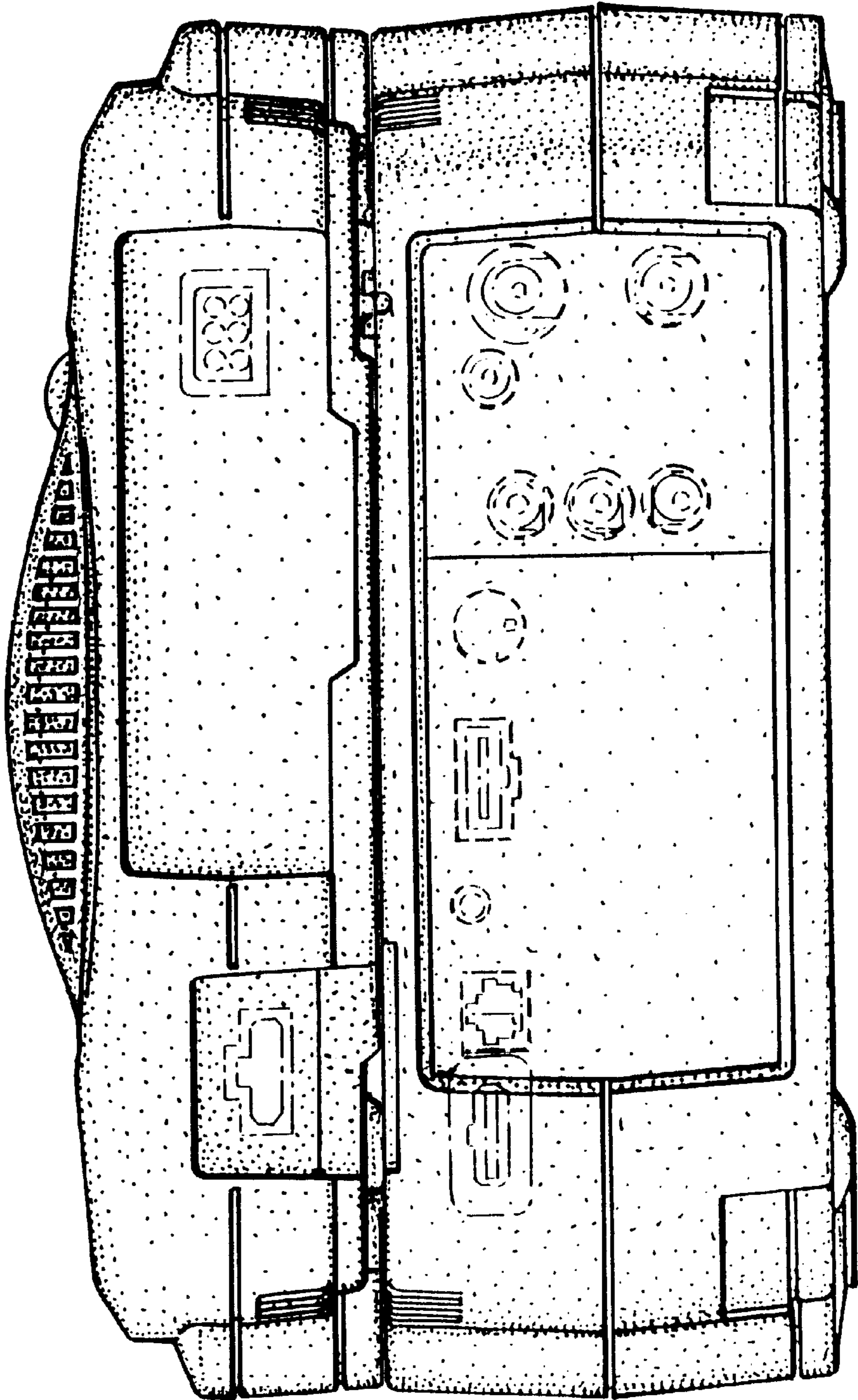

FIG. 5



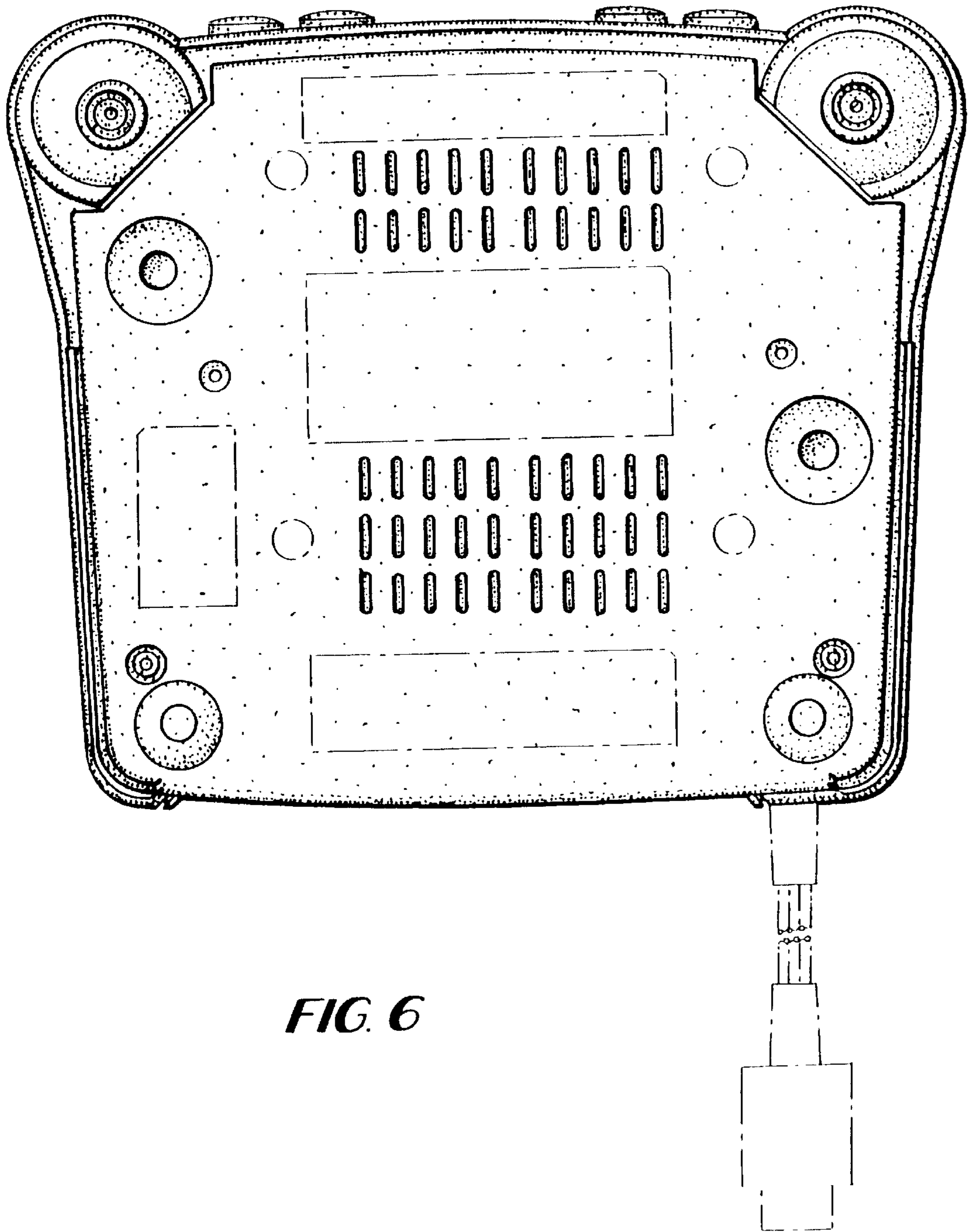

FIG. 6

FIG. 7

