



US00D419155S

United States Patent [19]

Nagele et al.

[11] Patent Number: **Des. 419,155**

[45] Date of Patent: **** Jan. 18, 2000**

[54] **CELLULAR TELEPHONE HOUSING**

[75] Inventors: **Albert L. Nagele**, Wilmette; **Victor J. Hukill**, Elgin, both of Ill.

[73] Assignee: **Motorola, Inc.**, Schaumburg, Ill.

[**] Term: **14 Years**

[21] Appl. No.: **29/107,316**

[22] Filed: **Jul. 1, 1999**

[51] **LOC (7) Cl.** **14-03**

[52] **U.S. Cl.** **D14/138**

[58] **Field of Search** D14/137, 218, D14/138, 144, 147-148, 247-249, 140-142, 250, 240, 100, 115; 379/433, 434, 419, 420, 428, 440, 368; 455/550-575, 90; D13/168; D18/2, 7

[56] **References Cited**

U.S. PATENT DOCUMENTS

- D. 297,735 9/1988 Soren et al. .
- D. 300,742 4/1989 Soren et al. .
- D. 300,827 4/1989 Soren et al. .
- D. 304,189 10/1989 Nagele et al. .
- D. 305,427 1/1990 Soren et al. .
- D. 306,298 2/1990 Sawada et al. .
- D. 318,050 7/1991 Elbaz et al. .
- D. 321,349 11/1991 Colida .
- D. 325,028 3/1992 Nagele et al. .
- D. 325,029 3/1992 Nagele et al. .
- D. 326,092 5/1992 Kikuchi et al. .
- D. 336,087 6/1993 Siddoway et al. .
- D. 340,711 10/1993 Nagele et al. .
- D. 342,248 12/1993 Nagele et al. .
- D. 343,615 1/1994 Taylor .
- D. 343,616 1/1994 Nagele et al. .
- D. 345,158 3/1994 Namba et al. D14/138
- D. 345,356 3/1994 Ando et al. .
- D. 347,221 5/1994 Siddoway .
- D. 352,503 11/1994 Nagele .
- D. 359,734 6/1995 Nagele et al. .
- D. 361,064 8/1995 Fellingner .
- D. 369,598 5/1996 Nagele et al. .
- D. 385,873 11/1997 Nagele et al. D14/138
- D. 393,856 4/1998 Lee et al. .

- D. 408,402 4/1999 Shimelfarb et al. .
- 4,481,382 11/1984 Villa-Real .
- 4,845,772 7/1989 Metroka et al. .
- 4,926,474 5/1990 Marks .
- 5,027,394 6/1991 Ono et al. .
- 5,260,998 11/1993 Takagi .
- 5,335,368 8/1994 Tamura 455/90
- 5,493,604 2/1996 Hirayama 455/564
- 5,493,690 2/1996 Shimazaki 455/575

FOREIGN PATENT DOCUMENTS

- 2-274046A 11/1990 Japan .
- 6-152459A 5/1994 Japan .

OTHER PUBLICATIONS

Mobile Computing & Communications, p. 100, Motorola StarTAC, (Dec. 1996).
 Mobile Computing & Communication, p. 104, Motorola StarTAC Select 9000, (May 1997).
 NTT DoCoMo, Digital MoVa, 9600 bps Hyper cellular telephone advertisement (Jun. 1995).
 NTT DoCoMo, Digital MoVa cellular telephone advertisement (Apr. 1994).

Primary Examiner—Jeffrey Asch
Attorney, Agent, or Firm—Sylvia Chen

[57] **CLAIM**

The ornamental design for a cellular telephone housing, as shown and described.

DESCRIPTION

FIG. 1 is a front, bottom, and left side perspective view of a first embodiment of a cellular telephone housing in a closed position;
 FIG. 2 is a front, bottom, and left side perspective view of the first embodiment in an opened position;
 FIG. 3 is a right side elevation view of the first embodiment in a closed position;
 FIG. 4 is a front elevation view of the first embodiment in a closed position;
 FIG. 5 is a bottom plan view of the first embodiment in a closed position;
 FIG. 6 is a top plan view of the first embodiment in a closed position;
 FIG. 7 is a left side elevation view of the first embodiment in a closed position;

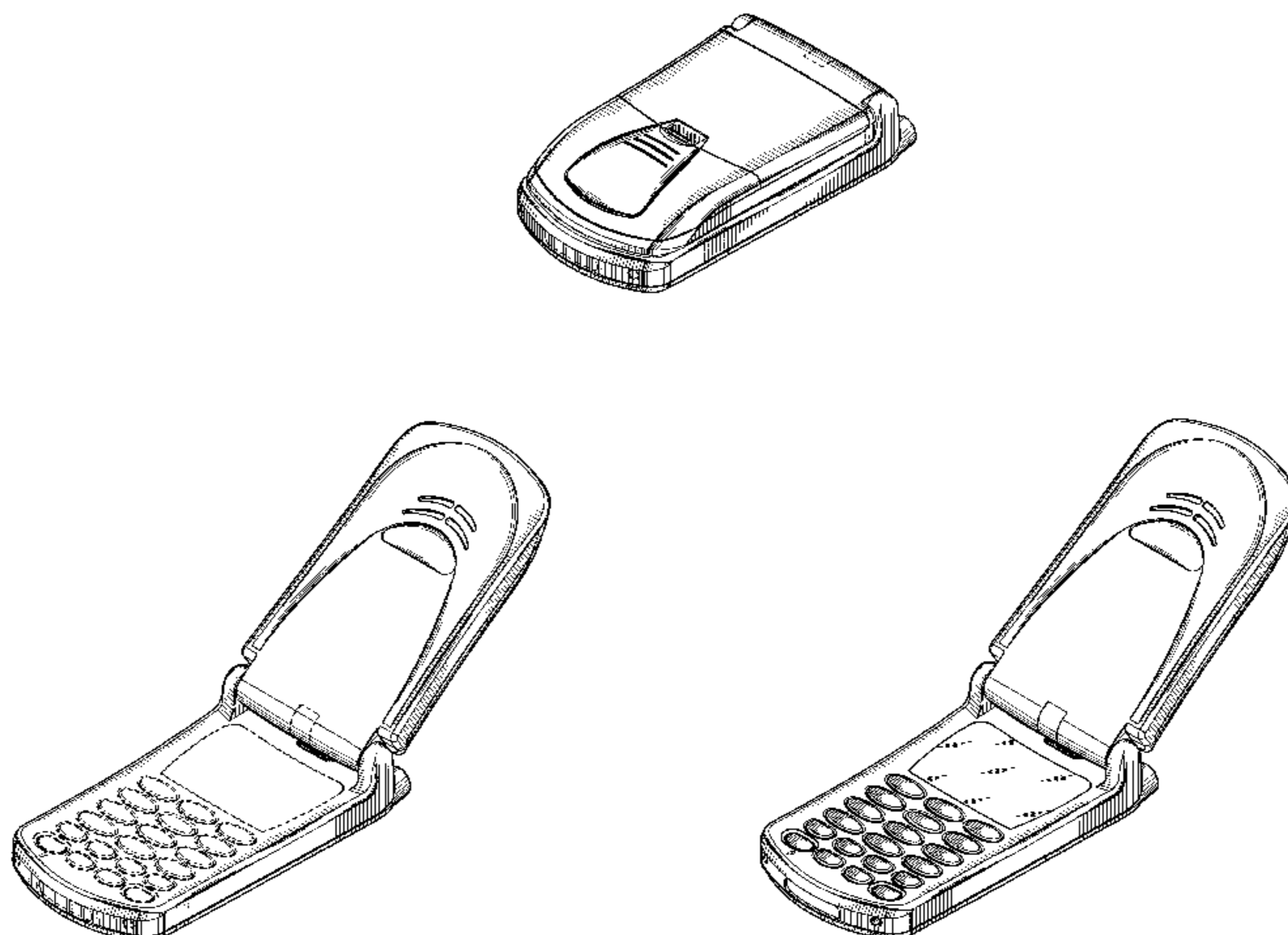

FIG. 8 is a rear elevation view of the first embodiment in a closed position;

FIG. 9 is a front, bottom, and left side perspective view of a second embodiment of a cellular telephone housing in a closed position;

FIG. 10 is a front, bottom, and left side perspective view of the second embodiment in an opened position;

FIG. 11 is a right side elevation view of the second embodiment in a closed position;

FIG. 12 is a front elevation view of the second embodiment in a closed position;

FIG. 13 is a bottom plan view of the second embodiment in a closed position;

FIG. 14 is a top plan view of the second embodiment in a closed position;

FIG. 15 is a left side elevation view of the second embodiment in a closed position; and,

FIG. 16 is a rear elevation view of the second embodiment in a closed position.

The broken line matter in all figures is for illustrative purposes only and forms no part of the claimed design.

1 Claim, 8 Drawing Sheets

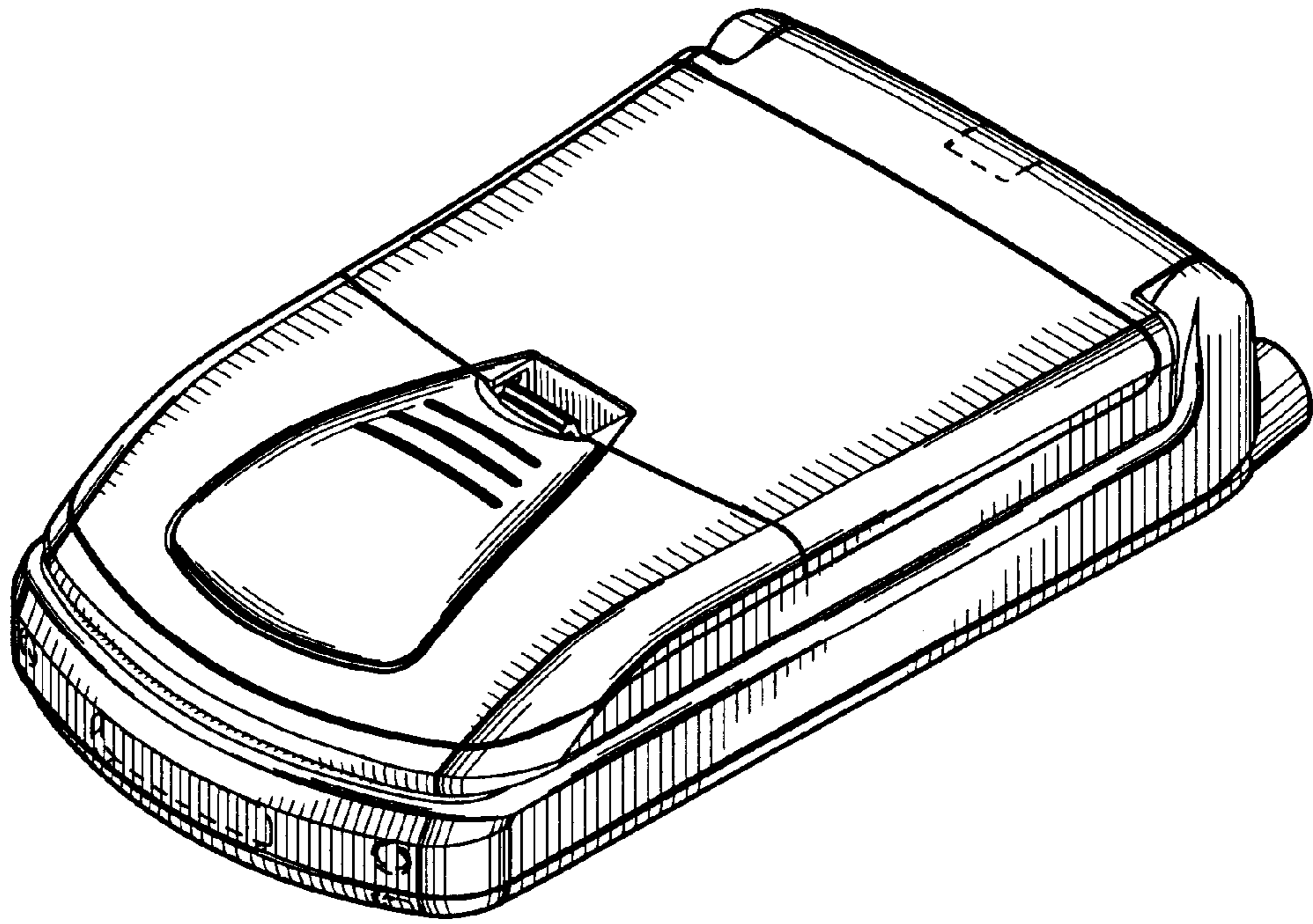

FIG. 1

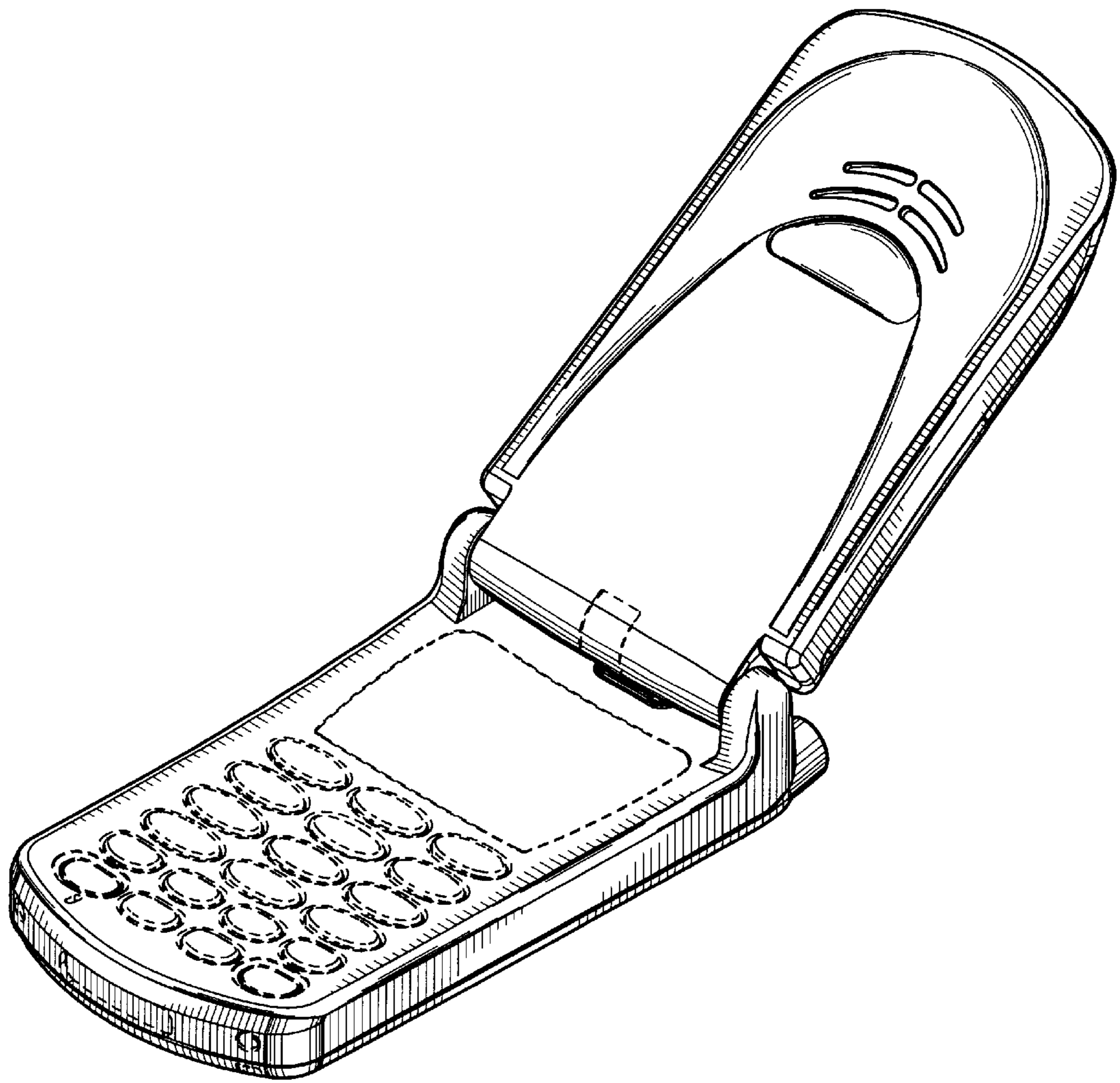

FIG. 2

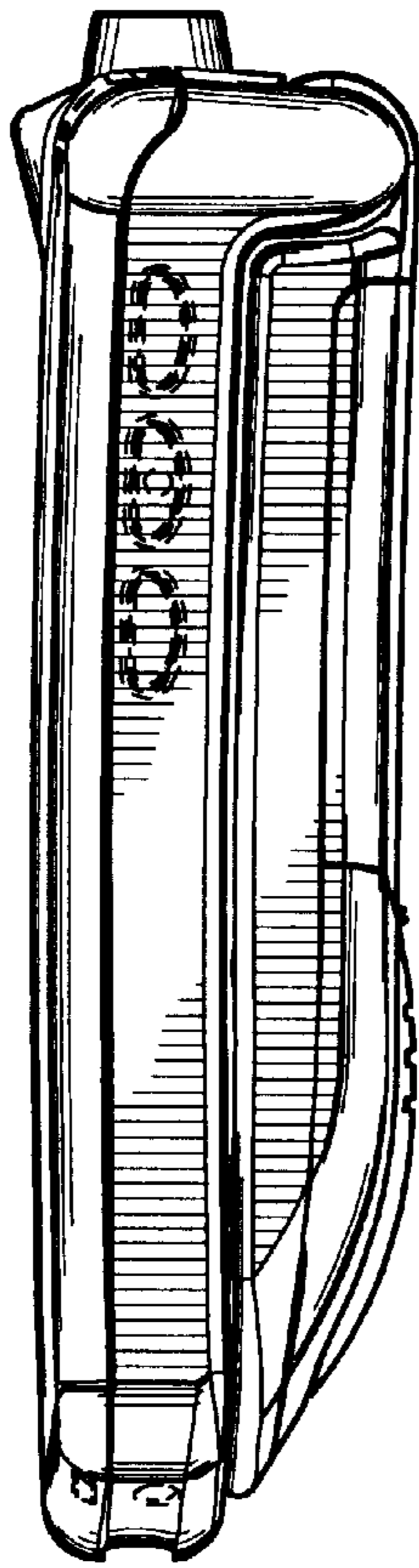

FIG. 3

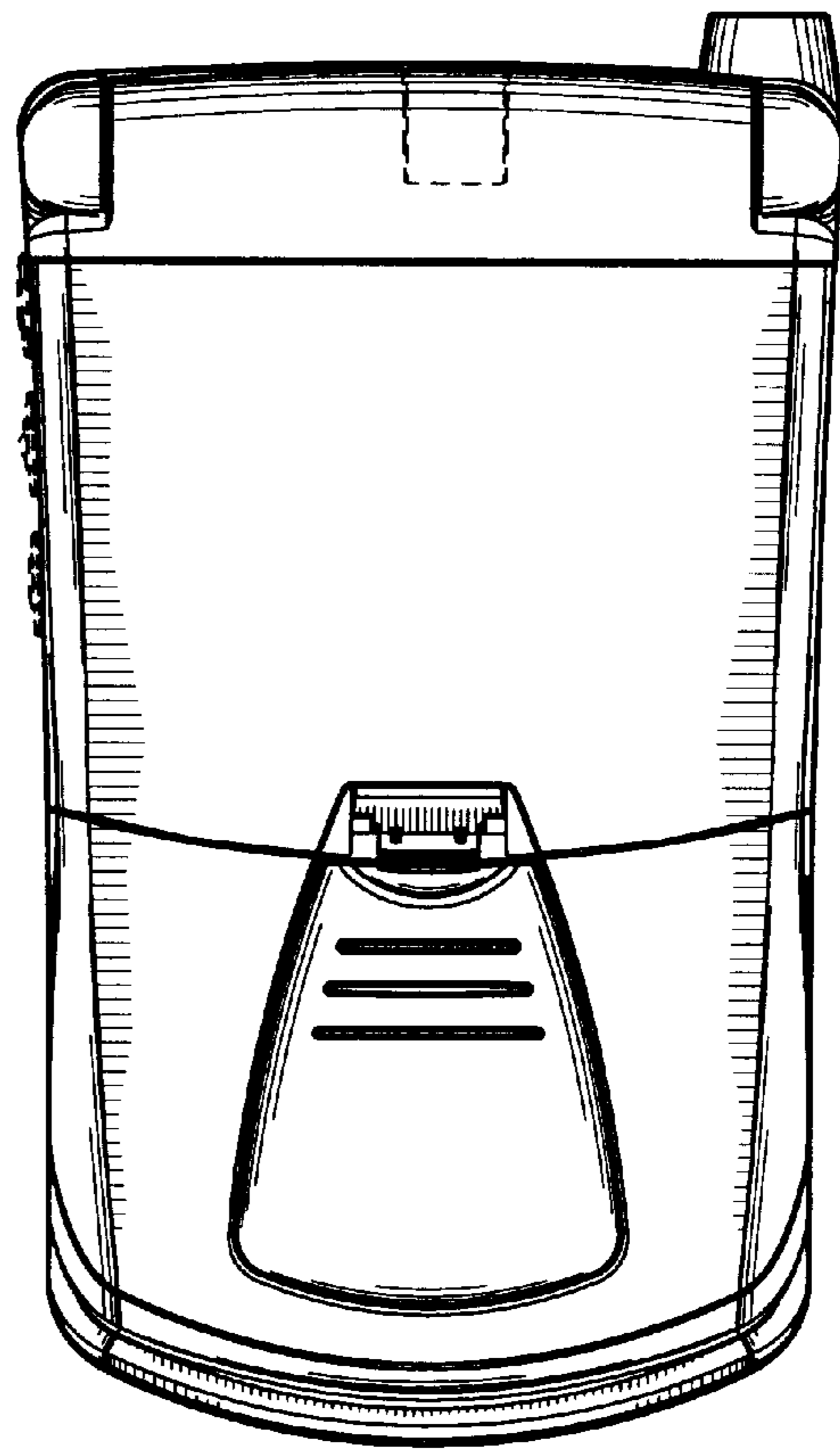

FIG. 4

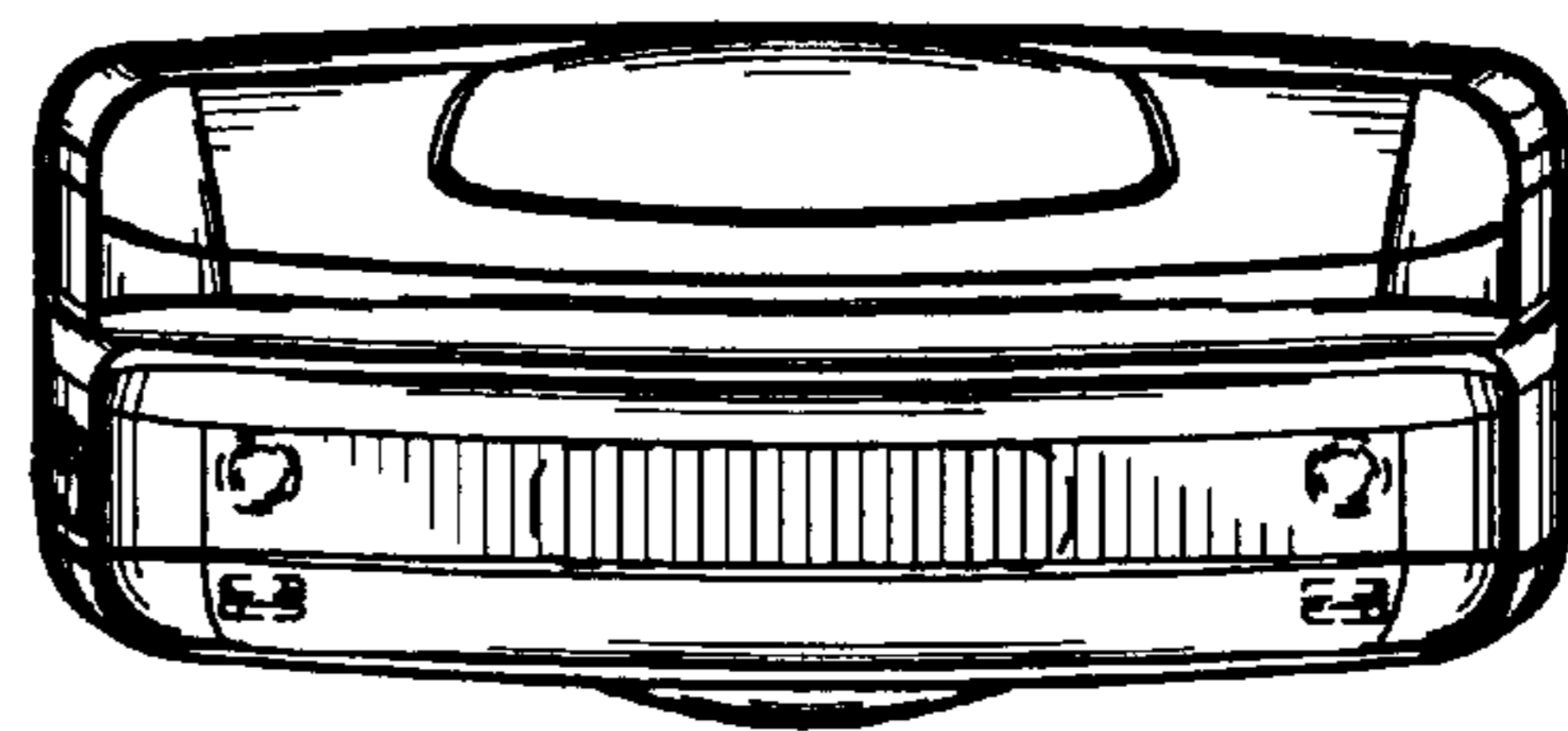

FIG. 5

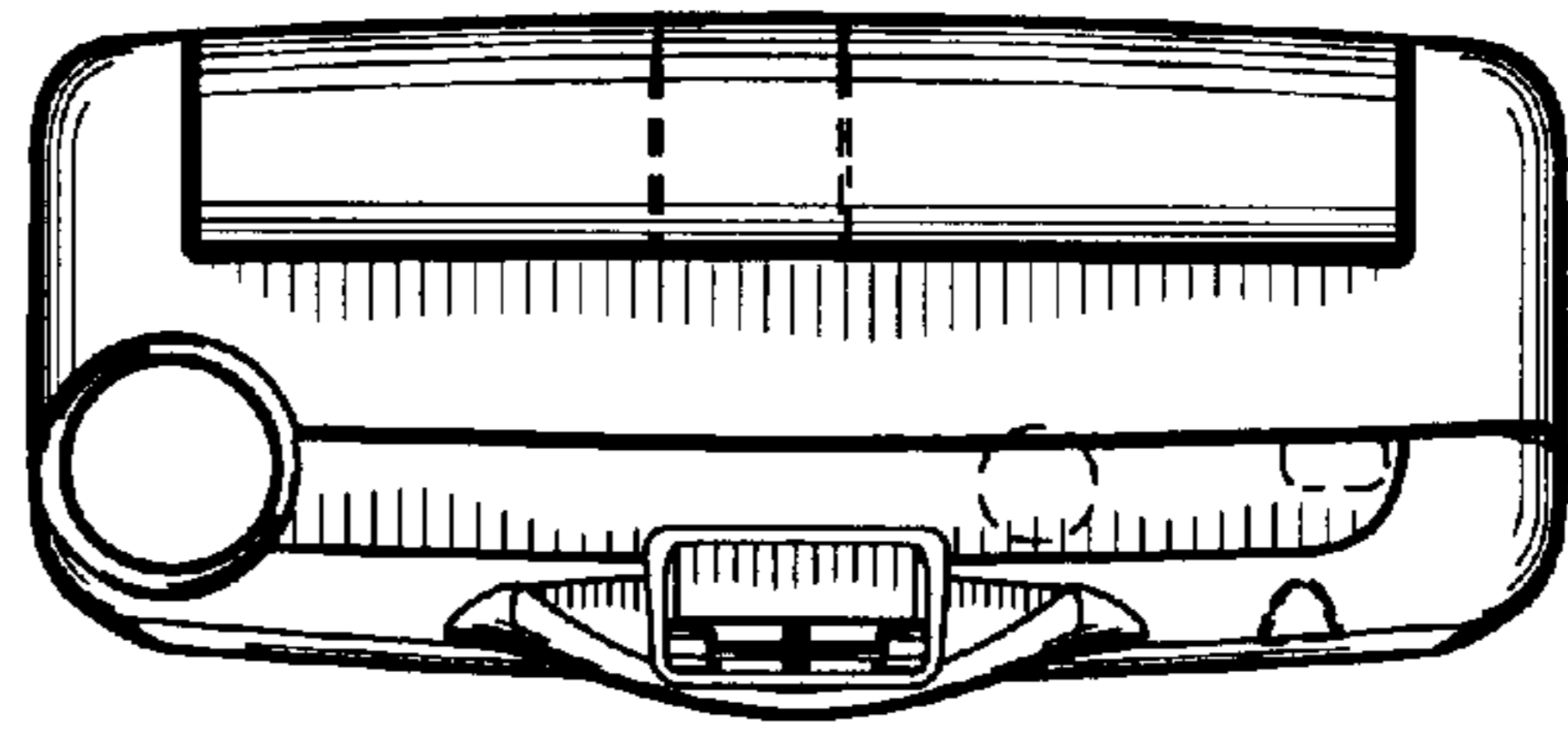

FIG. 6

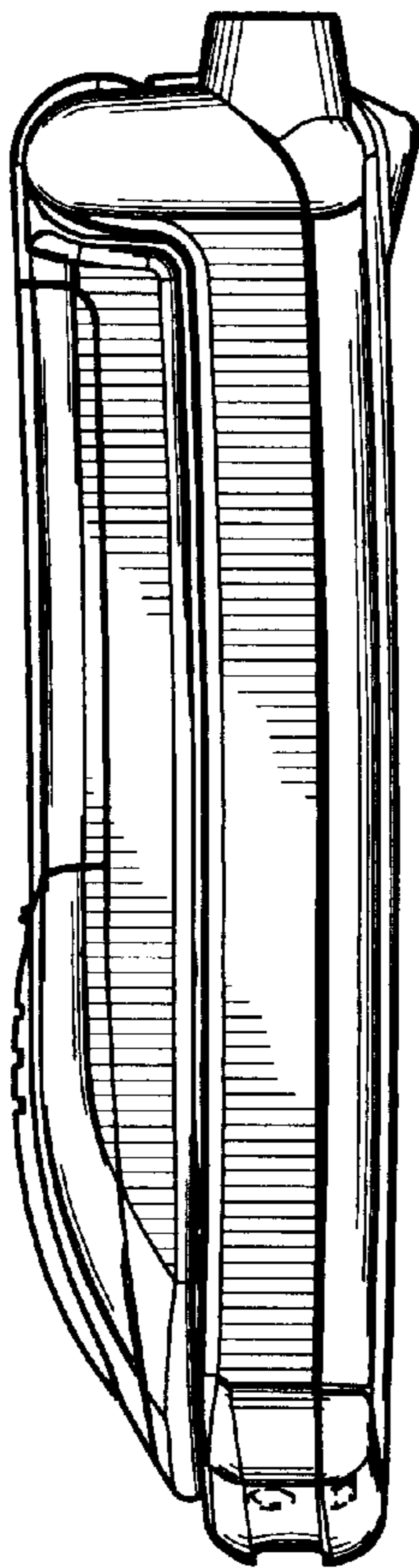

FIG. 7

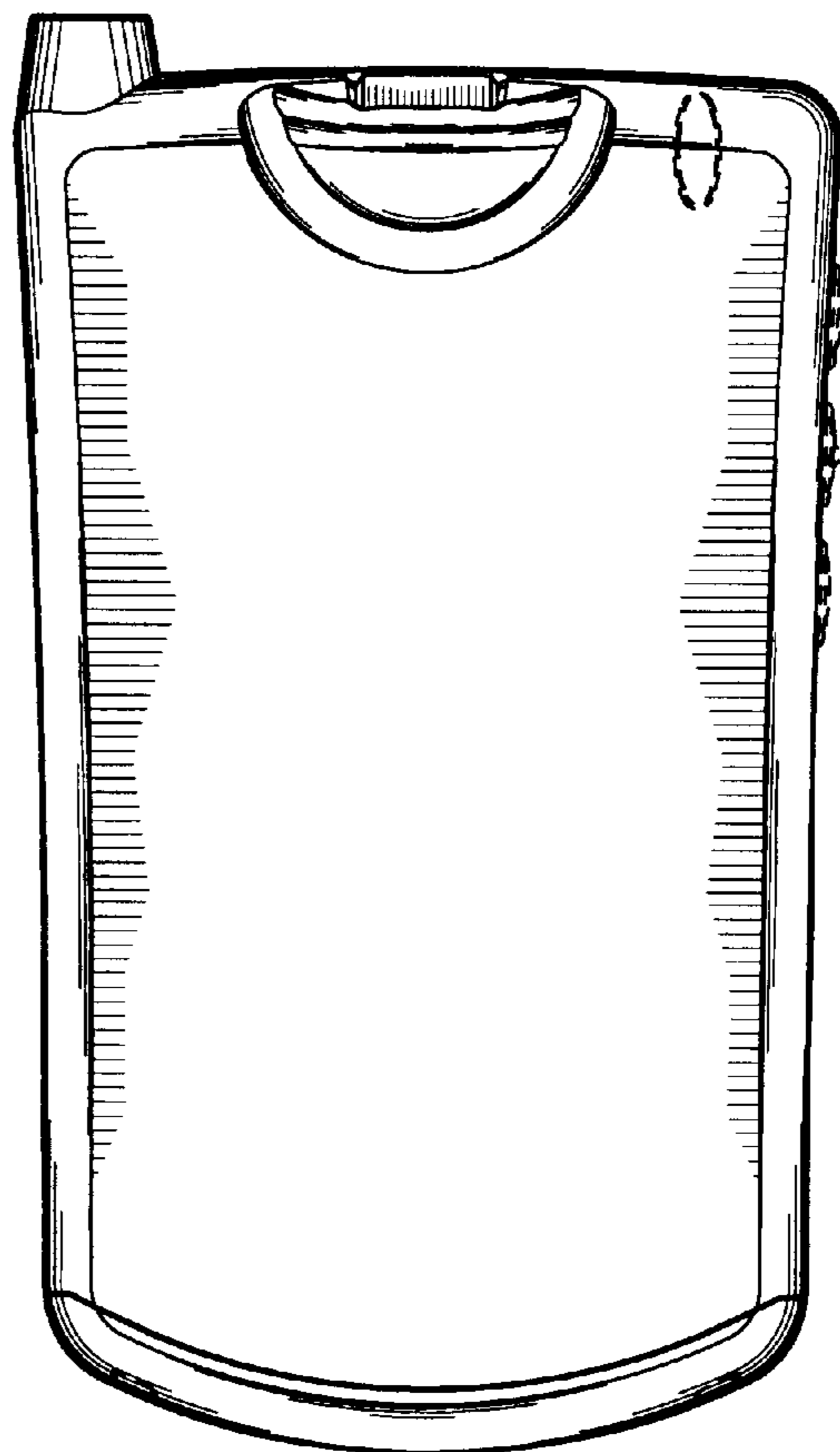

FIG. 8

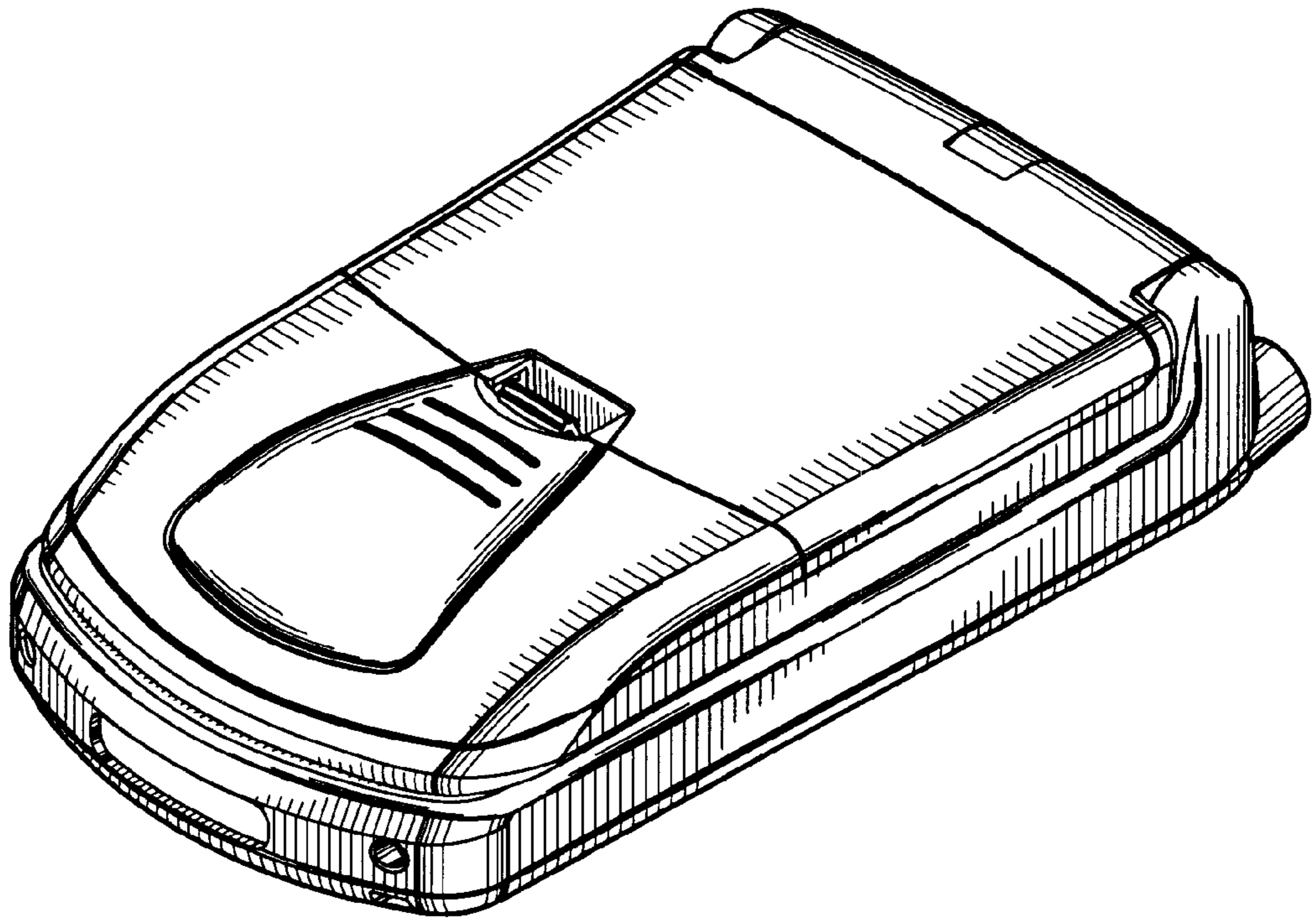

FIG. 9

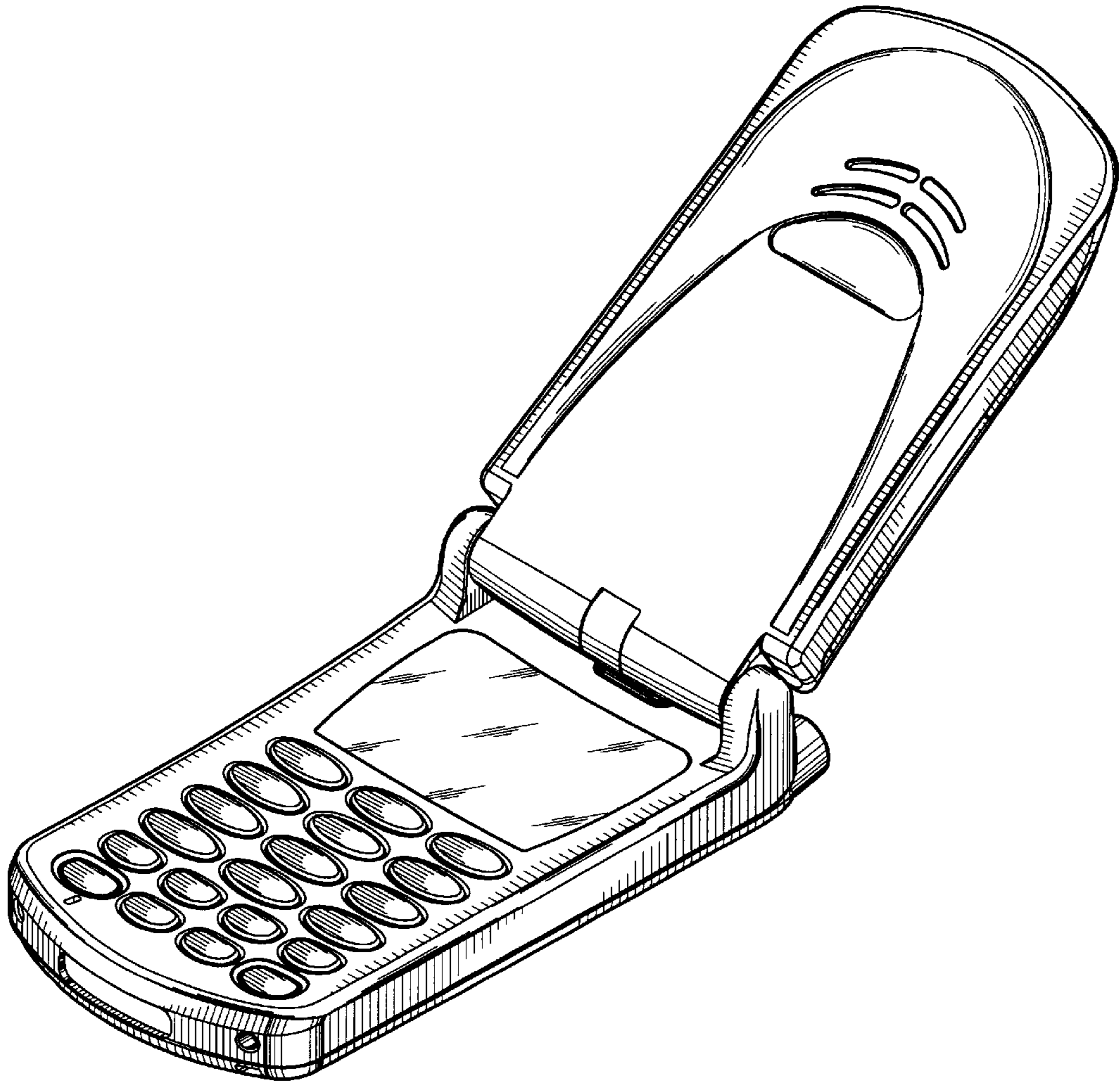

FIG. 10

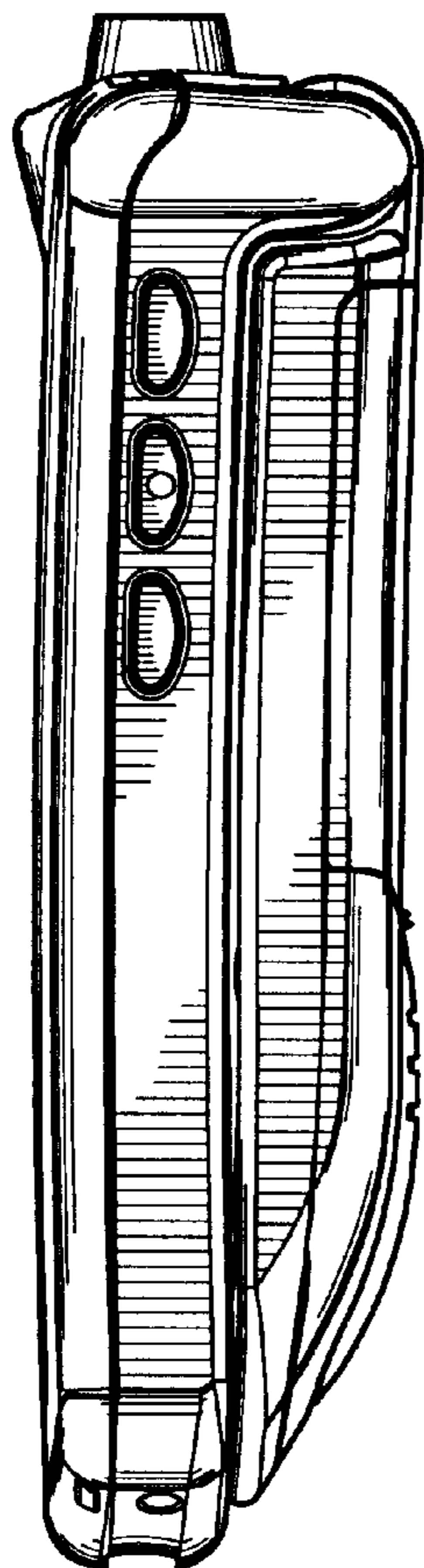

FIG. 11

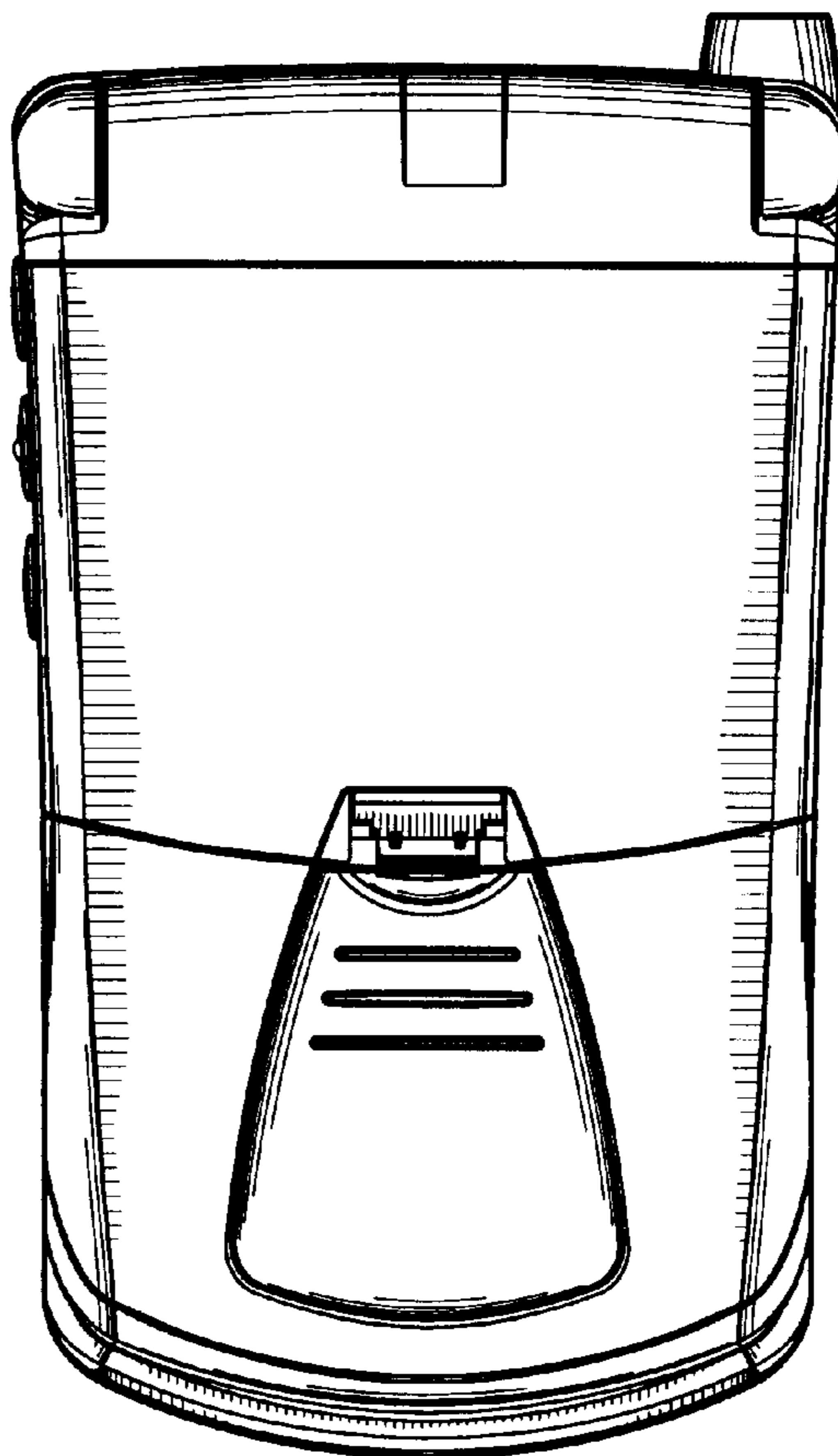

FIG. 12

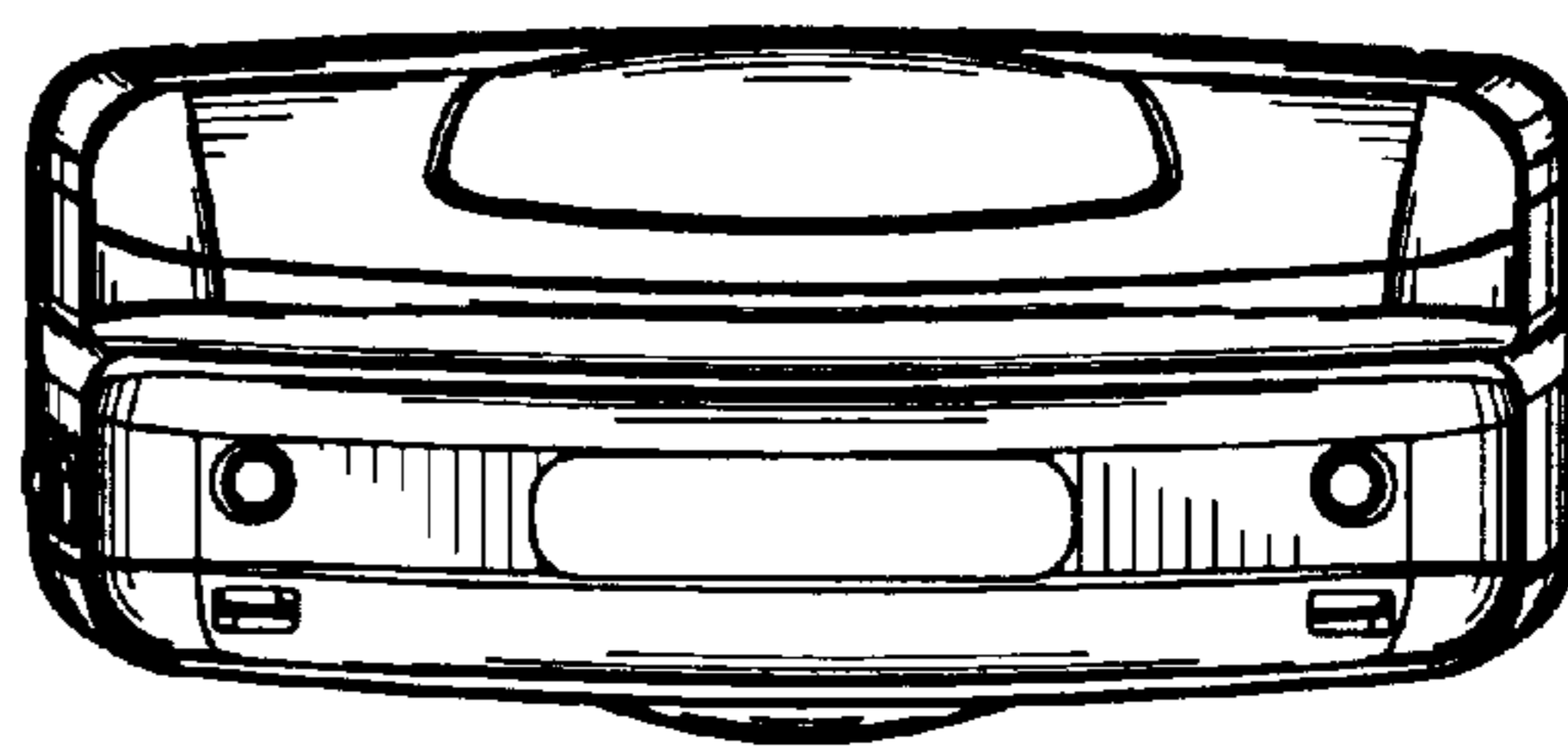

FIG. 13

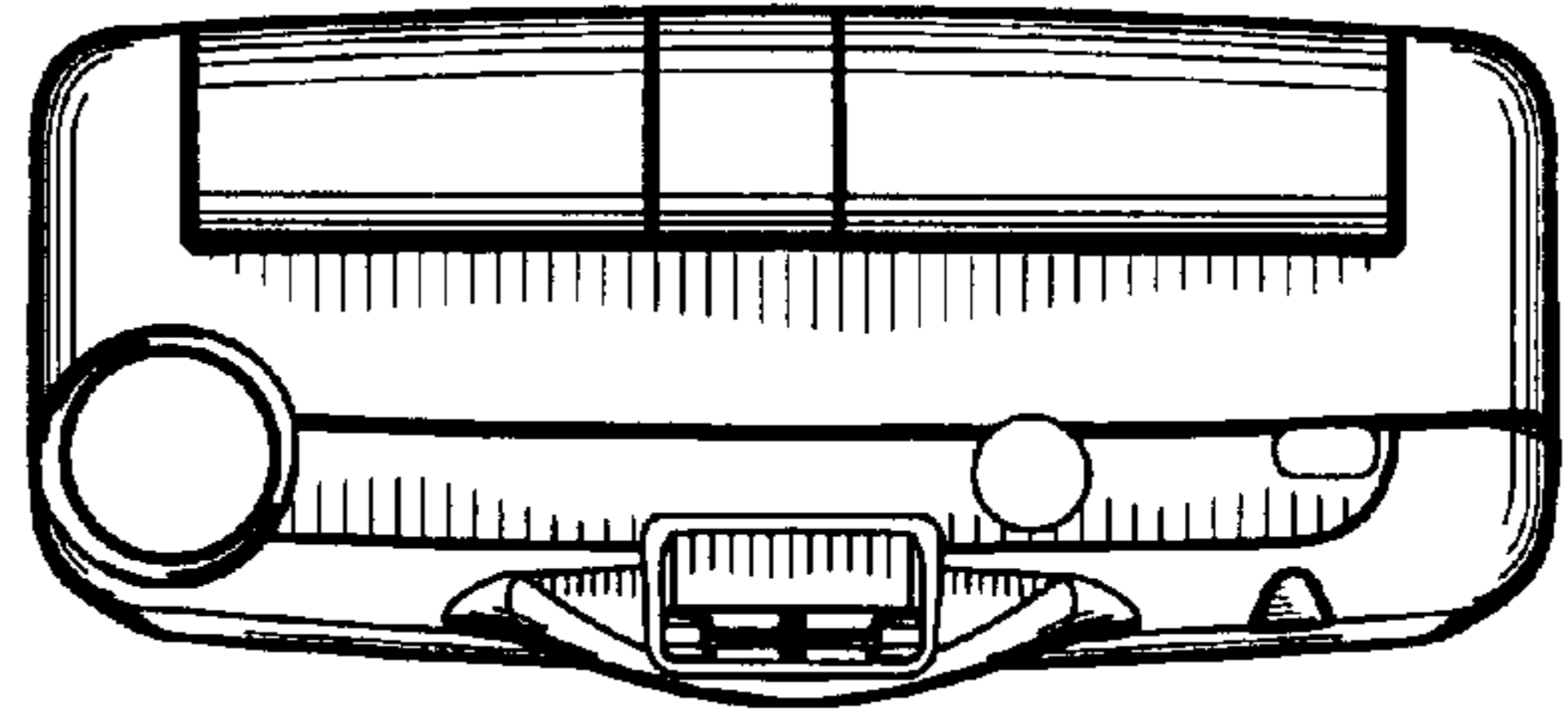

FIG. 14

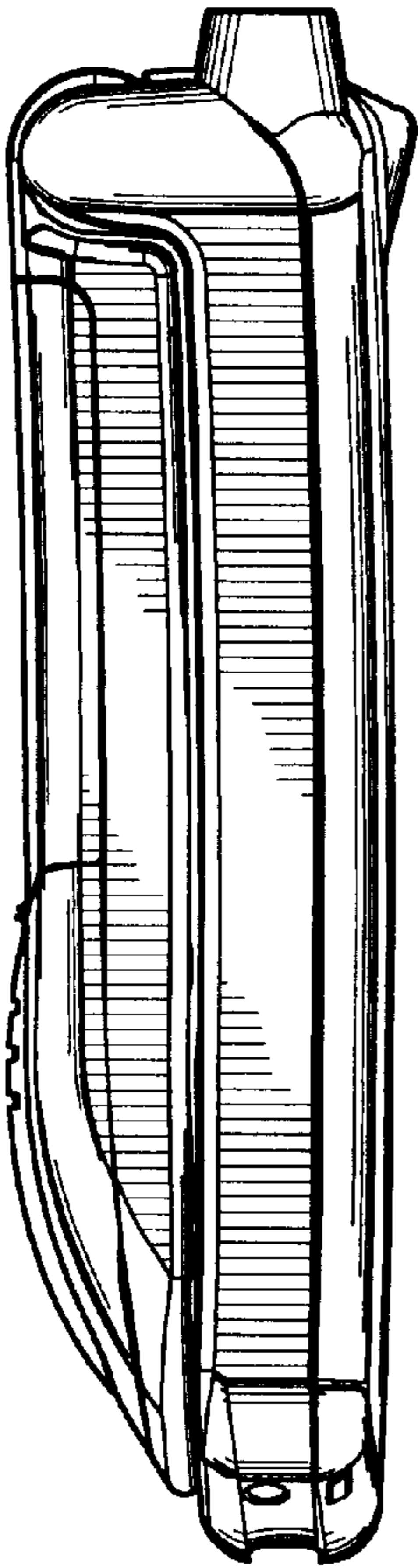

FIG. 15

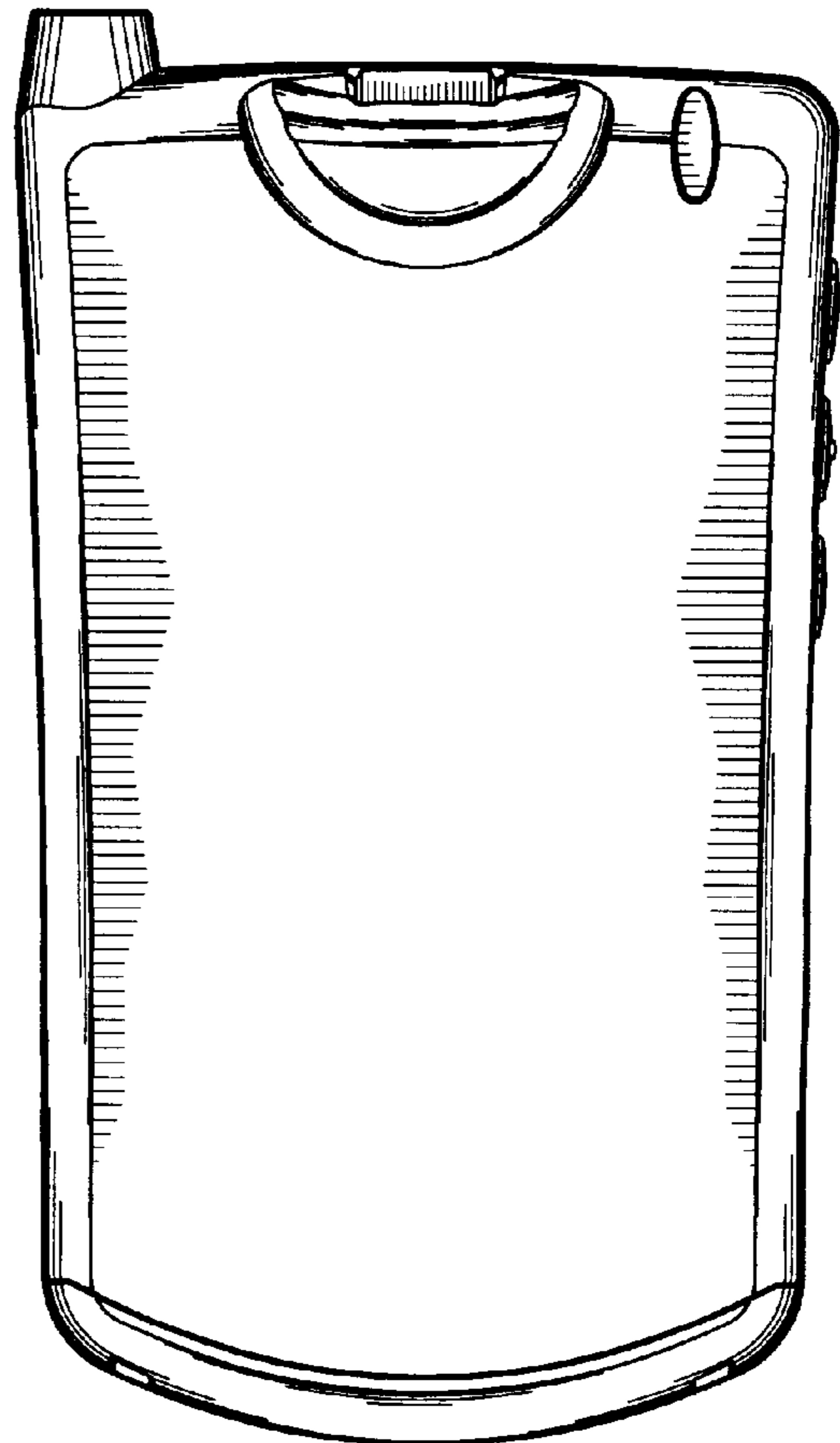

FIG. 16