



US00D419152S

United States Patent [19] Lowenstein

[11] **Patent Number: Des. 419,152**

[45] **Date of Patent: ** Jan. 18, 2000**

[54] **COMPACT DISK/MINI DISK**

[75] Inventor: **Rod Lowenstein**, Jericho, N.Y.

[73] Assignee: **Shape CD, Inc.**, New York, N.Y.

[**] Term: **14 Years**

[21] Appl. No.: **29/100,480**

[22] Filed: **Feb. 11, 1999**

[51] **LOC (7) Cl.** **14-99**

[52] **U.S. Cl.** **D14/121**; D14/114

[58] **Field of Search** D14/120, 121,
D14/136, 156, 164, 114; D21/324, 332;
242/348-348.4, 335; 360/132, 133, 135,
900; 206/307, 308.1, 308.2, 308.3; 369/275.1-275.5,
280, 281, 287, 288, 292

[56] **References Cited**

U.S. PATENT DOCUMENTS

D. 193,785	10/1962	Campbell et al.	D14/121
D. 231,470	4/1974	Klepa et al.	D14/114
D. 394,648	5/1998	Rohde	D14/121
3,495,839	2/1970	Kelly	369/280 X
4,091,454	5/1978	Kauffman	360/135
4,486,496	12/1984	Dezawa et al.	360/135 X
5,043,974	8/1991	Nakagawa	369/291
5,717,682	2/1998	Nomoto	369/275.4
5,852,598	12/1998	Wiest	369/291 X
5,882,555	3/1999	Rohde et al.	369/280 X

Primary Examiner—Prabhakar Deshmukh
Attorney, Agent, or Firm—McGlew and Tuttle, P.C.

[57] **CLAIM**

The ornamental design for a compact disk/mini disk, as shown and described.

DESCRIPTION

FIG. 1 is a top plan view of a compact disk/mini disk showing my new design;

FIG. 2 is a bottom plan view thereof;

FIG. 3 is a front view thereof, the back view being identical;

FIG. 4 is a right side view thereof, the left side being identical;

FIG. 5 is a top plan view of another embodiment of a compact disk/mini disk showing my new design;

FIG. 6 is a bottom plan view thereof;

FIG. 7 is a front view thereof, the back view being identical;

FIG. 8 is a right side view thereof, the left side being identical;

FIG. 9 is a top plan view of another embodiment of a compact disk/mini disk showing my new design;

FIG. 10 is a bottom plan view thereof;

FIG. 11 is a front view thereof, the back view being identical; and,

FIG. 12 is a right side view thereof, the left side being identical.

1 Claim, 3 Drawing Sheets

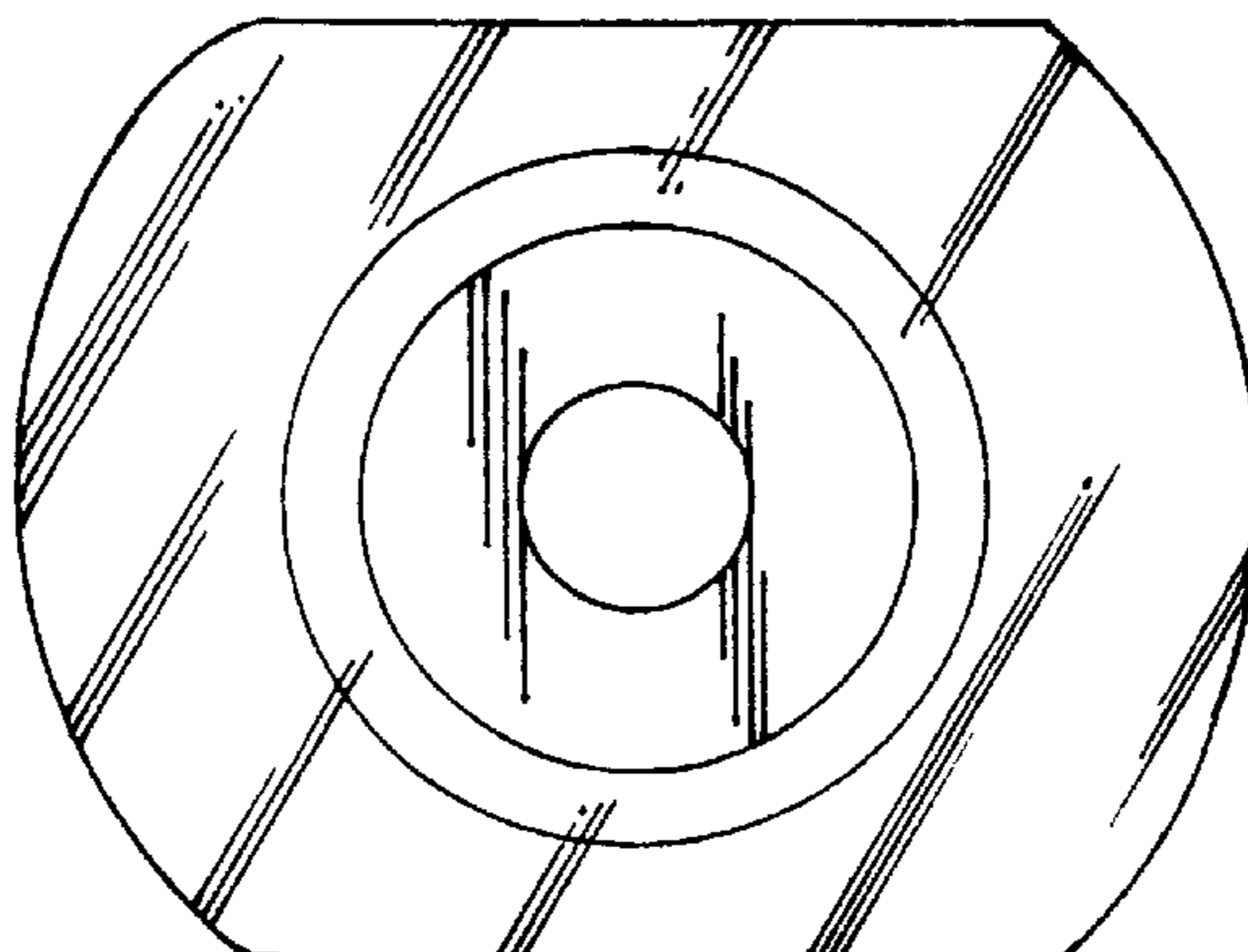
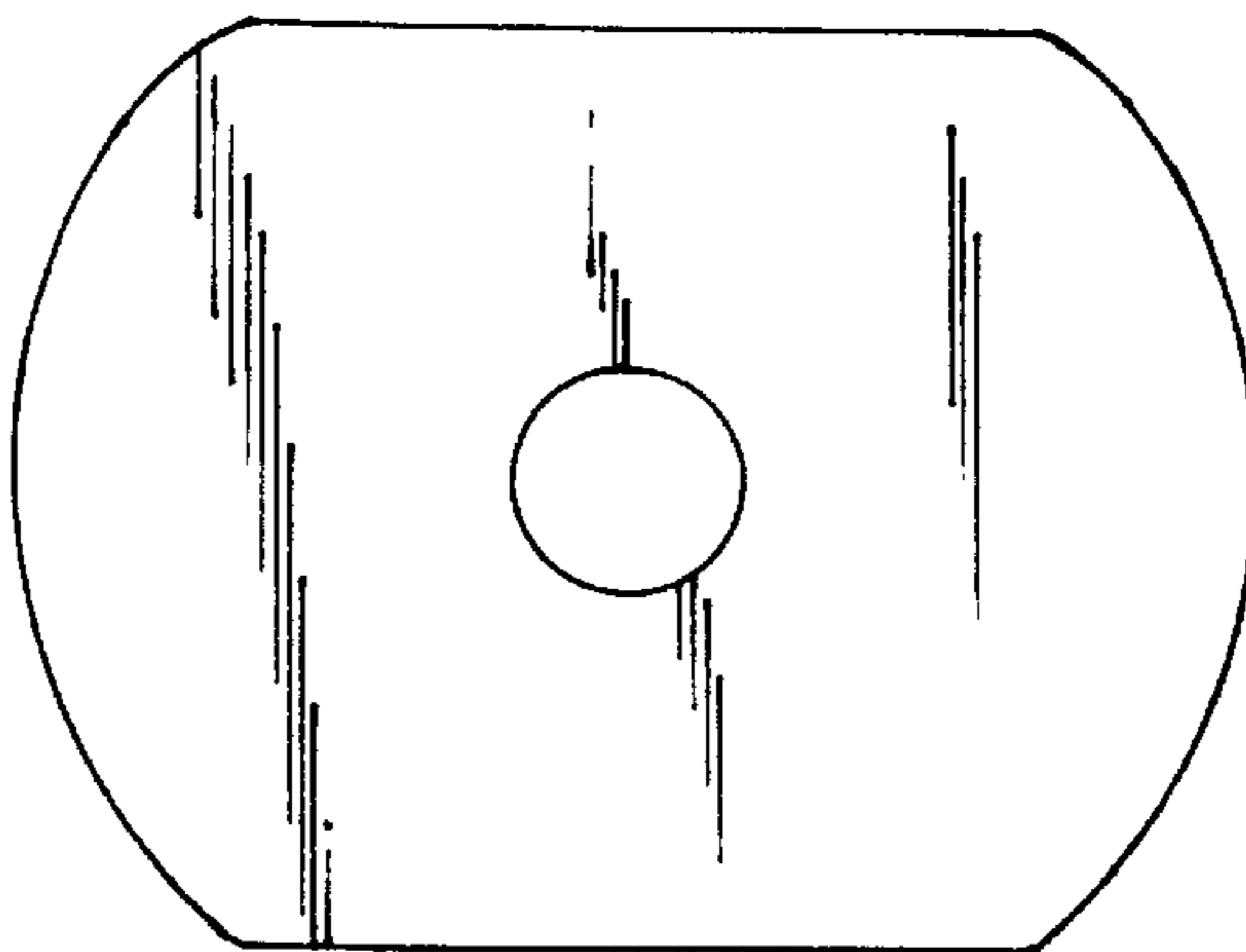

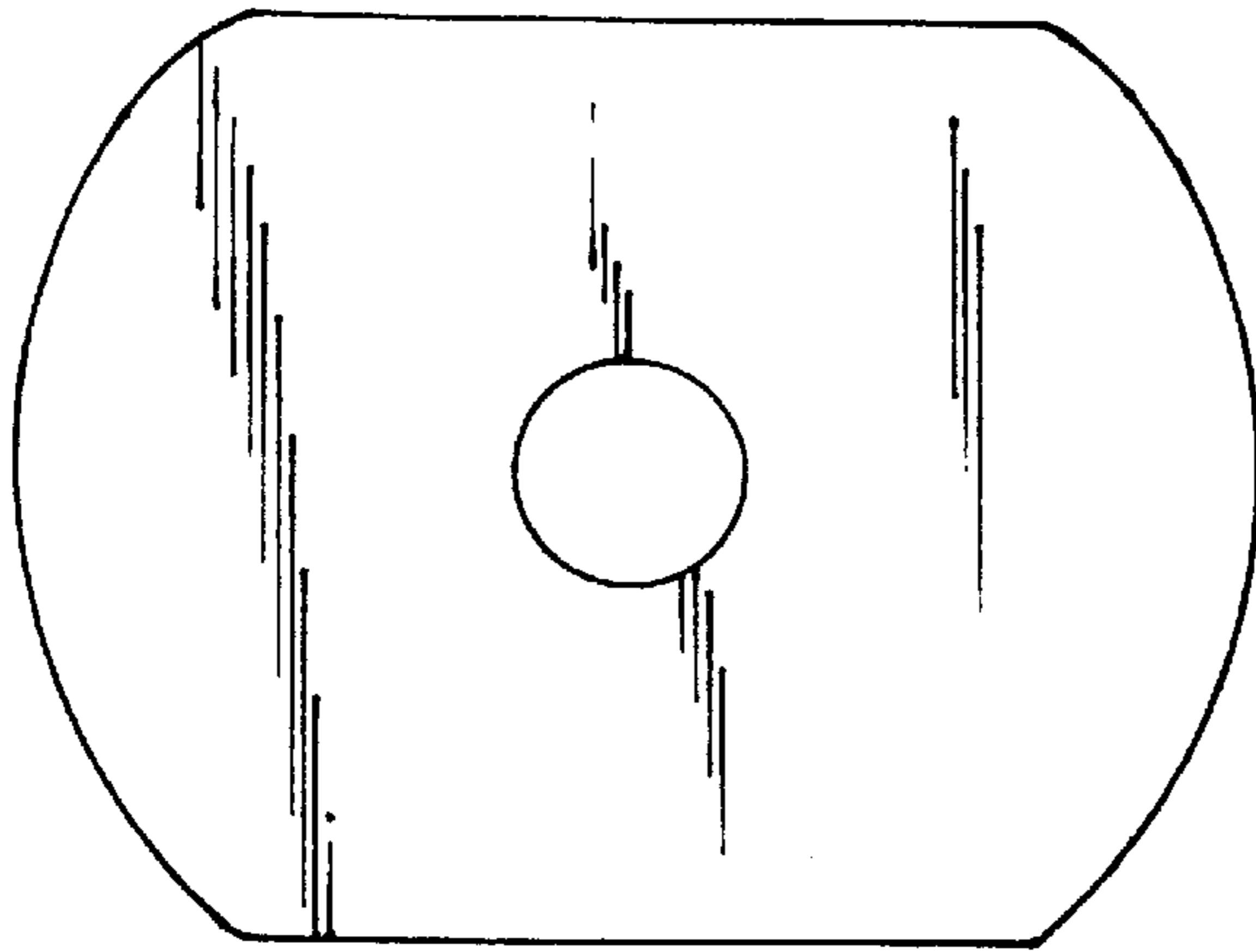

FIG. 1

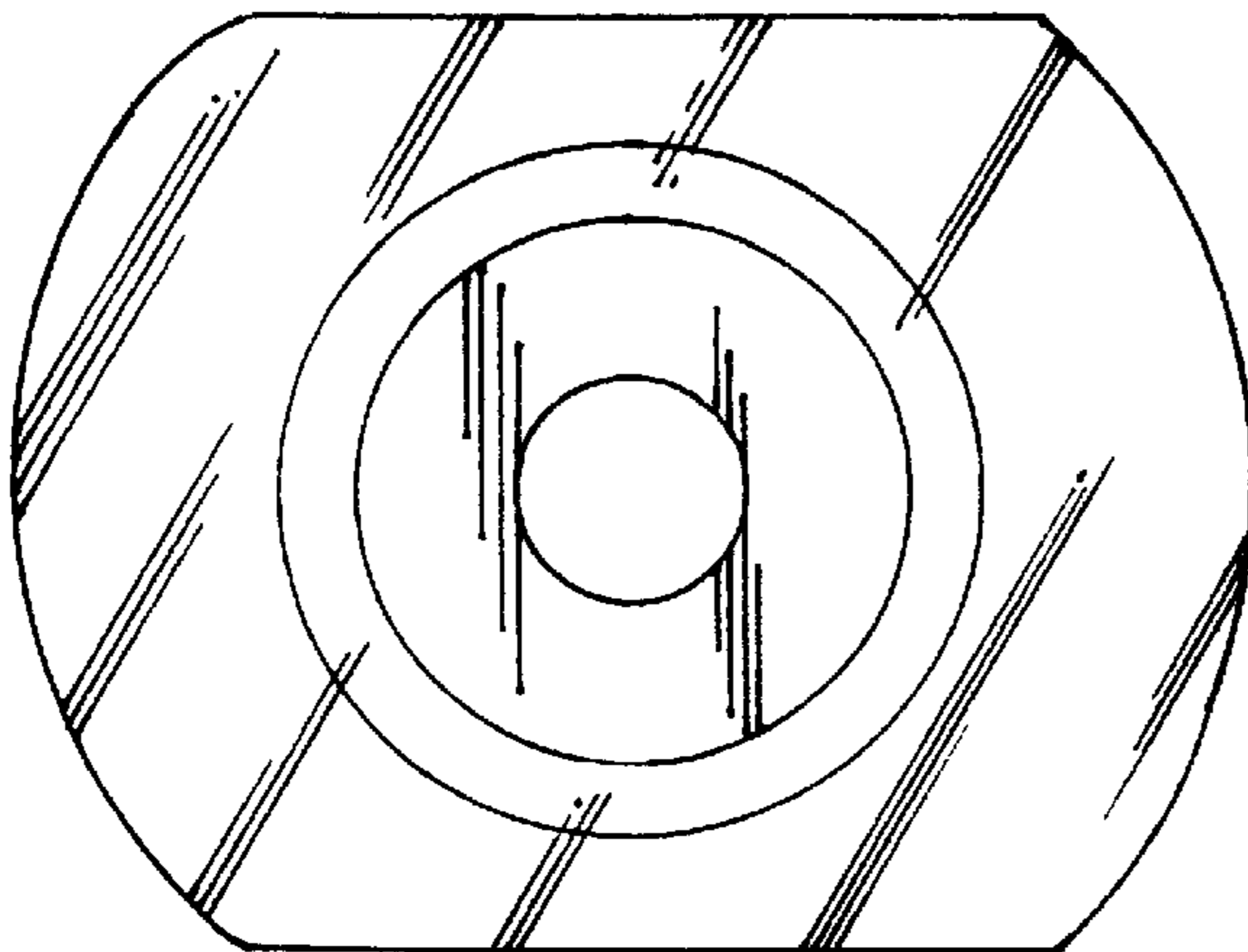

FIG. 2

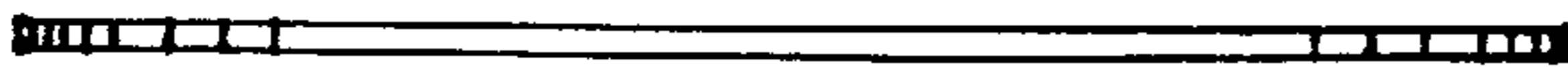

FIG. 3

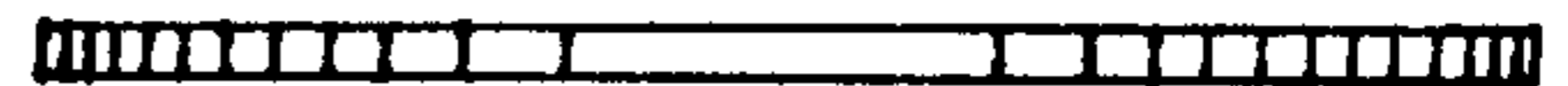

FIG. 4

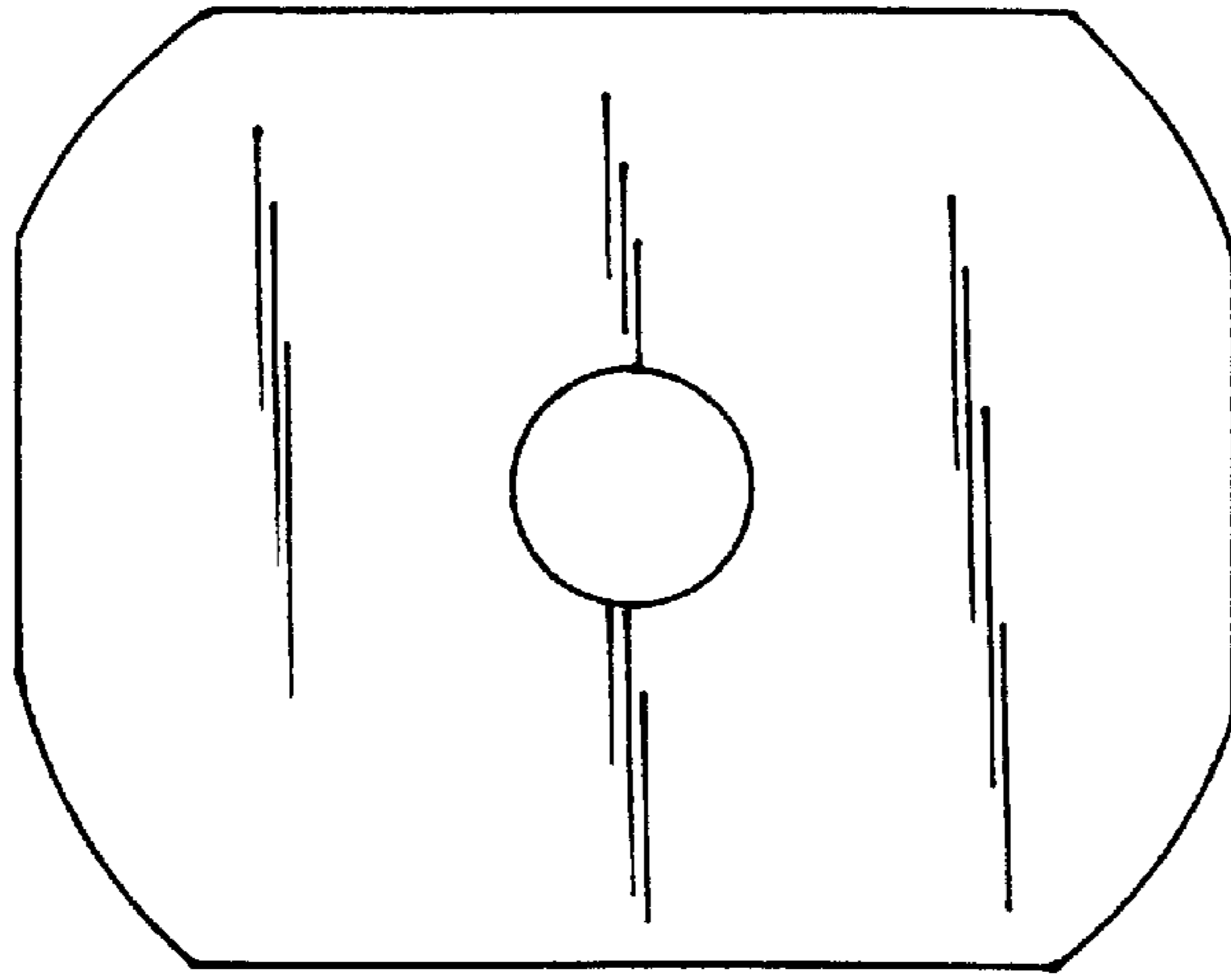

FIG. 5

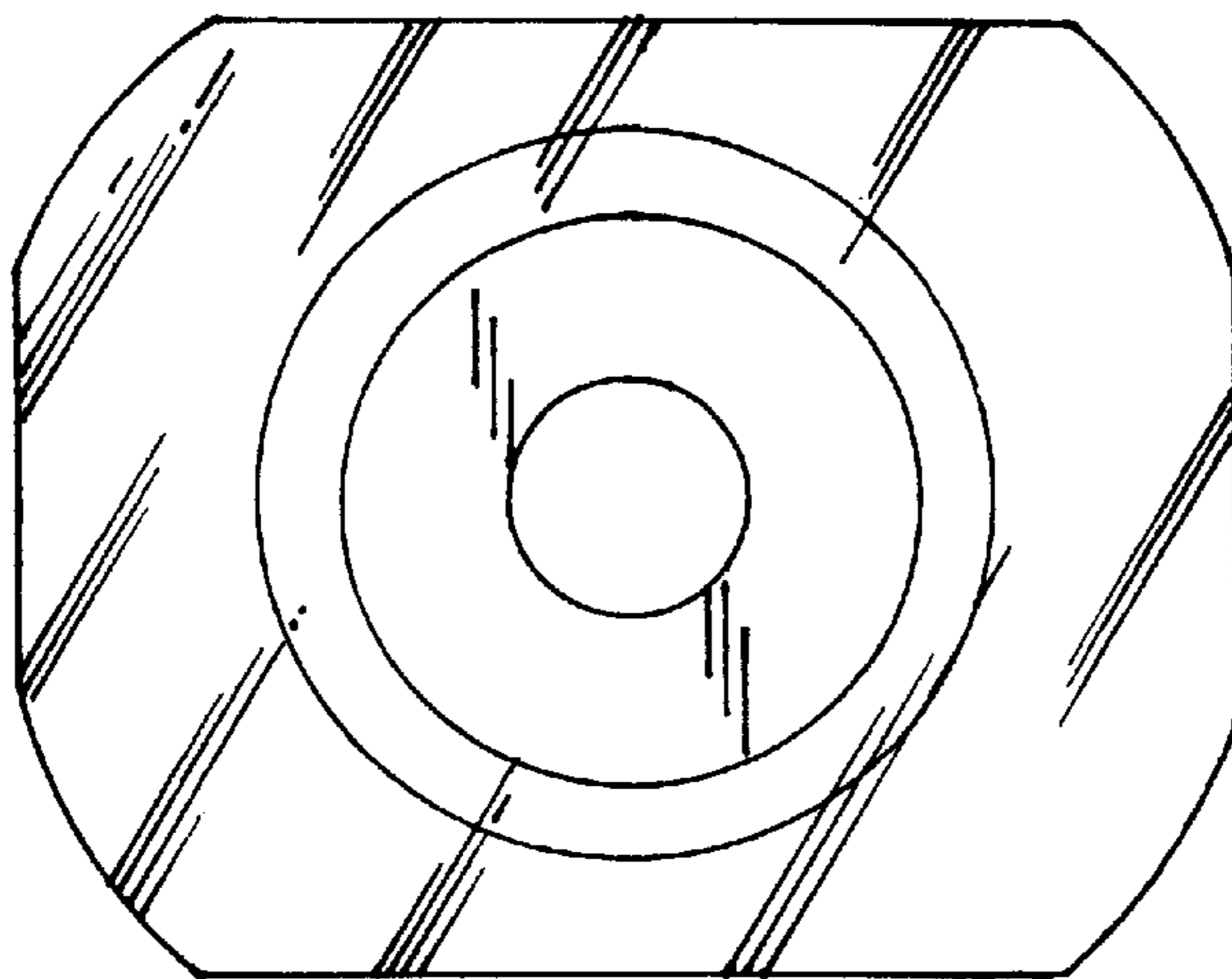

FIG. 6

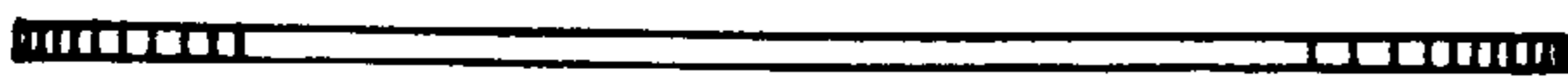

FIG. 7

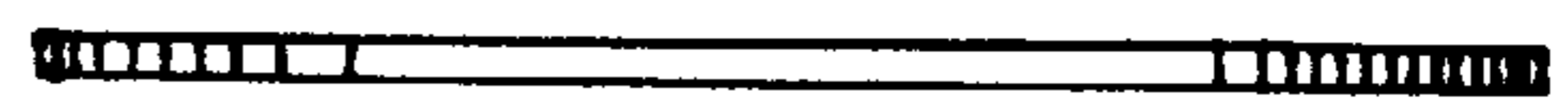

FIG. 8

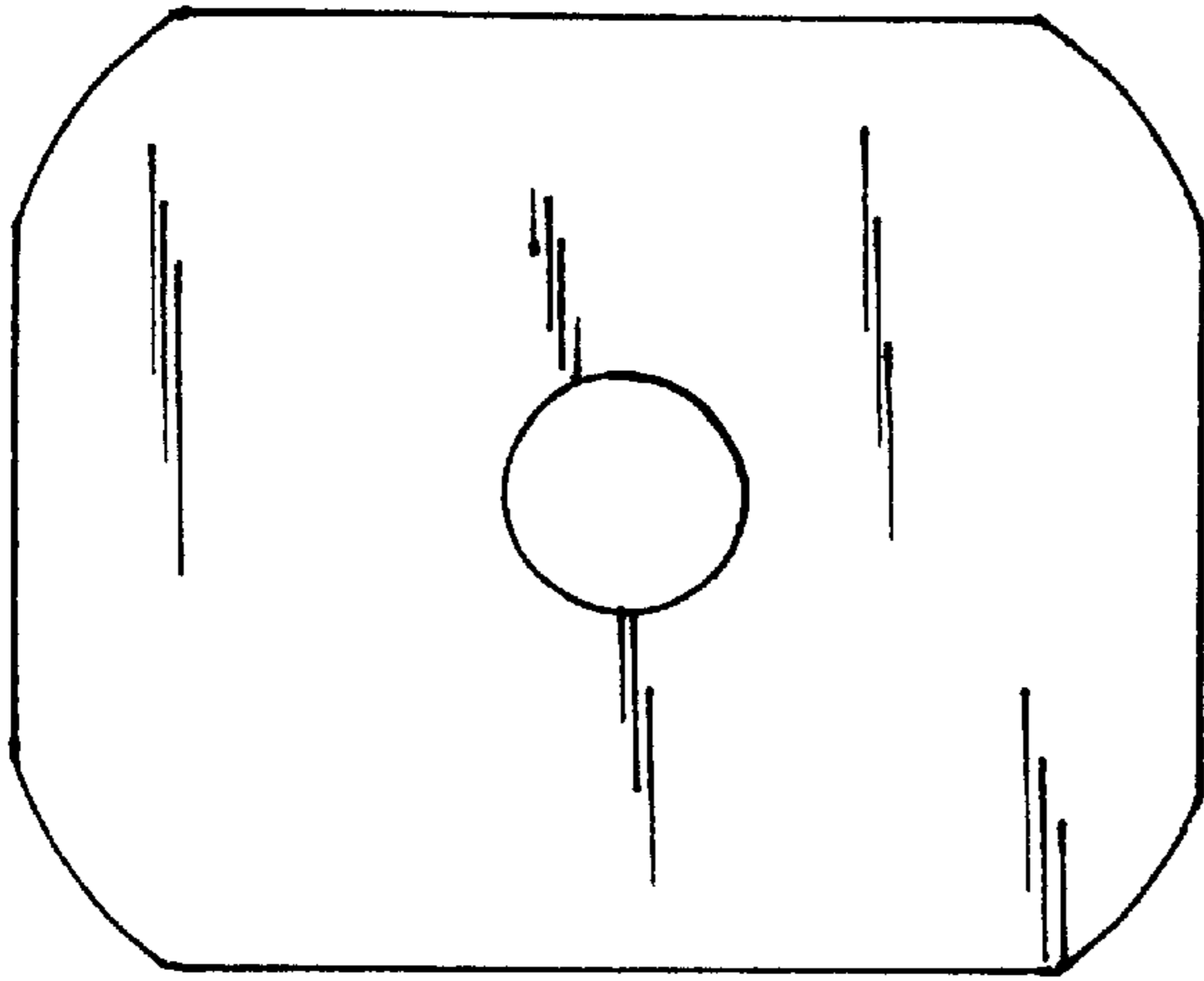

FIG. 9

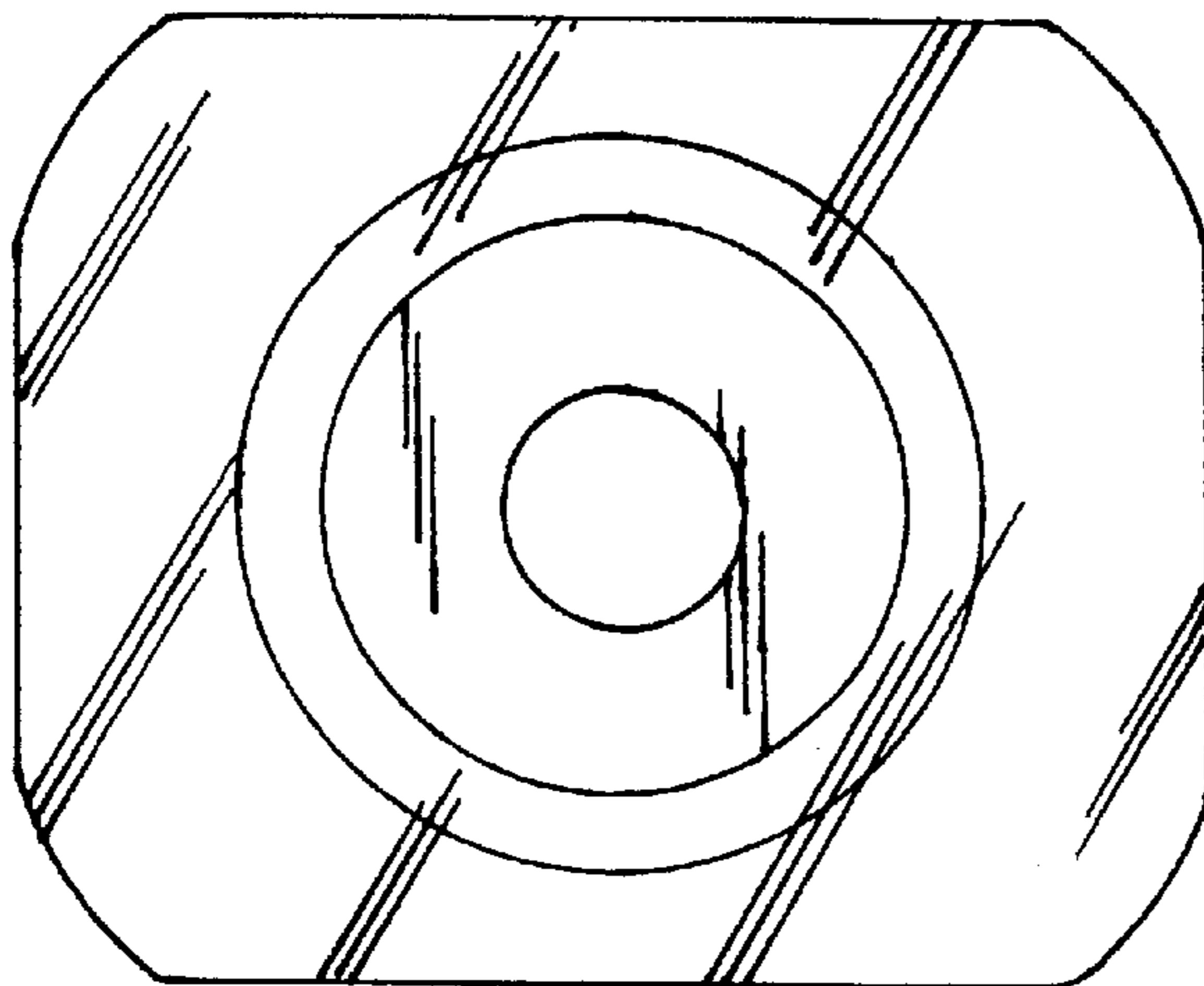

FIG. 10

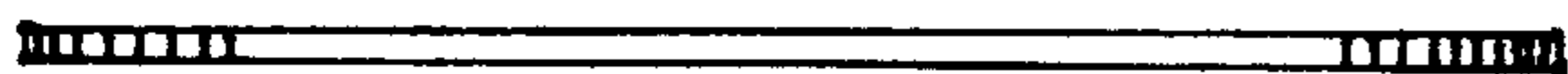

FIG. 11

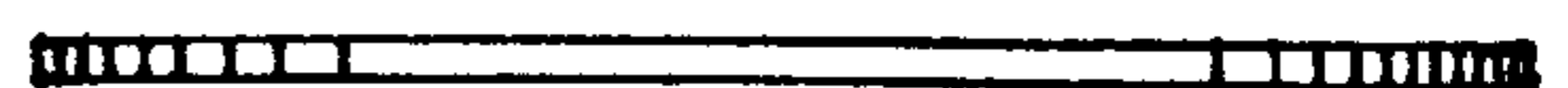

FIG. 12