



US00D419062S

United States Patent [19]

[11] **Patent Number: Des. 419,062**

Feldmeier et al.

[45] **Date of Patent: ** Jan. 18, 2000**

[54] **CARTON FOR MULTIPLE INDIVIDUALLY PACKAGED PRODUCTS**

[75] Inventors: **Daniel R. Feldmeier**, Mt. Horeb;
Carolyn Abbott, Waunakee, both of Wis.

[73] Assignee: **Kraft Foods, Inc.**, Madison, Wis.

[**] Term: **14 Years**

[21] Appl. No.: **29/084,431**

[22] Filed: **Mar. 3, 1998**

[51] **LOC (7) Cl.** **09-03**

[52] **U.S. Cl.** **D9/346**

[58] **Field of Search** D9/337, 341, 345-347,
D9/414; 229/108, 149, 162, 242, 406, 906;
206/1.7, 737

[56] **References Cited**

U.S. PATENT DOCUMENTS

D. 270,225	8/1983	Chiulli	D9/341
D. 287,464	12/1986	Mode	D9/346
D. 338,620	8/1993	Brozowski	D9/430
D. 339,523	9/1993	Bennett	D9/414
1,670,498	5/1928	Einson	229/108
2,283,950	5/1942	Ringler	229/149
2,285,991	6/1942	Lester	229/149

3,166,229	1/1965	Sherman et al.	229/242
3,244,352	4/1966	Reach	229/906
3,376,972	4/1968	Sobel	206/1.7
5,337,948	8/1994	Newsome et al.	229/162
5,860,589	1/1999	Hsu	229/162

Primary Examiner—Ted Shooman
Assistant Examiner—Carol Rademaker
Attorney, Agent, or Firm—Cook, Alex, McFarron, Manzo, Cummings & Mehler

[57] **CLAIM**

The ornamental design for a carton for multiple individually packaged products, as shown and described.

DESCRIPTION

FIG. 1 is a perspective view of a carton for multiple individually packaged products showing our design; FIG. 2 is a top plan view thereof; FIG. 3 is a front elevational view thereof; FIG. 4 is a back elevational view thereof; FIG. 5 is a left end elevational view thereof; FIG. 6 is a right end elevational view thereof; and, FIG. 7 is a bottom plan view thereof.

The broken line showing of environment in FIGS. 1 & 2 is for illustrative purposes only and forms no part of the claimed design.

1 Claim, 3 Drawing Sheets

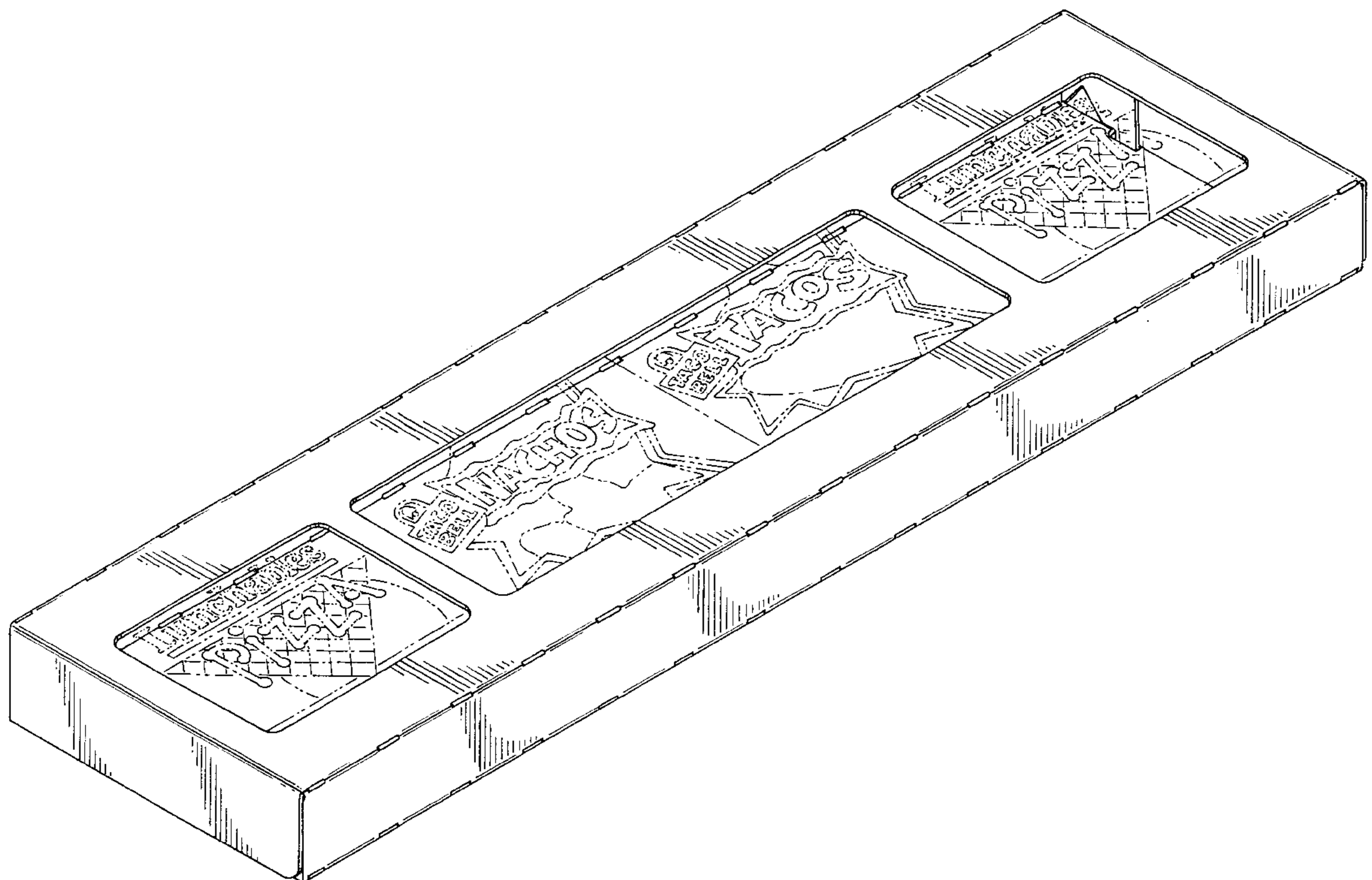

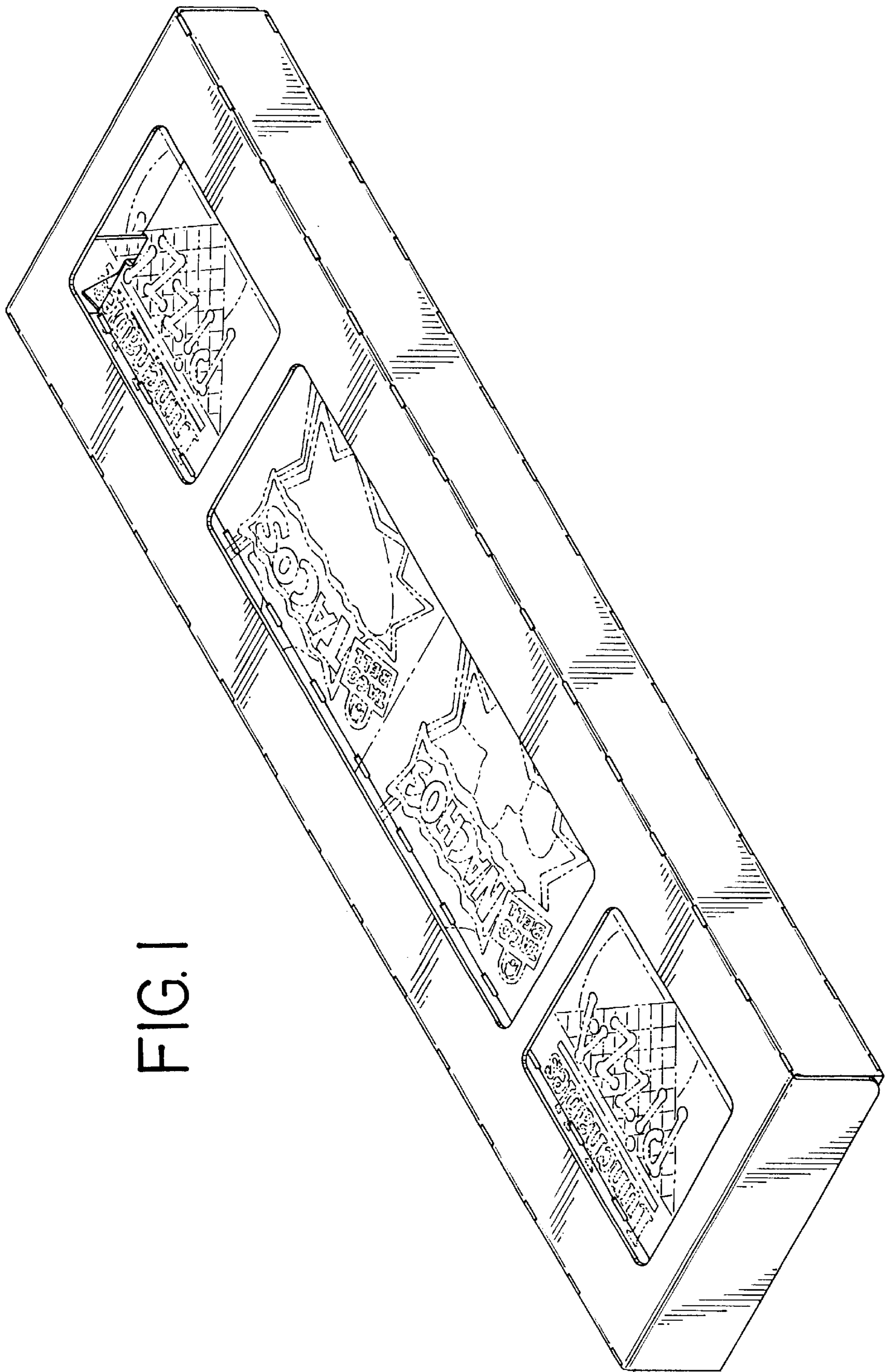

FIG. 1

FIG. 2

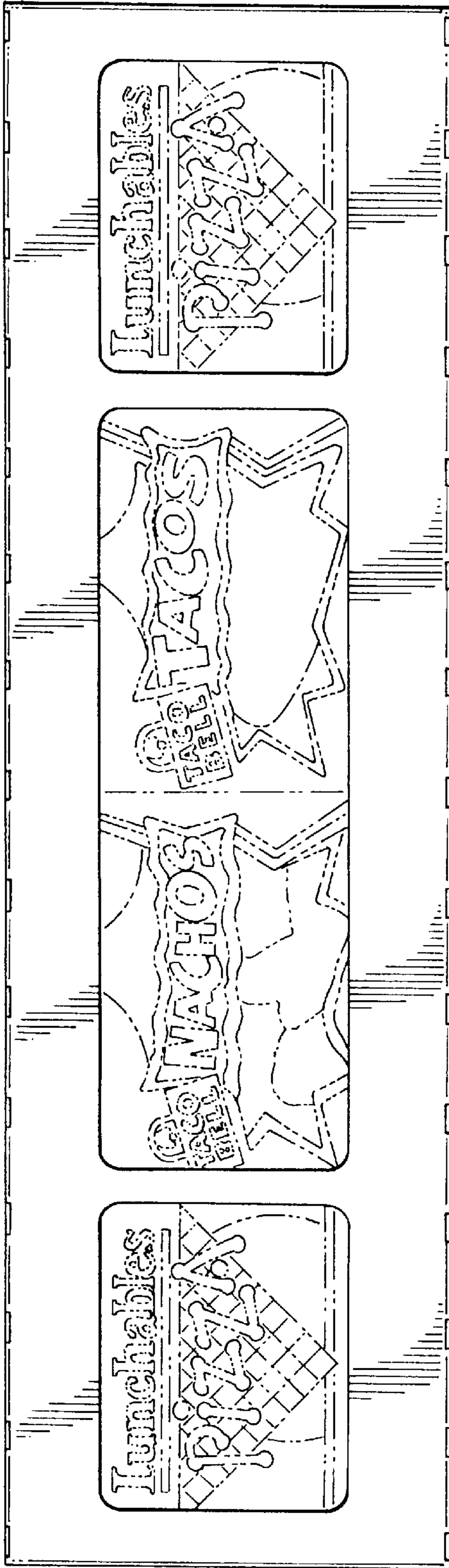

FIG. 3

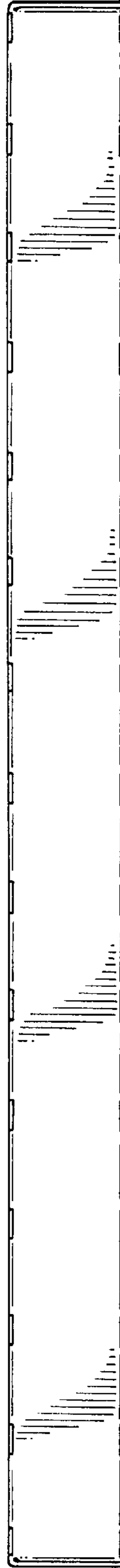

FIG. 4

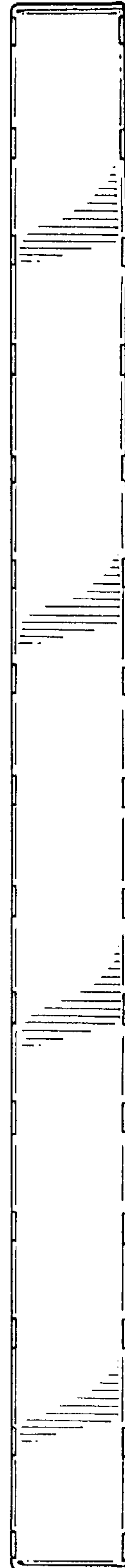

FIG. 6

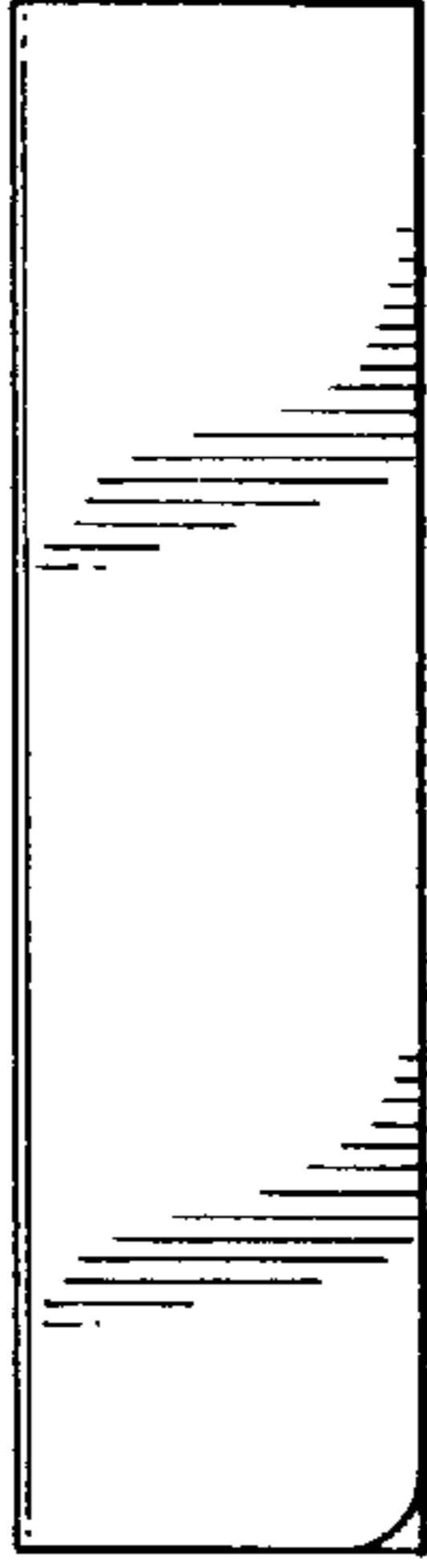

FIG. 5

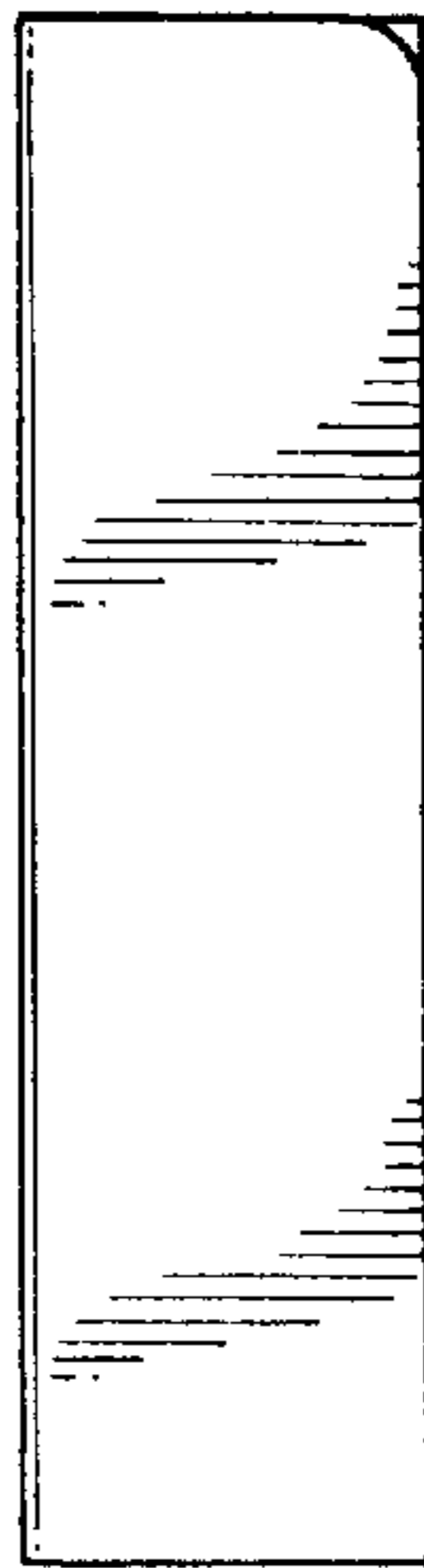

FIG. 7

