



US00D419004S

United States Patent [19] Collins

[11] **Patent Number: Des. 419,004**

[45] **Date of Patent: ** Jan. 18, 2000**

[54] **GARDEN BENCH**

[75] Inventor: **Michael T. Collins**, Brigham City, Utah

[73] Assignee: **Lifetime Products, Inc.**, Clearfield, Utah

[**] Term: **14 Years**

[21] Appl. No.: **29/098,052**

[22] Filed: **Dec. 18, 1998**

[51] **LOC (7) Cl.** **06-06**

[52] **U.S. Cl.** **D6/492**

[58] **Field of Search** D6/334, 335, 336,
D6/369, 370, 373, 379, 381, 492, 495,
500, 501, 502; 297/232, 452.63

[56] **References Cited**

U.S. PATENT DOCUMENTS

D. 46,770	12/1914	Haase	D6/370
D. 74,504	2/1928	Haase	D6/370
D. 266,133	9/1982	Stahl, Jr. et al.	D6/370
D. 273,354	4/1984	Fitts	D6/492
D. 278,776	5/1985	Kime	D6/500
D. 294,782	3/1988	Balderi	D6/373
D. 296,961	8/1988	Norton	D6/370
D. 376,937	12/1996	Skalka	D6/492
D. 383,615	9/1997	Skalka	D6/370

FOREIGN PATENT DOCUMENTS

756188 8/1956 United Kingdom 297/452.63

OTHER PUBLICATIONS

Genham Armchair & Glenham 240cm (8') and 180cm (6') Seats, Sweet's General Building and Renovation, vol. 2, 1993.

Primary Examiner—Doris V. Coles
Assistant Examiner—Mimosa De
Attorney, Agent, or Firm—Madson & Metcalf

[57] **CLAIM**

The ornamental design for a garden bench, as shown and described.

DESCRIPTION

FIG. 1 is a perspective view of a garden bench showing a first preferred embodiment of my new design; FIG. 2 is a right side elevational view of the embodiment of FIG. 1; FIG. 3 is a left side elevational view of the embodiment of FIG. 1; FIG. 4 is a front elevational view of the embodiment of FIG. 1; FIG. 5 is a rear elevational view of the embodiment of FIG. 1; FIG. 6 is a top plan view of the embodiment of FIG. 1; FIG. 7 is a bottom plan view of the embodiment of FIG. 1; FIG. 8 is a perspective view of a garden bench showing a second preferred embodiment of my design; FIG. 9 is a right side elevational view of the embodiment of FIG. 8; FIG. 10 is a left side elevational view of the embodiment of FIG. 8; FIG. 11 is a front elevational view of the embodiment of FIG. 8; FIG. 12 is a rear elevational view of the embodiment of FIG. 8; FIG. 13 is a top plan view of the embodiment of FIG. 8; and, FIG. 14 is a bottom plan view of the embodiment of FIG. 8. The broken line showing of the bench is for illustrative purposes only and forms no part of the claimed design.

1 Claim, 8 Drawing Sheets

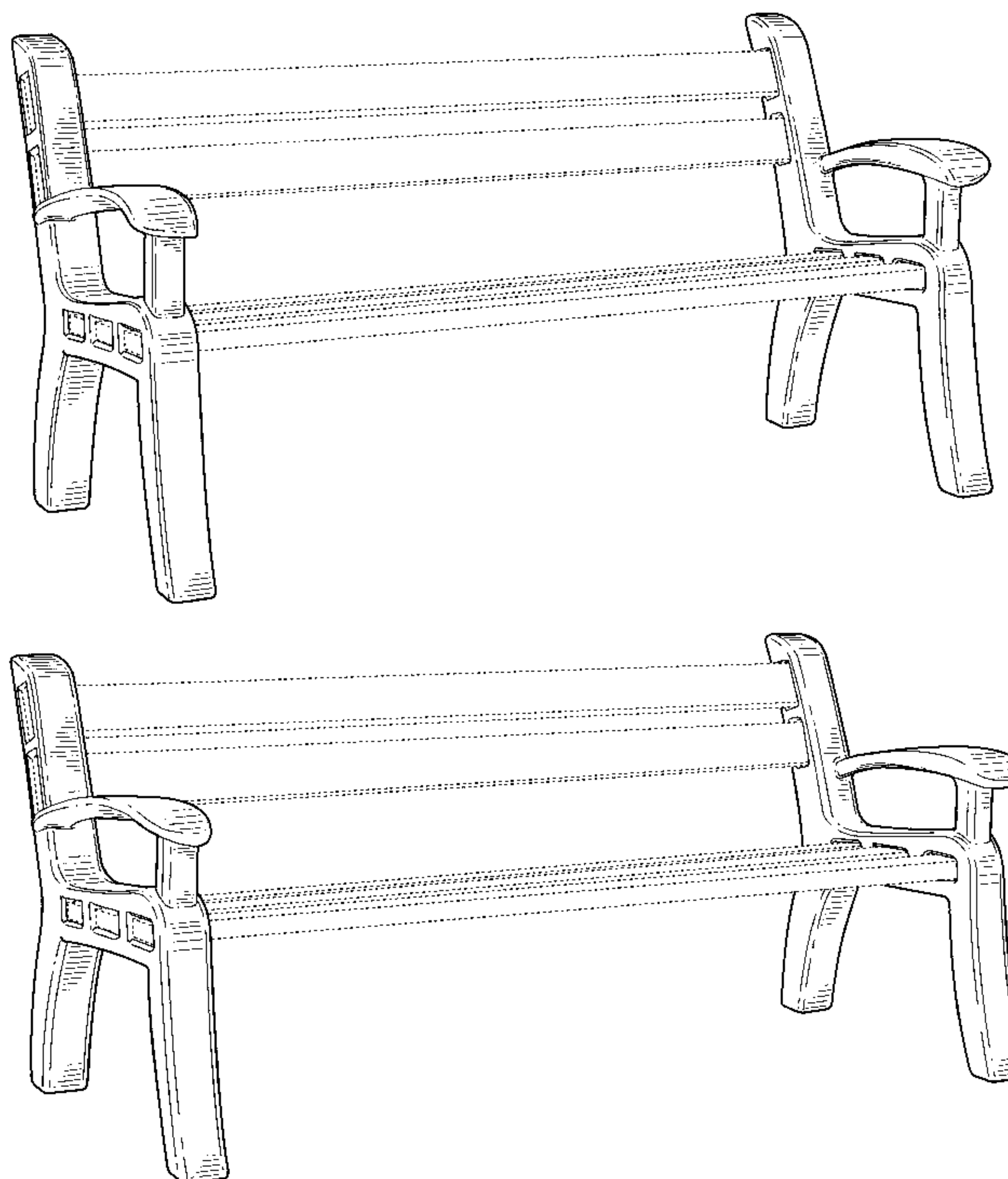

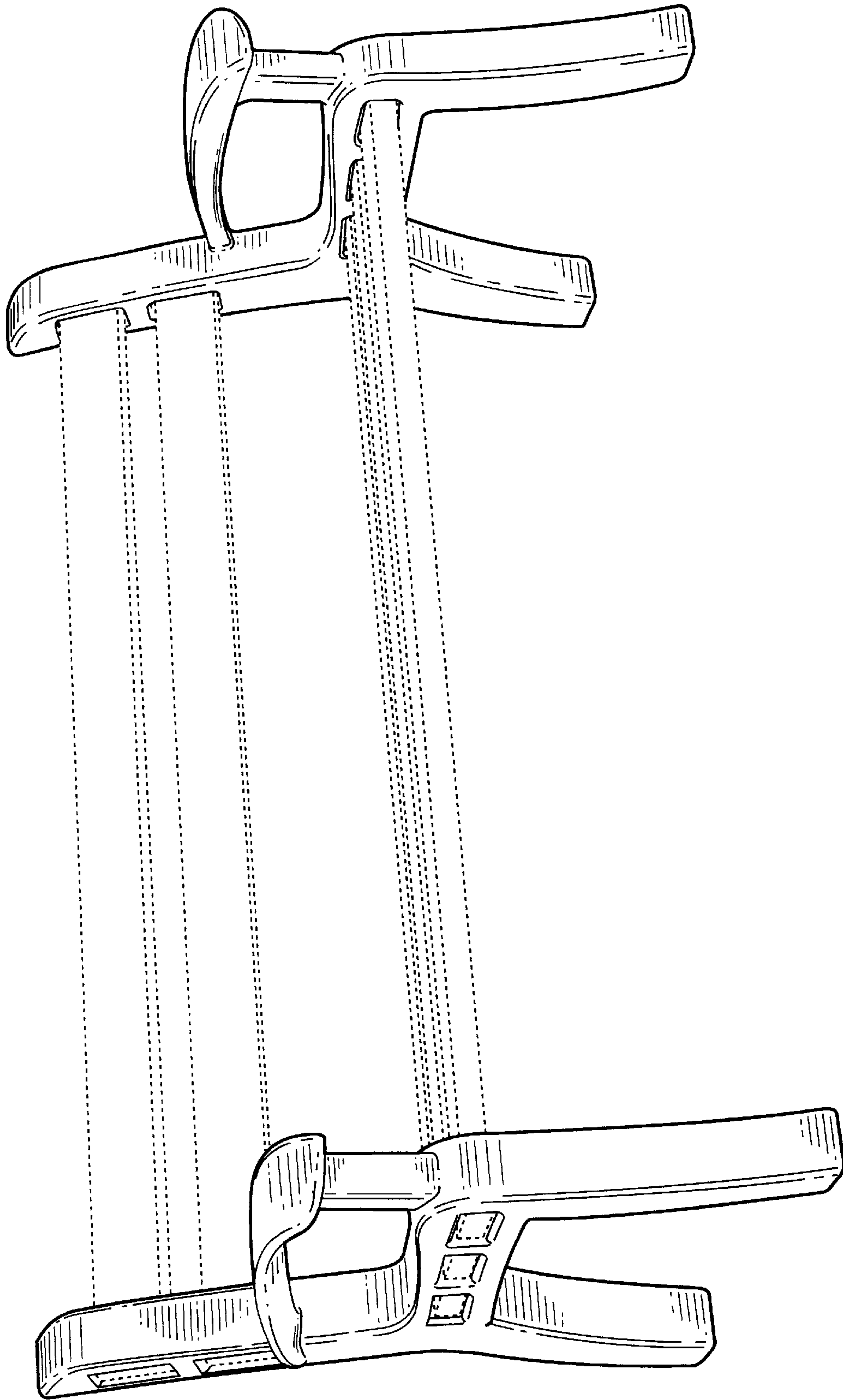

Fig. 1

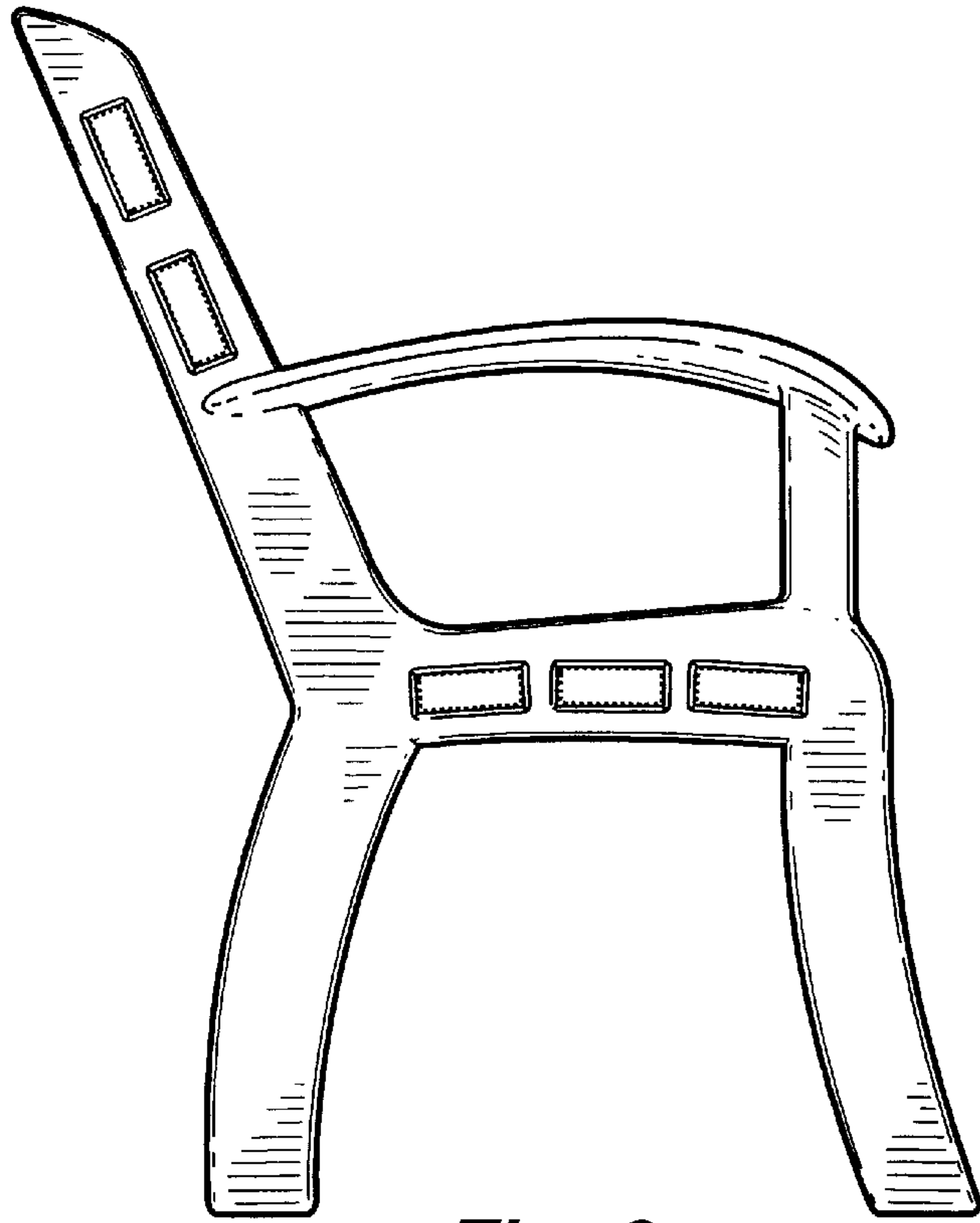

Fig. 2

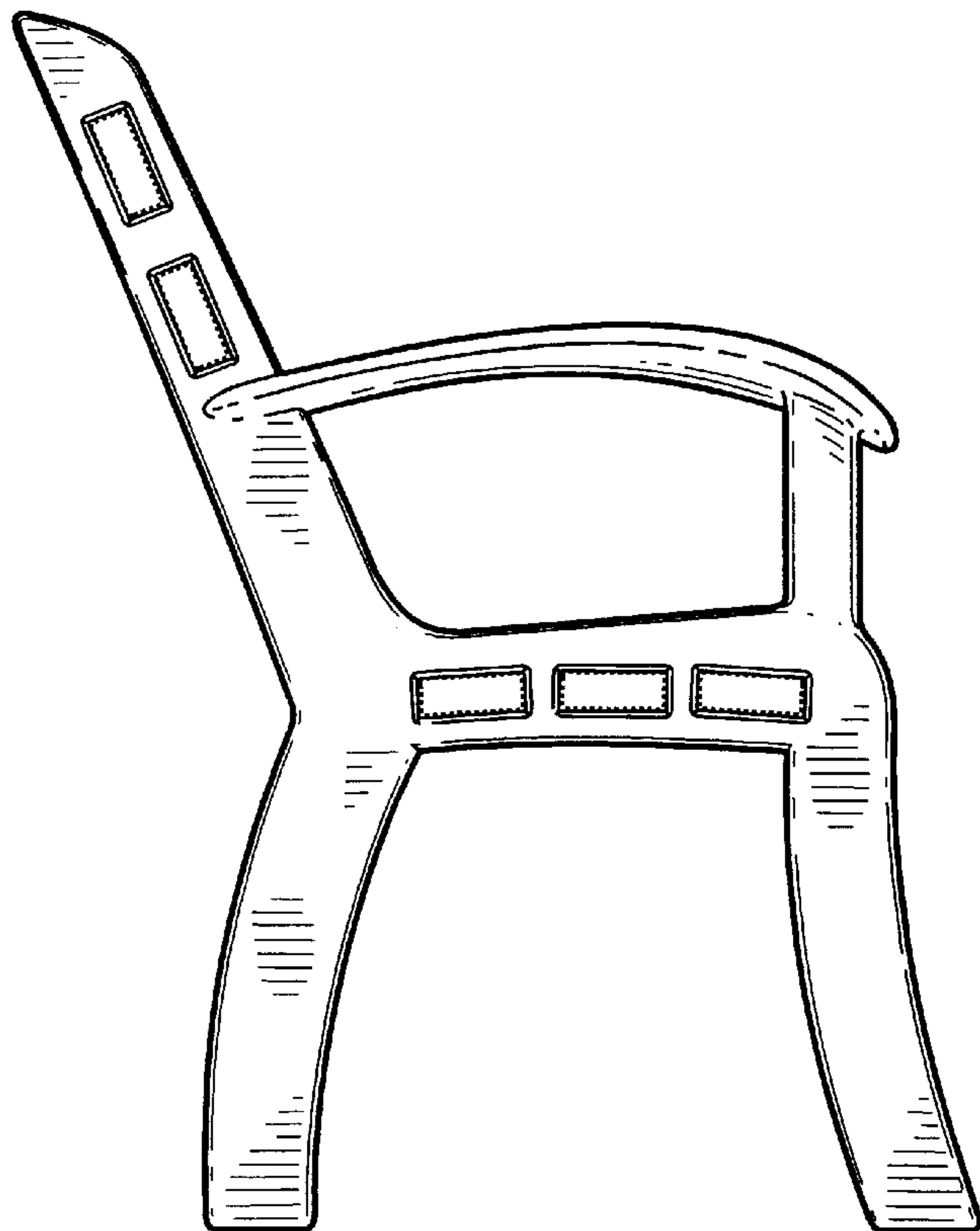

Fig. 3

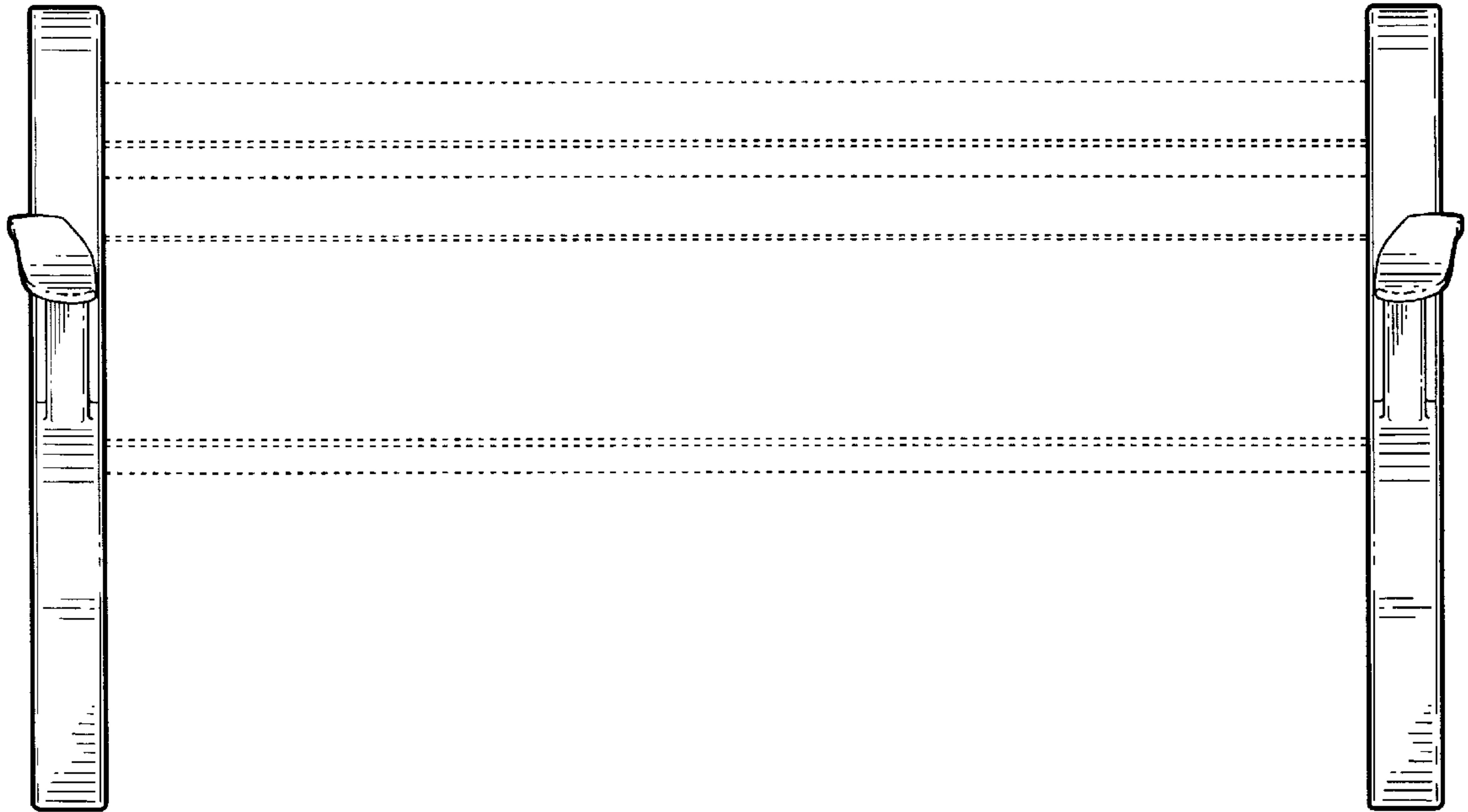

Fig. 4

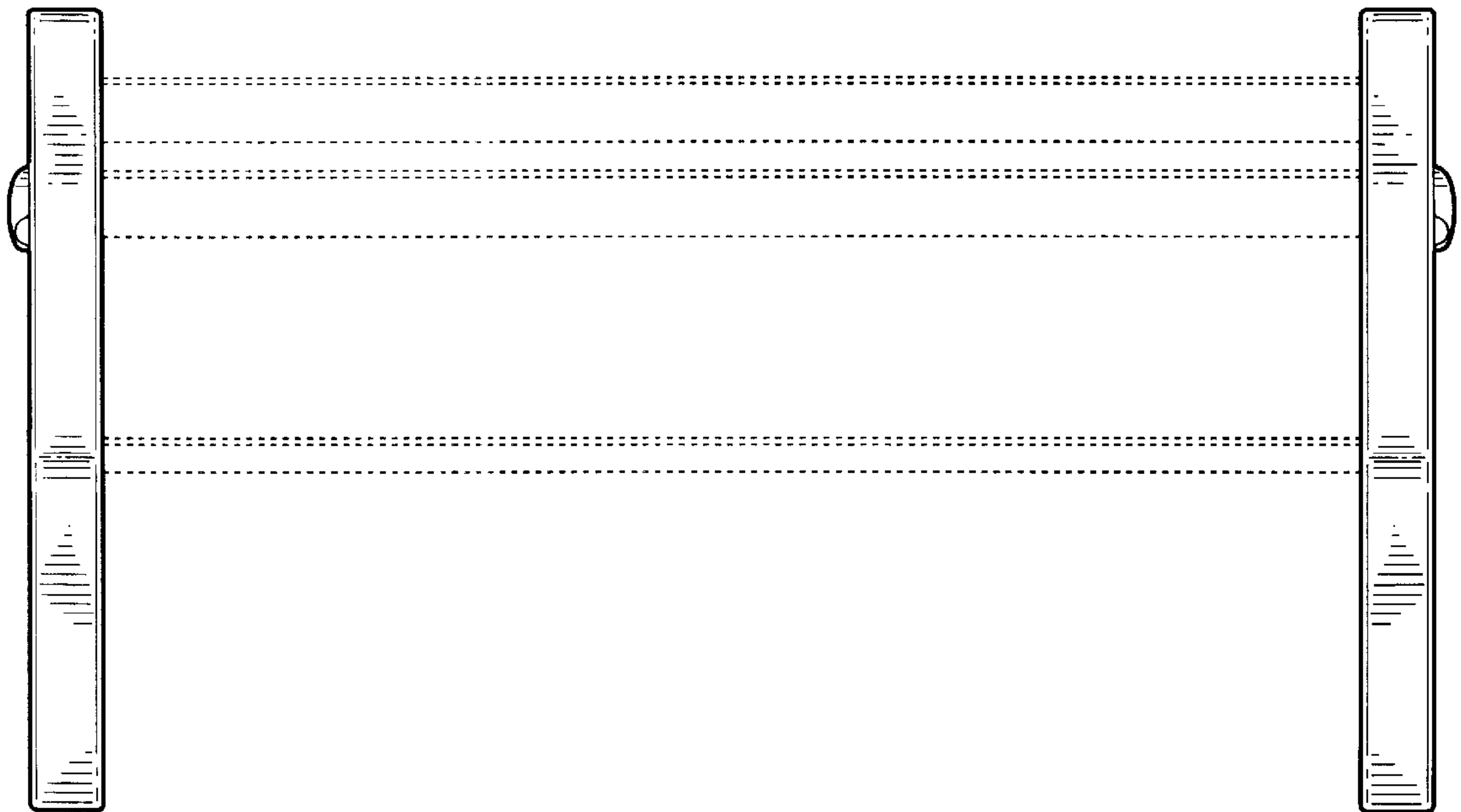

Fig. 5

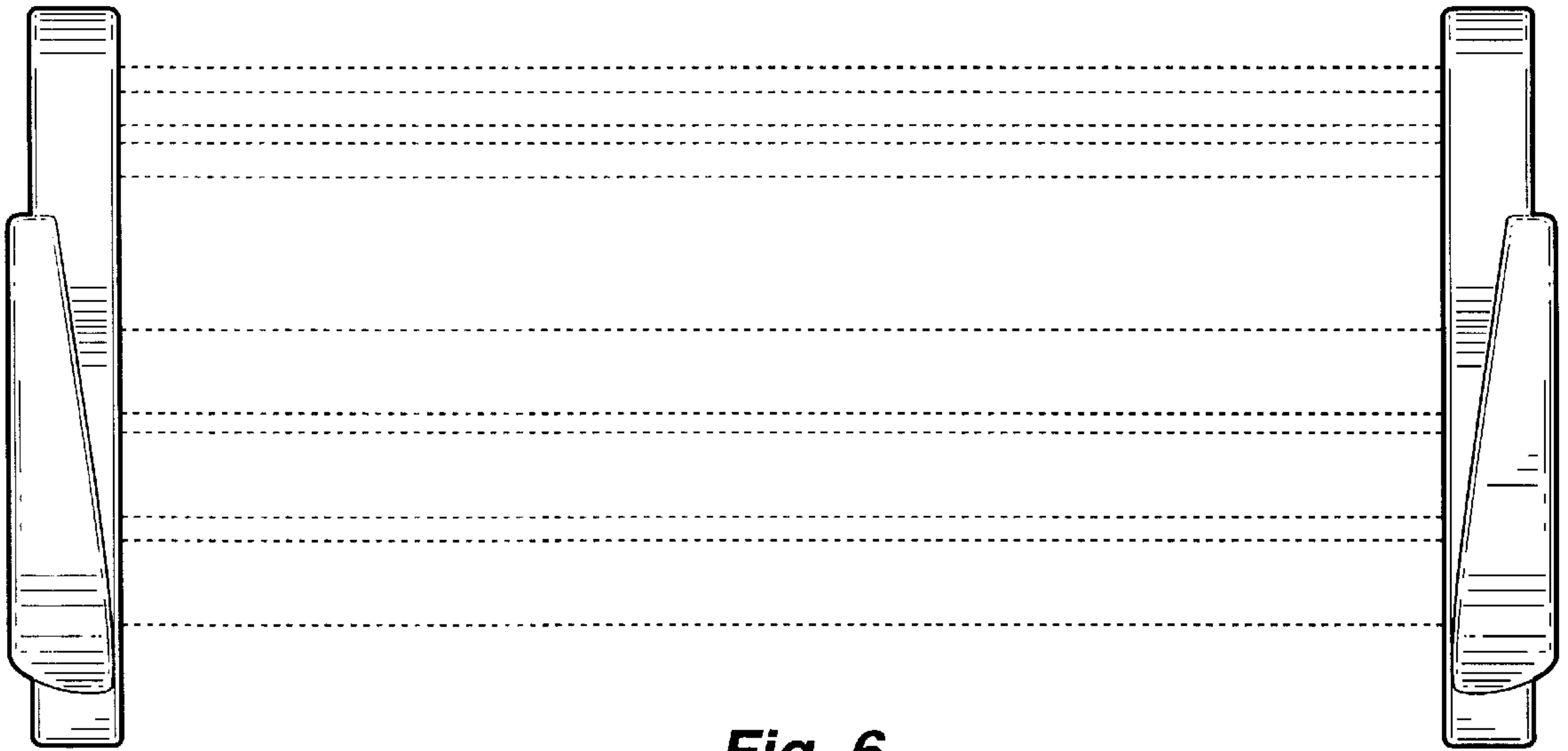

Fig. 6



Fig. 7

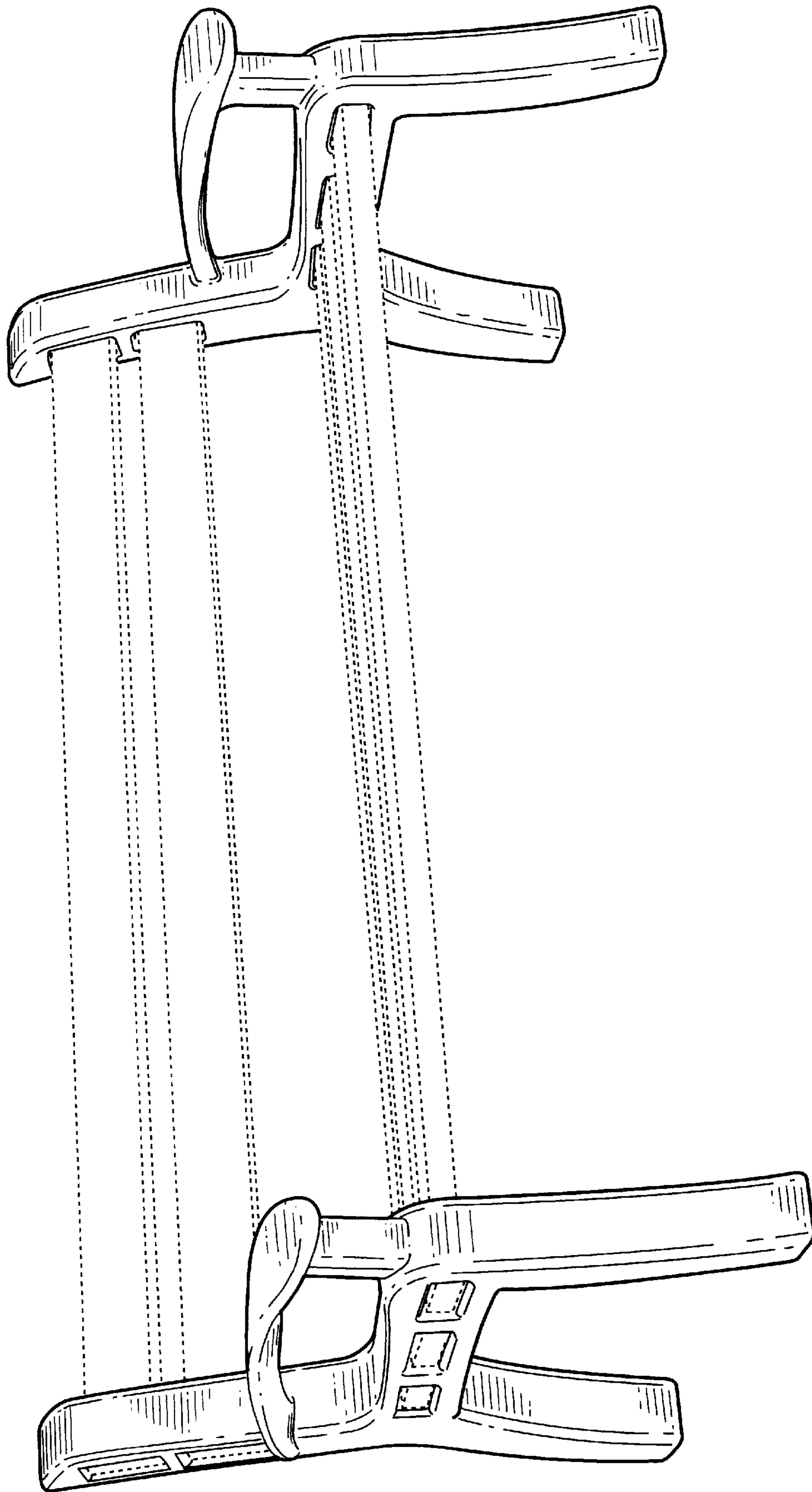

Fig. 8

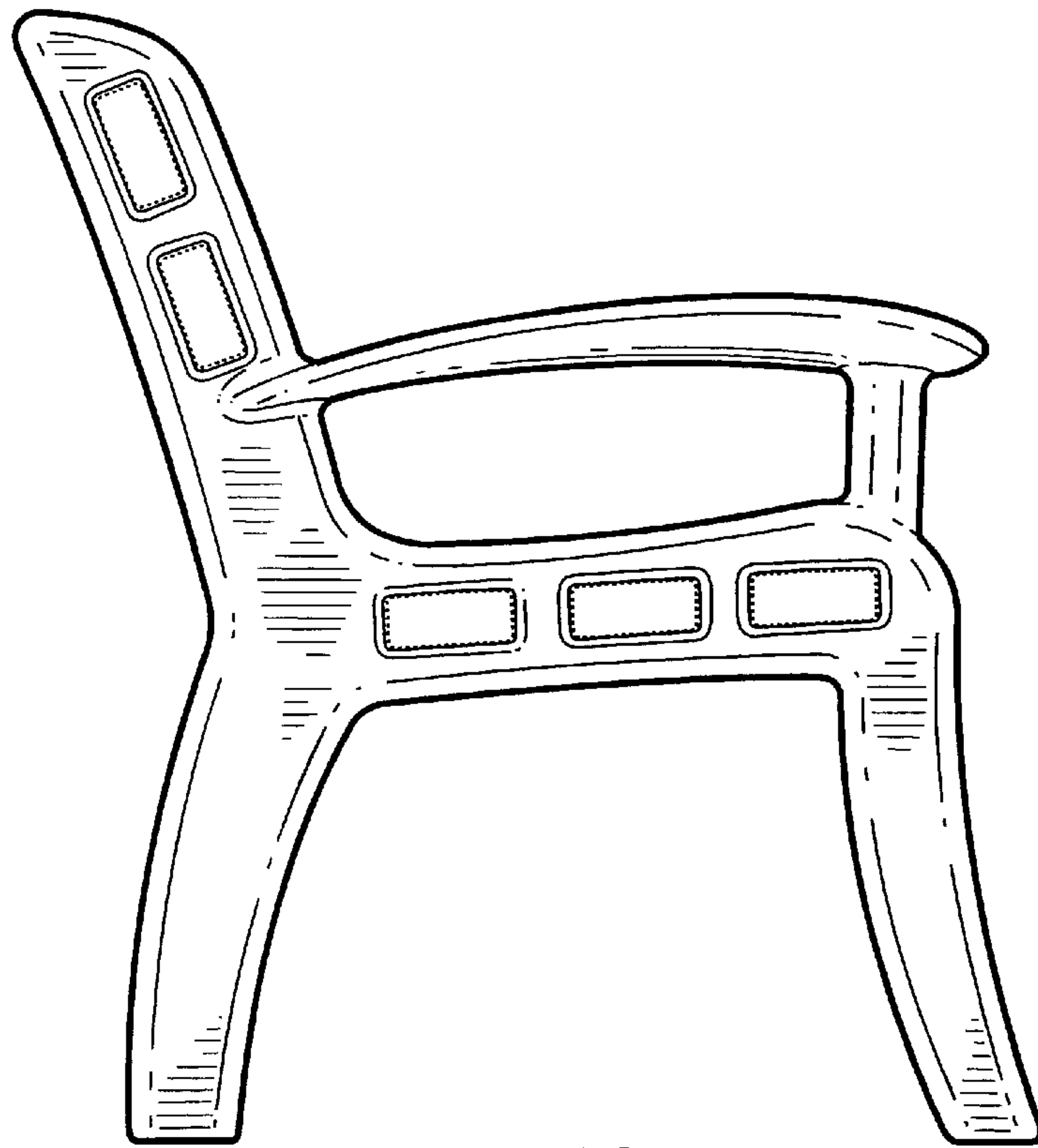

Fig. 9

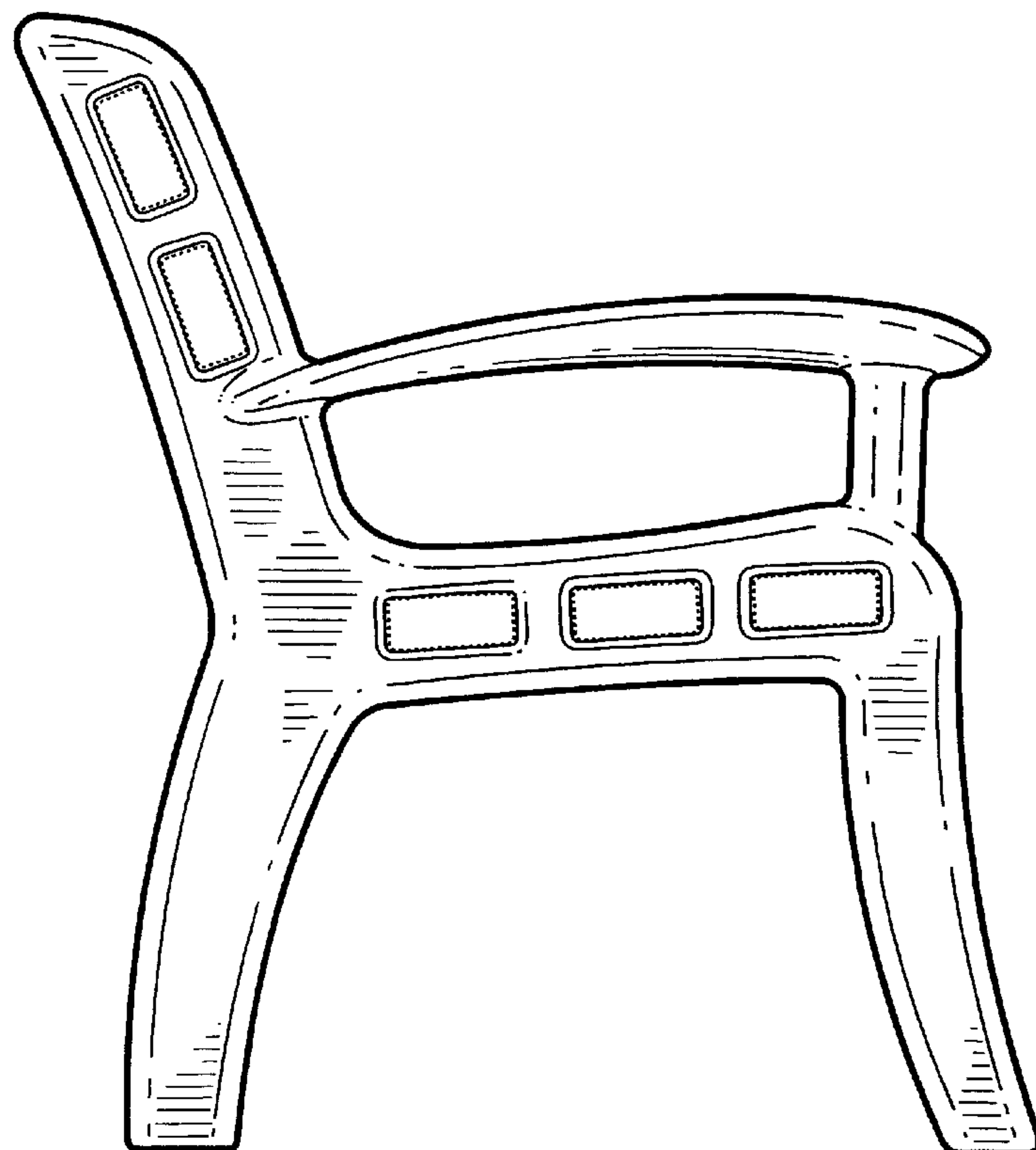

Fig. 10

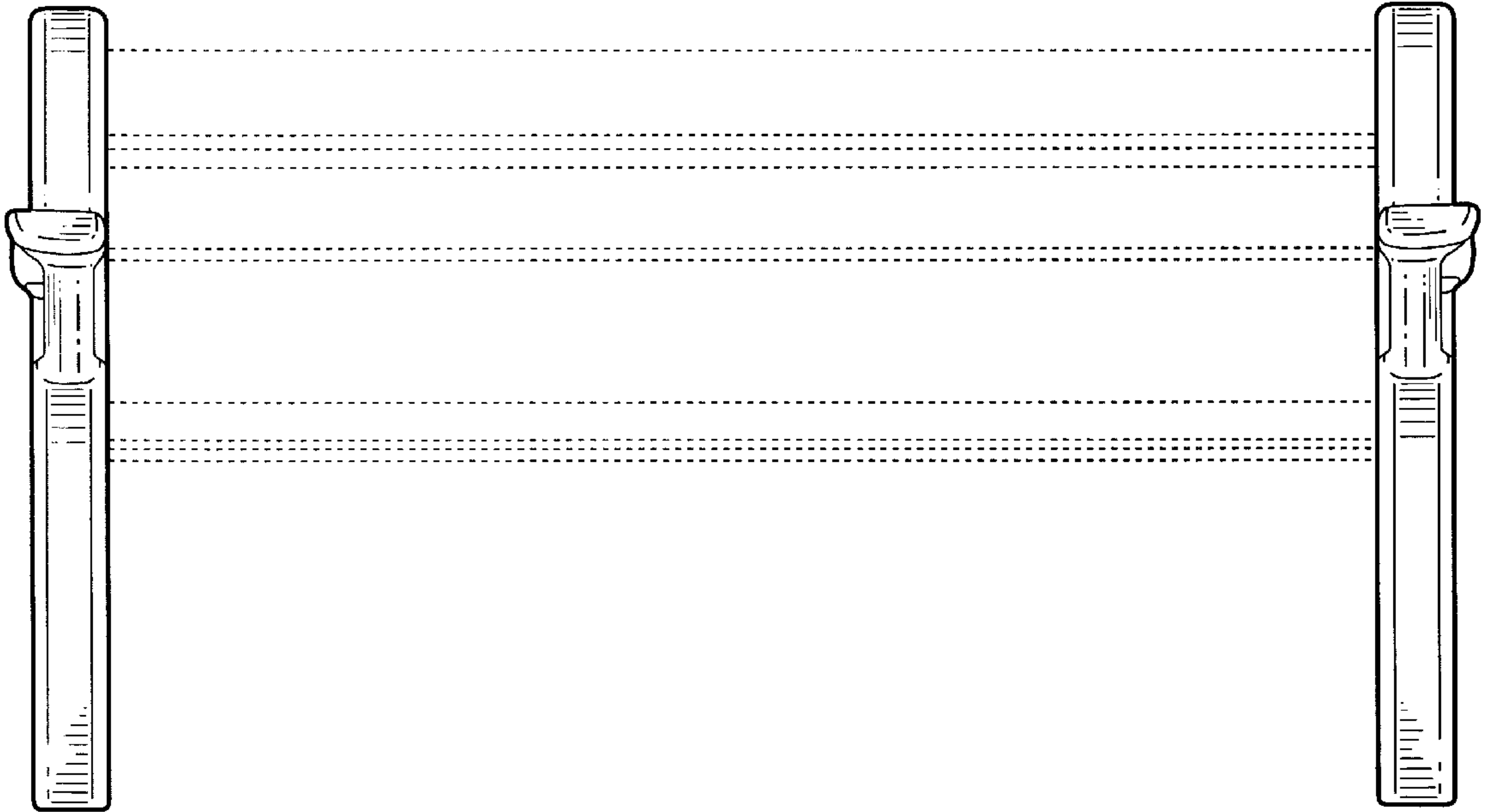

Fig. 11

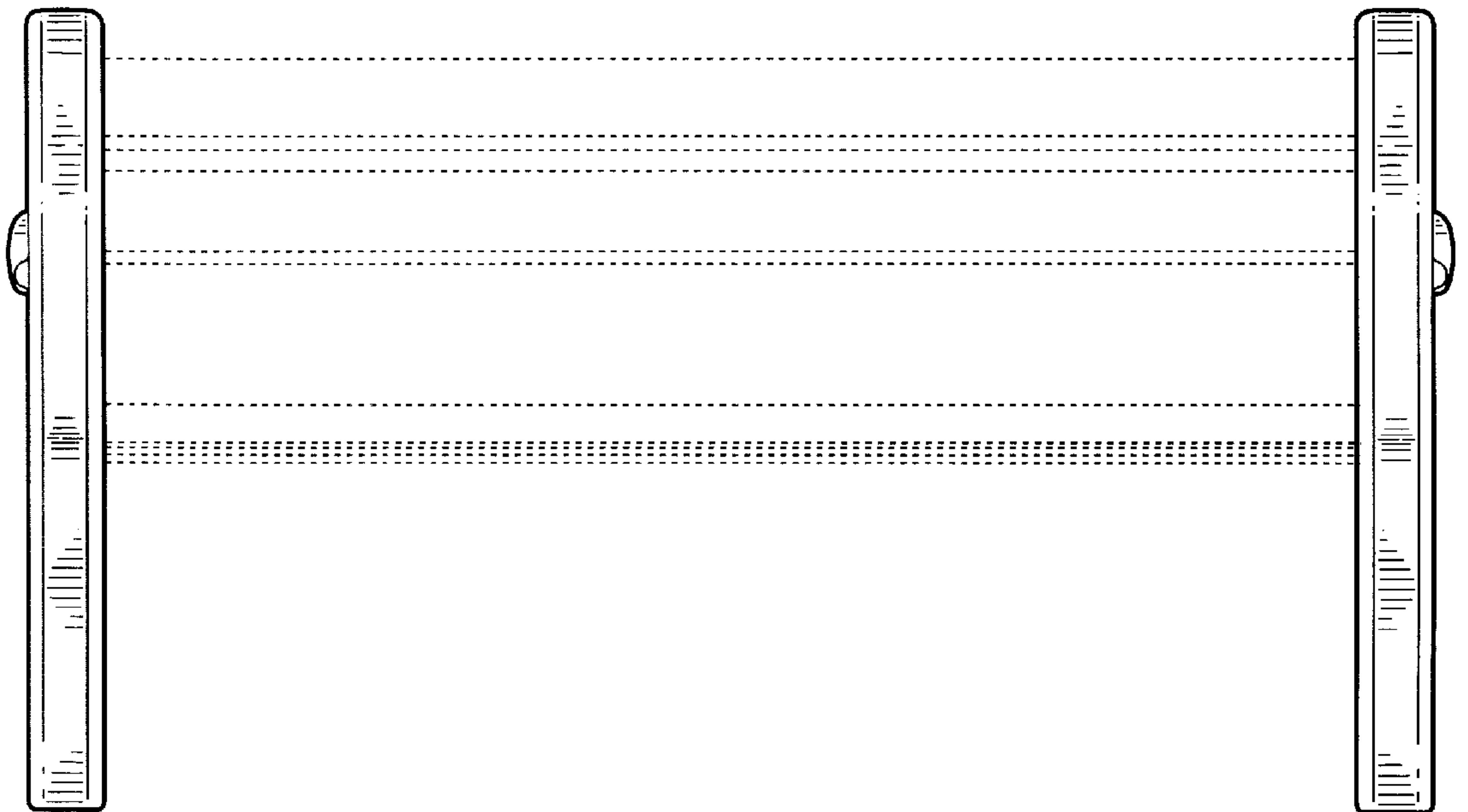

Fig. 12

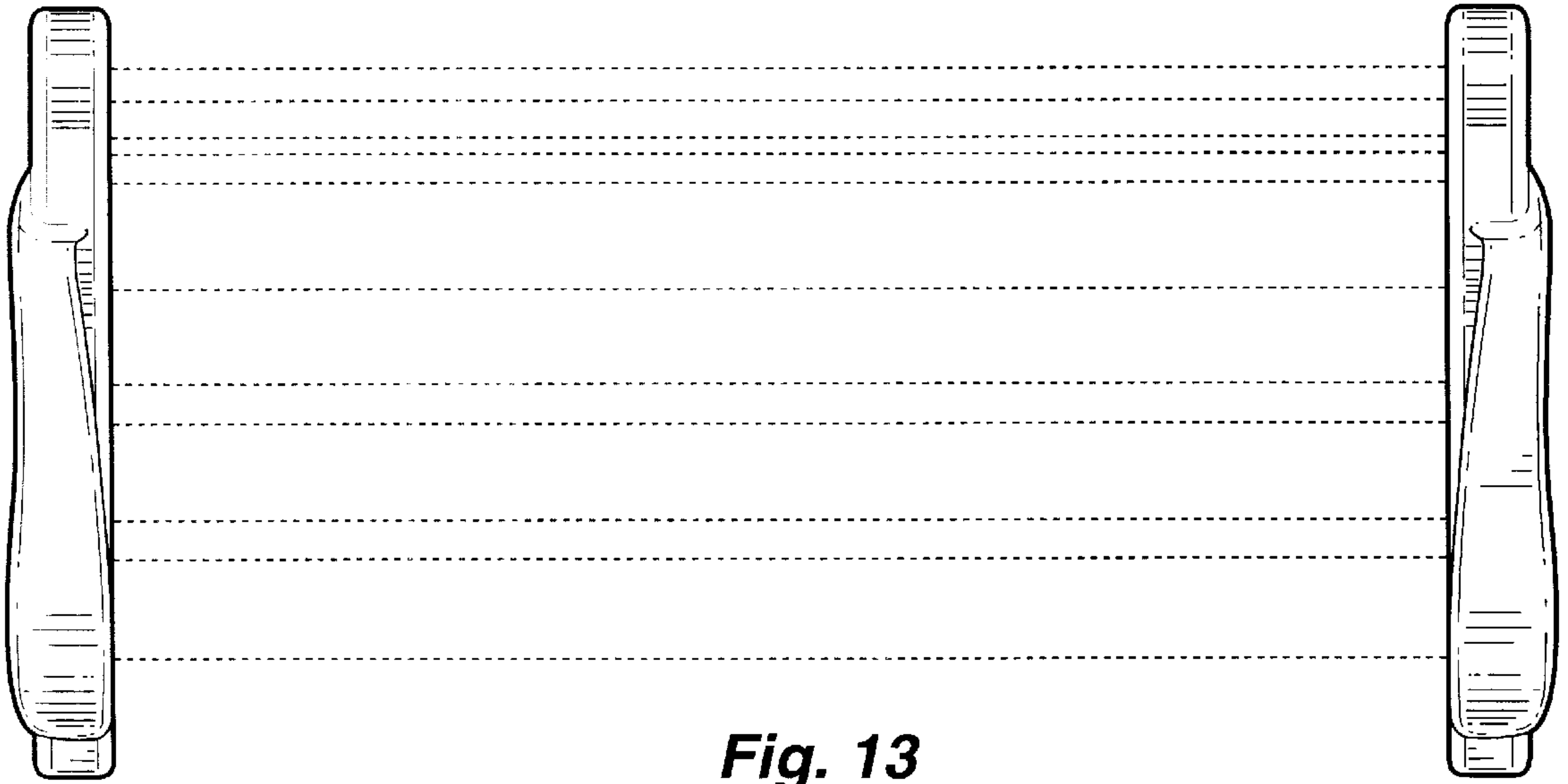

Fig. 13

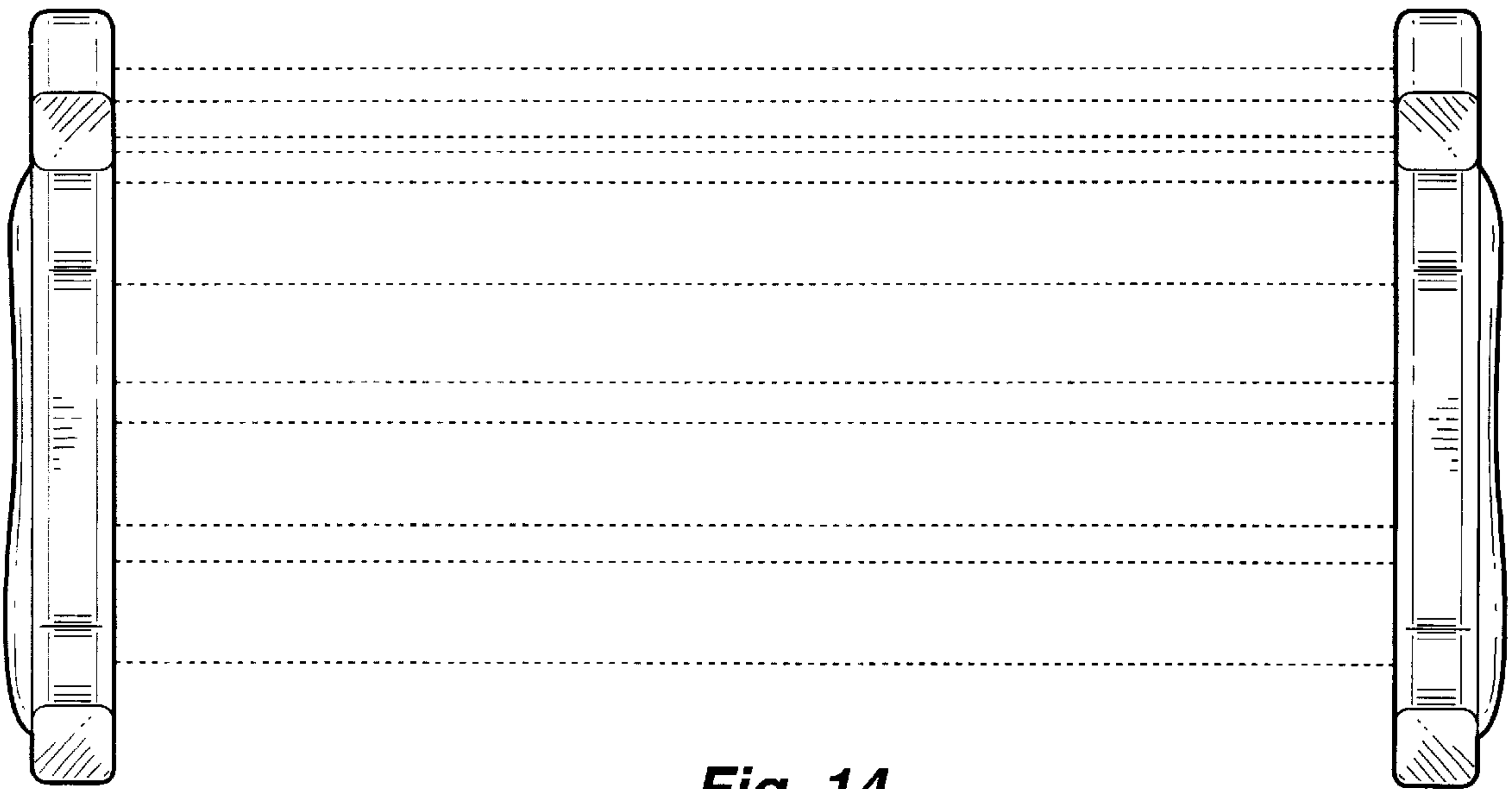

Fig. 14