



US00D418993S

United States Patent [19]

[11] Patent Number: **Des. 418,993**

Natuzzi et al.

[45] Date of Patent: **** Jan. 18, 2000**

[54] SEAT

[75] Inventors: **Pasquale Natuzzi; Domenico Abbruzzese**, both of Bari, Italy

[73] Assignee: **Industrie Natuzzi, SPA**, Bari, Italy

[**] Term: **14 Years**

[21] Appl. No.: **29/102,258**

[22] Filed: **Mar. 19, 1999**

[51] **LOC (7) Cl.** **06-01**

[52] **U.S. Cl.** **D6/381; D6/334**

[58] **Field of Search** D6/334, 335, 336, D6/364, 371, 373, 381, 500, 501, 502; 297/232, 445.1

[56] References Cited

U.S. PATENT DOCUMENTS

D. 381,829	8/1997	Natuzzi et al.	D6/381
D. 386,623	11/1997	Natuzzi et al.	D6/381
D. 388,259	12/1997	Natuzzi et al.	D6/381
D. 388,971	1/1998	Natuzzi et al.	D6/381
D. 389,331	1/1998	Natuzzi et al.	D6/381
D. 393,759	4/1998	Natuzzi et al.	D6/381
D. 405,287	2/1999	Watson	D6/381
D. 407,574	4/1999	Natuzzi et al.	D6/381
D. 410,344	6/1999	Lewis et al.	D6/381

OTHER PUBLICATIONS

Natuzzi Model 197, Oct. 1987, at International Home Furnishings Market in High Point, North Carolina.
 Natuzzi Model 412, Oct. 1987, at International Home Furnishings Market in High Point, North Carolina.
 Natuzzi Model 722, Oct. 1989, at International Home Furnishings Market in High Point, North Carolina.
 Natuzzi Model 763, Apr. 1990, at International Home Furnishings Market in High Point, North Carolina.
 Natuzzi Model 764, Apr. 1990, at International Home Furnishings Market in High Point, North Carolina.
 Natuzzi Model 769, Oct. 1990, at International Home Furnishings Market in High Point, North Carolina.
 Natuzzi Model 917, Apr. 1992, at International Home Furnishings Market in High Point, North Carolina.

Natuzzi Model 949, Oct. 1992, at International Home Furnishing Market in High Point, North Carolina.
 Natuzzi Model 1086, Sep. 1993, at International Home Furnishings Market in High Point, North Carolina.
 Natuzzi Model 1096, Sep. 1993, at International Home Furnishings Market in High Point, North Carolina.
 Natuzzi Model 1130, Jan. 1994, at International Home Furnishings Market in High Point, North Carolina.
 Natuzzi Model 1136, Apr. 1994, at International Home Furnishings Market in High Point, North Carolina.
 Natuzzi Model 1182, Sep. 1993, at International Home Furnishings Market in High Point, North Carolina.
 Natuzzi Model 1222, Oct. 1994, at International Home Furnishings Market in High Point, North Carolina.
 Natuzzi Model 1264, Apr. 1994, at International Home Furnishings Market in High Point, North Carolina.
 Natuzzi Model 1369, Oct. 1995, at International Home Furnishings Market in High Point, North Carolina.
 Natuzzi Model 1454, Apr. 1996, at International Home Furnishings Market in High Point, North Carolina.
 Natuzzi Model 1563, Apr. 1997, at International Home Furnishing Market in High Point, North Carolina.
 Natuzzi Model 1643, Oct. 1997, at International Home Furnishings Market in High Point, North Carolina.

Primary Examiner—Gary D. Watson
Attorney, Agent, or Firm—Alston & Bird LLP

[57] CLAIM

The ornamental design for a seat, as shown and described.

DESCRIPTION

FIG. 1 is a front perspective view of a seat showing our new design in the form of a sofa;
 FIG. 2 is a front elevational view thereof;
 FIG. 3 is a top plan view thereof;
 FIG. 4 is a right side elevational view, the left side being a mirror image thereof;
 FIG. 5 is a rear perspective view thereof;
 FIG. 6 is a front elevational view of a seat showing our new design in the form of a loveseat; and,
 FIG. 7 is a front elevational view of a seat showing our new design in the form of a chair.

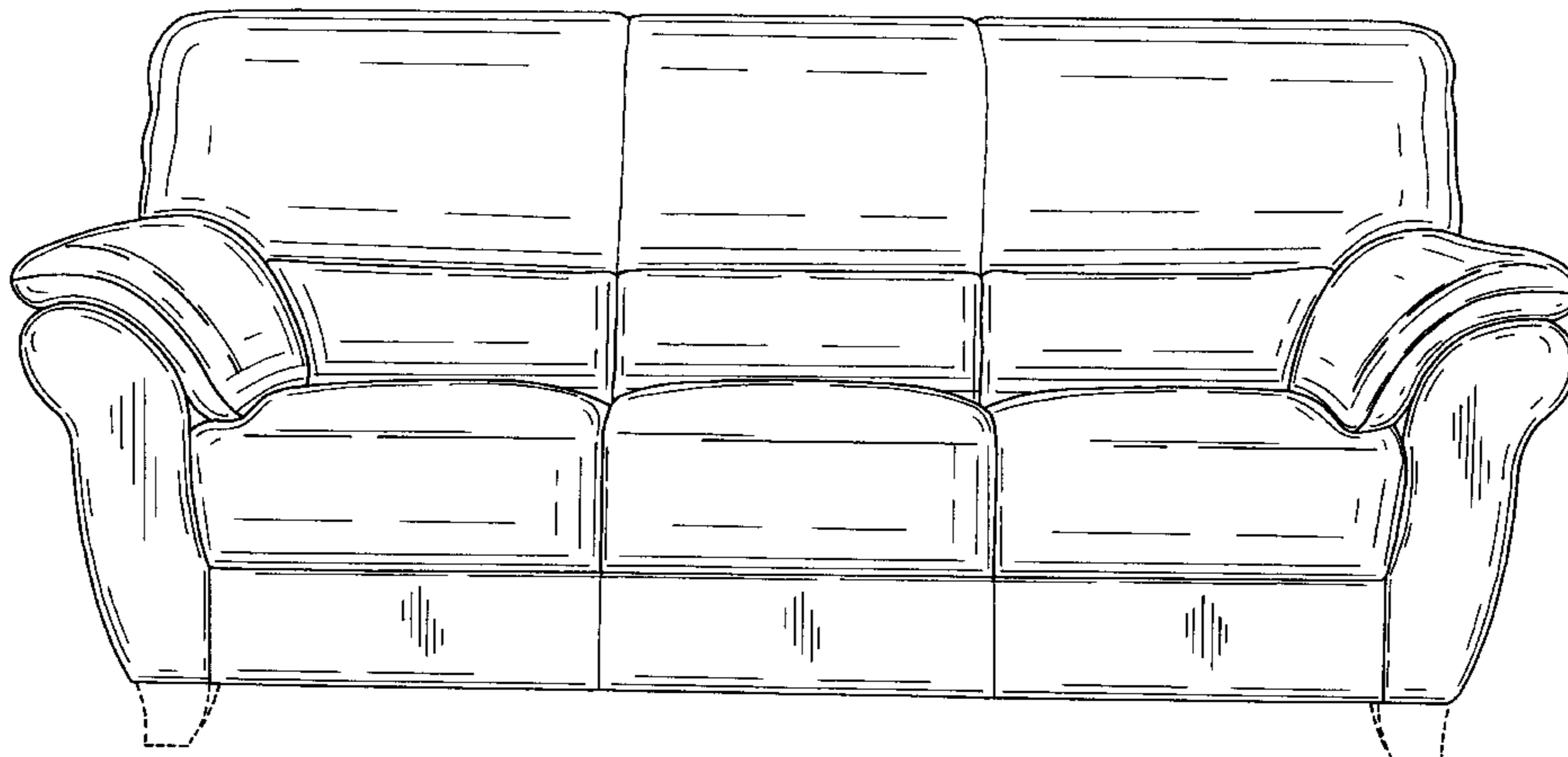

Des. 418,993

Page 2

The broken lines shown herein are for illustrative purposes only and form no part of the claimed design.

The rear views of FIGS. 6 and 7 are like FIG. 5, the difference being a matter of length.

The end views of FIGS. 6 and 7 are like FIG. 4.

FIGS. 1 and 5 are shown on an enlarged scale with respect to the other views.

1 Claim, 3 Drawing Sheets

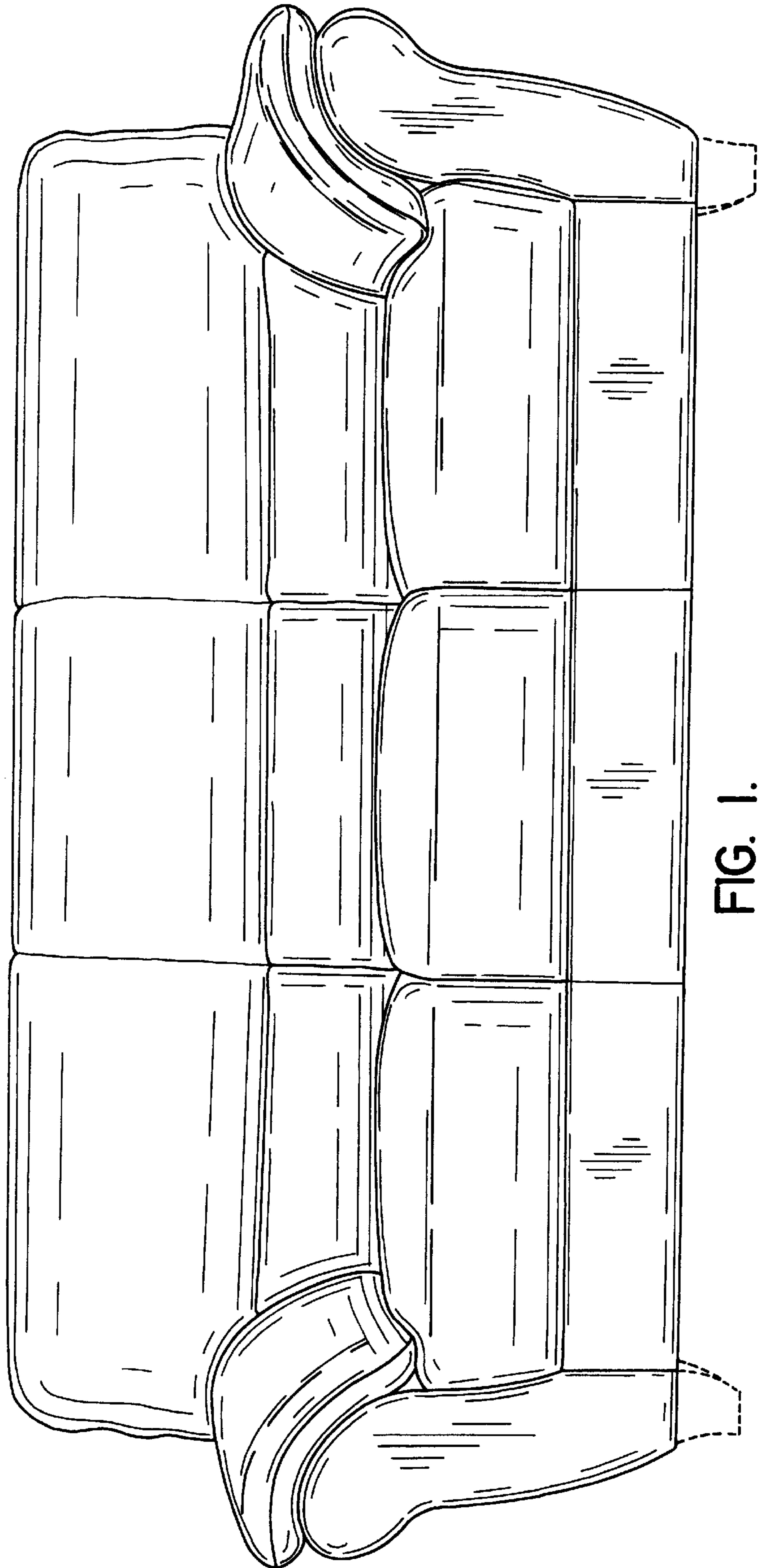

FIG. 1.

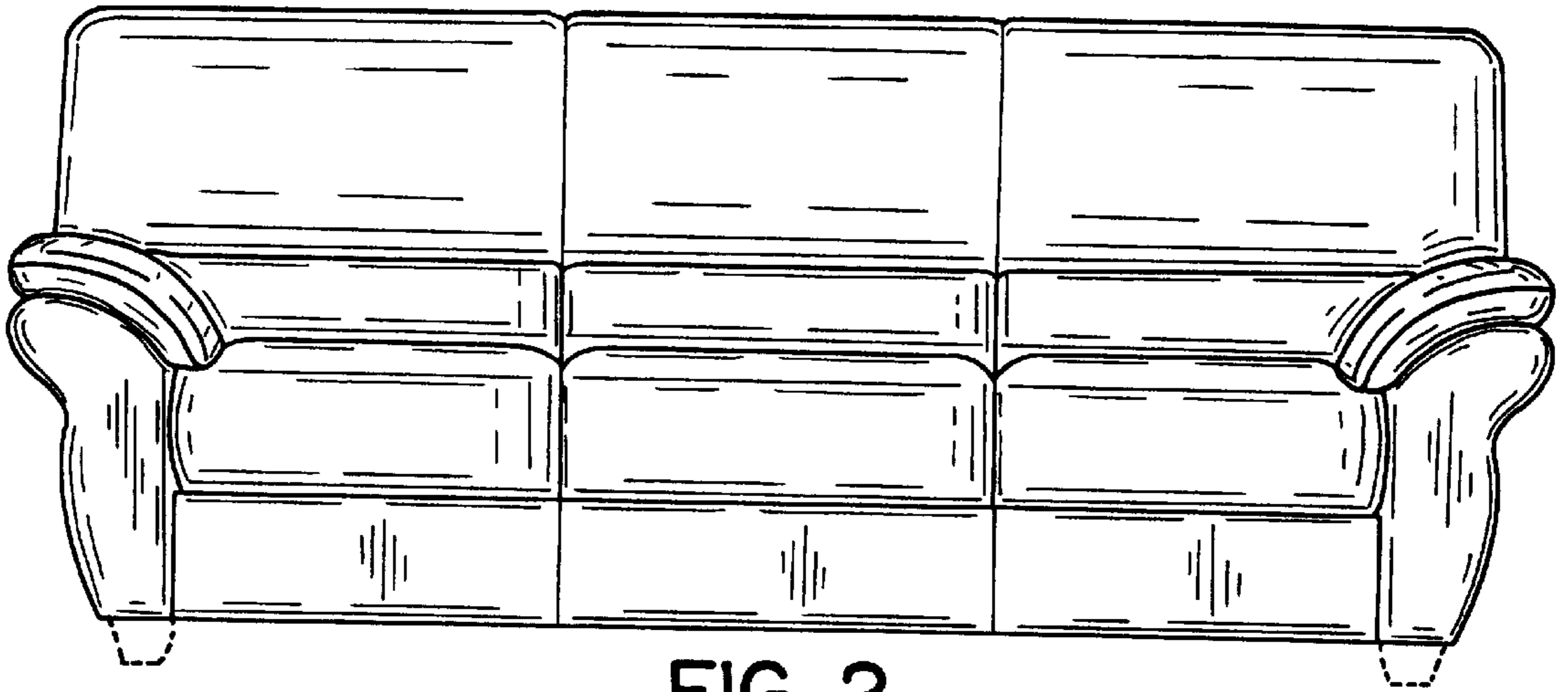

FIG. 2.



FIG. 3.

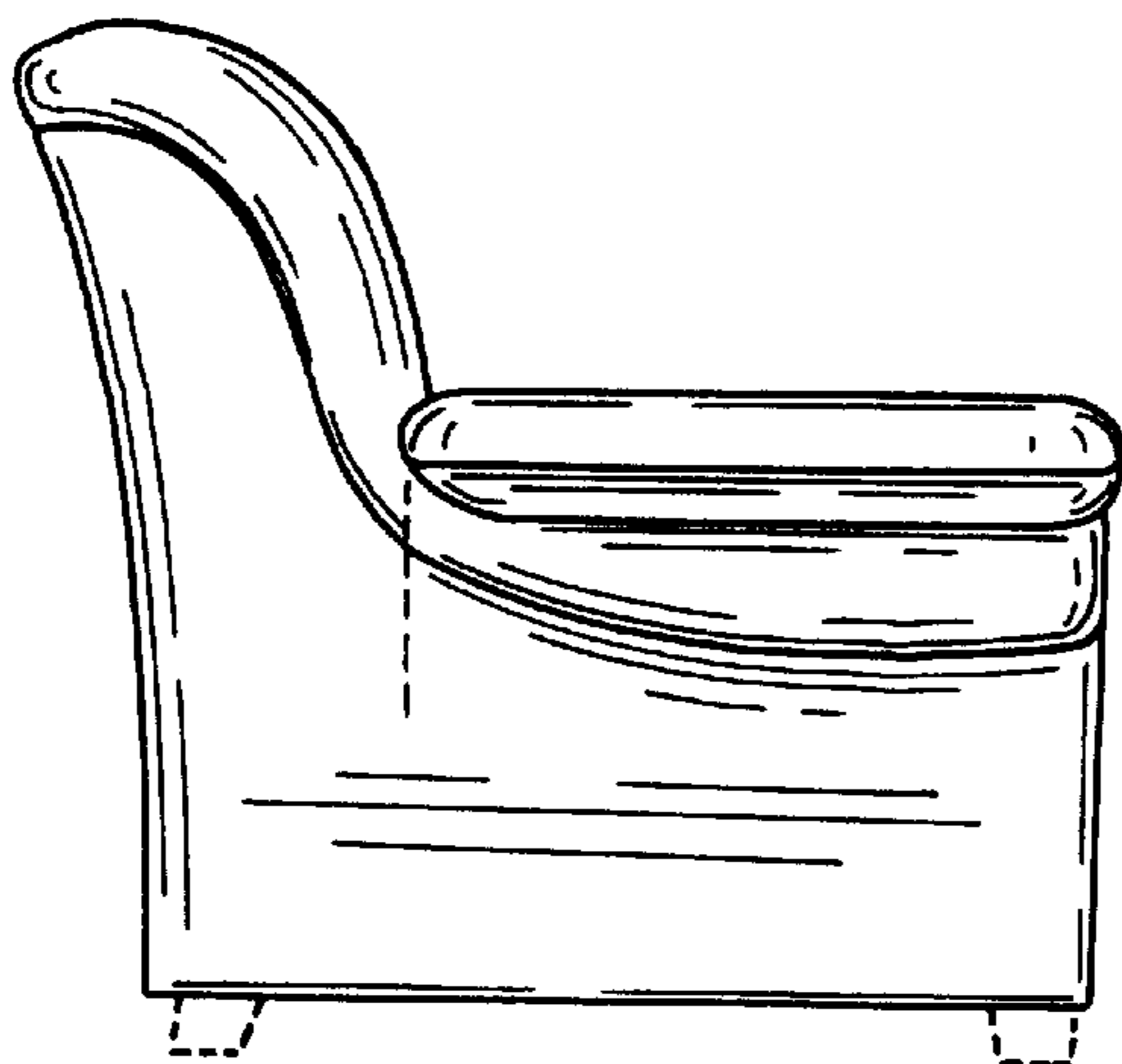

FIG. 4.

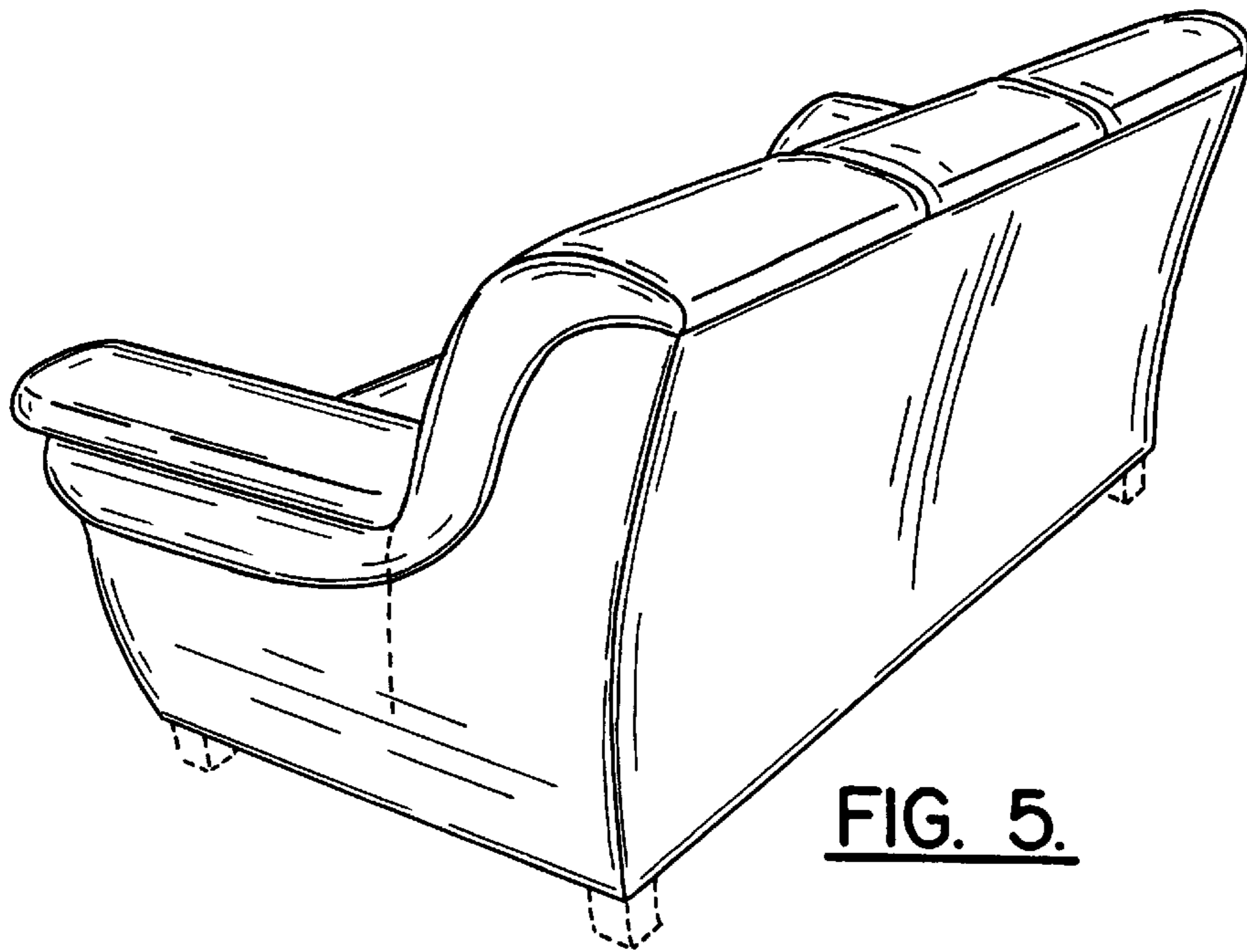

FIG. 5.

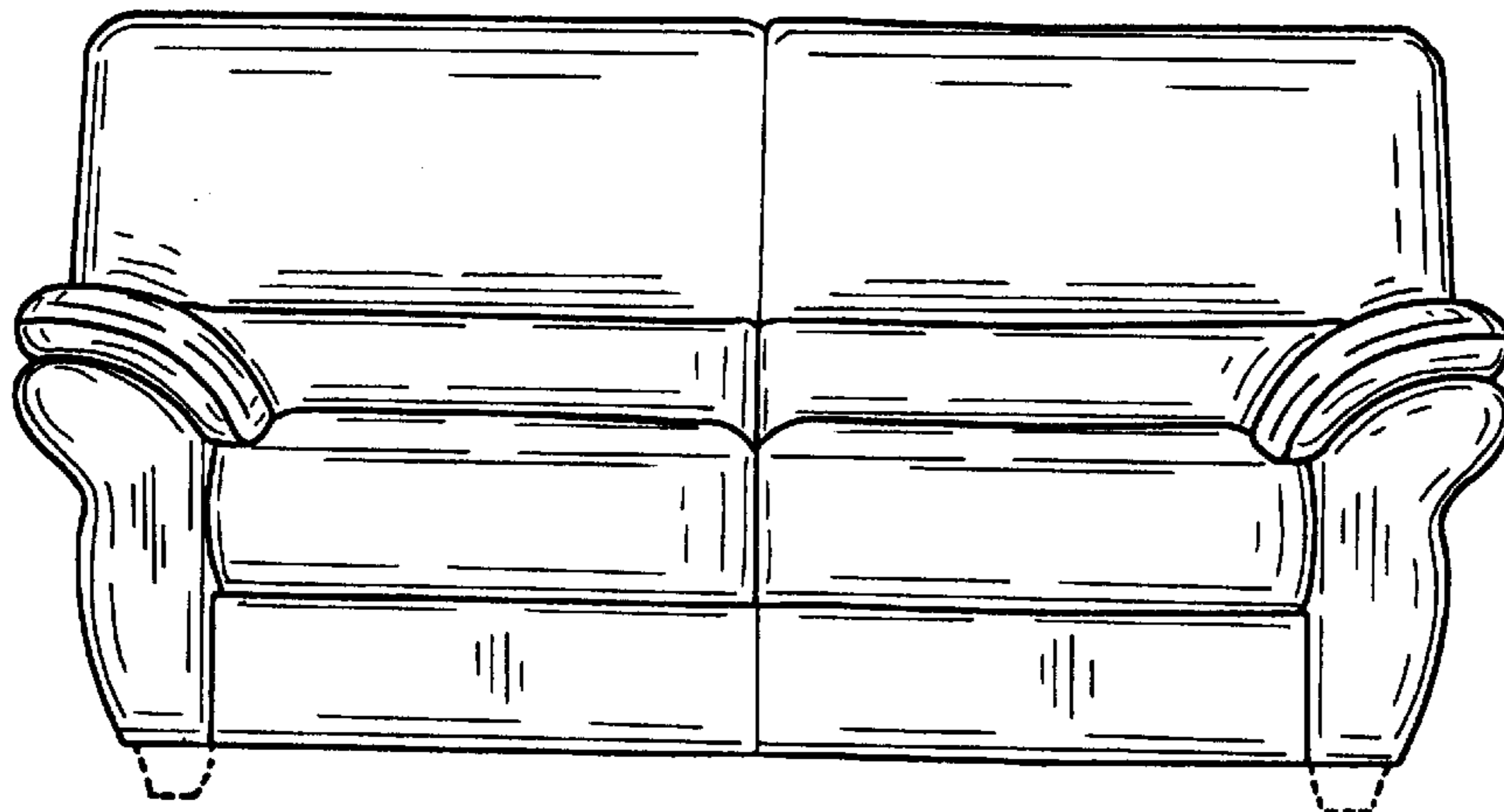

FIG. 6.

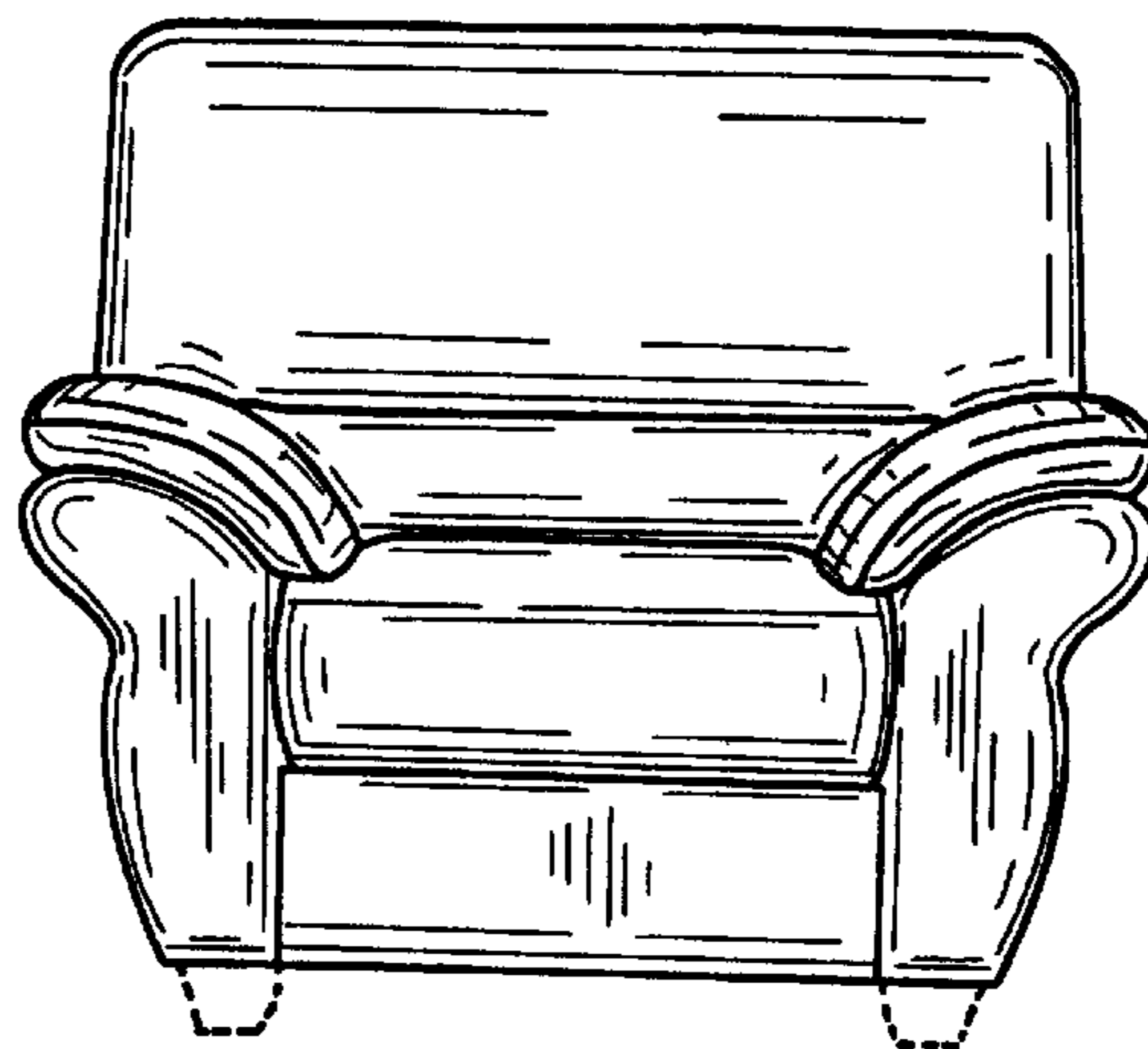

FIG. 7.