



US00D418987S

United States Patent [19] Panton

[11] **Patent Number: Des. 418,987**
[45] **Date of Patent: ** Jan. 18, 2000**

[54] **MULTIFUNCTIONAL FURNITURE**

[76] Inventor: **Verner Panton**, Kohlenberggasse 21,
CH-4051 Basel, Switzerland

[**] Term: **14 Years**

[21] Appl. No.: **29/089,013**

[22] Filed: **Jun. 5, 1998**

[30] **Foreign Application Priority Data**

Dec. 11, 1997 [WO] WIPO 003948

[51] **LOC (7) Cl.** **06-01**

[52] **U.S. Cl.** **D6/335; D6/349; D6/357;**
D6/361; D6/377; D6/482; D6/601

[58] **Field of Search** D6/334, 335, 336,
D6/349, 357, 360, 361, 364, 374, 375,
377, 381, 482, 500, 501, 502, 601; 297/232,
452.17, DIG. 1

[56] **References Cited**

U.S. PATENT DOCUMENTS

D. 235,039	5/1975	Olsen	D6/335
D. 237,764	11/1975	Prevost	D6/334
D. 255,959	7/1980	Mitchell	D6/335
D. 256,408	8/1980	Nakisbendi	D6/361
D. 278,004	3/1985	Sigona	D6/361
D. 286,586	11/1986	Radford	D6/334
D. 366,966	2/1996	Bonaddio et al.	D6/335

D. 372,367	8/1996	Bonaddio et al.	D6/375
D. 372,805	8/1996	Bonaddio et al.	D6/375
D. 396,757	8/1998	Katz et al.	D6/361
4,027,888	6/1977	Wilcox	D6/361 X

Primary Examiner—Gary D. Watson
Attorney, Agent, or Firm—Antonelli, Terry, Stout & Kraus,
LLP

[57] **CLAIM**

The ornamental design for multifunctional furniture, as shown and described.

DESCRIPTION

FIG. 1 is a top view of the present invention;
FIG. 2 is a side elevational view of FIG. 1 viewed from the left;
FIG. 3 is a side elevational view of FIG. 1 viewed from the right;
FIG. 4 is a front elevational view of FIG. 1;
FIG. 5 is a rear elevational view of FIG. 1;
FIG. 6 is a perspective view of the present invention in a first orientation;
FIG. 7 is a perspective view of the invention in a second orientation;
FIG. 8 is a perspective view of the invention in a third orientation; and,
FIG. 9 is a perspective view of the invention in a fourth orientation.

1 Claim, 4 Drawing Sheets

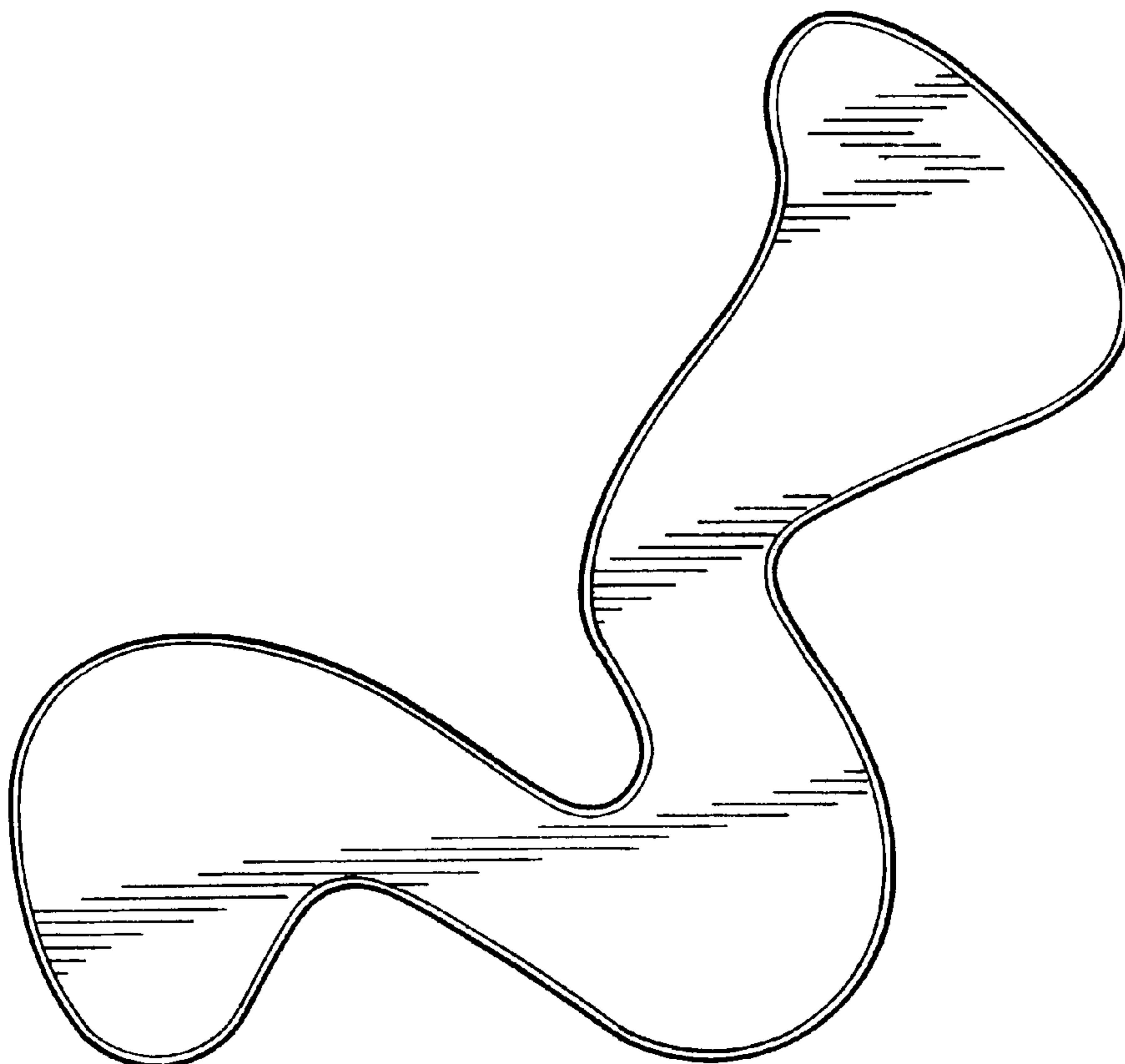

FIG. 3

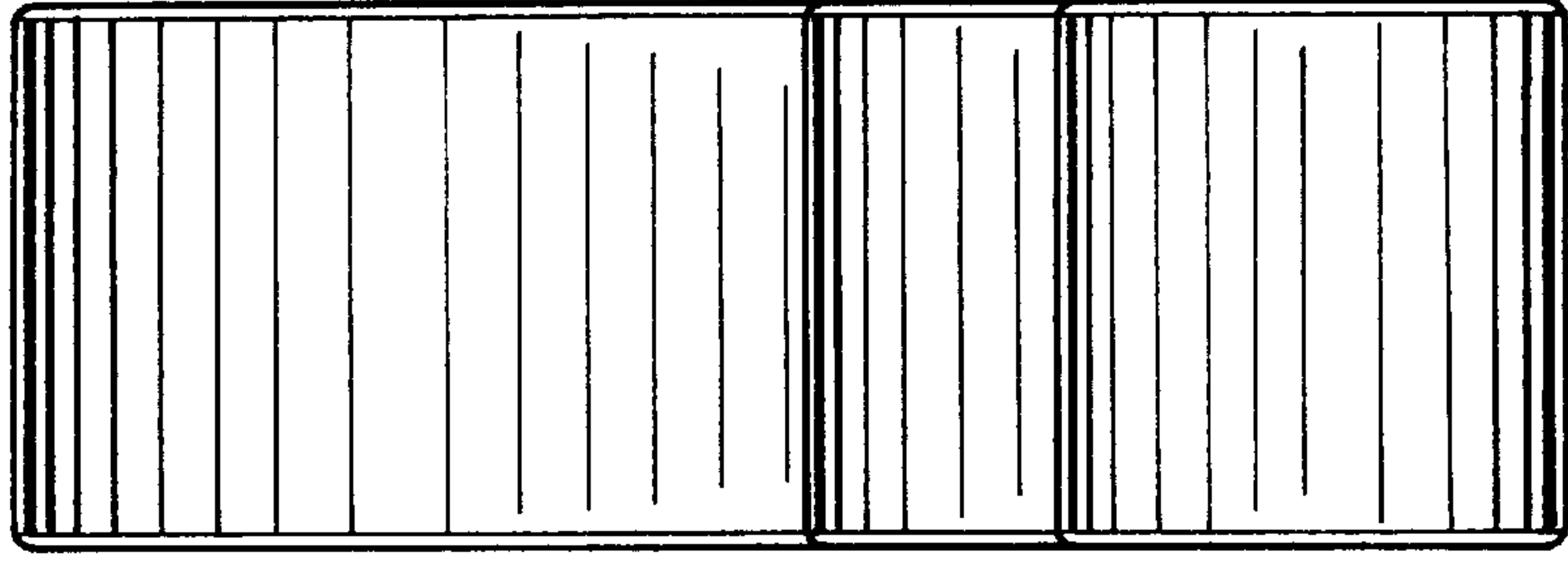

FIG. 1

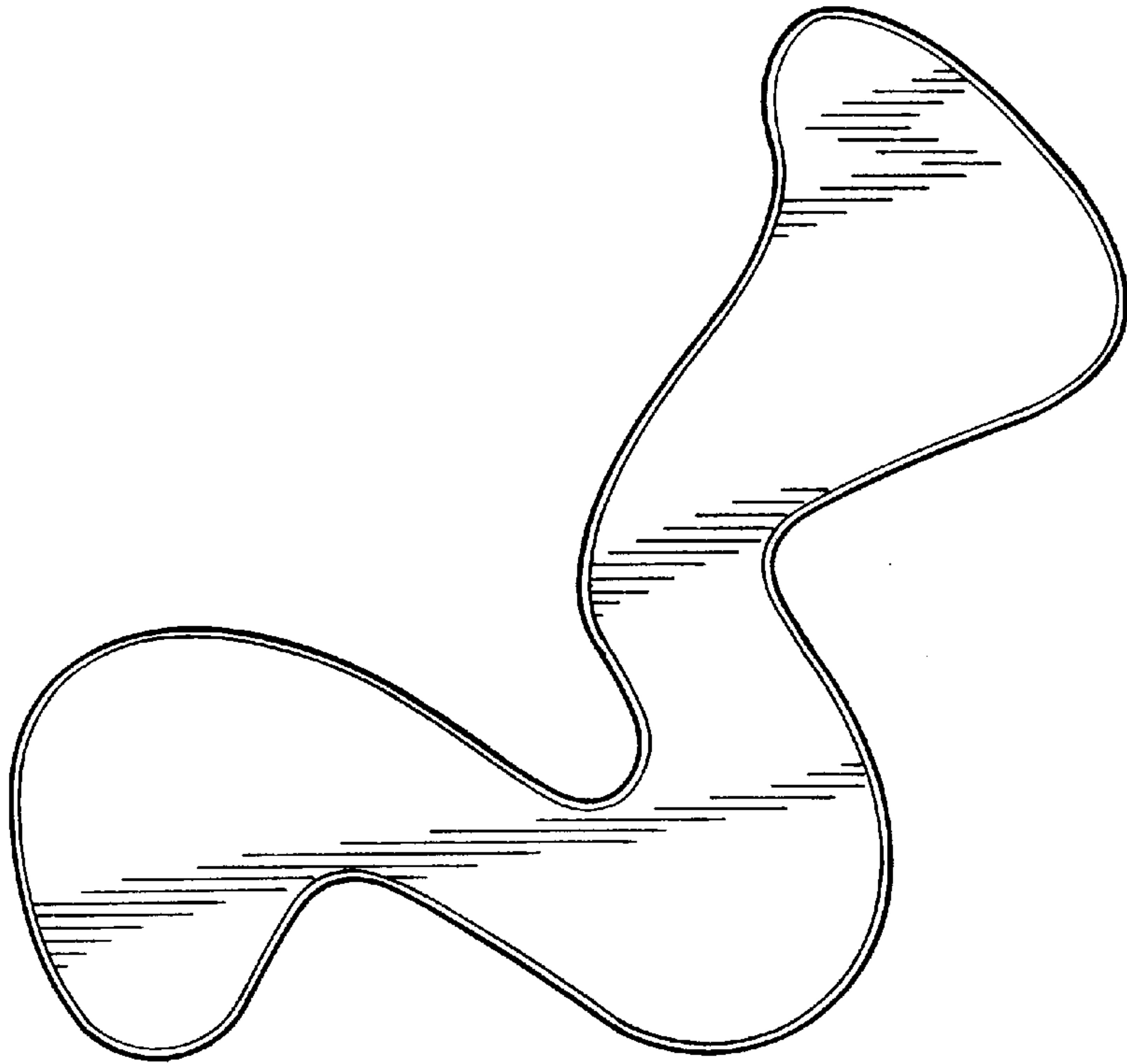

FIG. 2

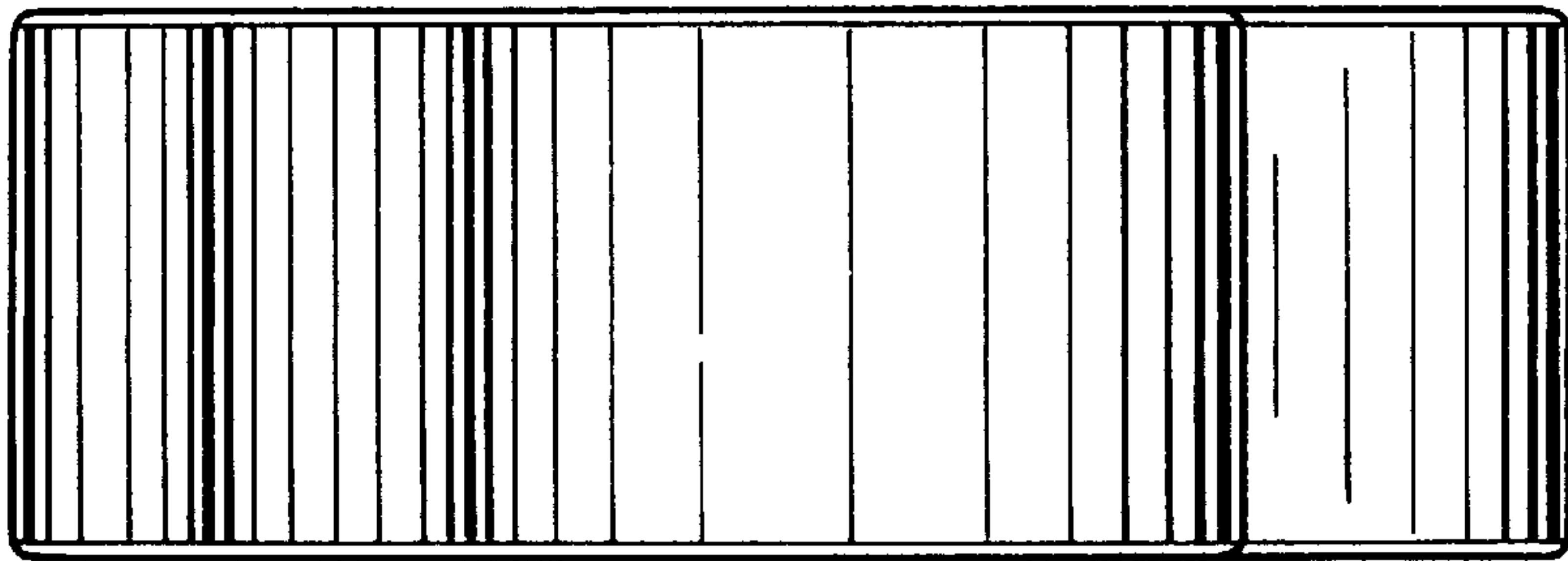

FIG. 4

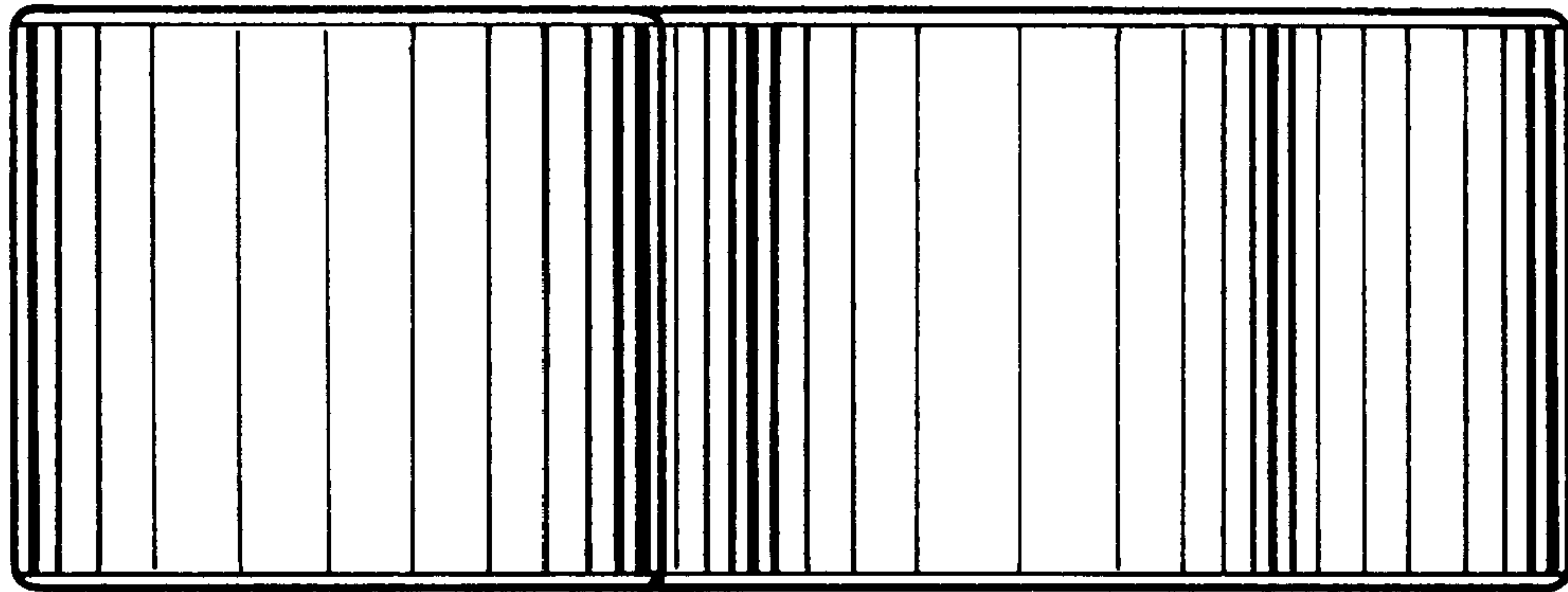

FIG. 5

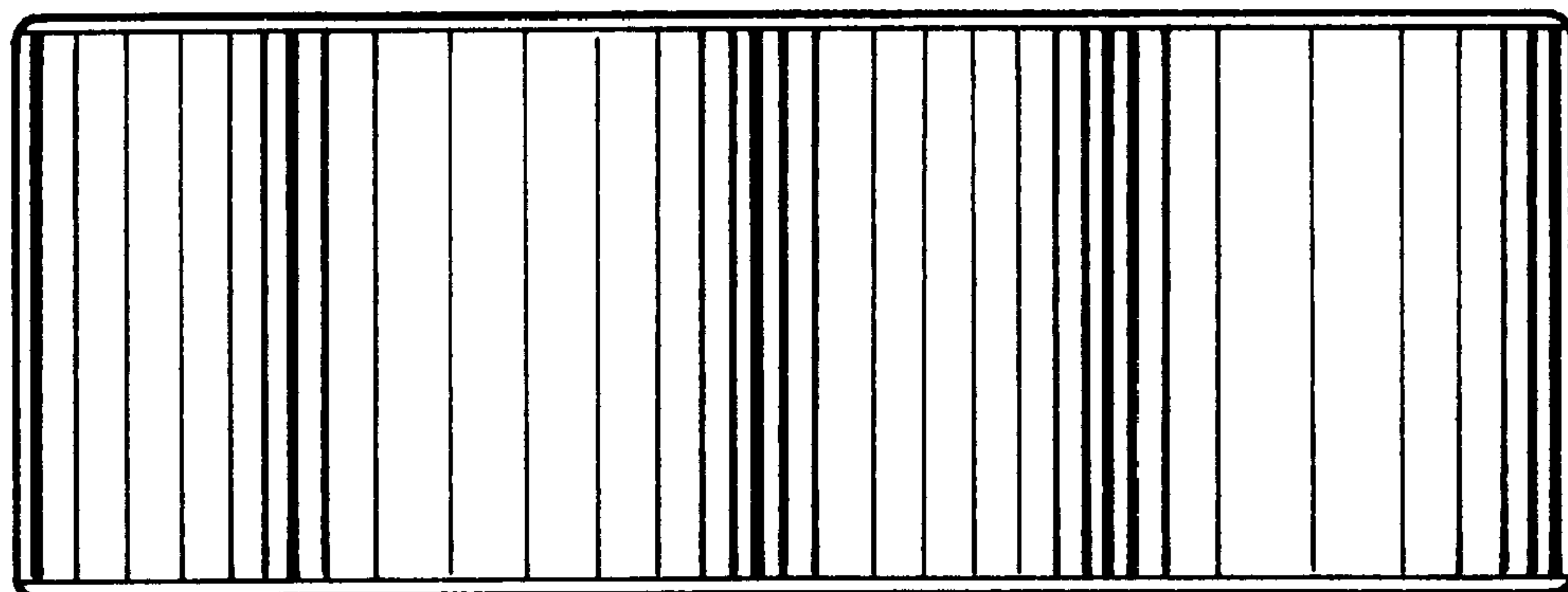

FIG. 6

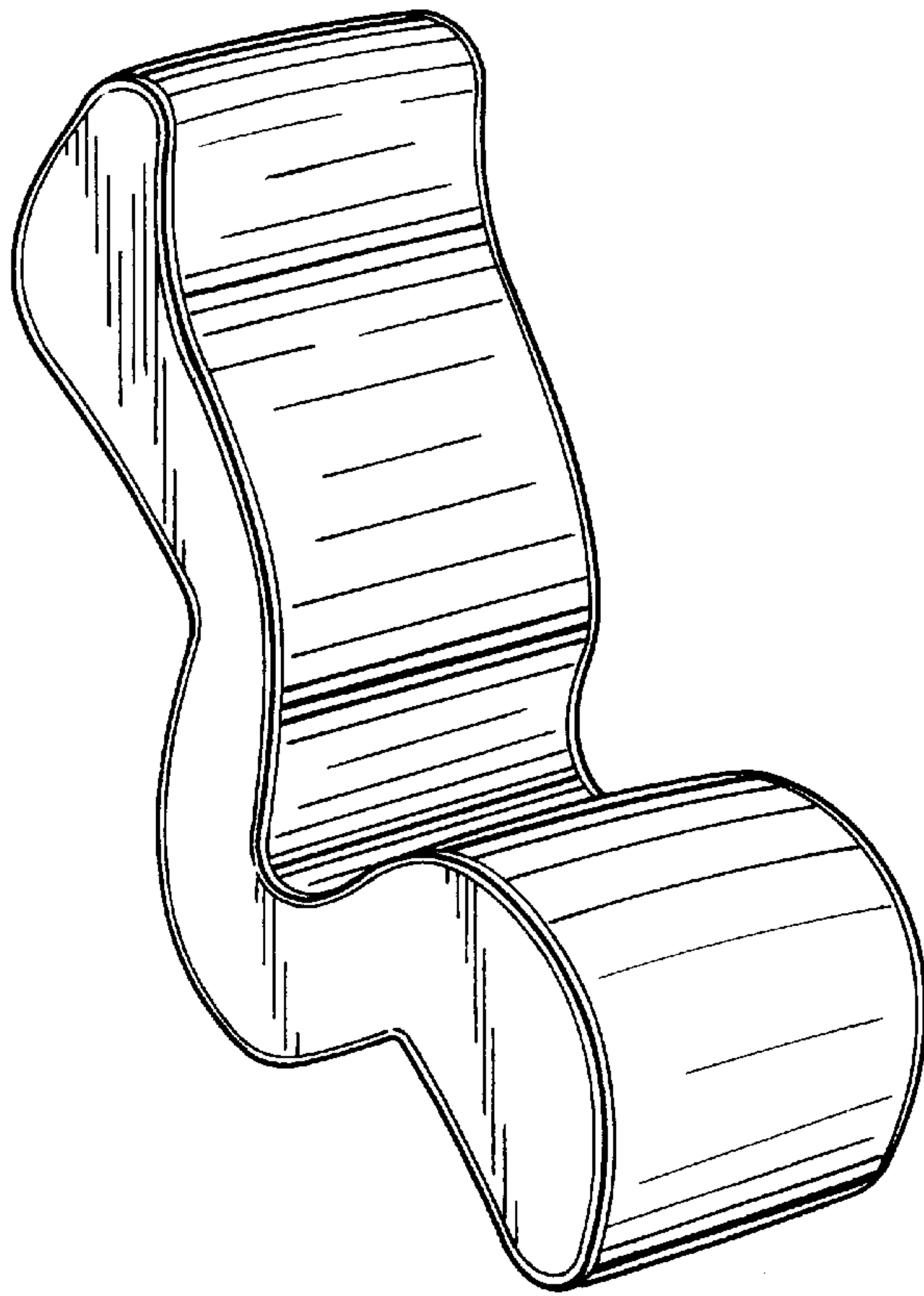

FIG. 7

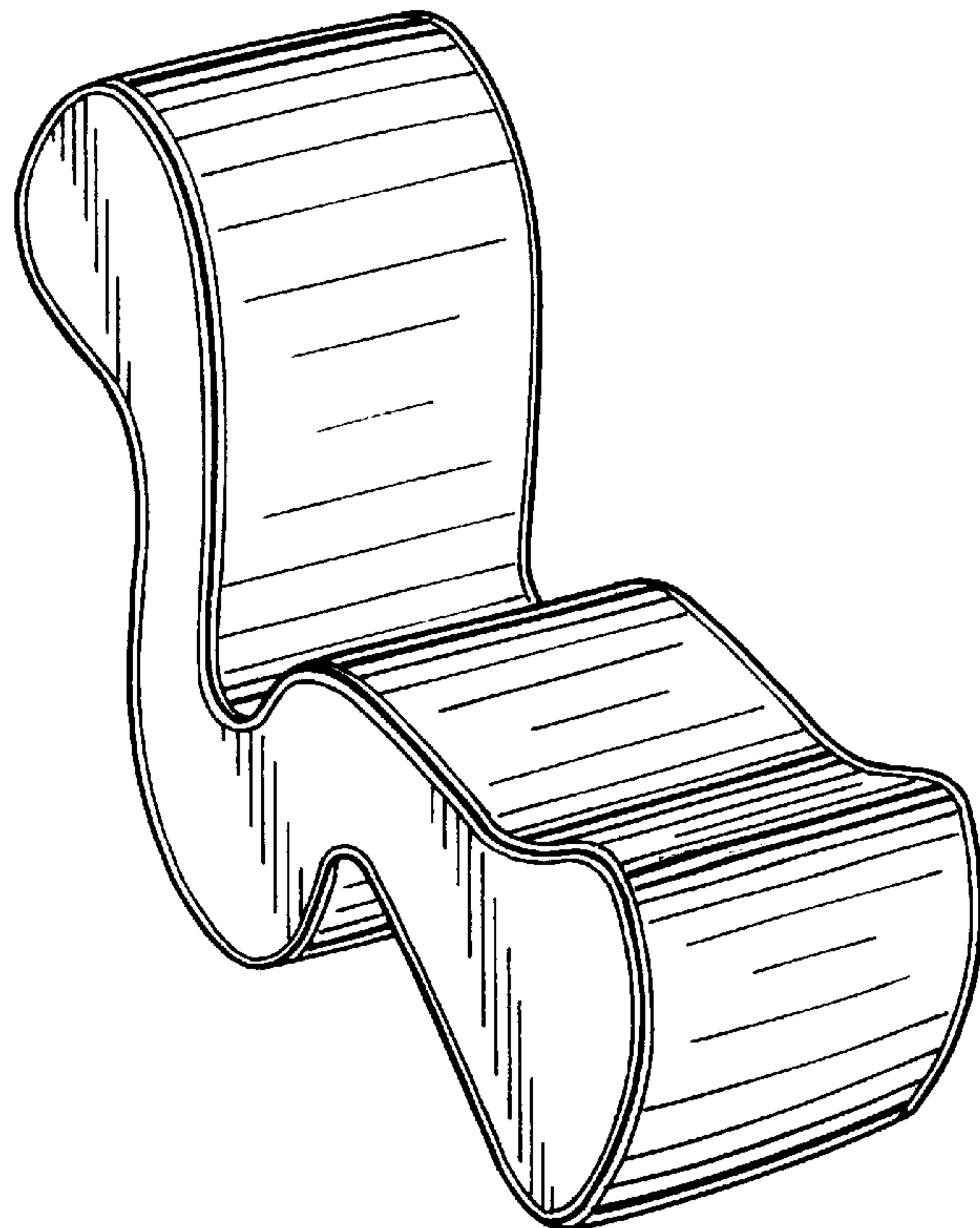

FIG. 8

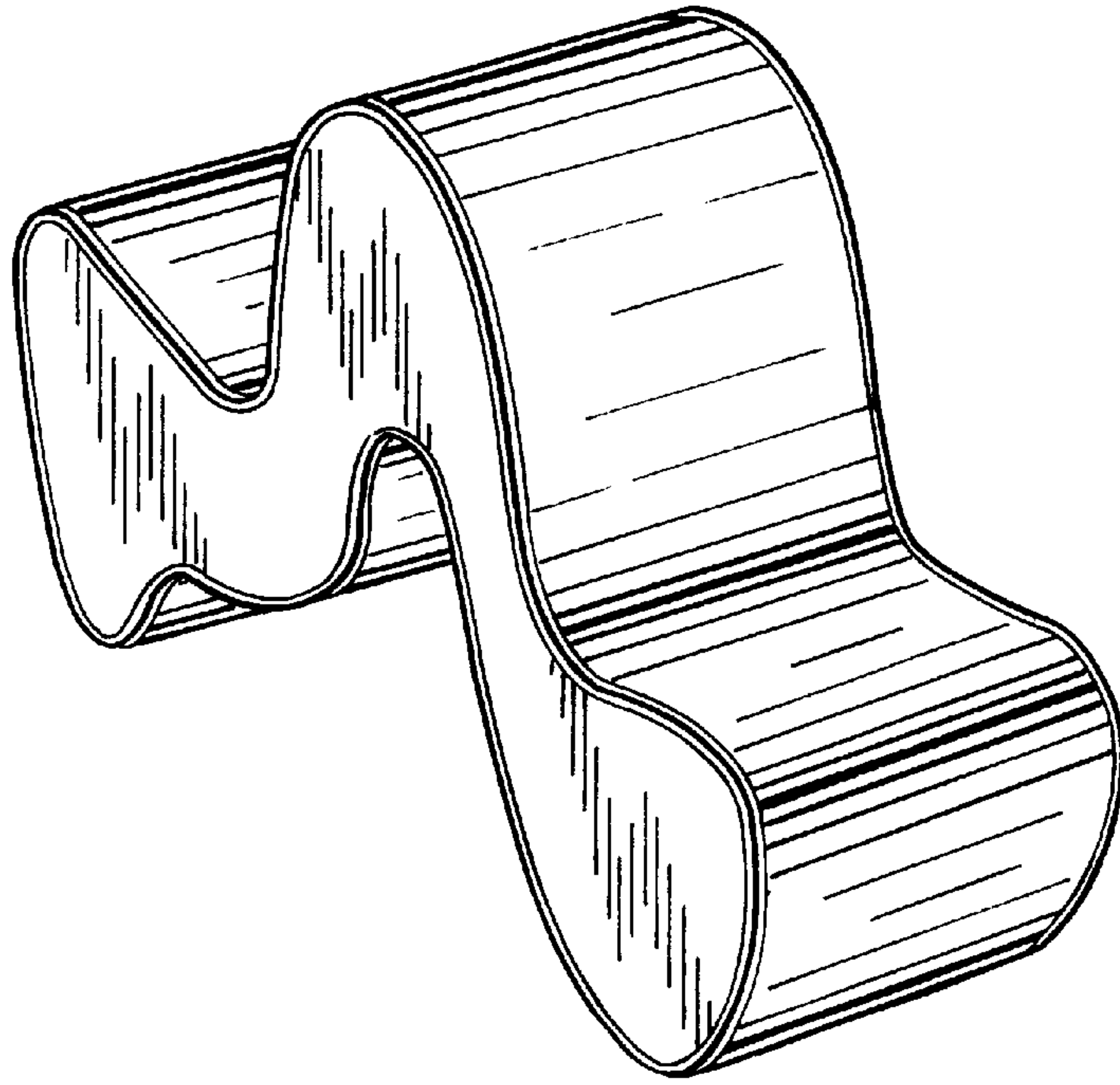

FIG. 9

