



US00D418913S

**United States Patent** [19]  
**Thakur**

[11] **Patent Number: Des. 418,913**  
[45] **Date of Patent: \*\* Jan. 11, 2000**

[54] **UPRIGHT FAN**

D. 412,565 8/1999 Lee ..... D23/332

[76] Inventor: **Doulat Kumar Thakur**, 8Fl., No. 25,  
Sec. 1, Nanking E. Rd., Taipei, Taiwan

*Primary Examiner*—Lisa Lichtenstein  
*Attorney, Agent, or Firm*—Jones, Tullar & Cooper, PC

[\*\*] Term: **14 Years**

[57] **CLAIM**

[21] Appl. No.: **29/103,745**

The ornamental design for an upright fan, as shown.

[22] Filed: **Apr. 22, 1999**

**DESCRIPTION**

[51] **LOC (7) Cl.** ..... **23-04**

FIG. 1 is a perspective view of an upright fan, showing my new design;

[52] **U.S. Cl.** ..... **D23/378; D23/382**

FIG. 2 is a front elevational view thereof;

[58] **Field of Search** ..... D23/370, 378,  
D23/381, 382, 335, 336, 332, 411, 412;  
416/246 R, 247 R, 244 R

FIG. 3 is a rear elevational view thereof;

FIG. 4 is a left side elevational view thereof;

FIG. 5 is a right side elevational view thereof;

FIG. 6 is top plan view thereof; and,

FIG. 7 is a bottom plan view thereof.

[56] **References Cited**

**U.S. PATENT DOCUMENTS**

D. 355,483 2/1995 Litvin et al. .... D23/378

**1 Claim, 6 Drawing Sheets**

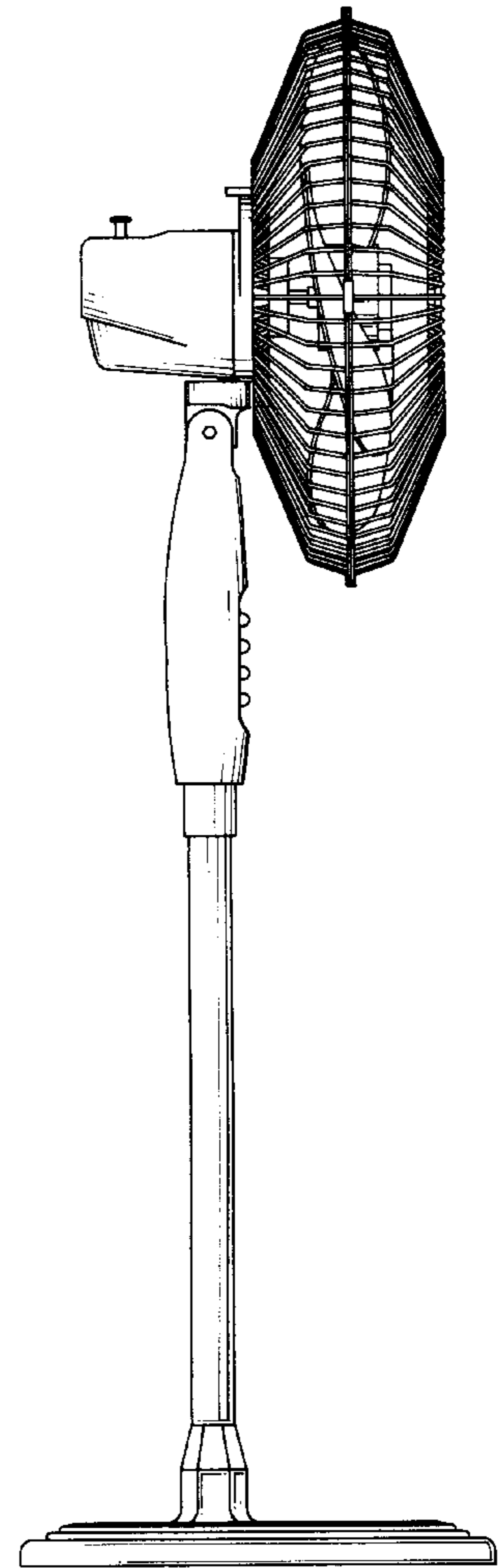
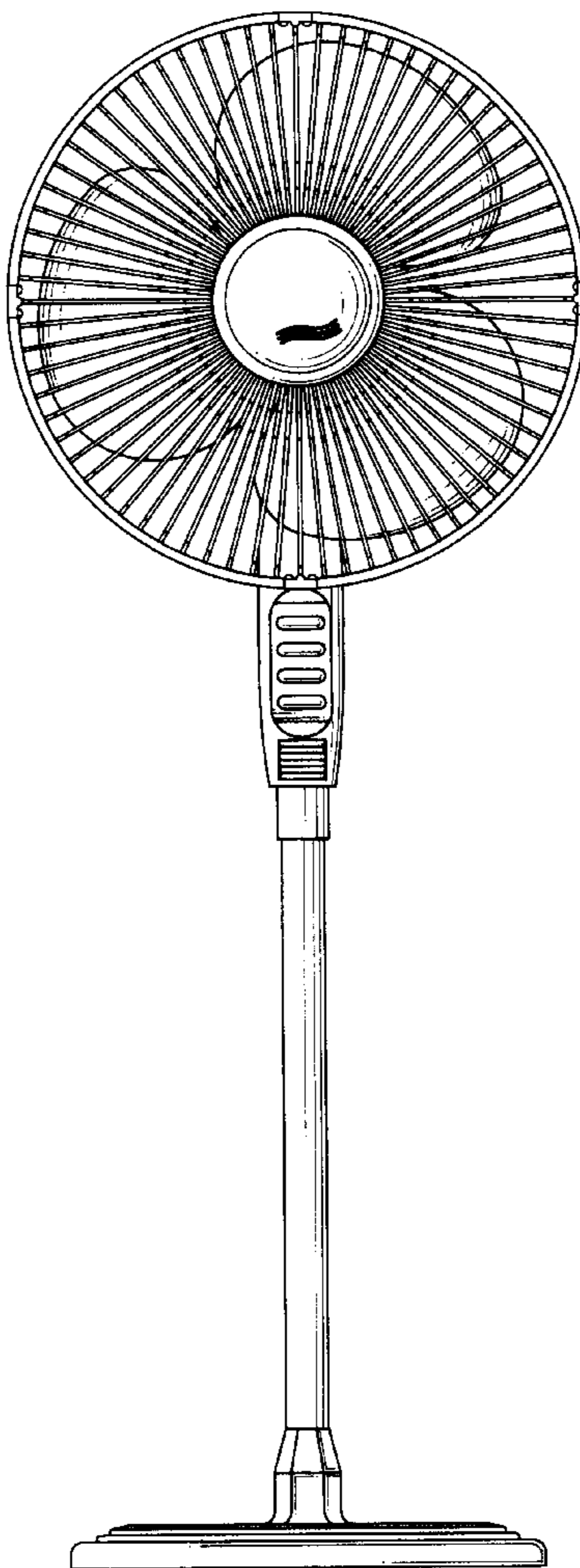
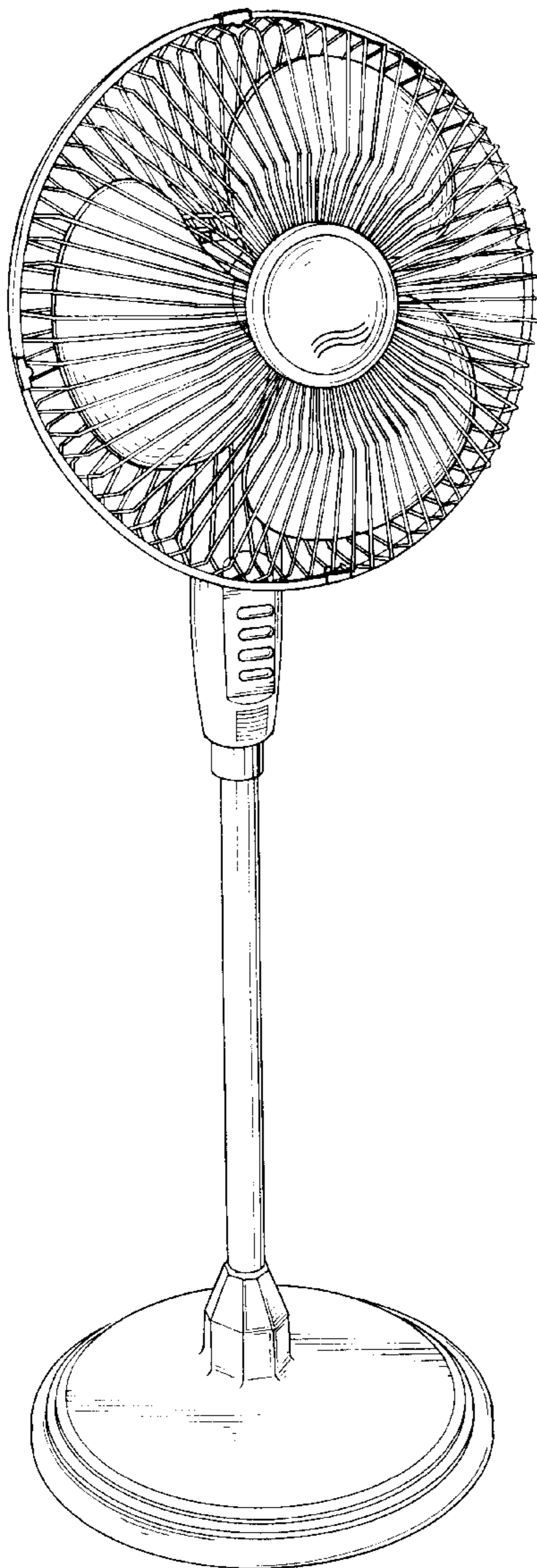

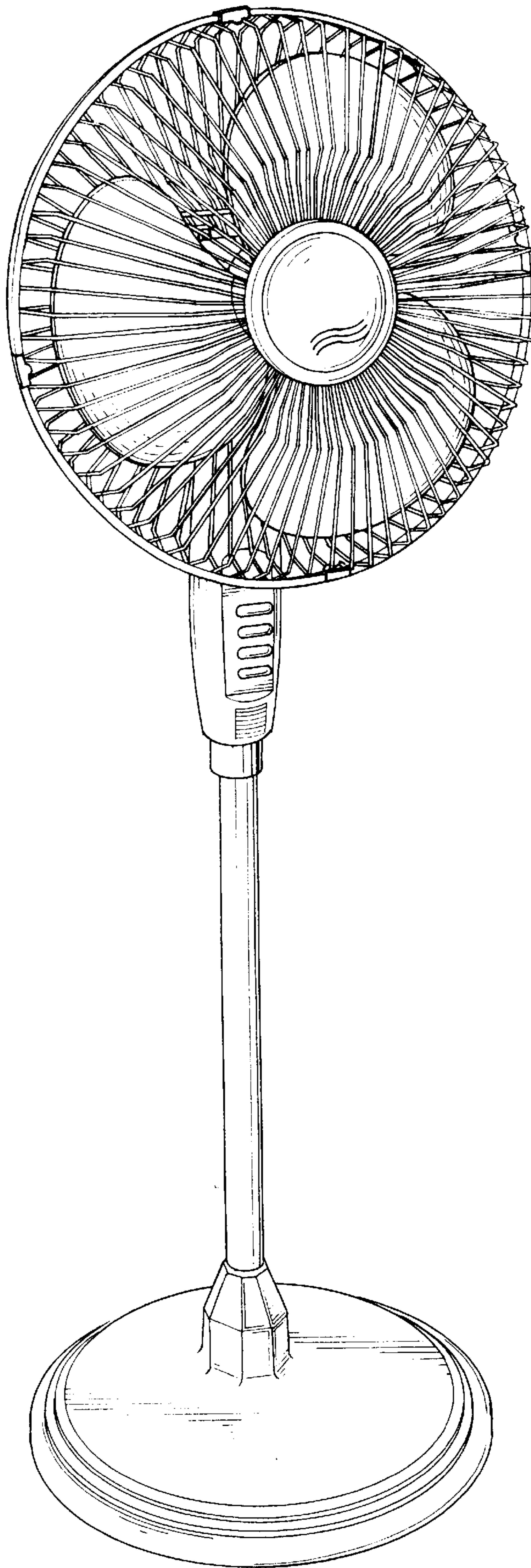

FIG. 1

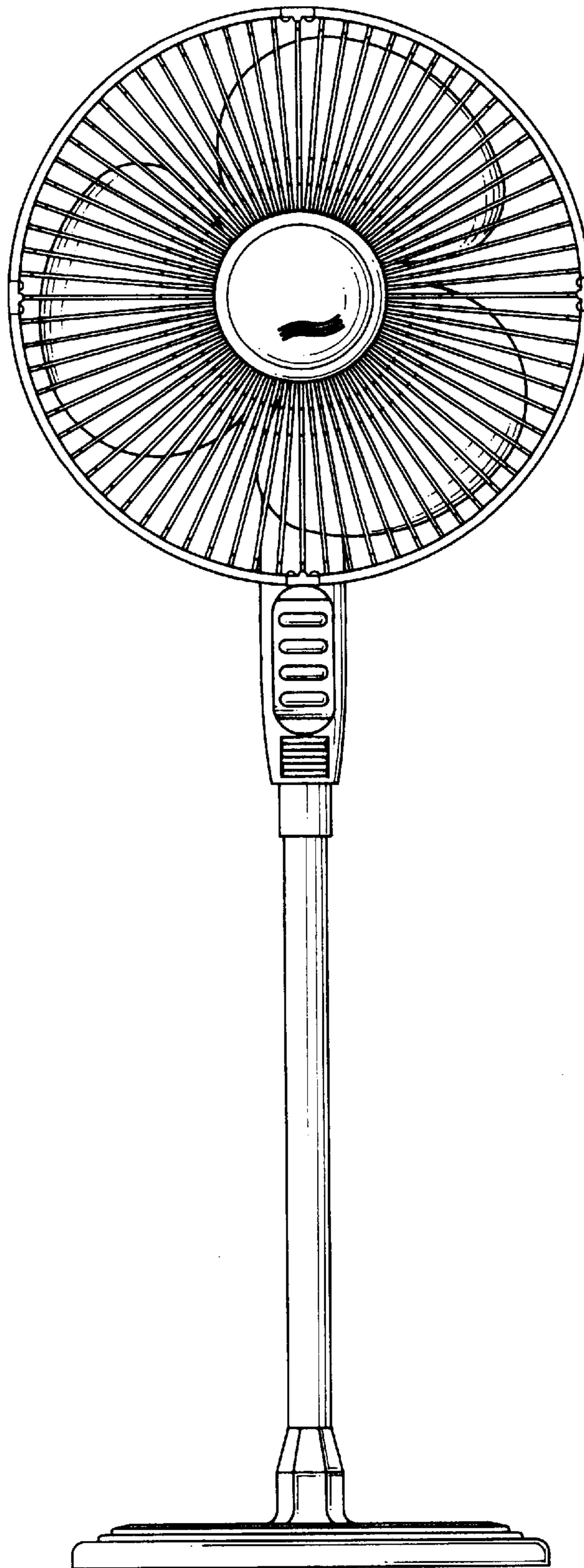

FIG. 2

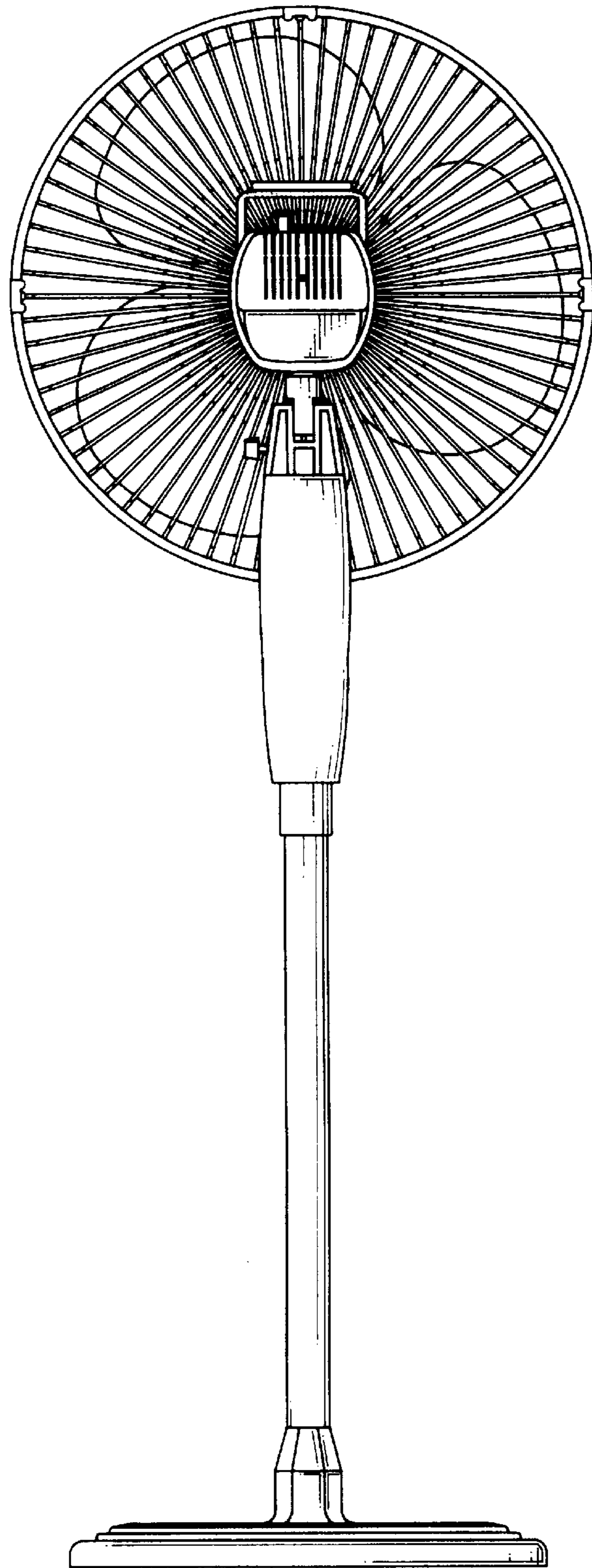

FIG. 3

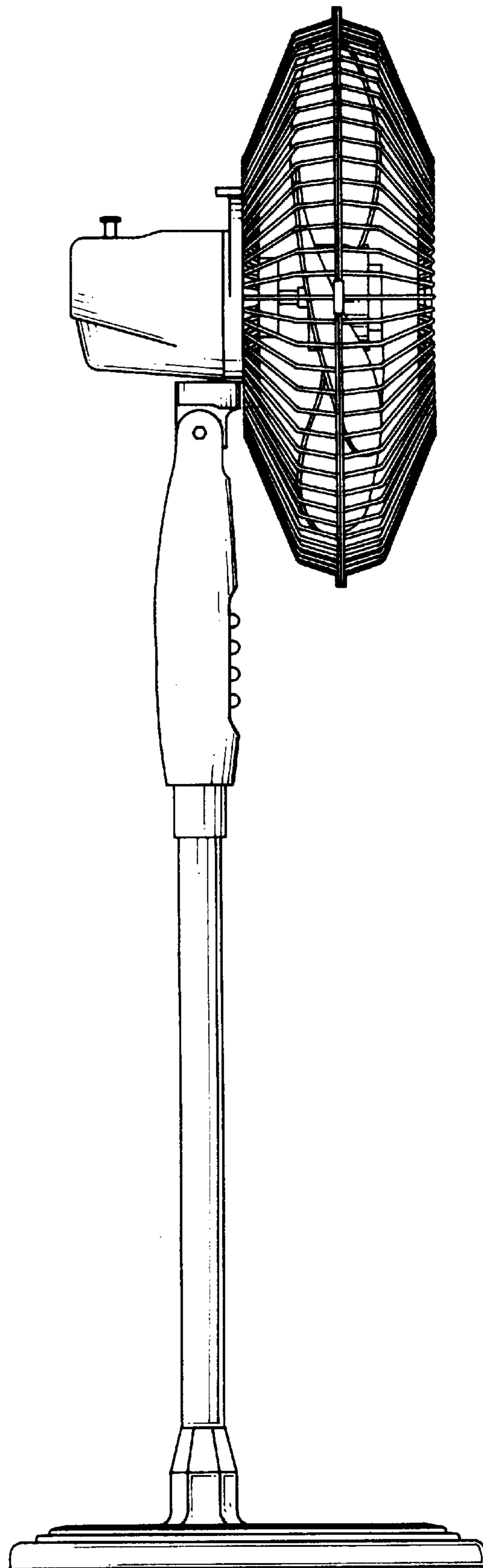

FIG. 4

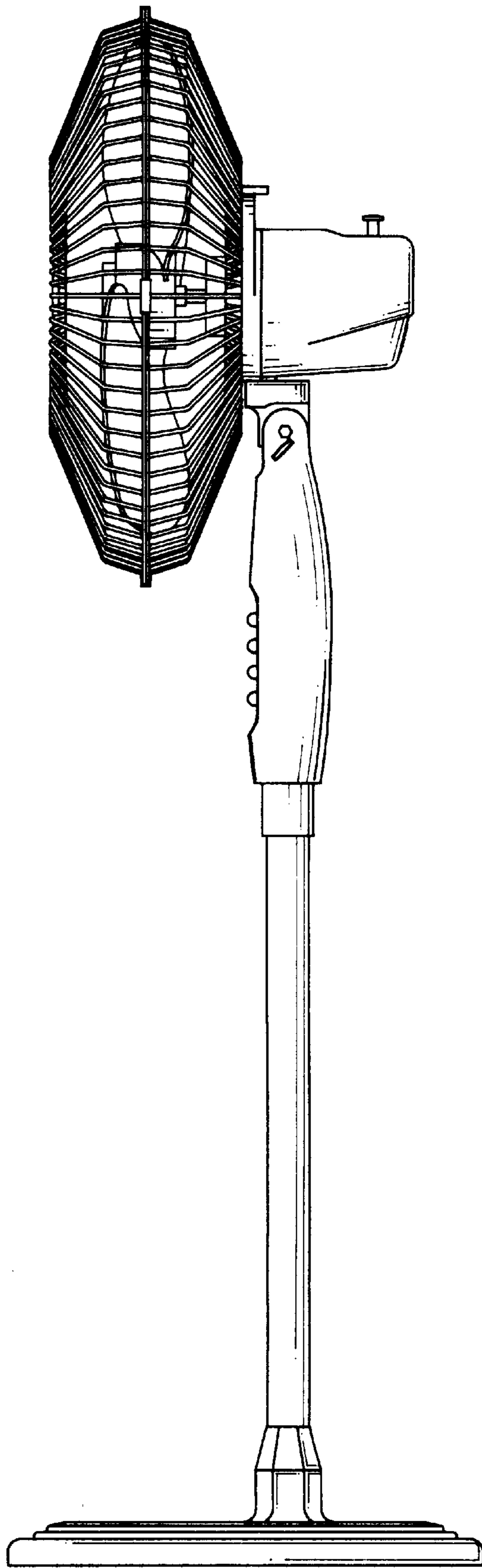

FIG. 5

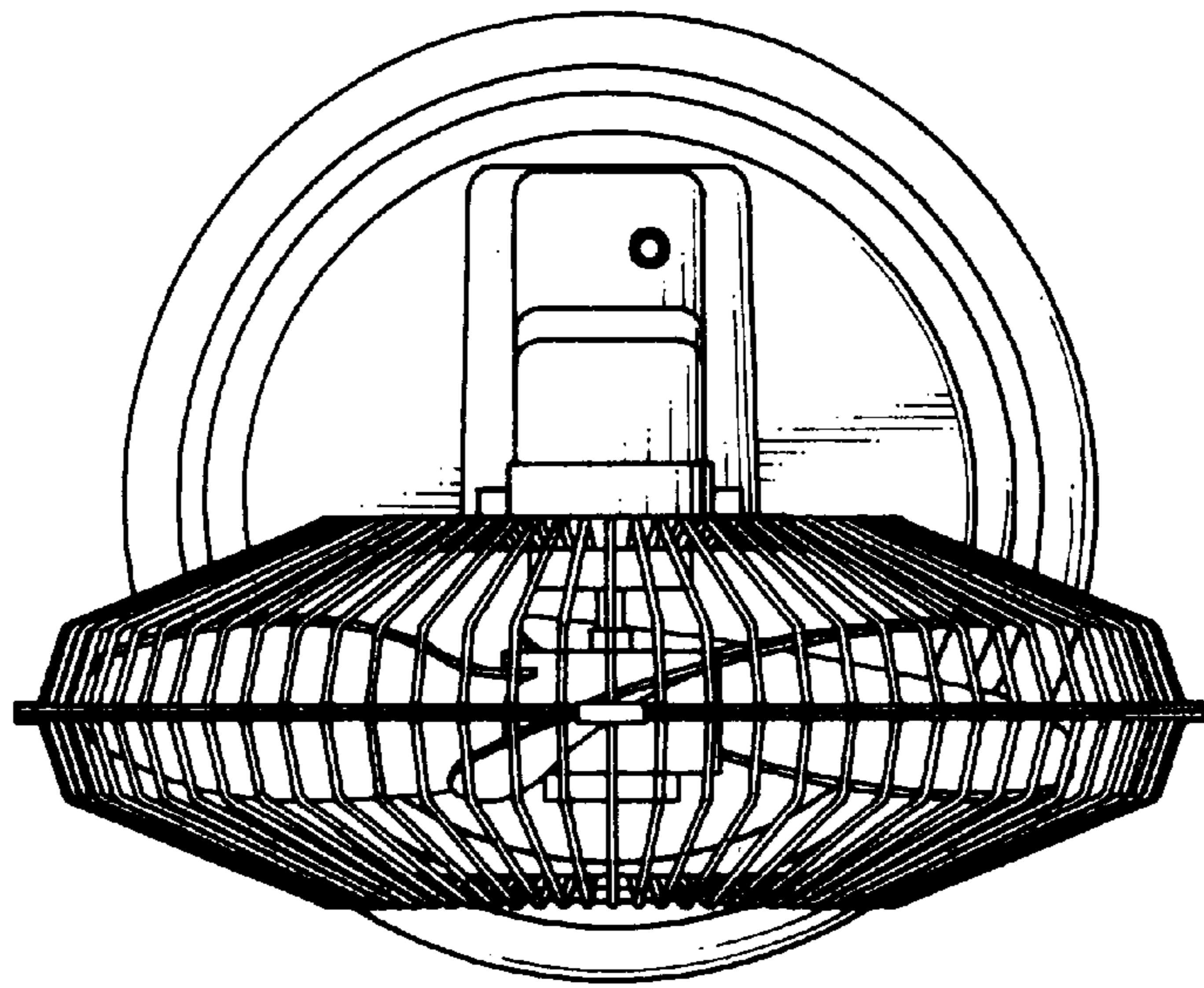

FIG. 6

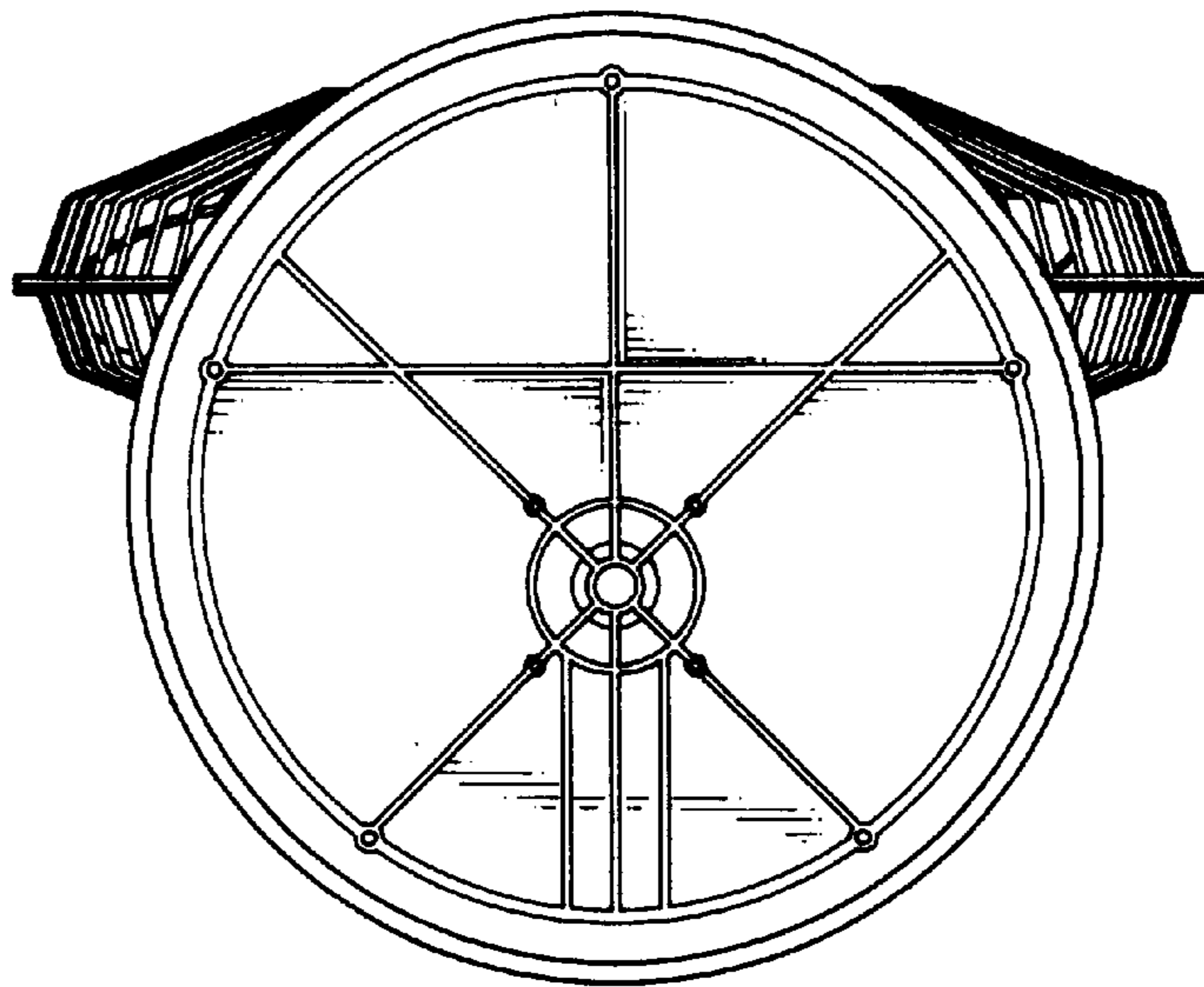

FIG. 7