



US00D418720S

United States Patent [19]

[11] **Patent Number: Des. 418,720**

Lillelund et al.

[45] **Date of Patent: ** Jan. 11, 2000**

[54] **STORAGE CONTAINER**

[75] Inventors: **Stig Lillelund**, Gentofte; **Jakob Heiberg**, Charlottenlund; **Hanne Dalsgaard Jeppesen**, Holte, all of Denmark; **Robert H. C. M. Daenen**, Essene, Belgium

[73] Assignee: **Dart Industries Inc.**, Orlando, Fla.

[**] Term: **14 Years**

[21] Appl. No.: **29/091,887**

[22] Filed: **Aug. 7, 1998**

[51] **LOC (7) Cl.** **07-06**

[52] **U.S. Cl.** **D7/602**

[58] **Field of Search** D7/538-549, 601, D7/602, 612-615, 629; D9/424, 425; 206/505, 507, 514, 515; 220/574, 657, 669, 675

[56] **References Cited**

U.S. PATENT DOCUMENTS

- D. 276,400 11/1984 Daenen et al. .
- D. 276,402 11/1984 Daenen et al. .

(List continued on next page.)

Primary Examiner—Terry A. Wallace
Attorney, Agent, or Firm—Taylor J. Ross

[57] **CLAIM**

The ornamental design for a storage container, as shown and described.

DESCRIPTION

FIG. 1 is a top, side and front perspective view of a first embodiment of a storage container showing our new design; FIG. 2 is a right side elevation view thereof; FIG. 3 is a left side elevation view thereof; FIG. 4 is a front elevation view thereof; FIG. 5 is rear elevation view thereof; FIG. 6 is a top plan view thereof; FIG. 7 is a bottom plan view thereof; FIG. 8 is a cross-sectional view thereof along line 8—8 of FIG. 6;

FIG. 9 is a cross-sectional view thereof along line 9—9 of FIG. 6; and
 FIG. 10 is a cross-sectional view thereof along line 10—10 of FIG. 5;
 FIG. 11 is a top, side and front perspective view of a second embodiment of a storage container showing my new design; FIG. 12 is a right side elevation view thereof; FIG. 13 is a left side elevation view thereof; FIG. 14 is a front elevation view thereof; FIG. 15 is rear elevation view thereof; FIG. 16 is a top plan view thereof; FIG. 17 is a bottom plan view thereof; FIG. 18 is a cross-sectional view thereof along line 18—18 of FIG. 16;
 FIG. 19 is a cross-sectional view thereof along line 19—19 of FIG. 16; and
 FIG. 20 is a cross-sectional view thereof along line 20—20 of FIG. 14;
 FIG. 21 is a top, side and front prespective view of a third embodiment of a storage container showing my new design; FIG. 22 is a right side elevation view thereof; FIG. 23 is a left side elevation view thereof; FIG. 24 is a front elevation view thereof; FIG. 25 is a rear elevation view thereof; FIG. 26 is a top plan view thereof; FIG. 27 is a bottom plan view thereof; FIG. 28 is a cross-sectional view thereof along line 28—28 of FIG. 26;
 FIG. 29 is a cross-sectional view thereof along line 29—29 of FIG. 26; and
 FIG. 30 is a cross-sectional view thereof along line 30—30 of FIG. 25;
 FIG. 31 is a top, side and front perspective view of a fourth embodiment of a storage container showing my new design; FIG. 32 is a right side elevation view thereof; FIG. 33 is a left side elevation view thereof; FIG. 34 is a front elevation view thereof; FIG. 35 is a rear elevation view thereof; FIG. 36 is a top plan view thereof; FIG. 37 is a bottom plan view thereof; FIG. 38 is a cross-sectional view thereof along line 38—38 of FIG. 36;
 FIG. 39 is a cross-sectional view thereof along line 39—39 of FIG. 36; and,
 FIG. 40 is a cross-sectional view thereof along line 40—40 of FIG. 35.

1 Claim, 20 Drawing Sheets

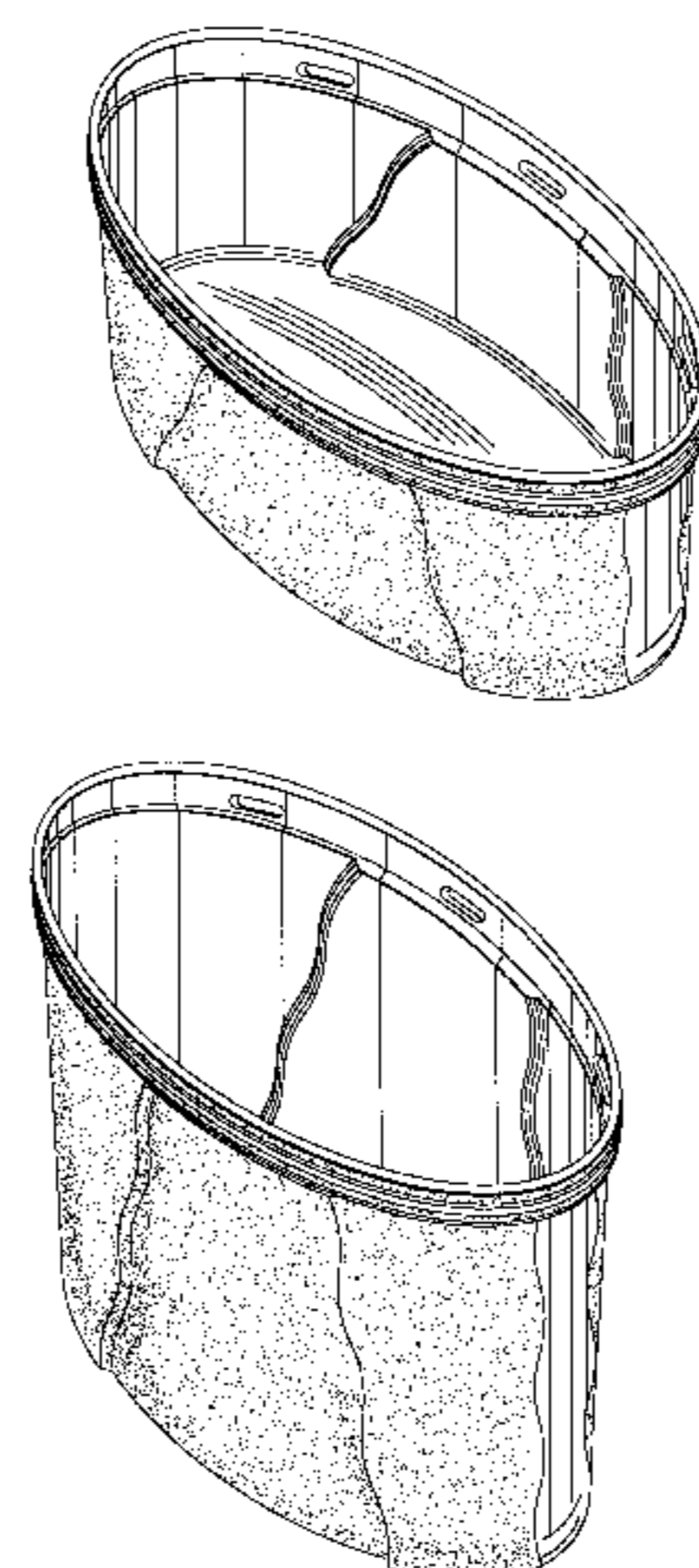

Des. 418,720

Page 2

U.S. PATENT DOCUMENTS				
D. 279,251	6/1985	Daenen et al. .	D. 350,255	9/1994 Daenen et al. .
D. 280,281	8/1985	Conti et al. .	D. 352,425	11/1994 Daenen et al. D7/602
D. 287,325	12/1986	Schmidt .	D. 371,053	6/1996 Lillelund et al. D7/612
D. 312,968	12/1990	Wolff D9/431	D. 372,401	8/1996 Lillelund et al. D7/612
			D. 382,763	8/1997 Jeppesen et al. D7/316

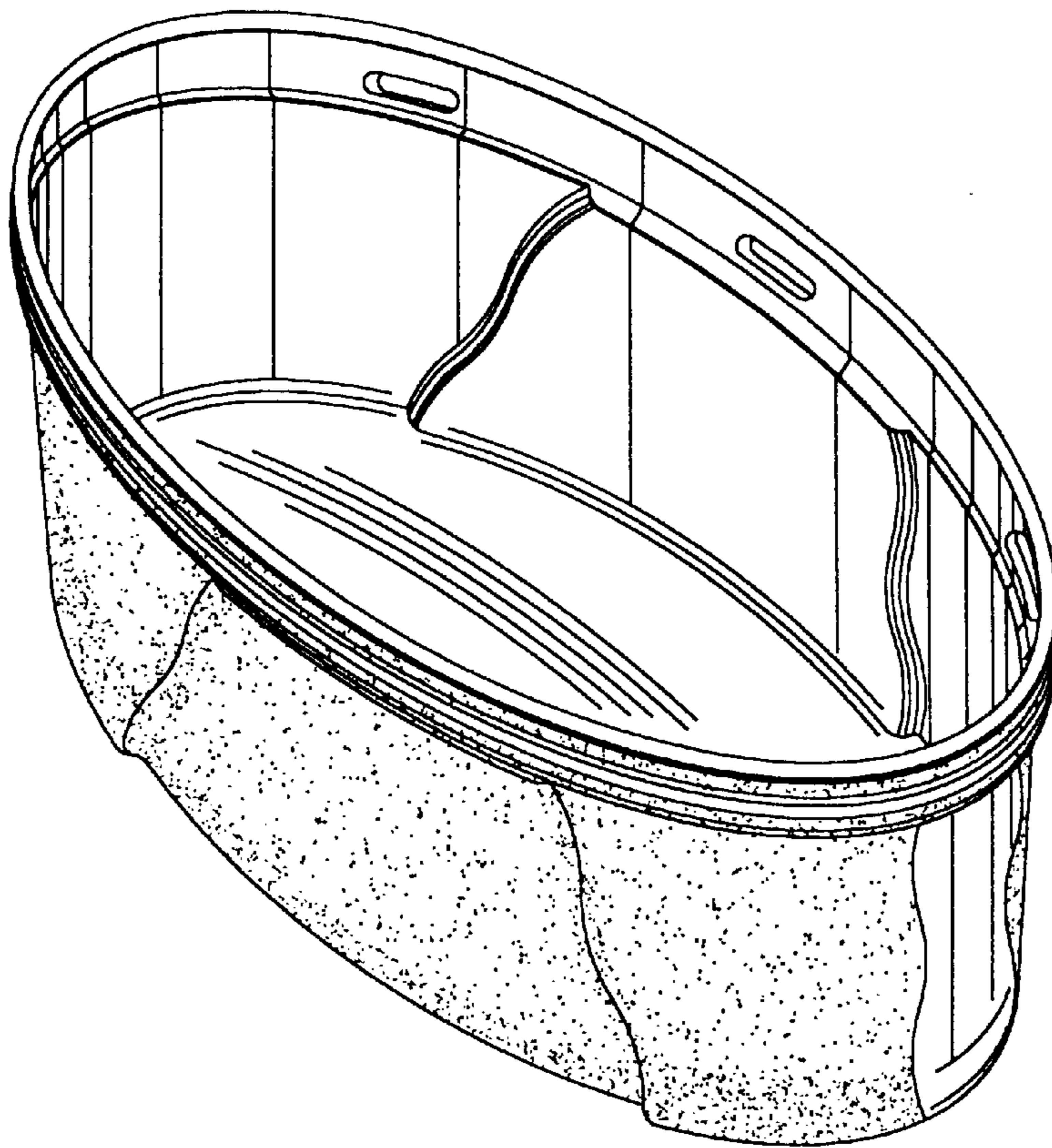

FIG. 1

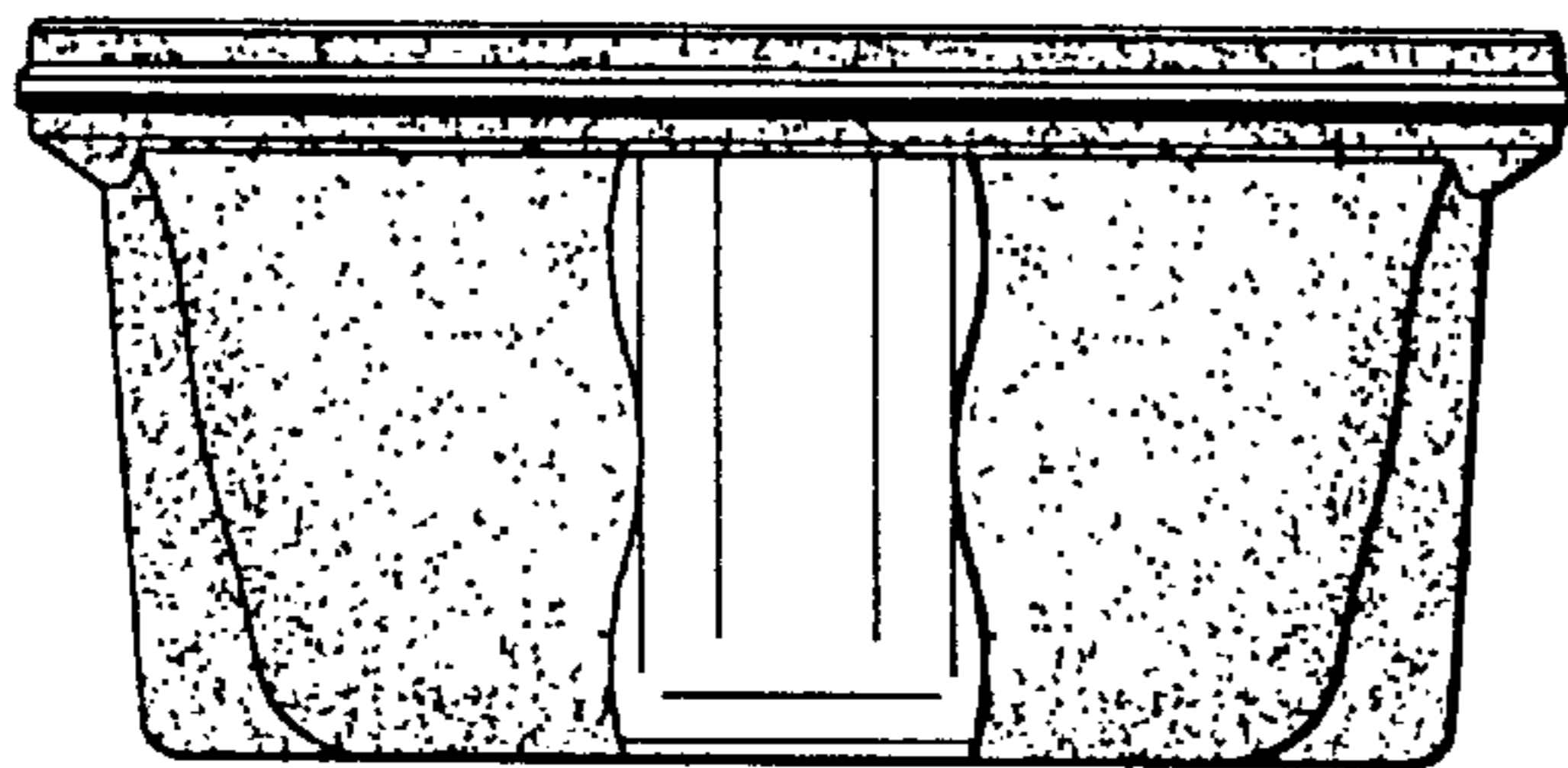

FIG. 2

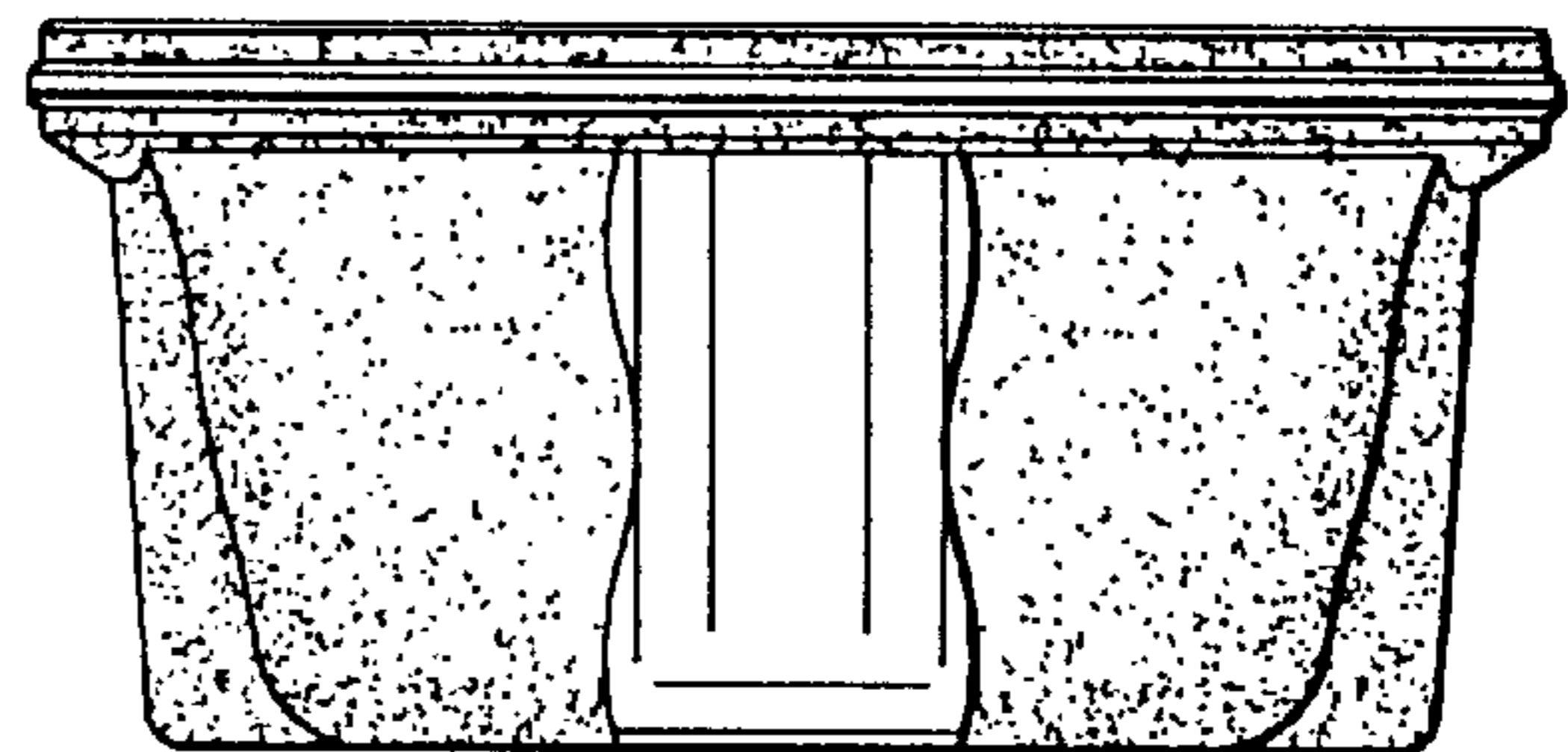

FIG. 3



FIG. 4

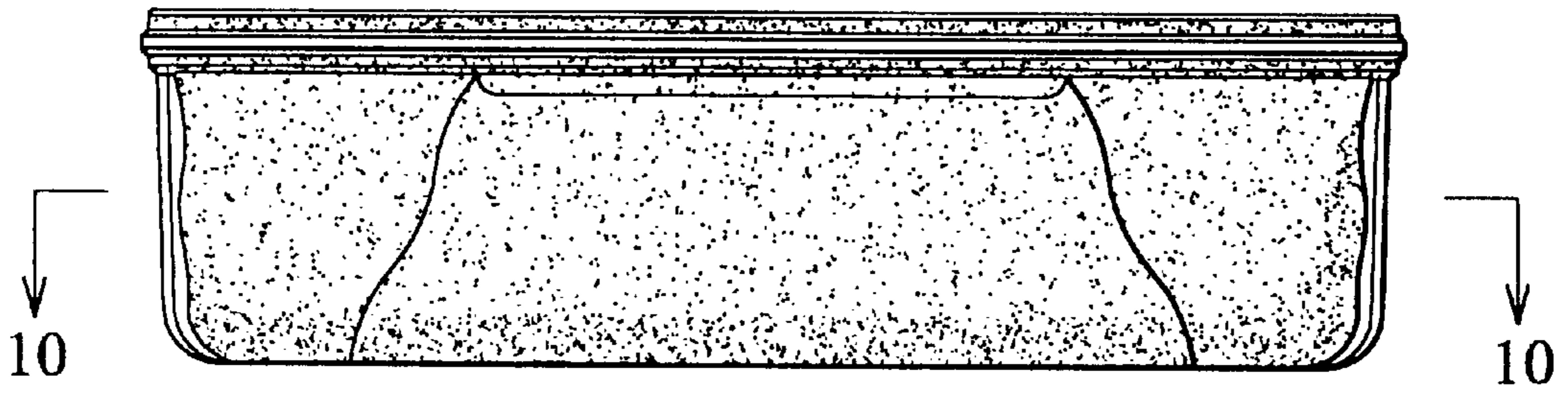

FIG. 5

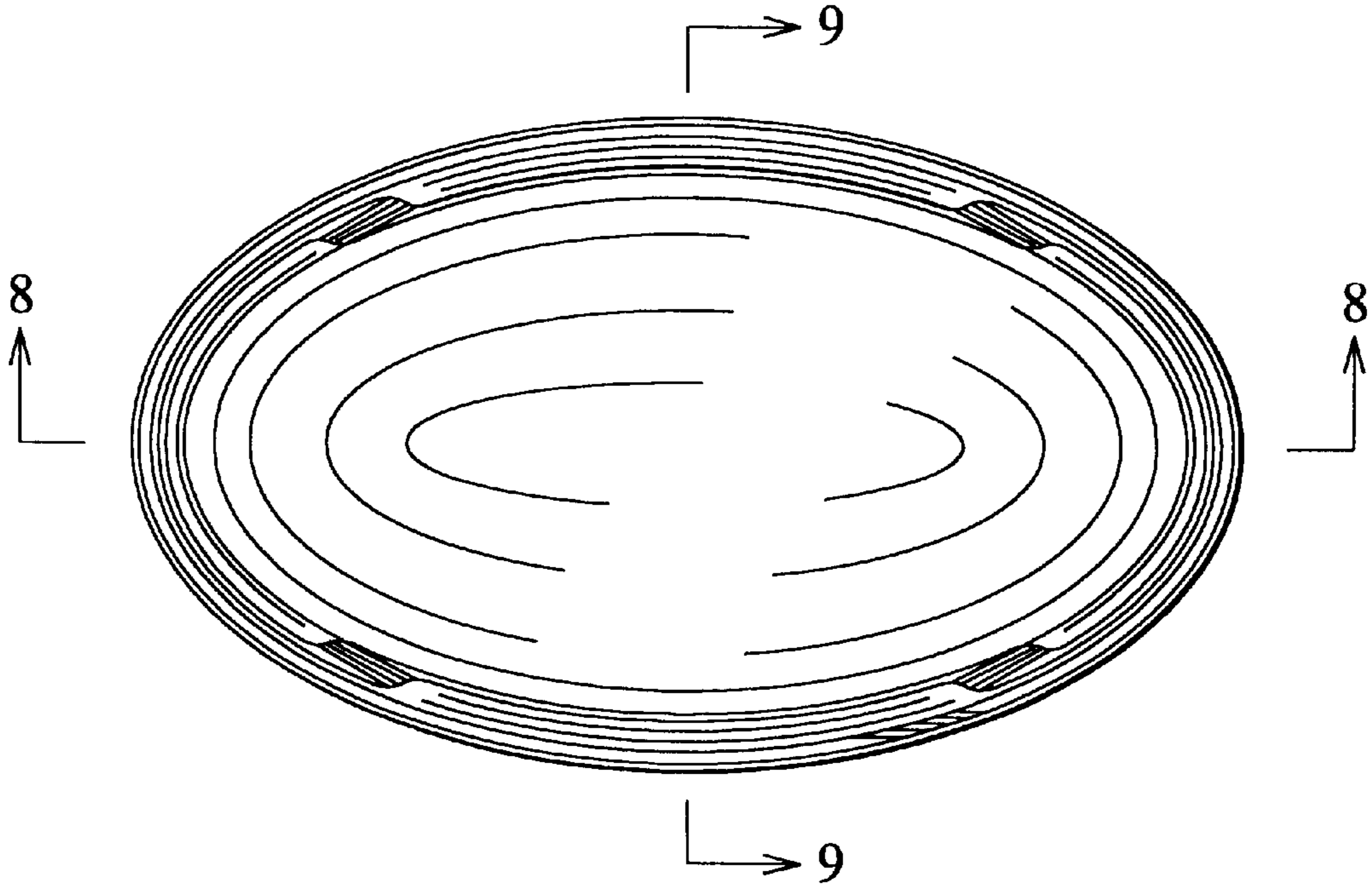

FIG. 6

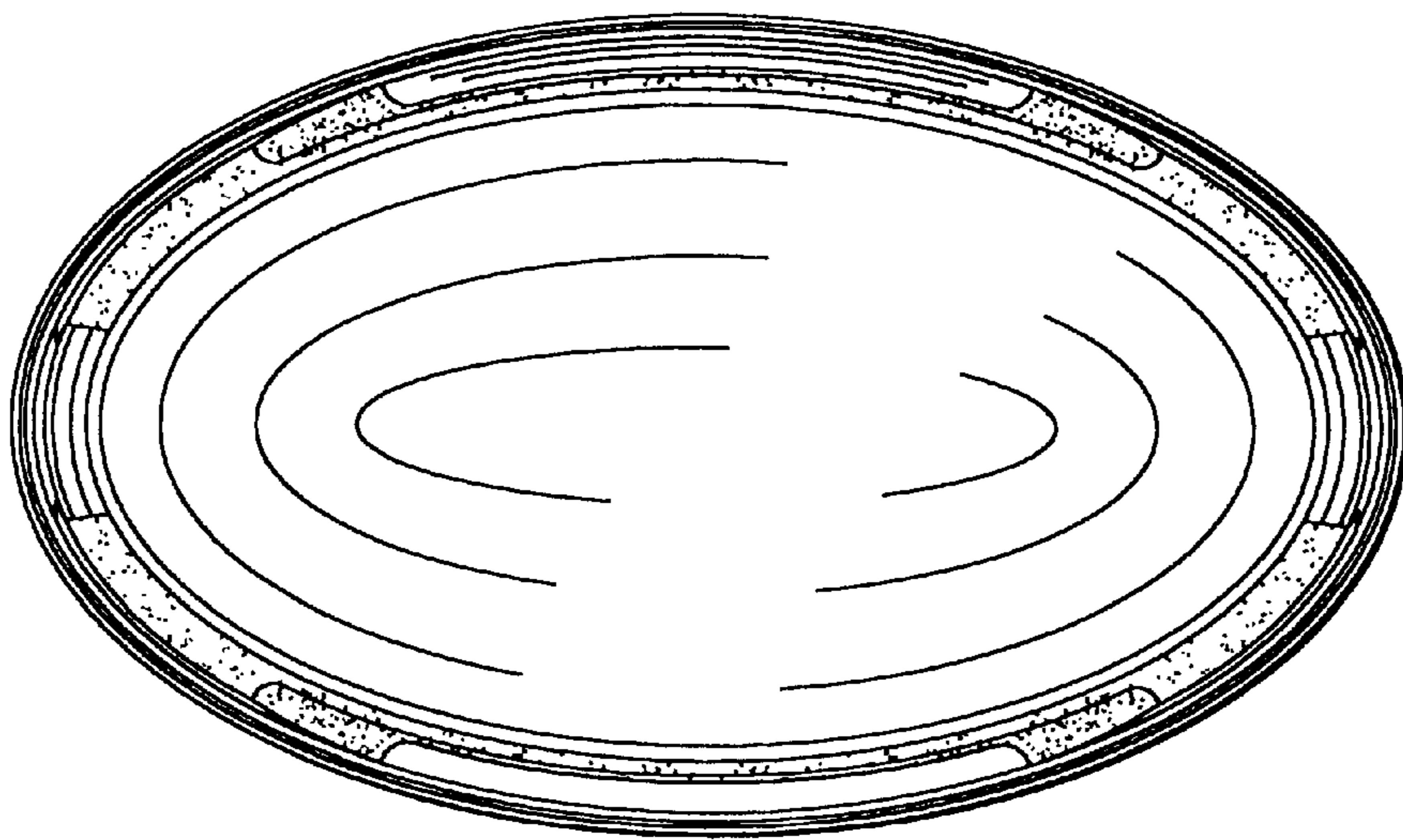

FIG. 7

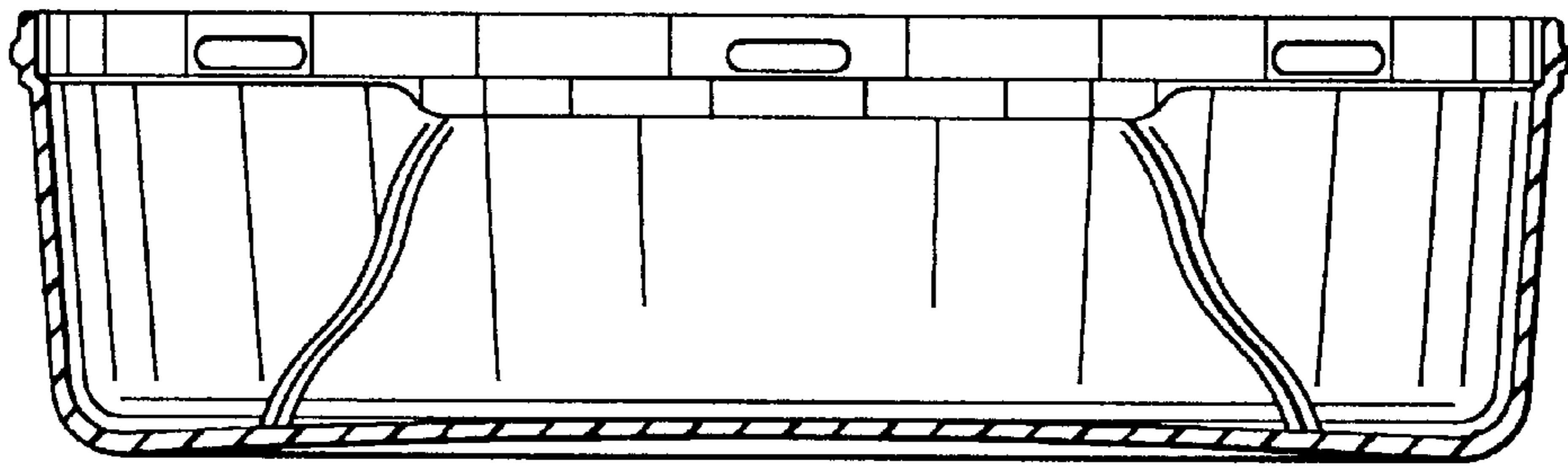

FIG. 8

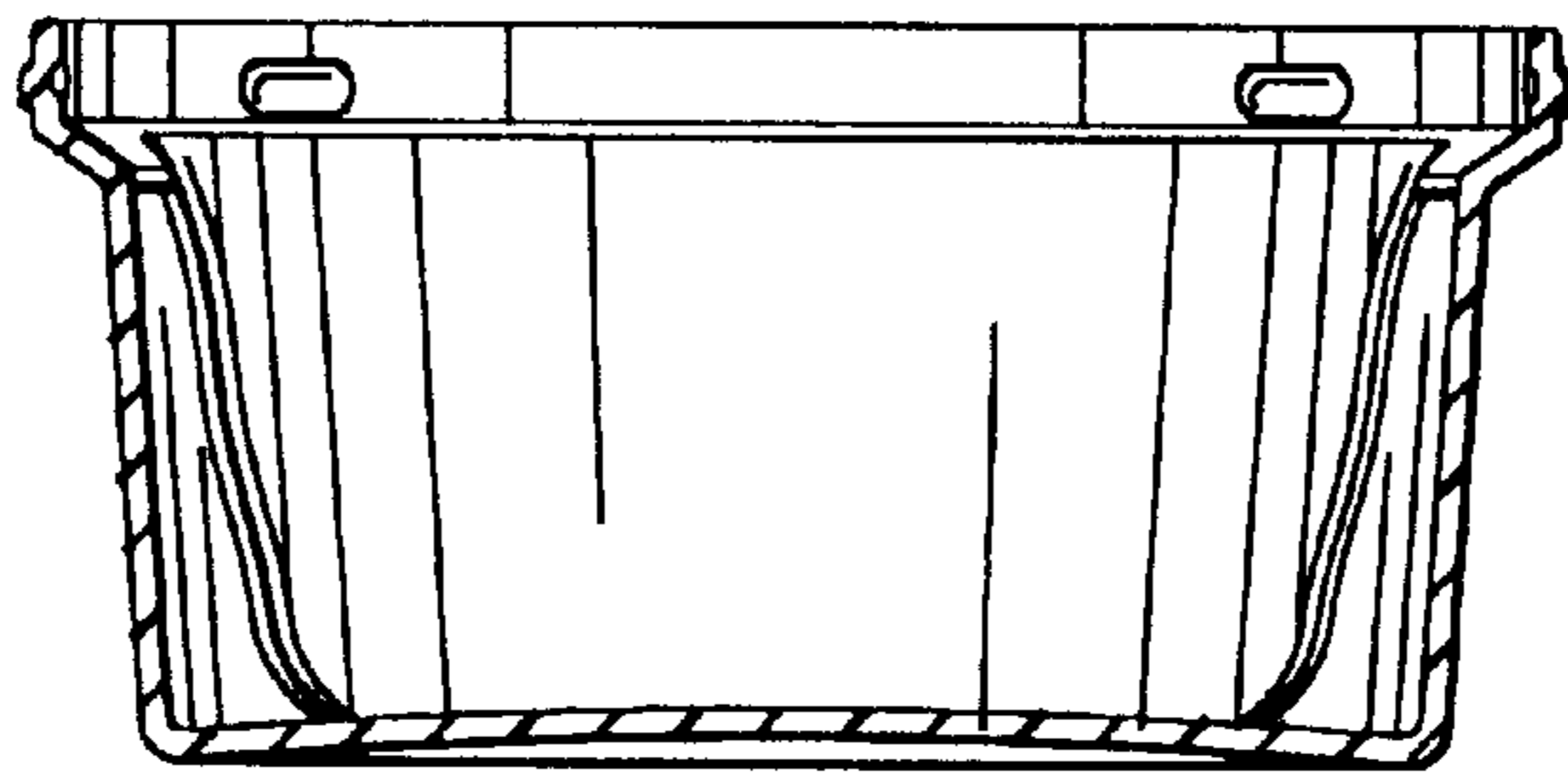

FIG. 9

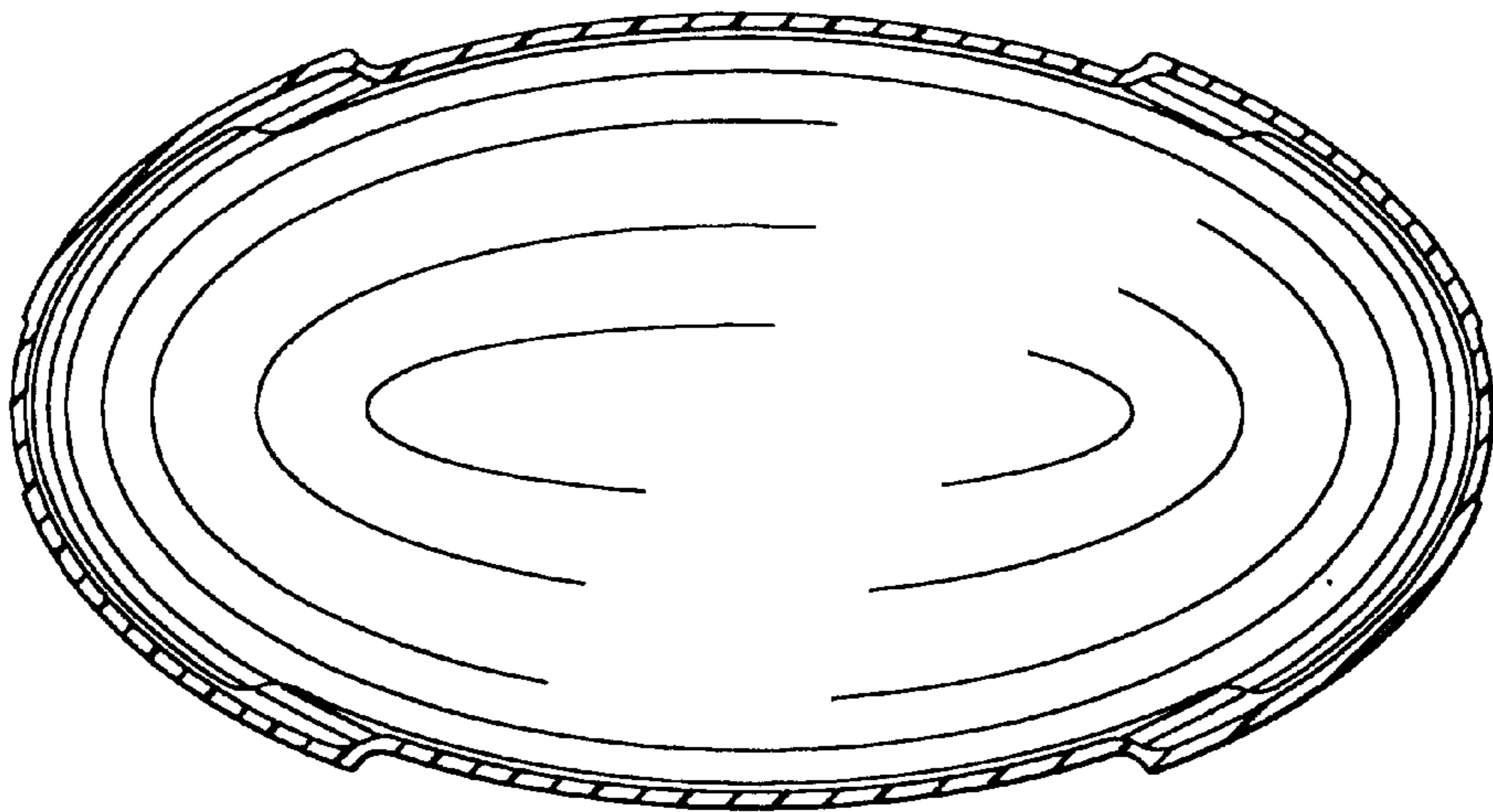

FIG. 10

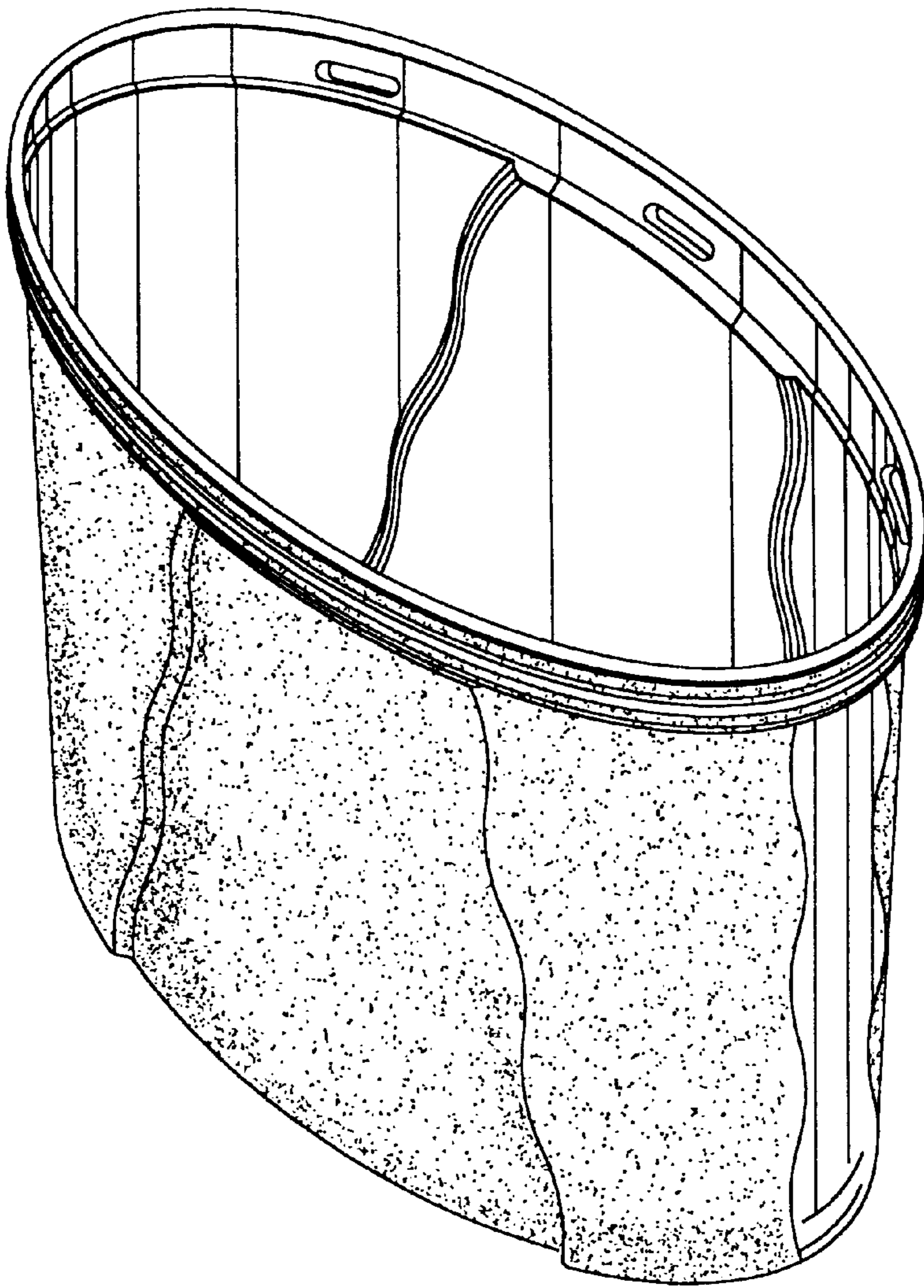

FIG. 11

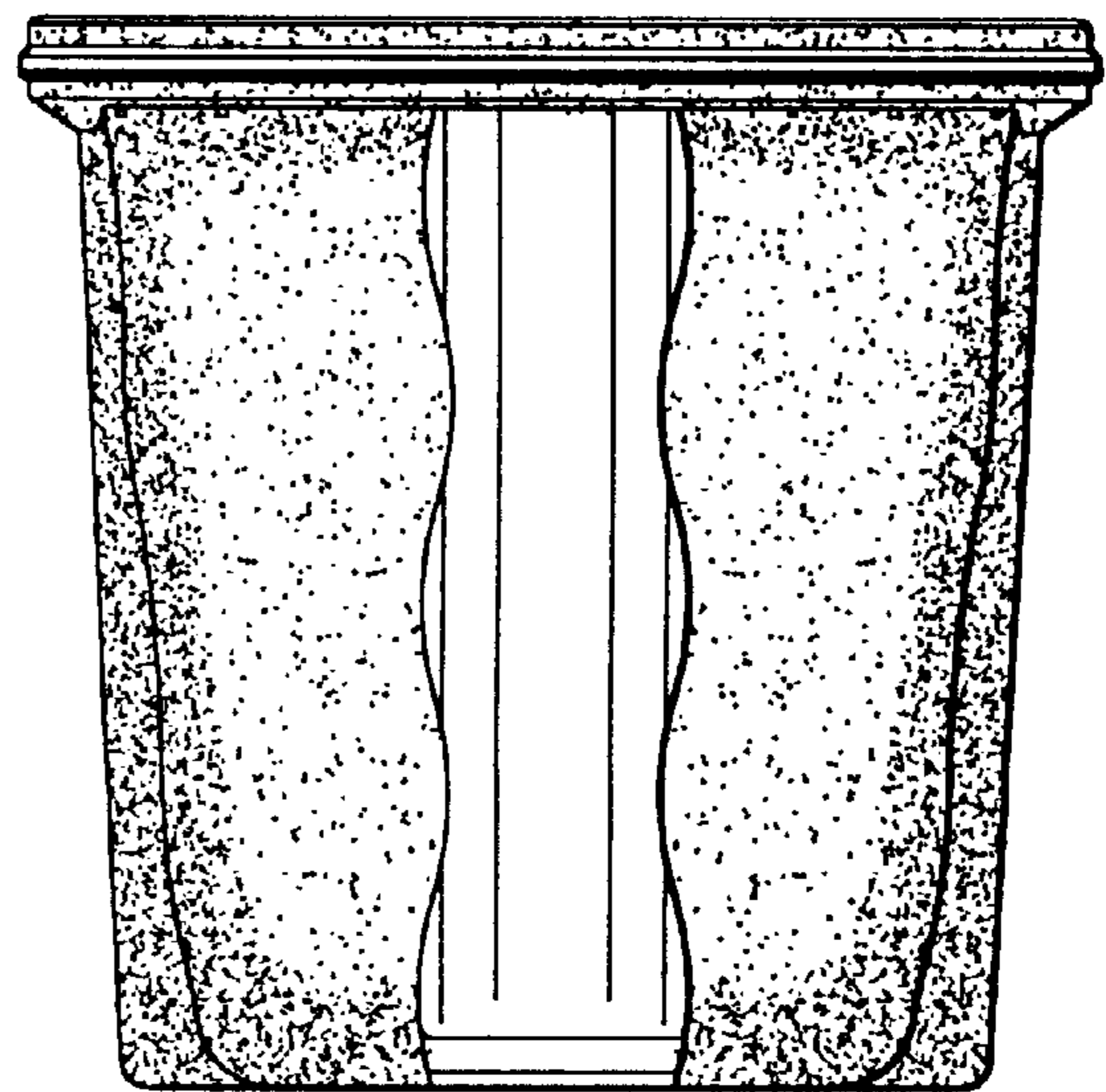

FIG. 12

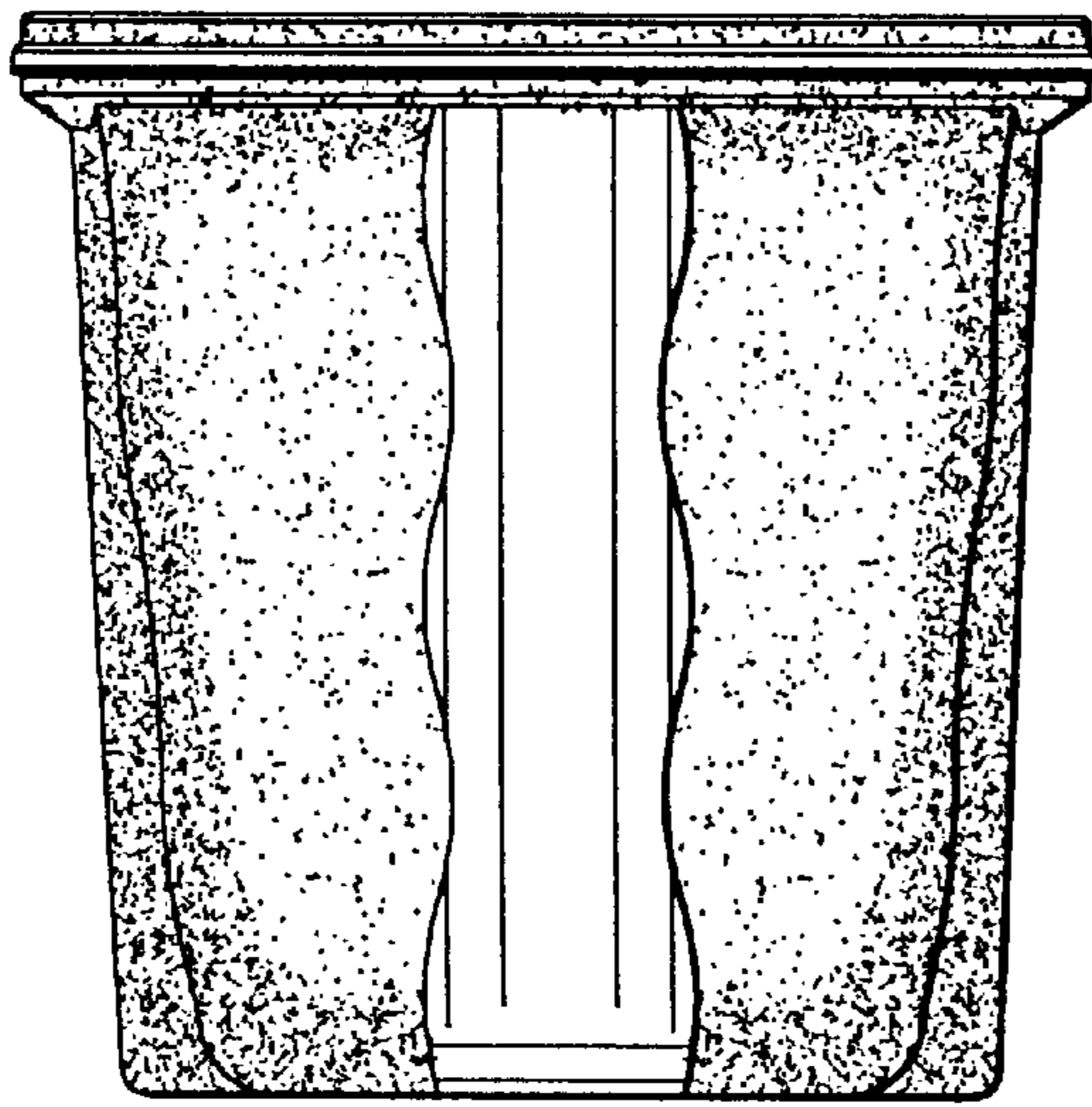

FIG. 13

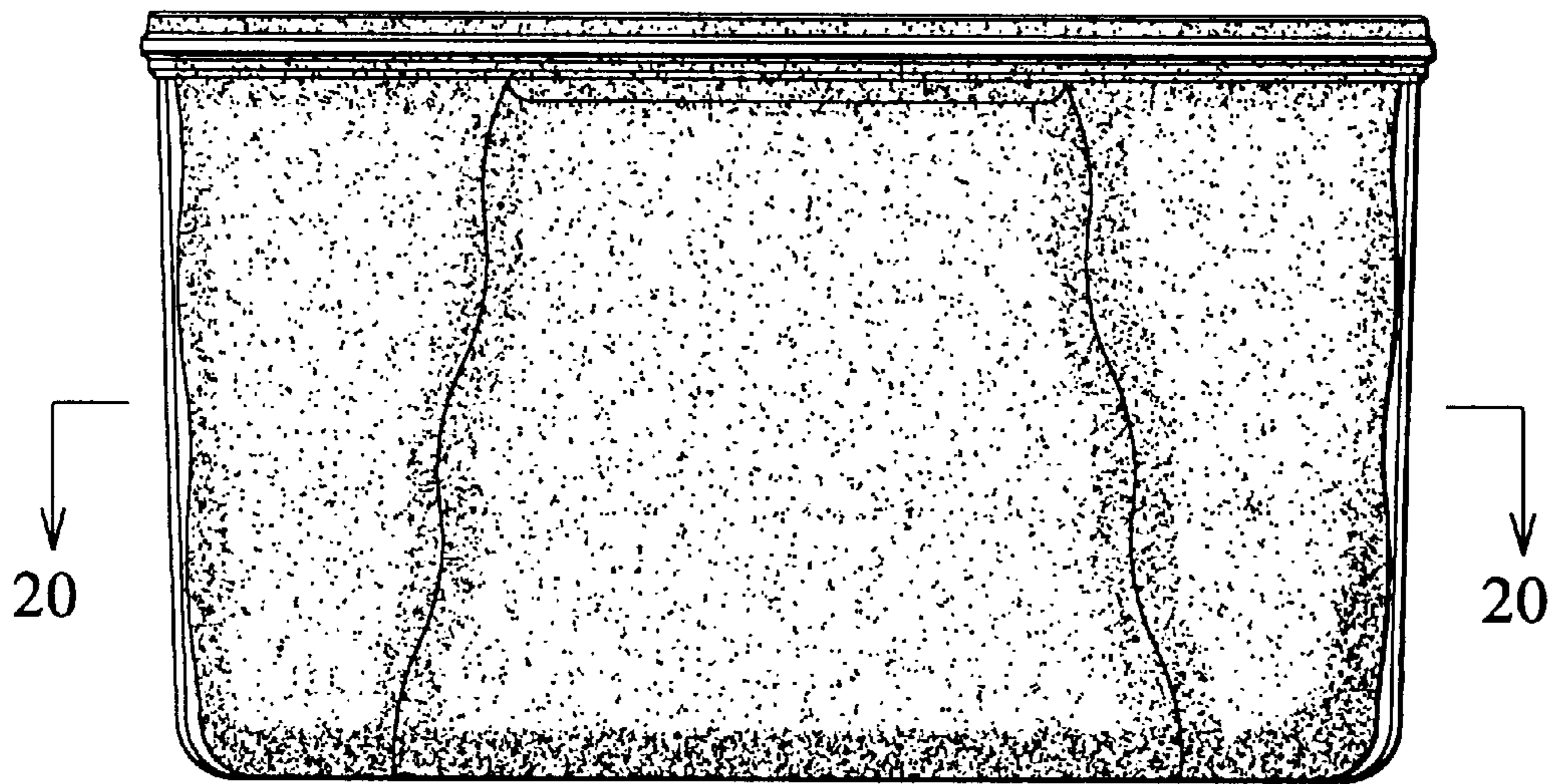

FIG. 14

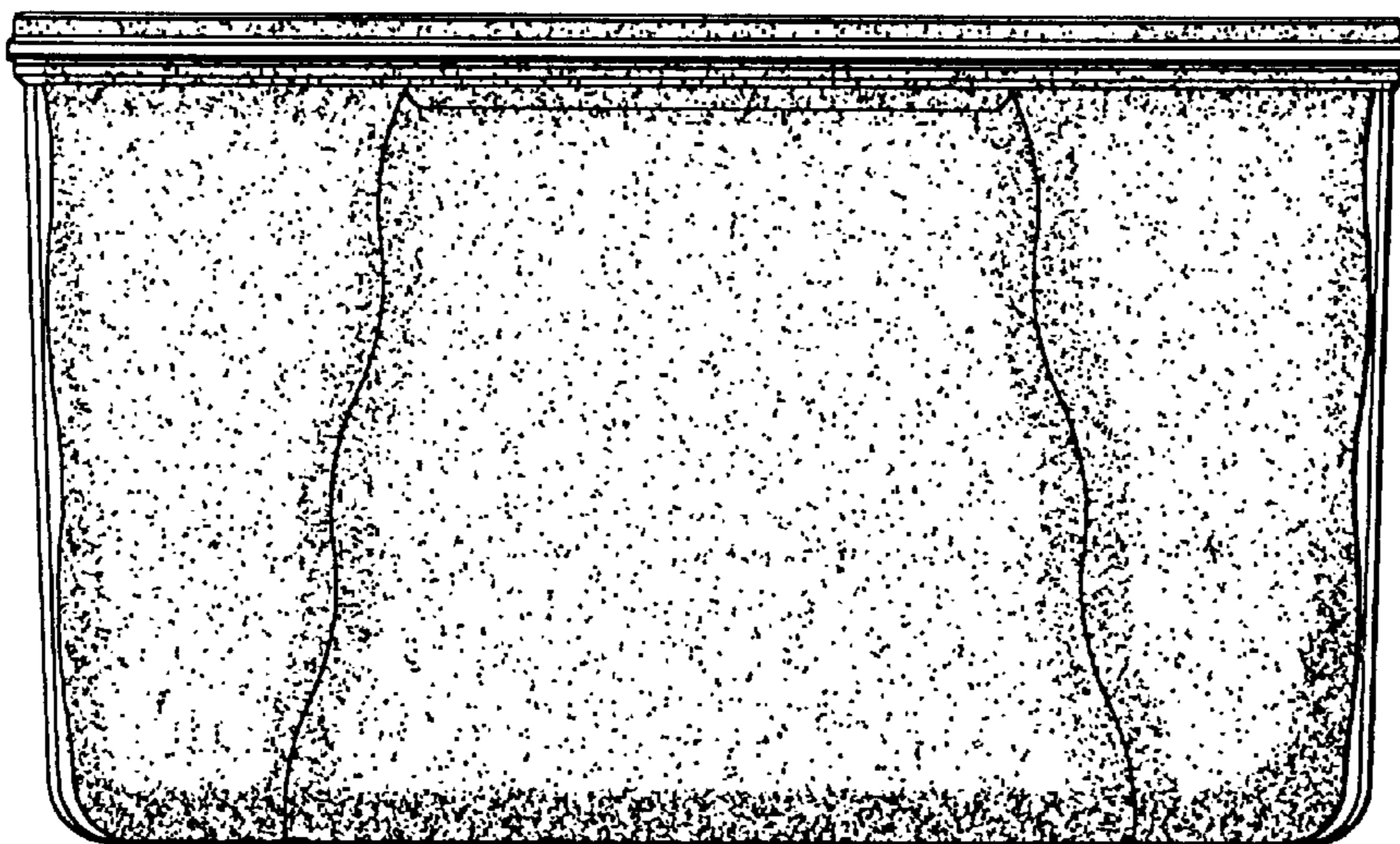

FIG. 15

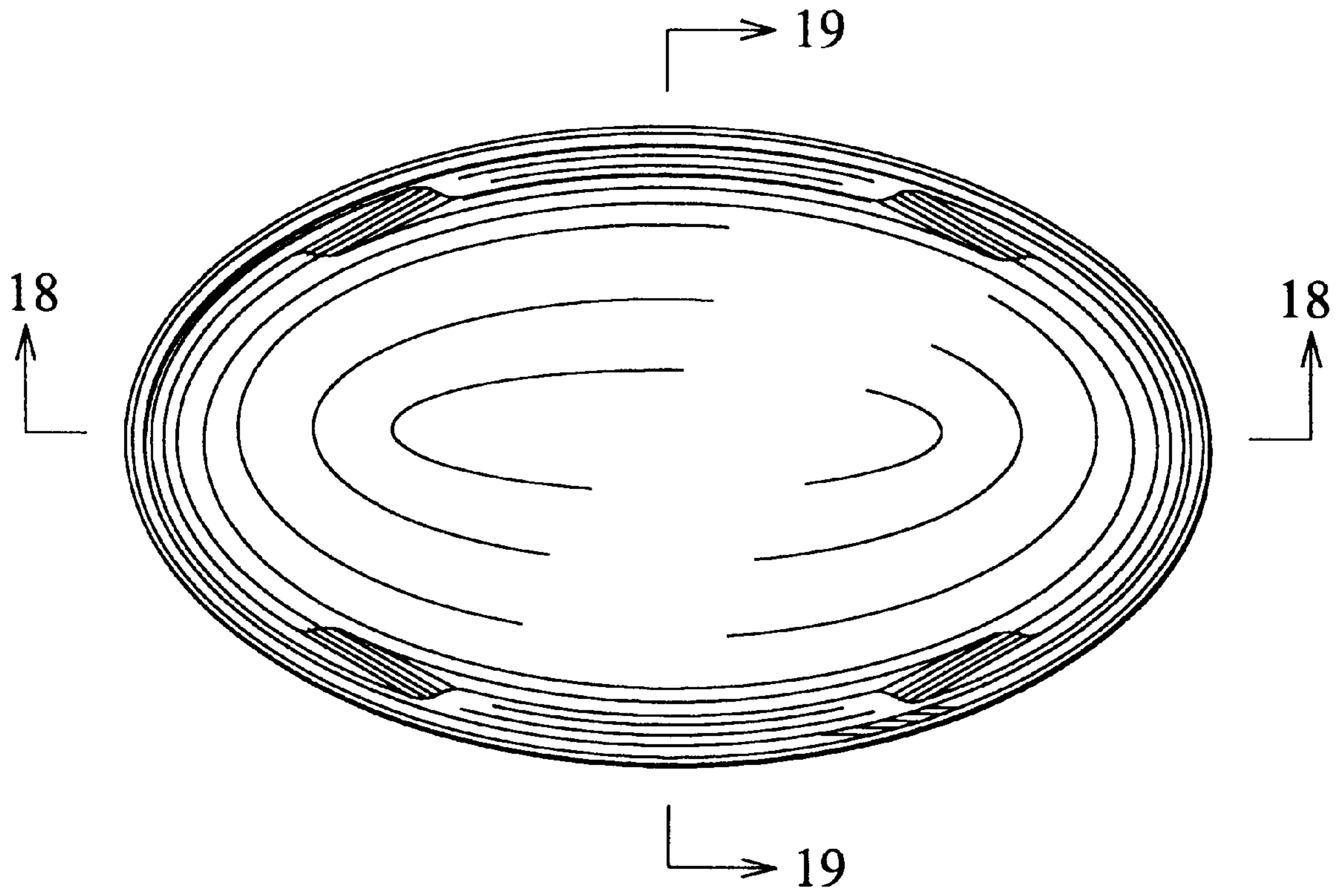

FIG. 16

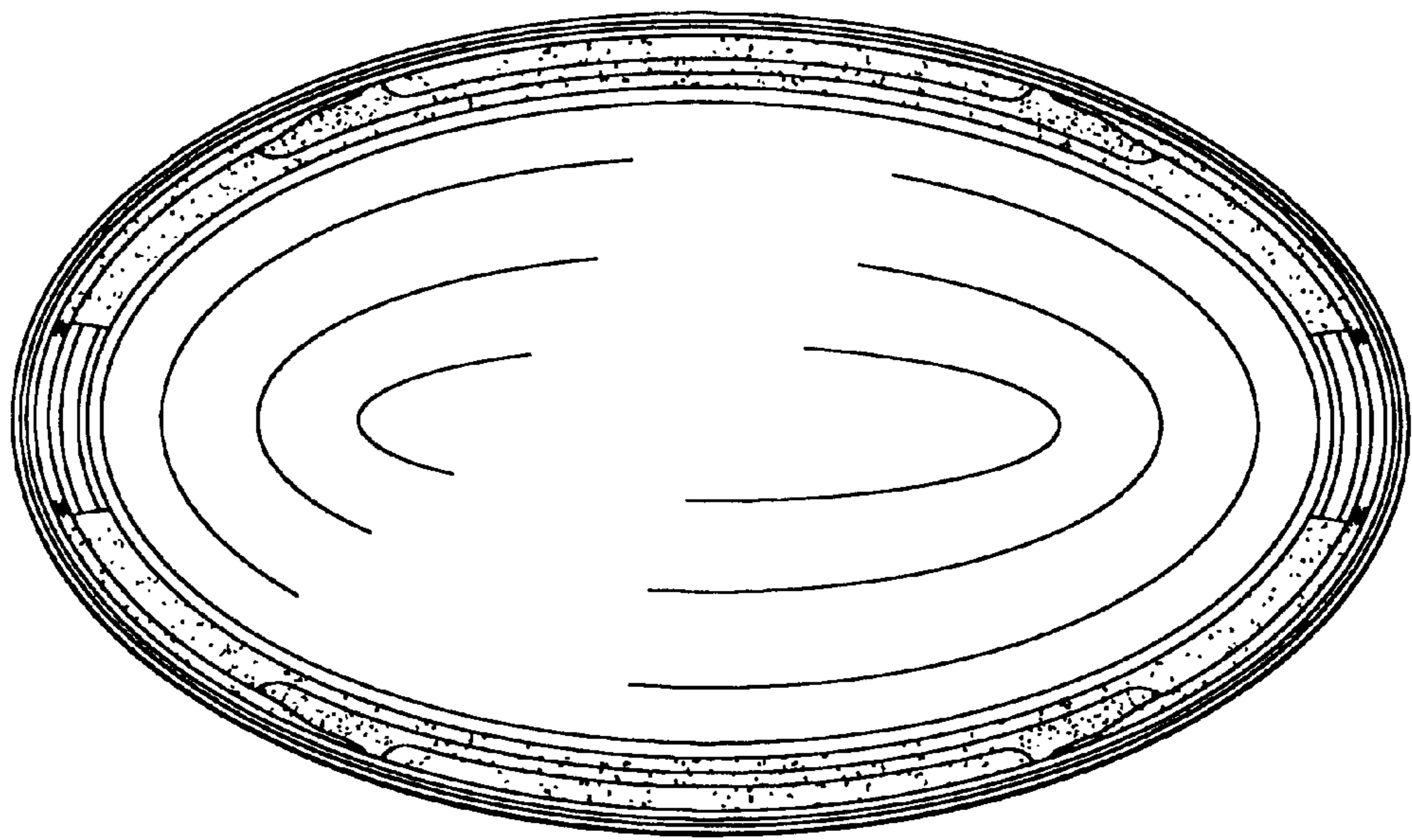

FIG. 17

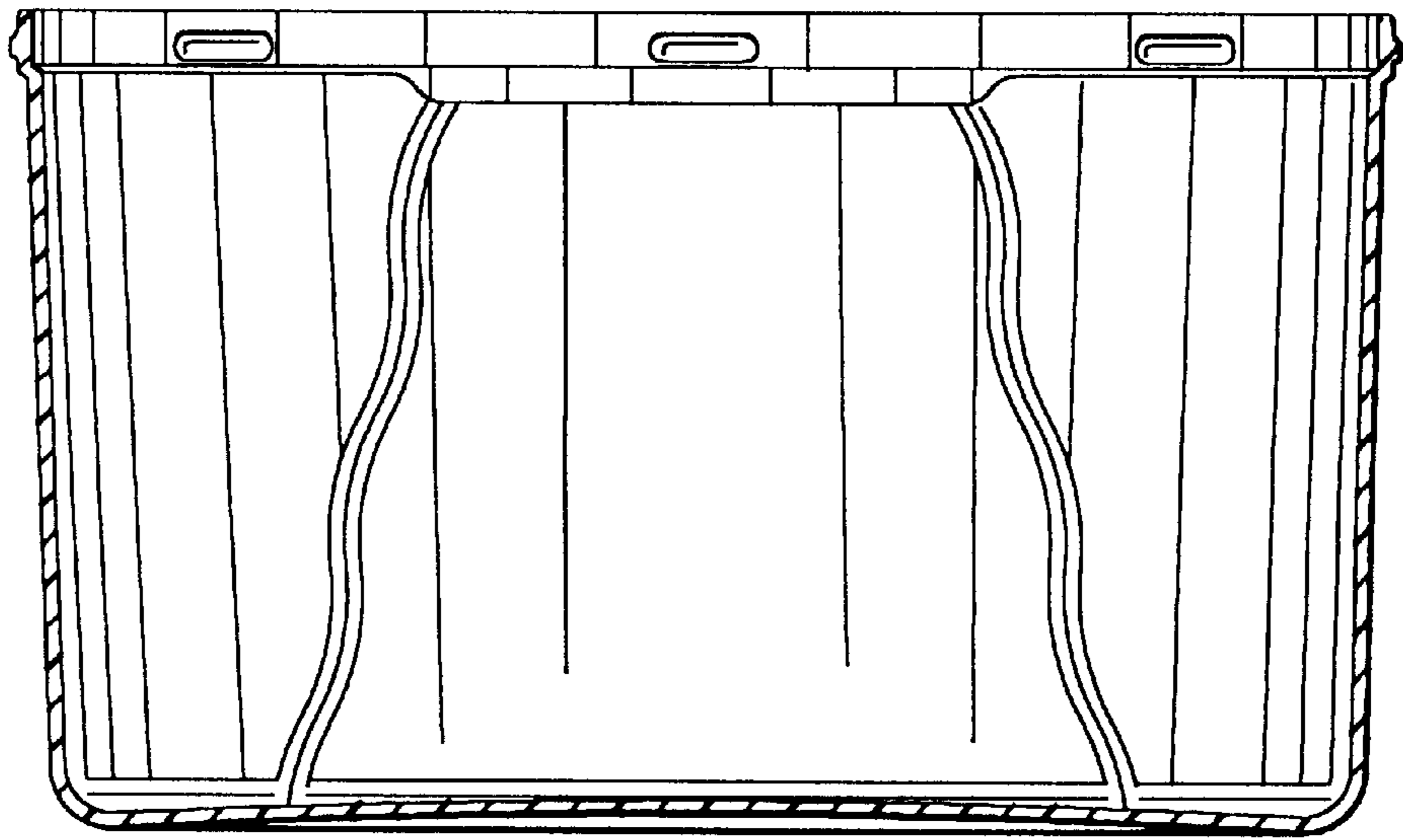

FIG. 18

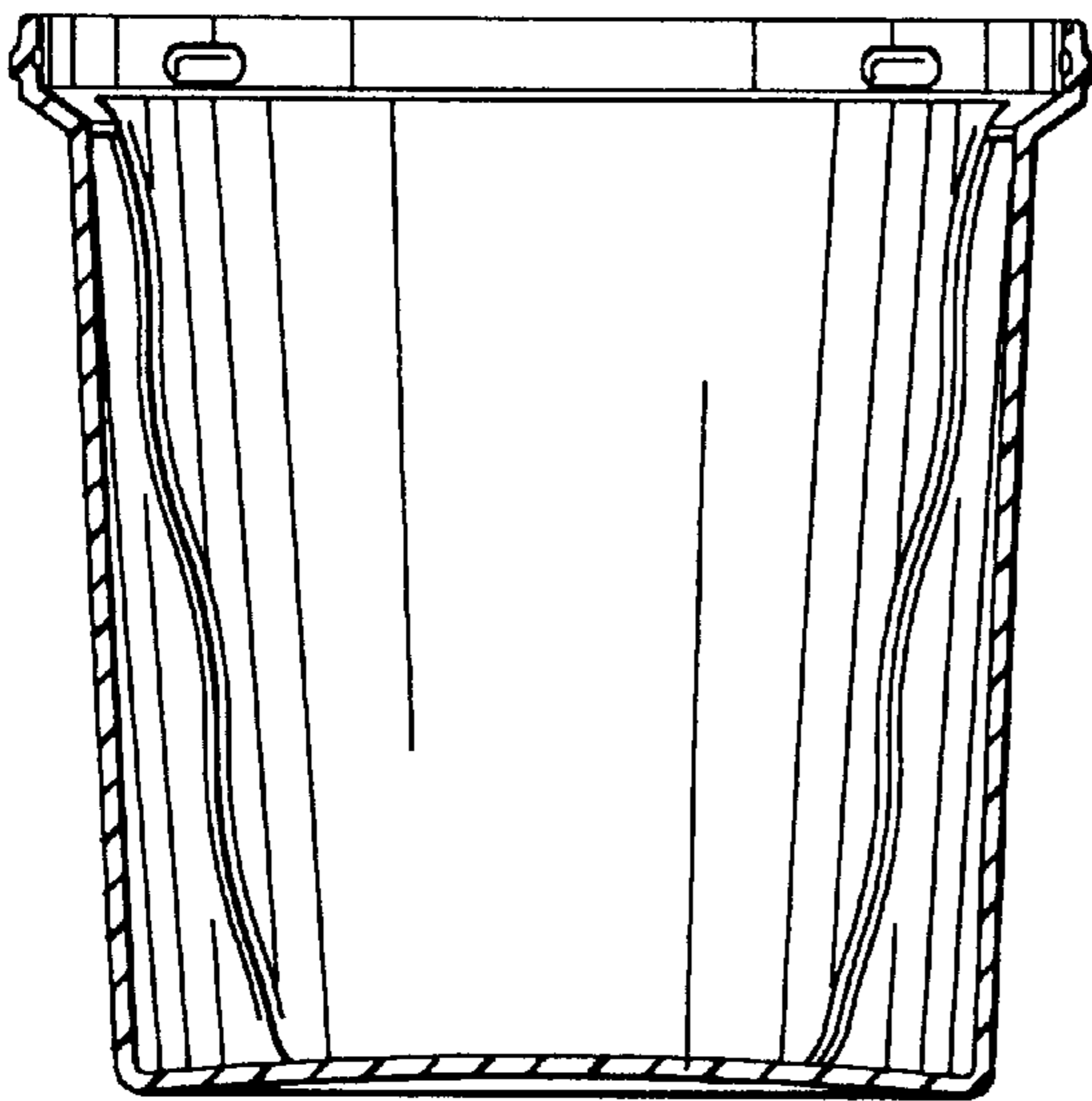

FIG. 19

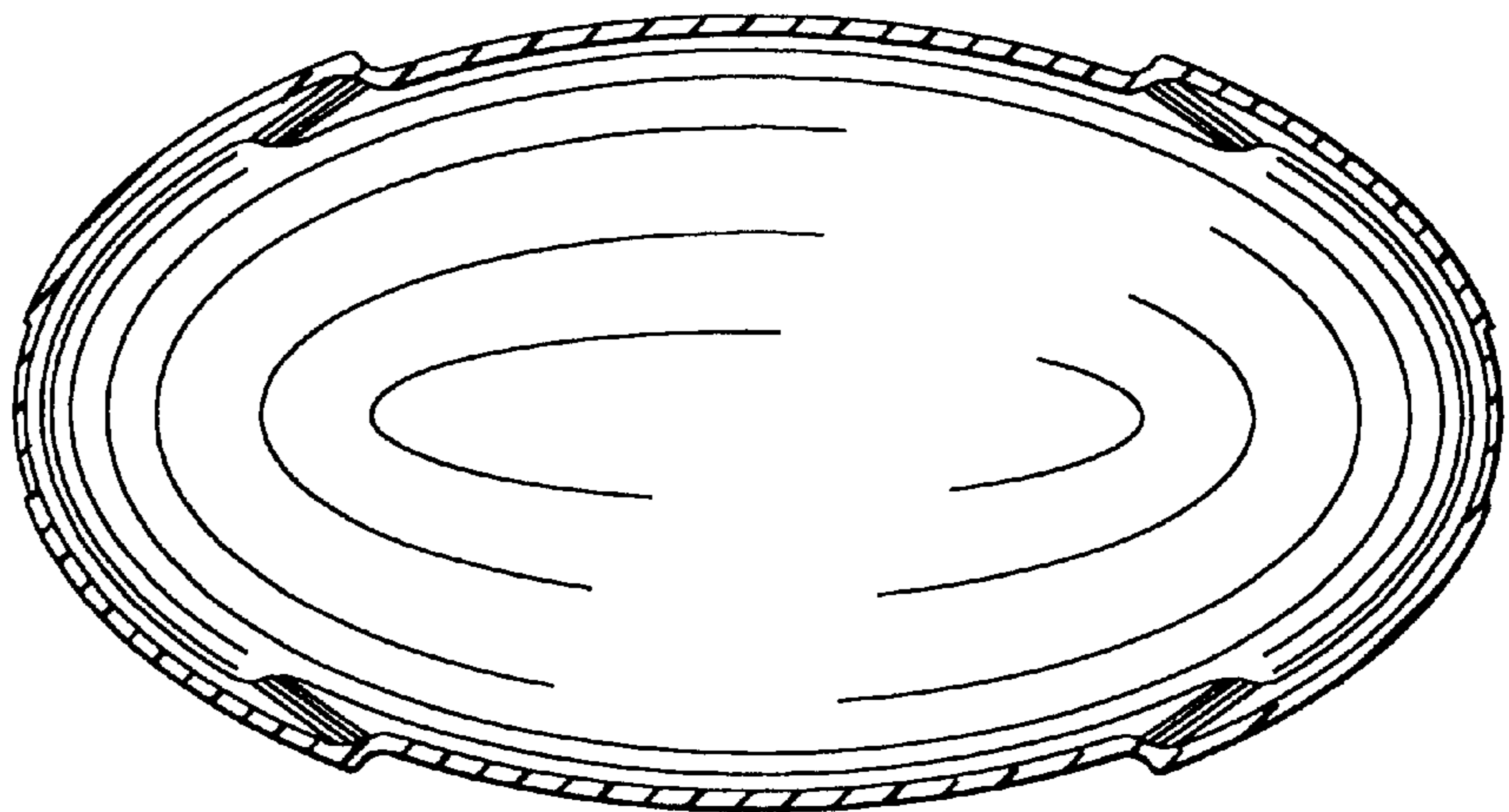

FIG. 20

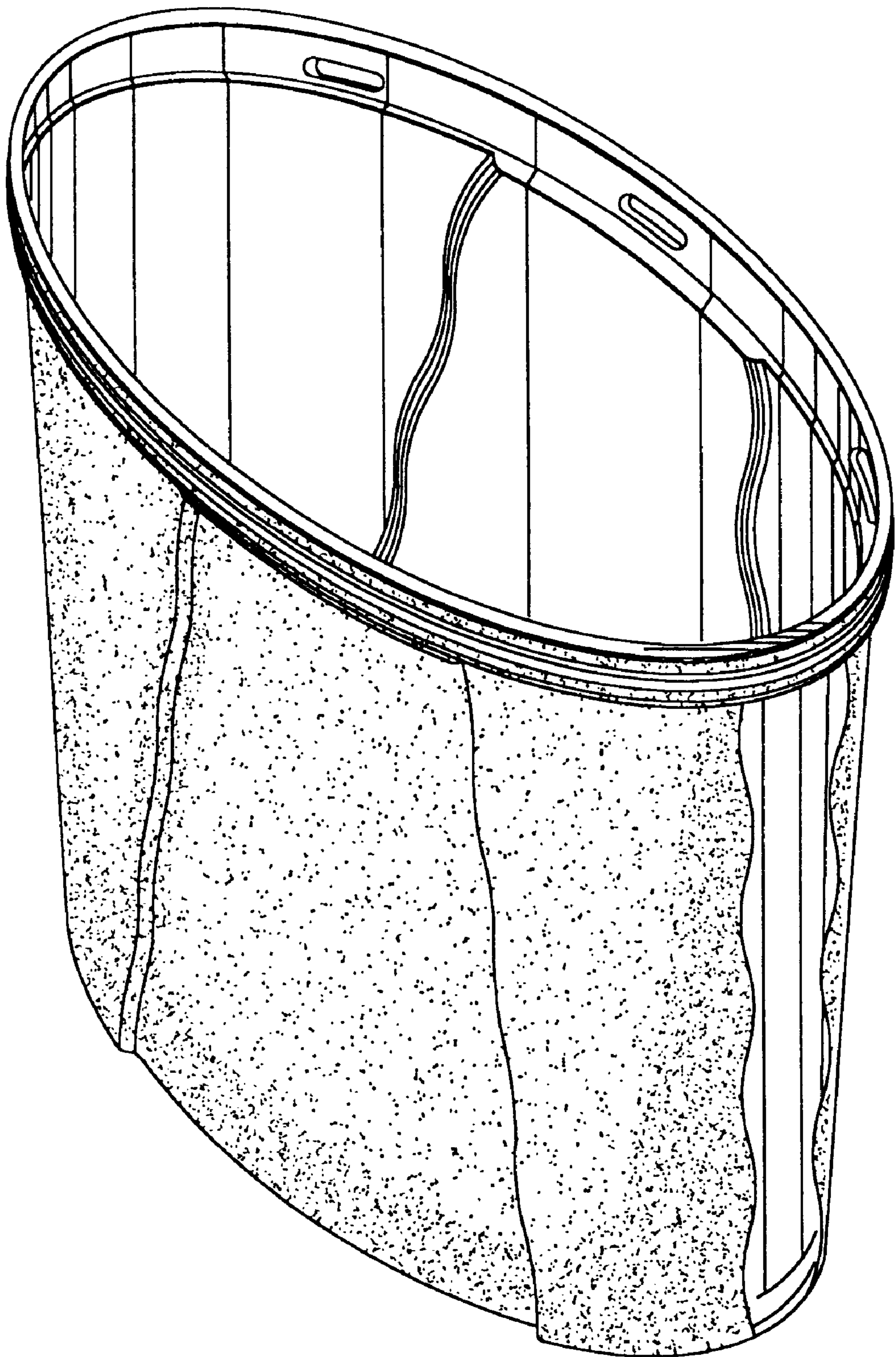

FIG. 21

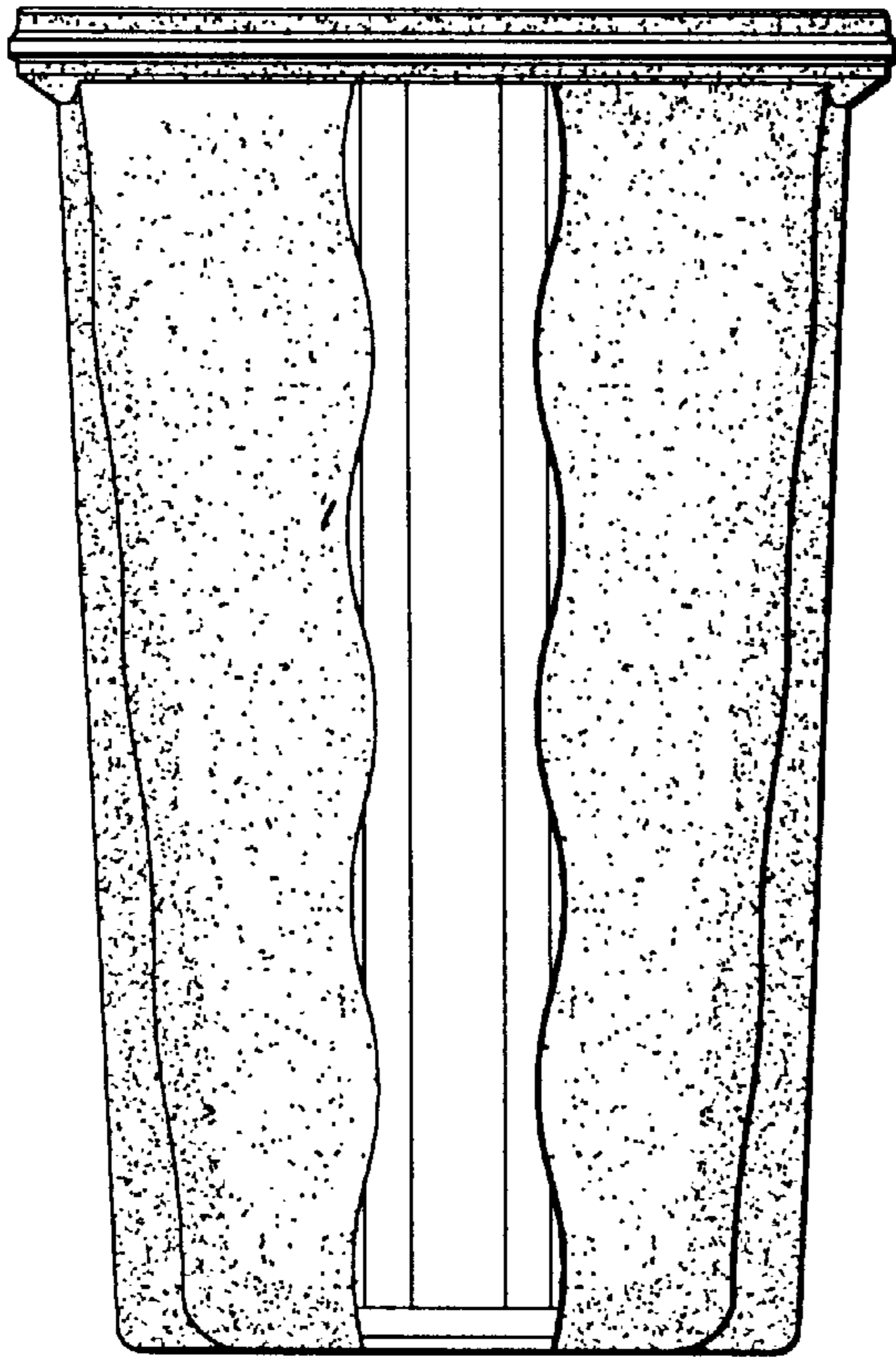

FIG. 22

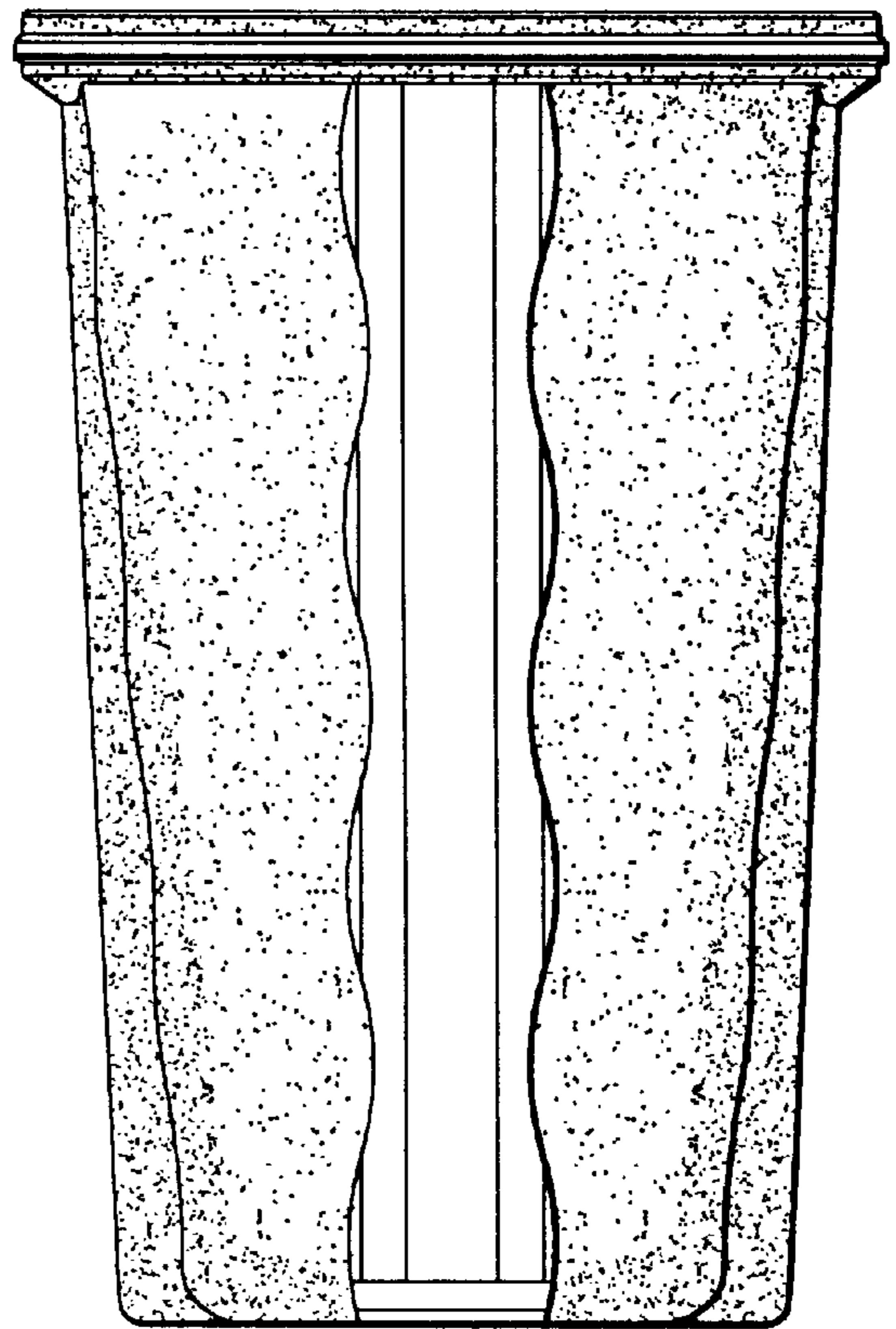

FIG. 23

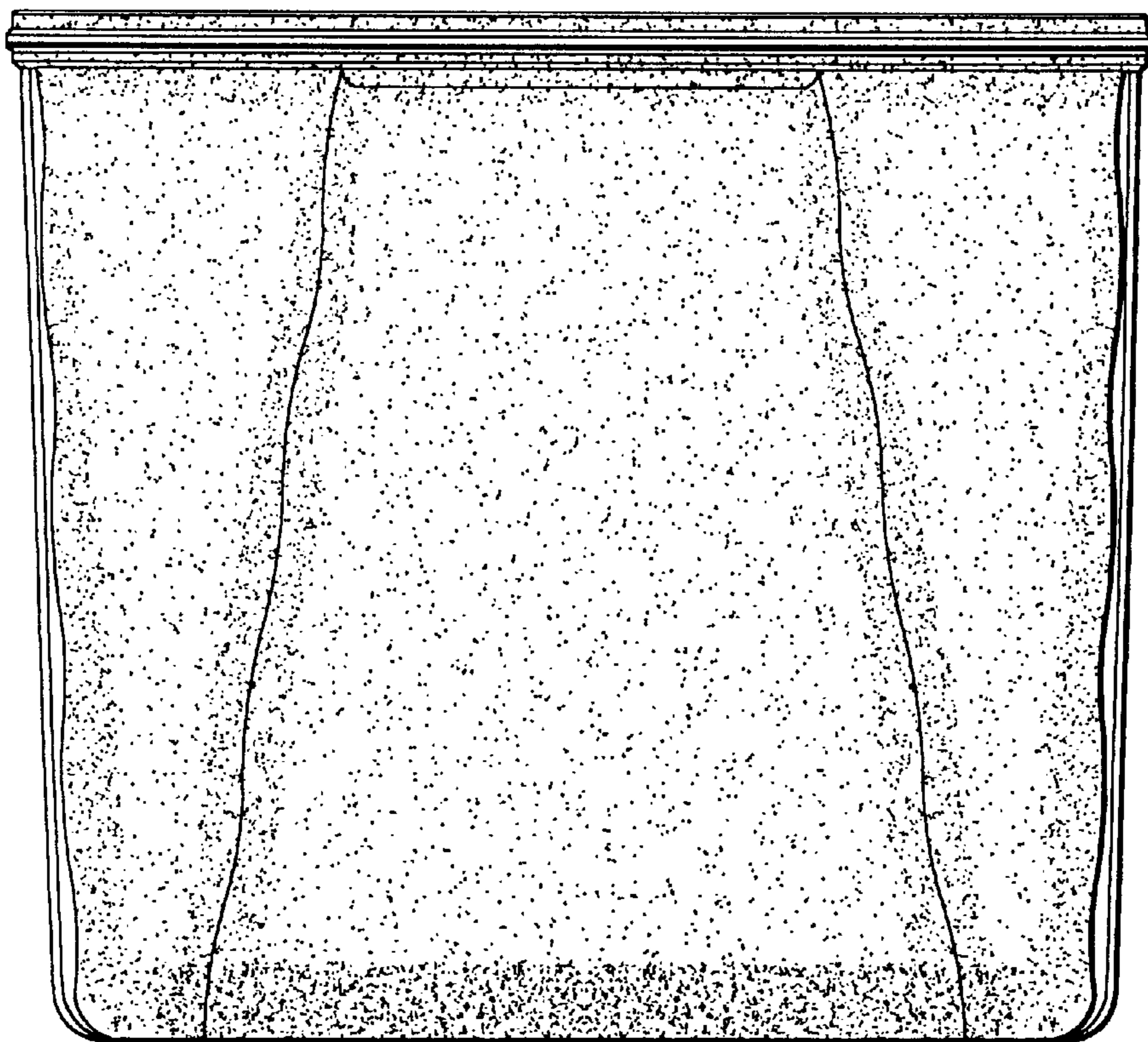

FIG. 24

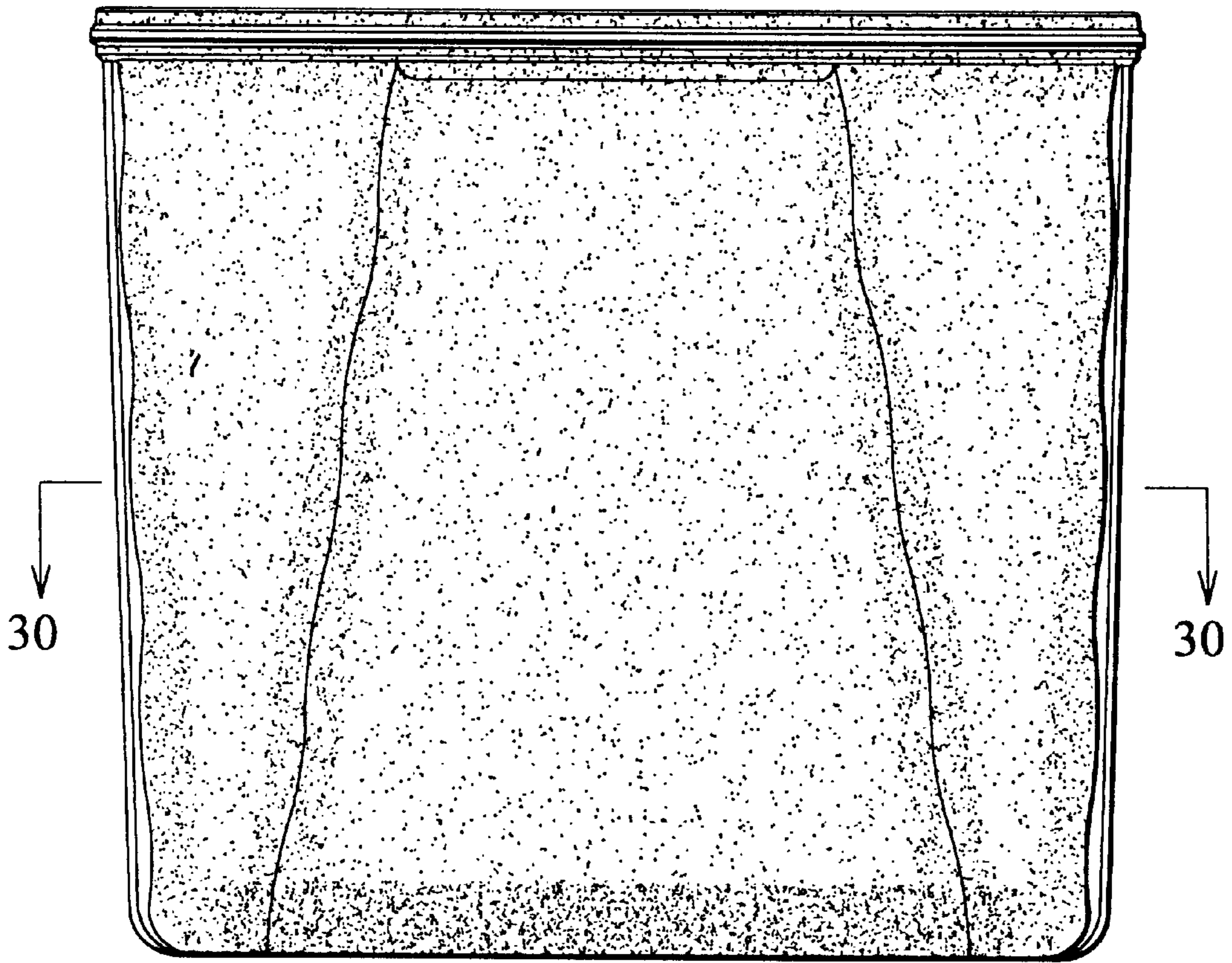

FIG. 25

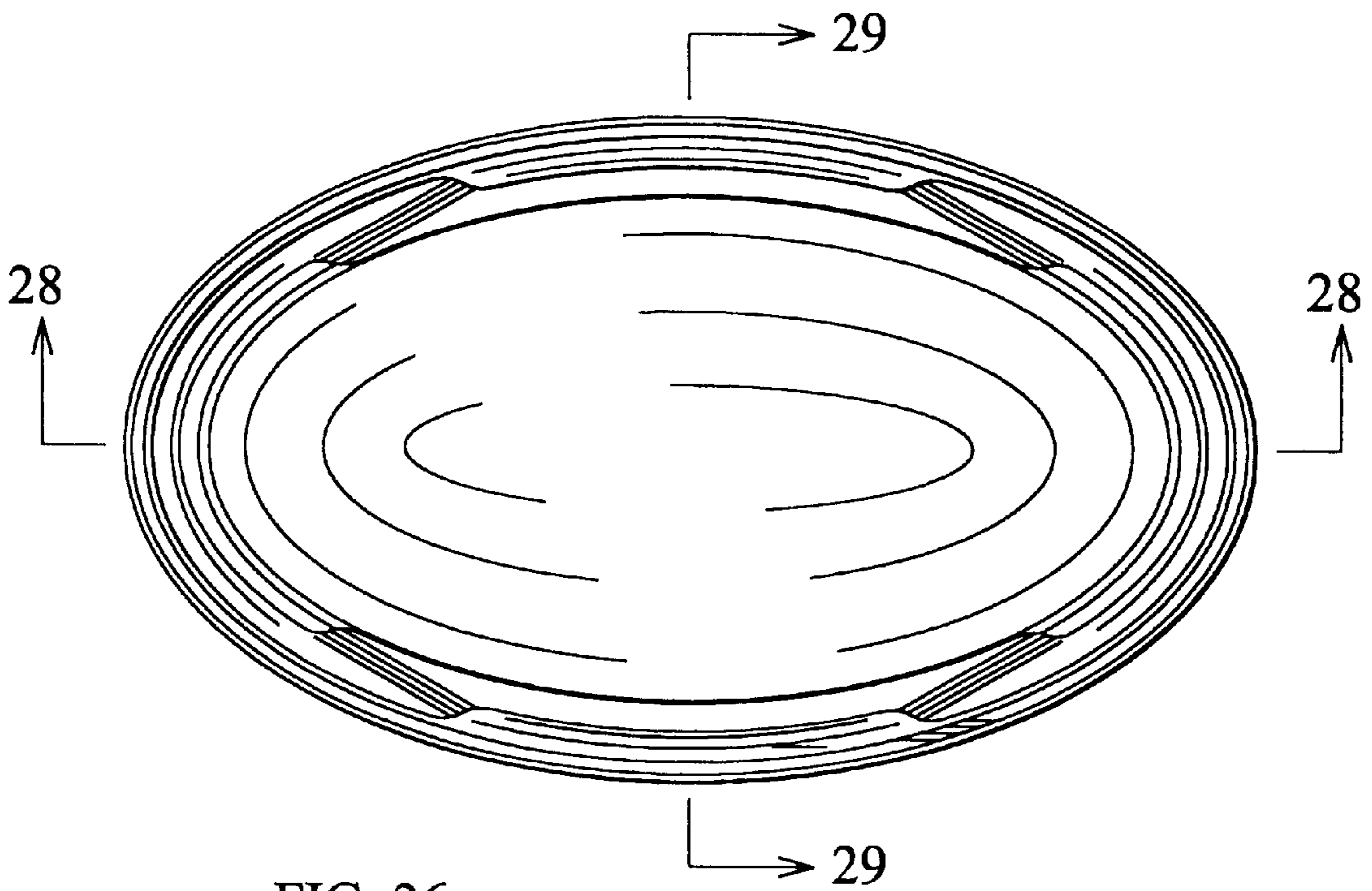

FIG. 26

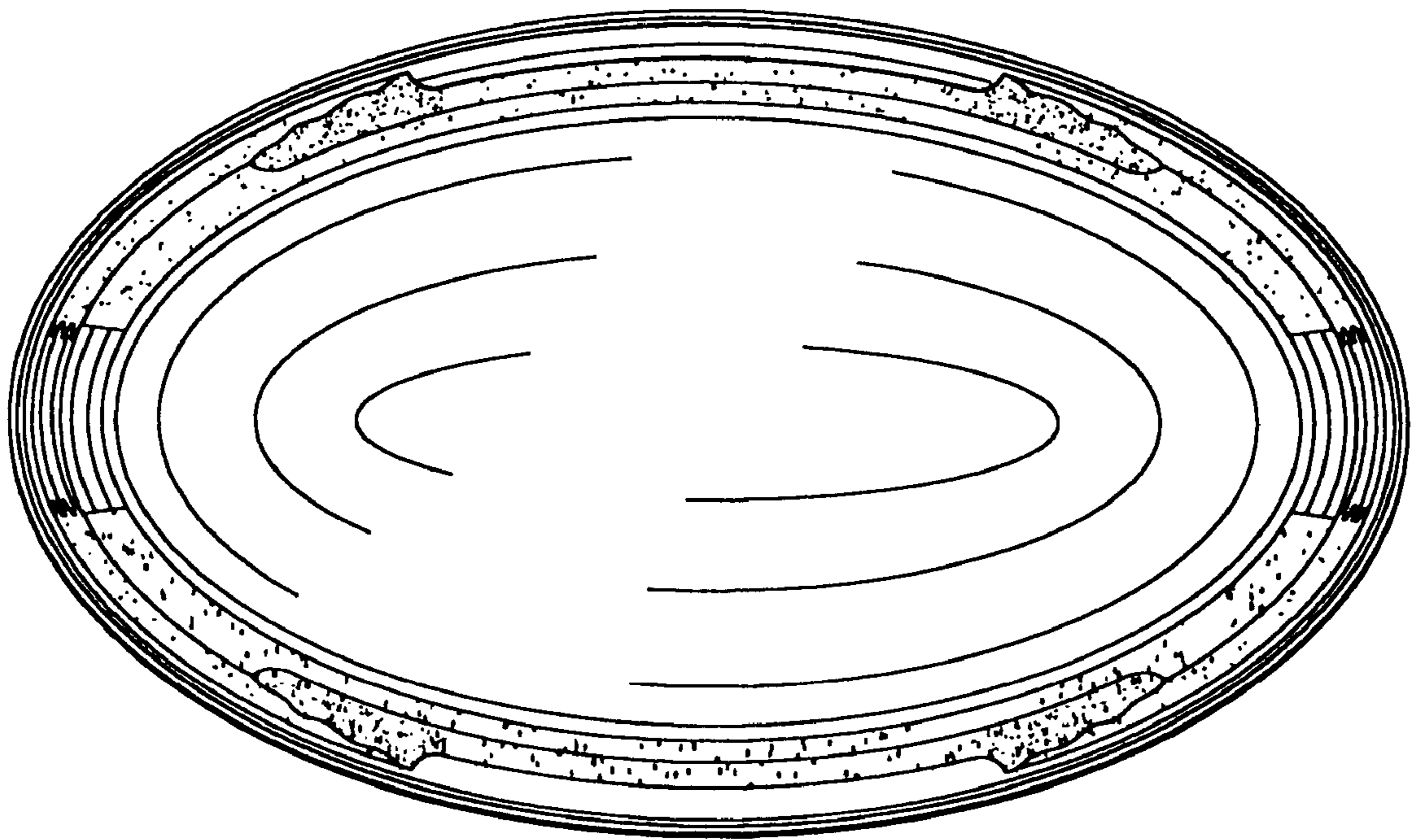

FIG. 27

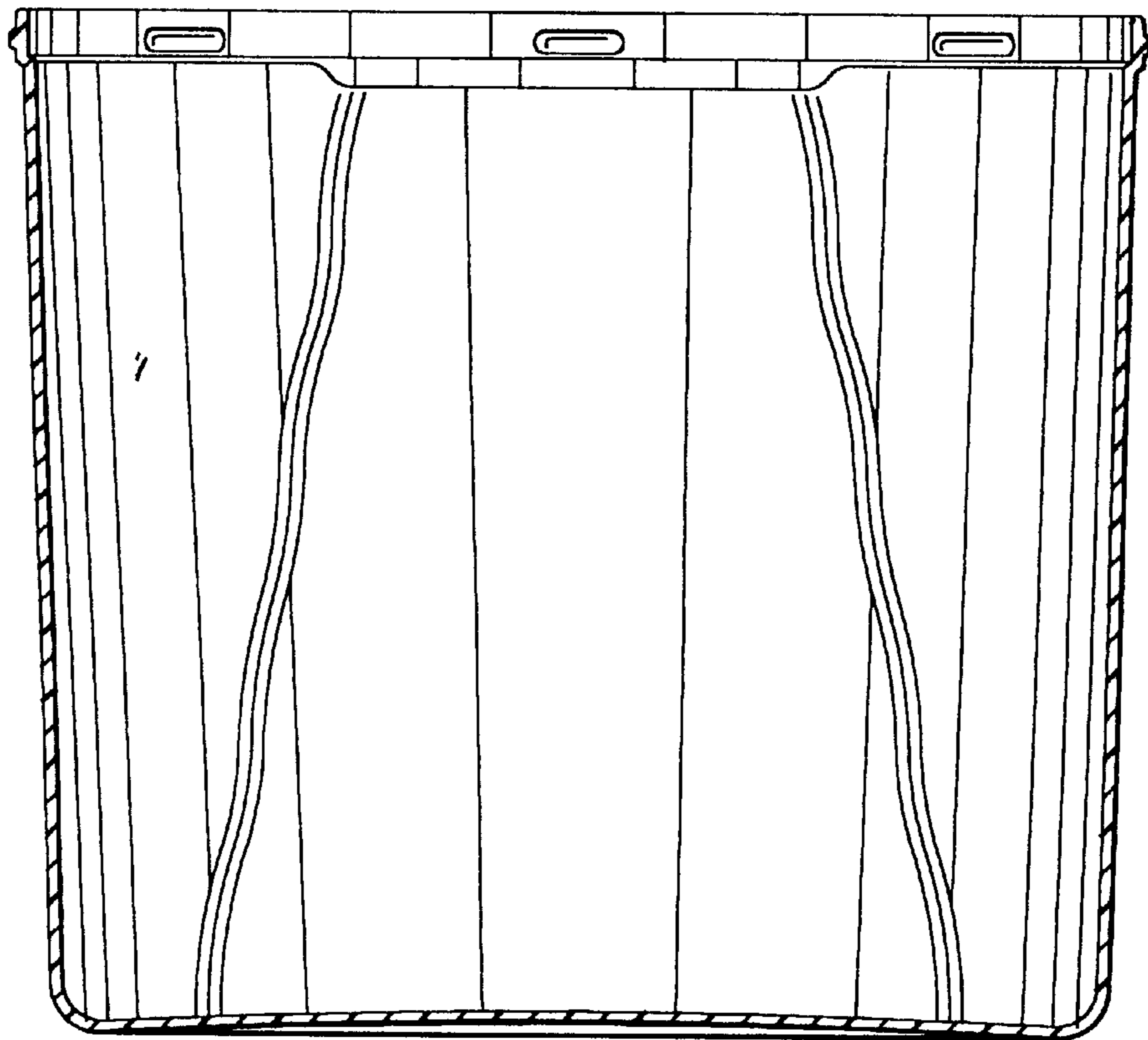

FIG. 28

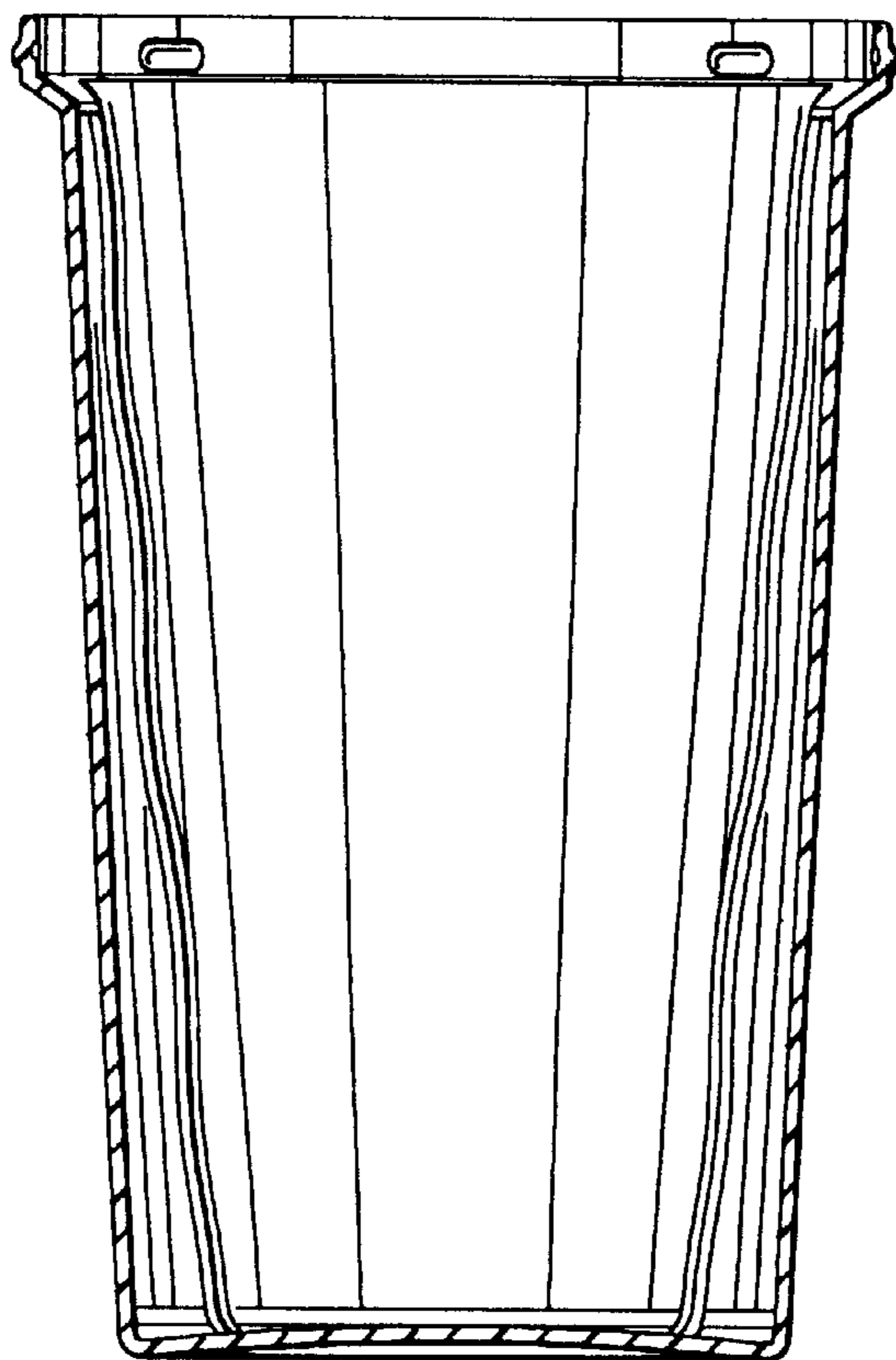

FIG. 29

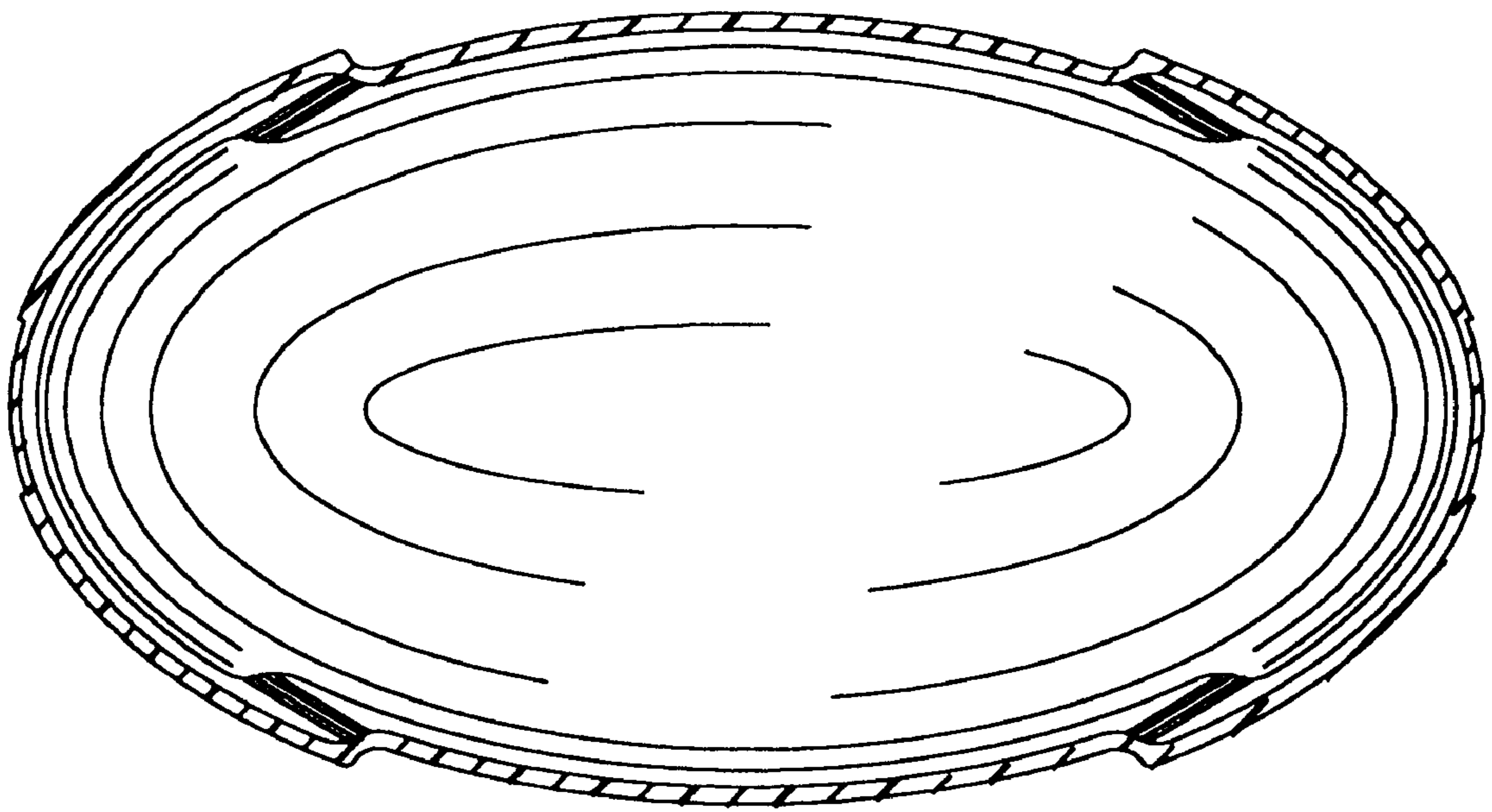

FIG. 30

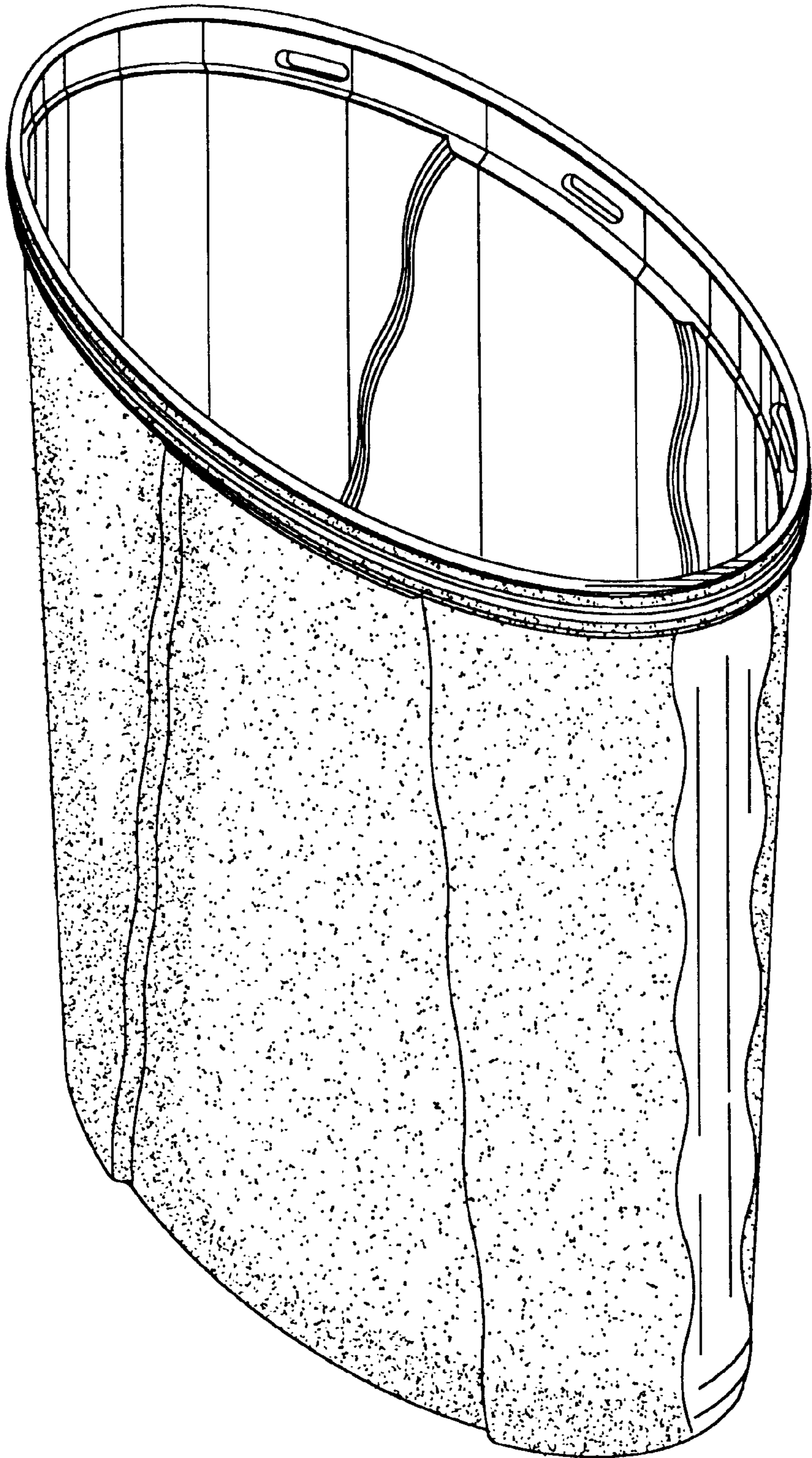

FIG. 31

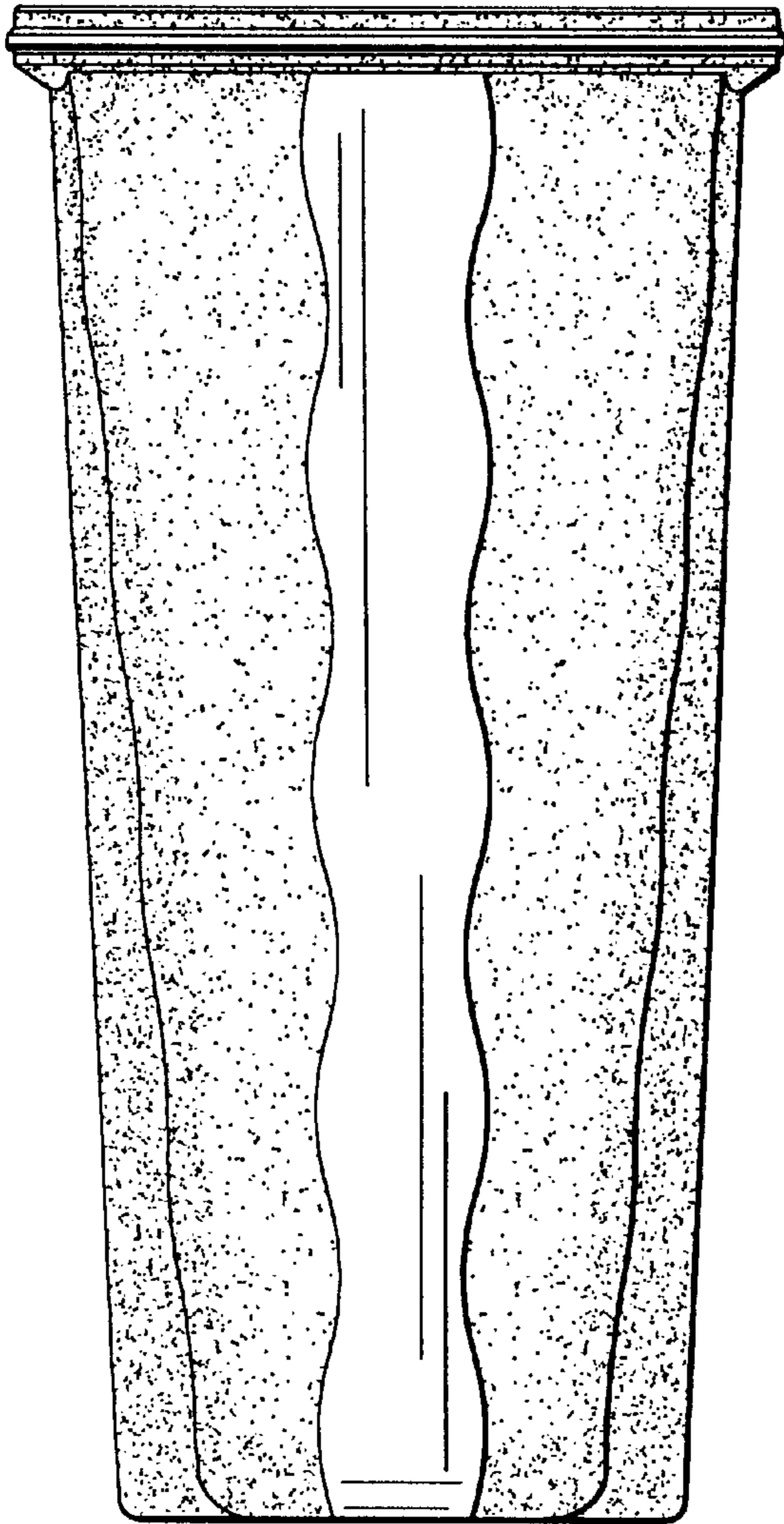

FIG. 32

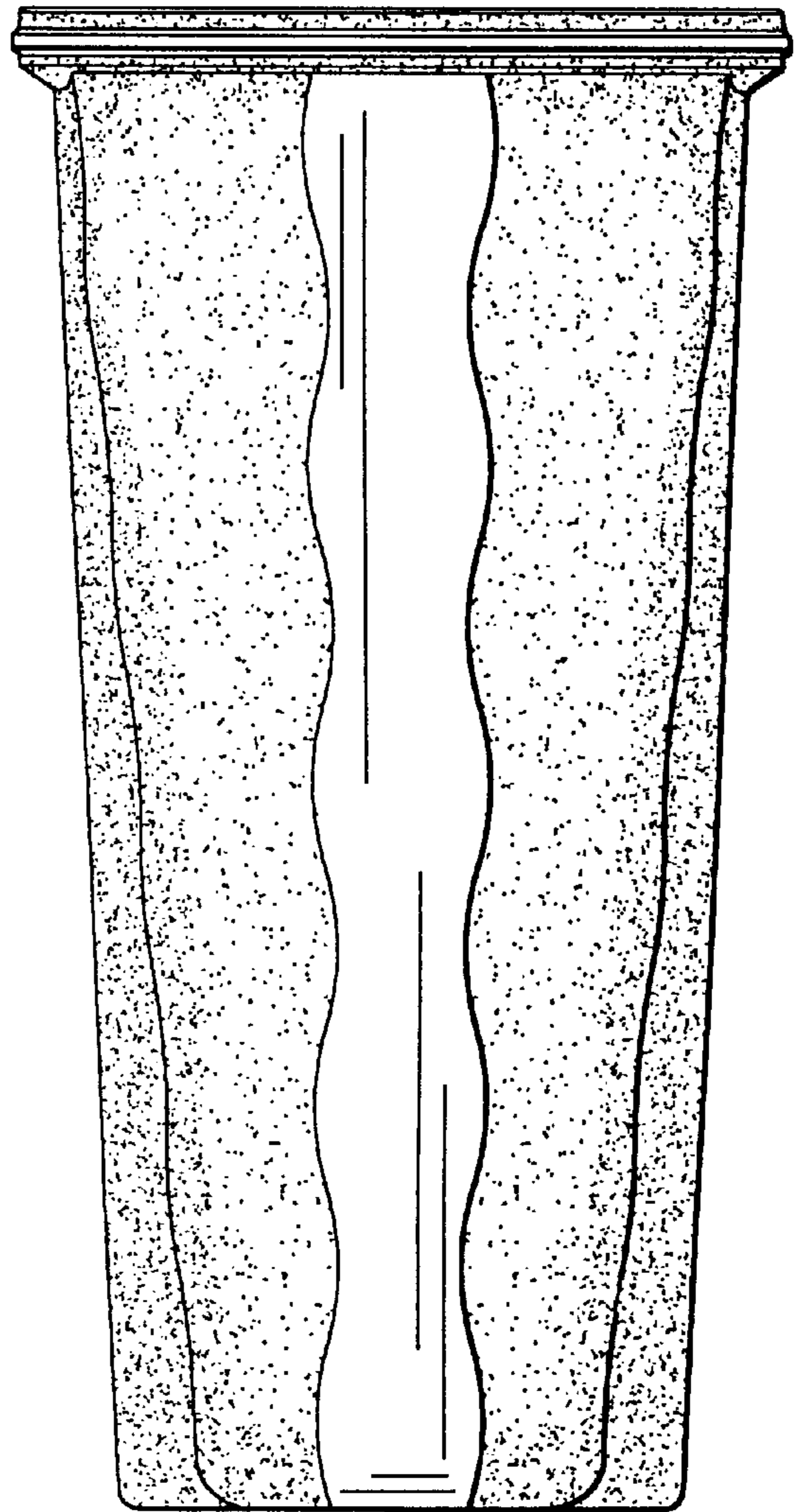

FIG. 33

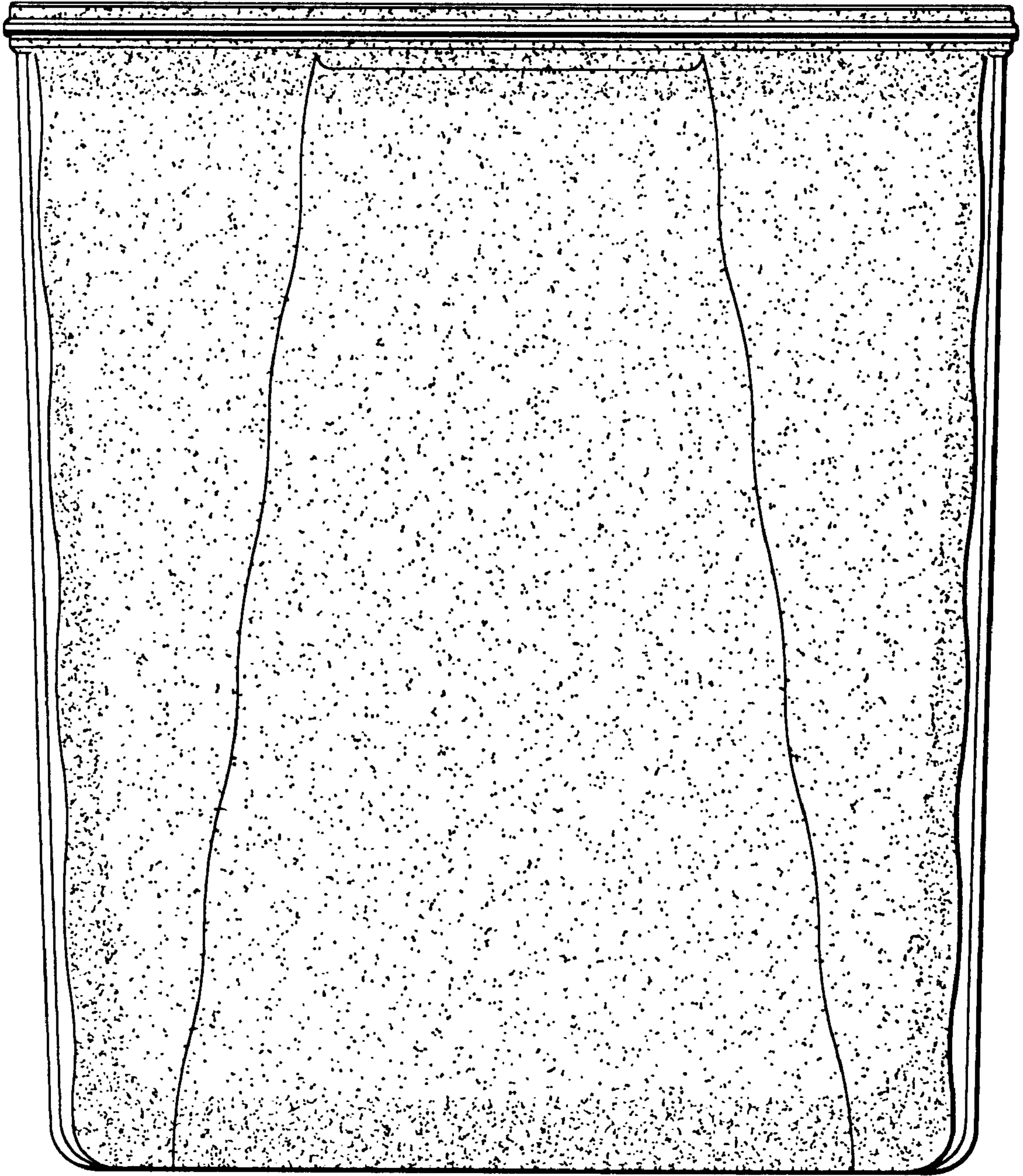

FIG. 34

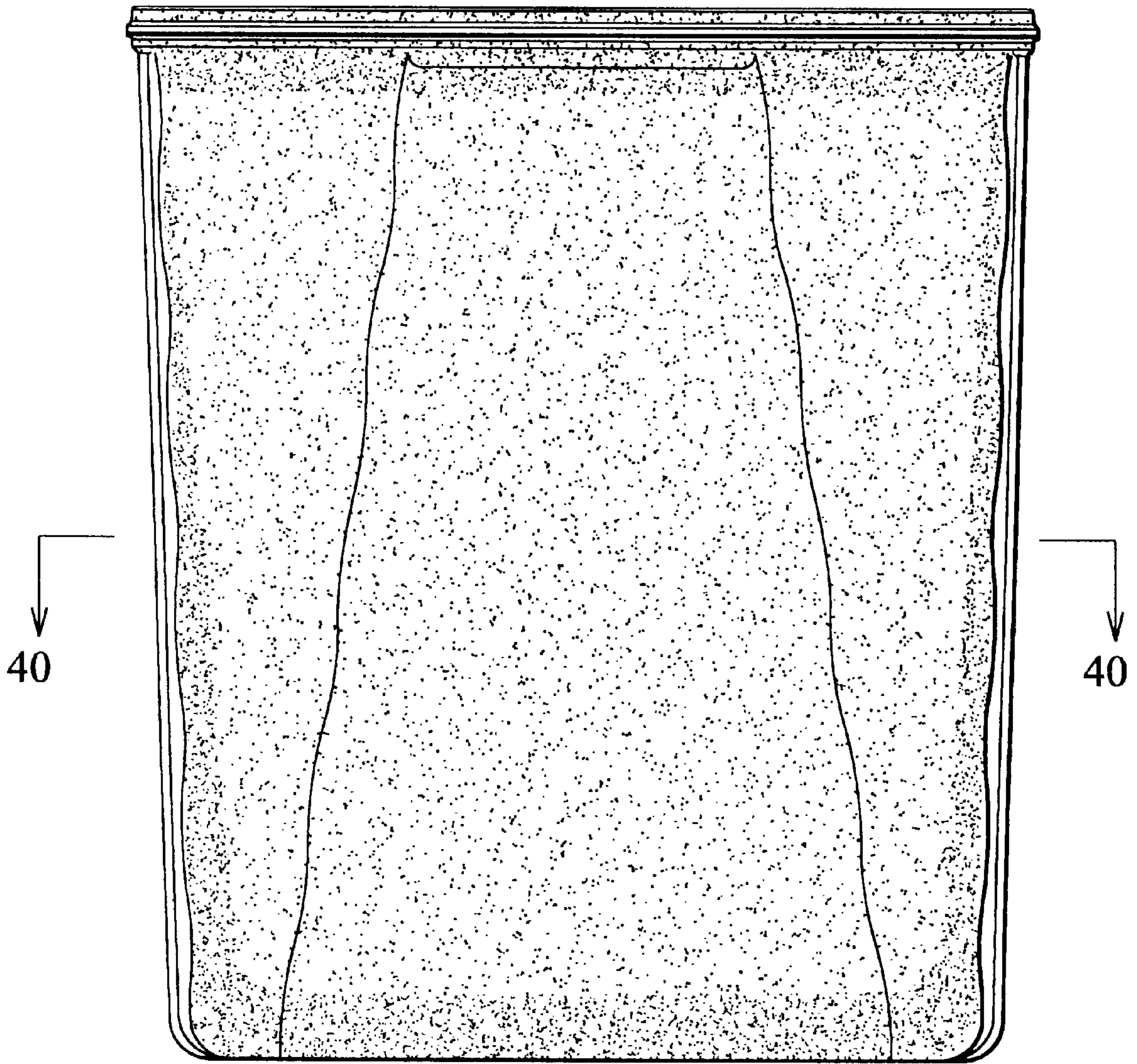

FIG. 35

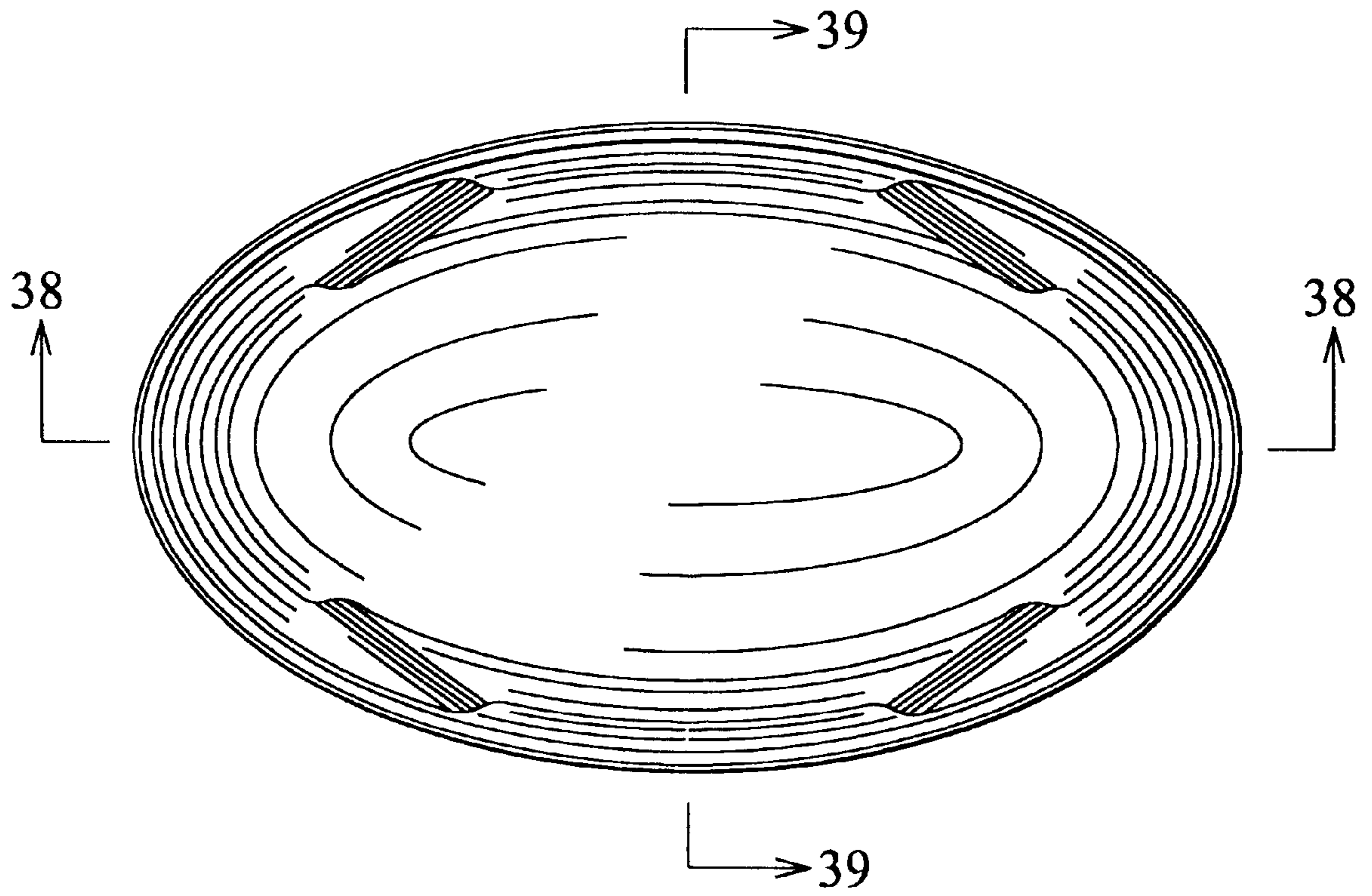

FIG. 36

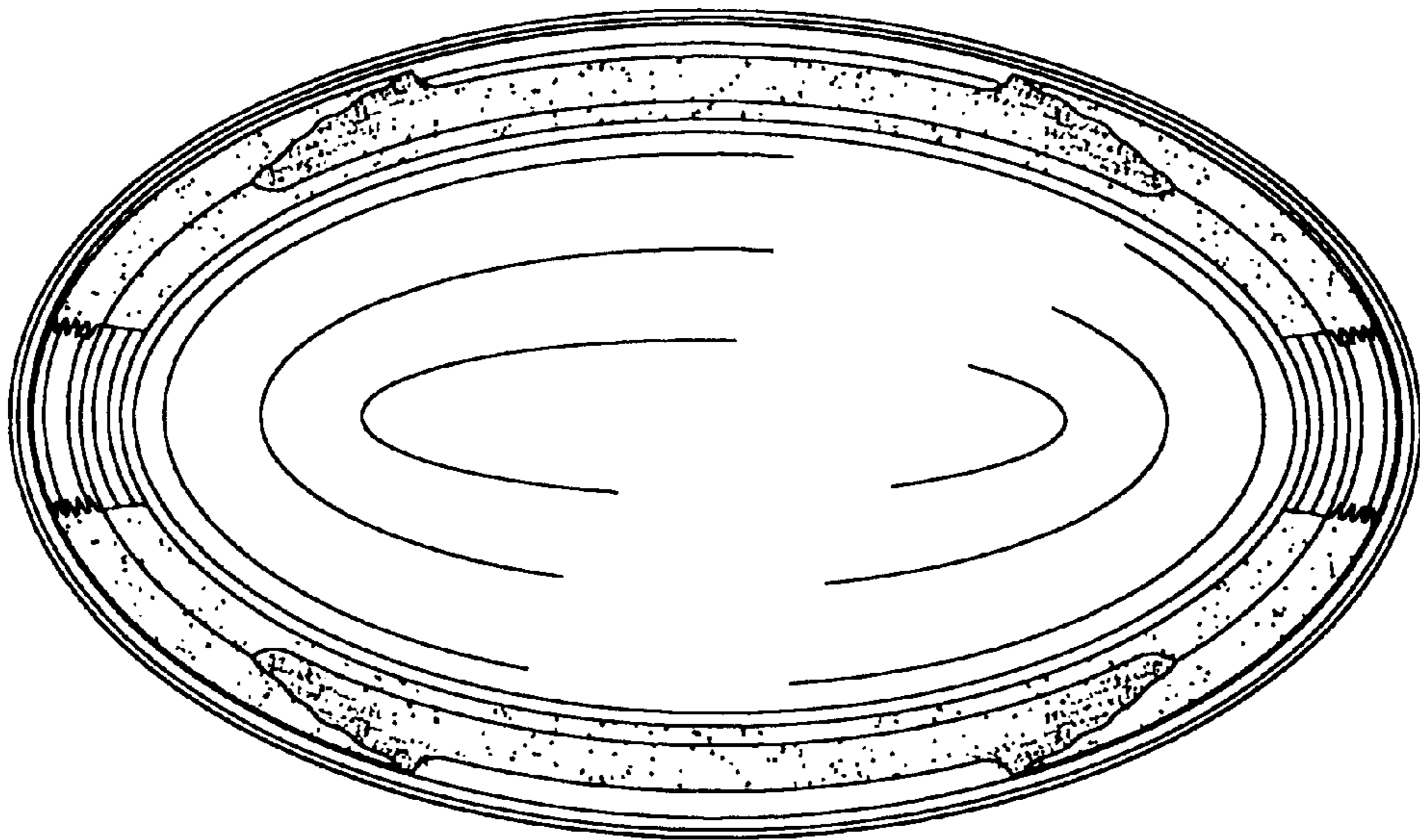

FIG. 37

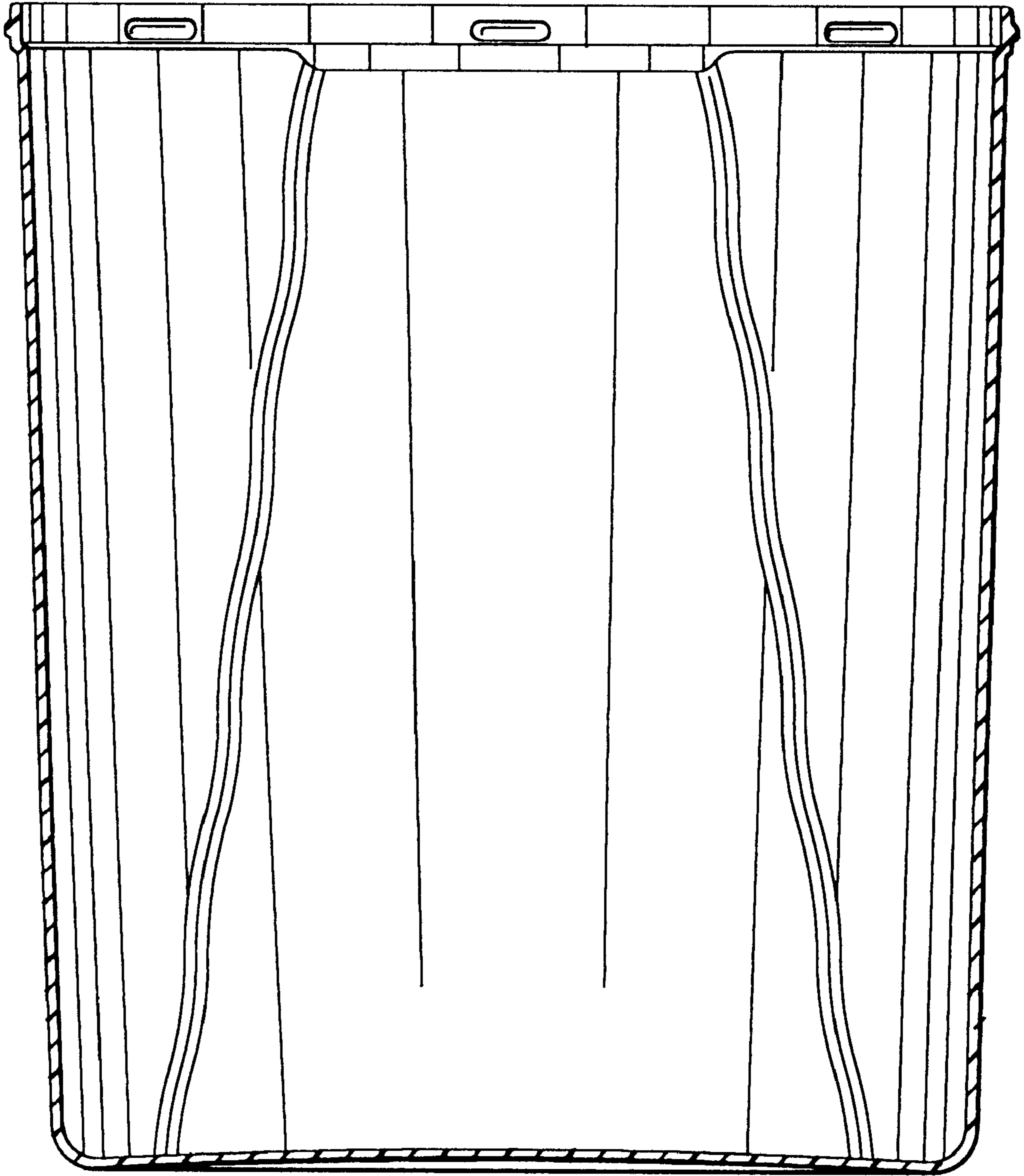

FIG. 38

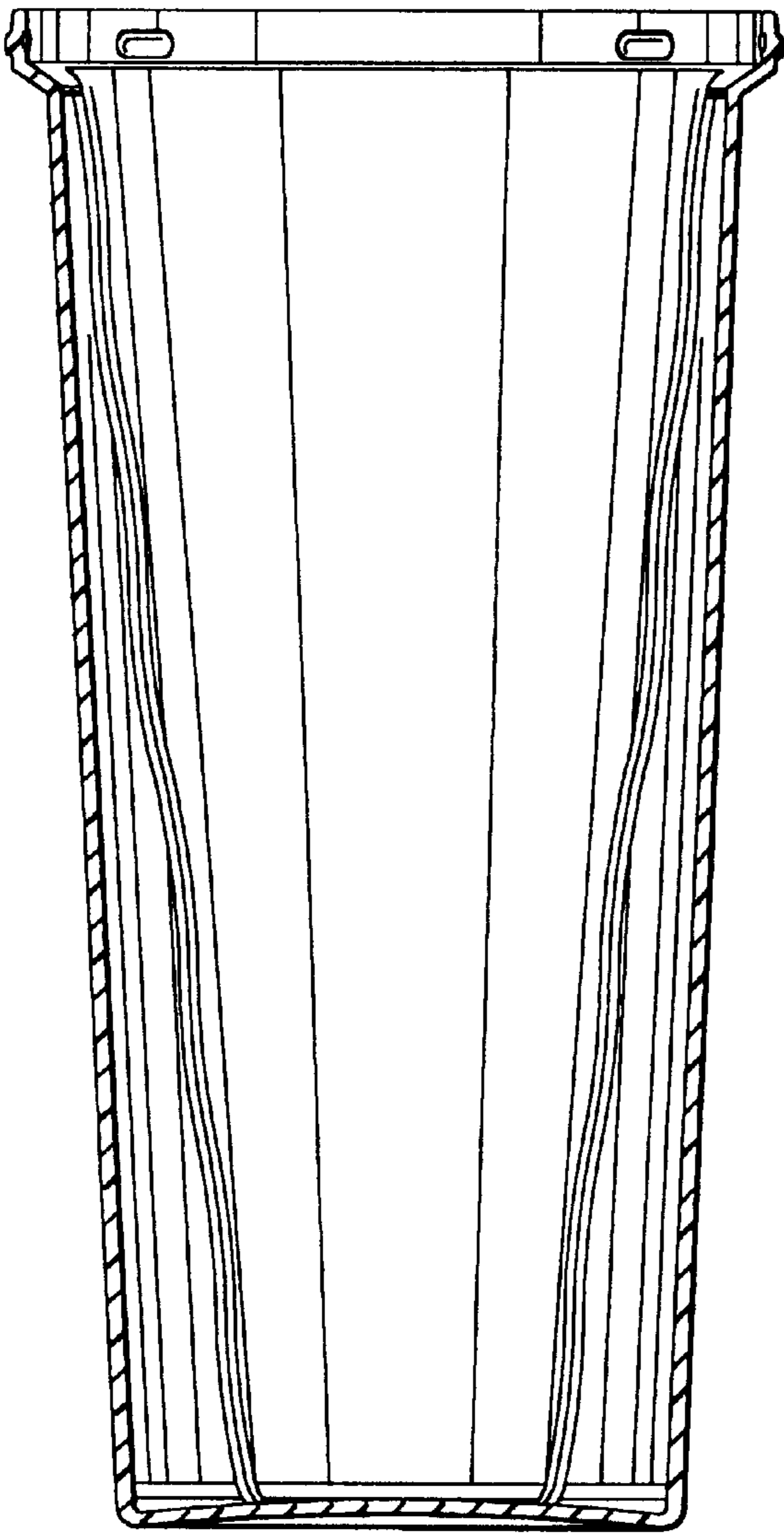

FIG. 39

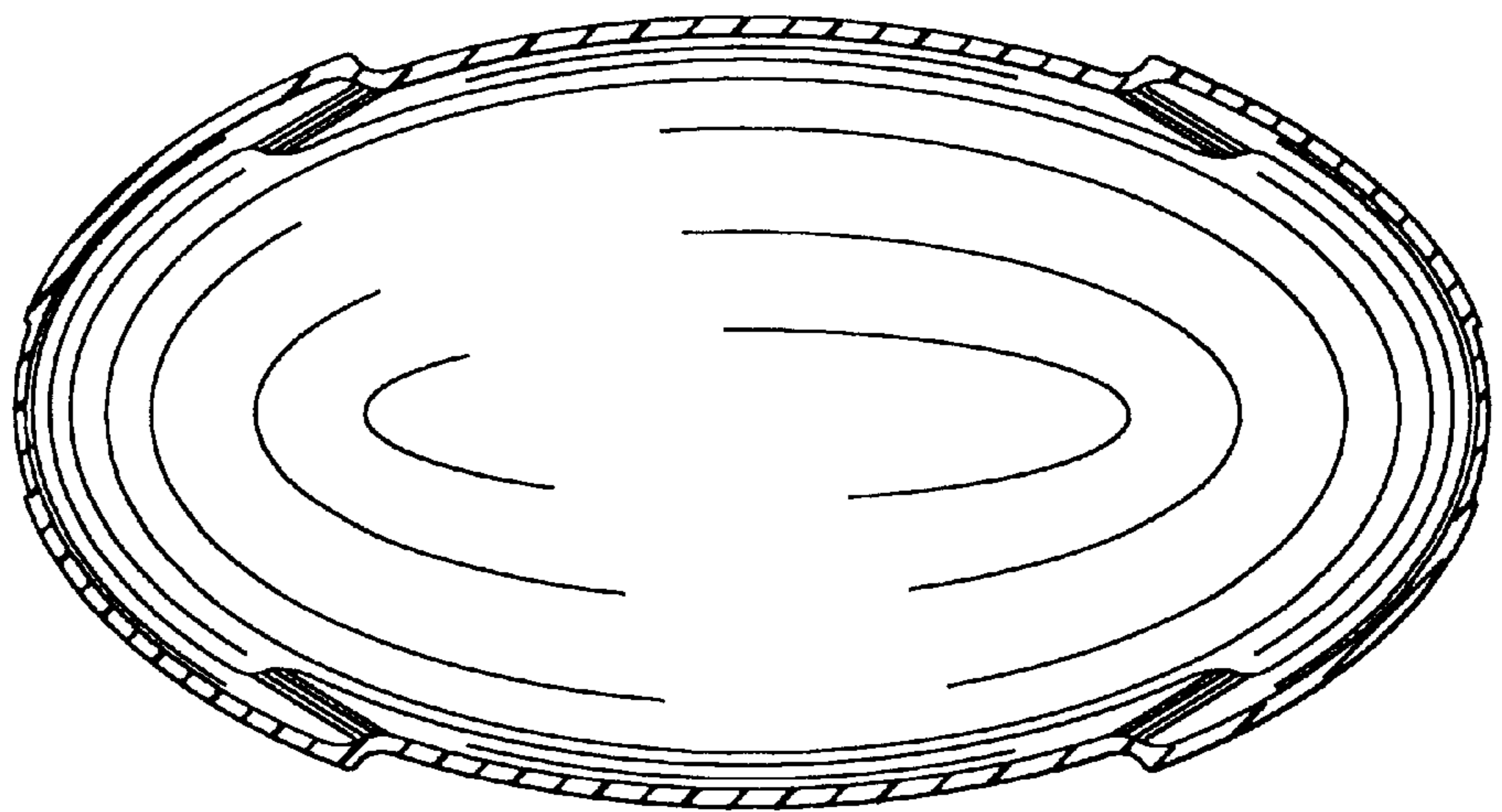

FIG. 40