



US00D418648S

United States Patent [19] Gudefin

[11] **Patent Number: Des. 418,648**
[45] **Date of Patent: ** Jan. 4, 2000**

[54] **IRON WITH REMOVABLE WATER TANK**
[75] Inventor: **Jacques Gudefin**, Saint Priest, France
[73] Assignee: **Calor S.A.**, Lyons, France
[**] Term: **14 Years**

[21] Appl. No.: **29/090,390**
[22] Filed: **Jul. 8, 1998**

[30] Foreign Application Priority Data

Jan. 9, 1998 [FR] France 98 0083

[51] **LOC (7) Cl.** **07-05**
[52] **U.S. Cl.** **D32/70**
[58] **Field of Search** D32/70, 68, 69,
D32/71; 38/77.1-77.5, 74, 69, 79, 72.8,
77.7, 77.9, 141, 142; 219/245, 249

[56] References Cited

U.S. PATENT DOCUMENTS

D. 313,683	1/1991	Chen	D32/68
D. 315,238	3/1991	Tien-Lai	D32/70
D. 315,433	3/1991	Chen	D32/68
D. 369,004	4/1996	Reibl	D32/70
D. 370,103	5/1996	Gudefin	D32/70
D. 370,104	5/1996	Gudefin	D32/70
D. 374,322	10/1996	Maeda et al.	D32/70
D. 374,527	10/1996	Gudefin	D32/68
D. 374,956	10/1996	Hsu	D32/70
D. 376,233	12/1996	Clouet	D32/70
D. 379,702	6/1997	Gudefin	D32/73
D. 386,863	11/1997	Lin	D32/70
D. 388,576	12/1997	Gudefin	D32/73
D. 389,622	1/1998	Dziersk	D32/70
D. 389,969	1/1998	Dziersk	D32/70
D. 393,509	4/1998	Gudefin	D32/70

Primary Examiner—Alan P. Douglas
Assistant Examiner—Cynthia E. Ramirez
Attorney, Agent, or Firm—Greenblum & Bernstein, P.L.C.

[57] CLAIM

I claim the ornamental design for an iron with removable water tank, as shown and described.

DESCRIPTION

FIG. 1 is a perspective view from the front and left of my new design;
 FIG. 2 is a front elevation view thereof;
 FIG. 3 is a rear elevation view thereof;
 FIG. 4 is a side elevation view from the left of FIG. 2;
 FIG. 5 is a side elevation view from the right of FIG. 2;
 FIG. 6 is a top view thereof;
 FIG. 7 is a bottom view thereof;
 FIG. 8 is a front elevation view thereof, showing two portions of the iron of the design in another position, a forward tank portion being removed from the remainder of the iron;
 FIG. 9 is a top view of the removed tank portion;
 FIG. 10 is a bottom view of the removed tank portion;
 FIG. 11 is a rear elevation view of the removed tank portion;
 FIG. 12 is a front elevation view of the iron, with the tank portion removed; and,
 FIG. 13 is a top view of the iron, with the tank portion removed.

Each of the two laterally opposed buttons shown at the top of the iron can assume, independently, either of upper and lower positions shown in FIGS. 1 and 4.

The body of the iron has been omitted from FIGS. 9 through 11 for convenience of illustration. The water tank is not shown in FIGS. 12 and 13 for convenience of illustration.

1 Claim, 13 Drawing Sheets

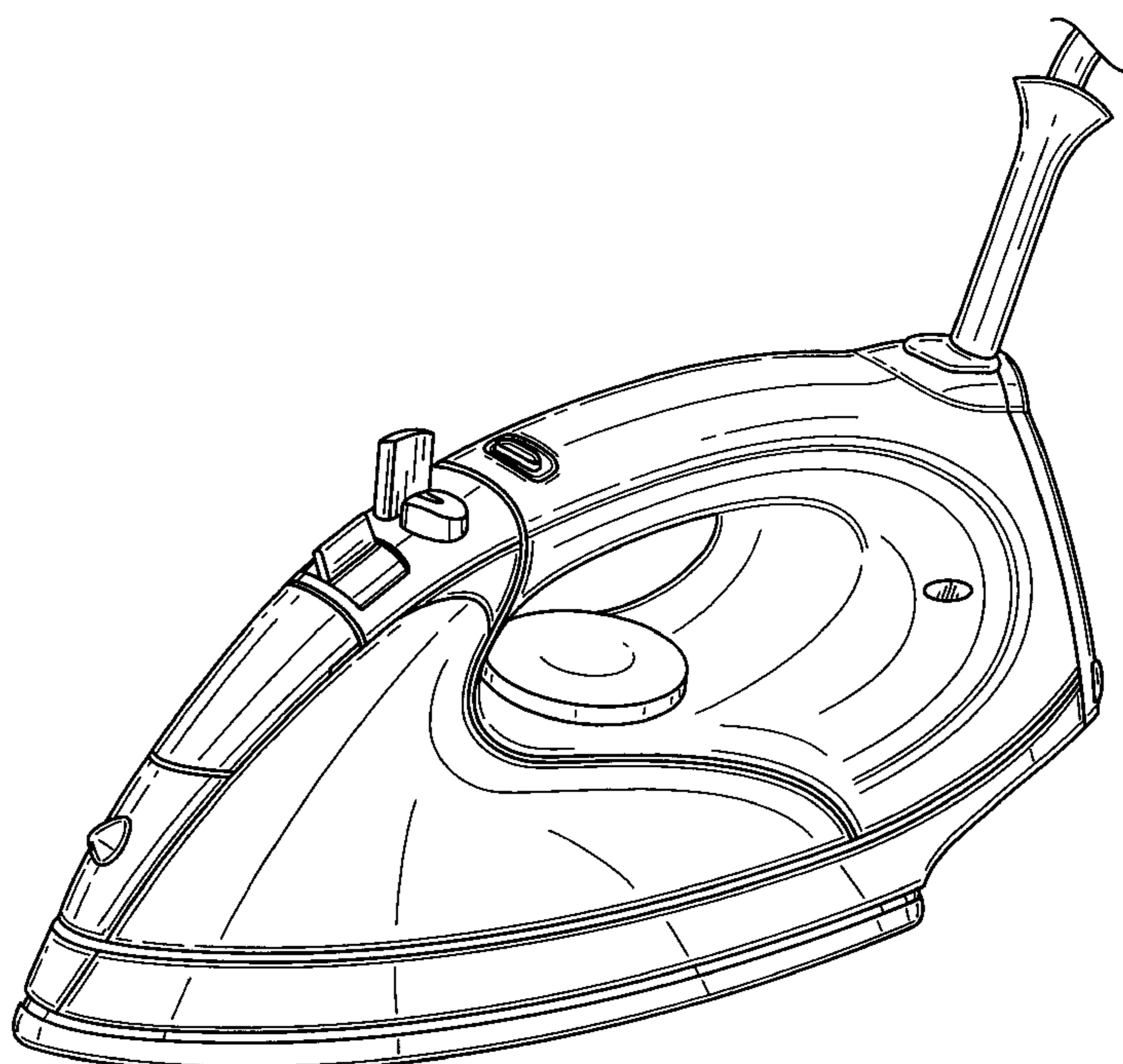

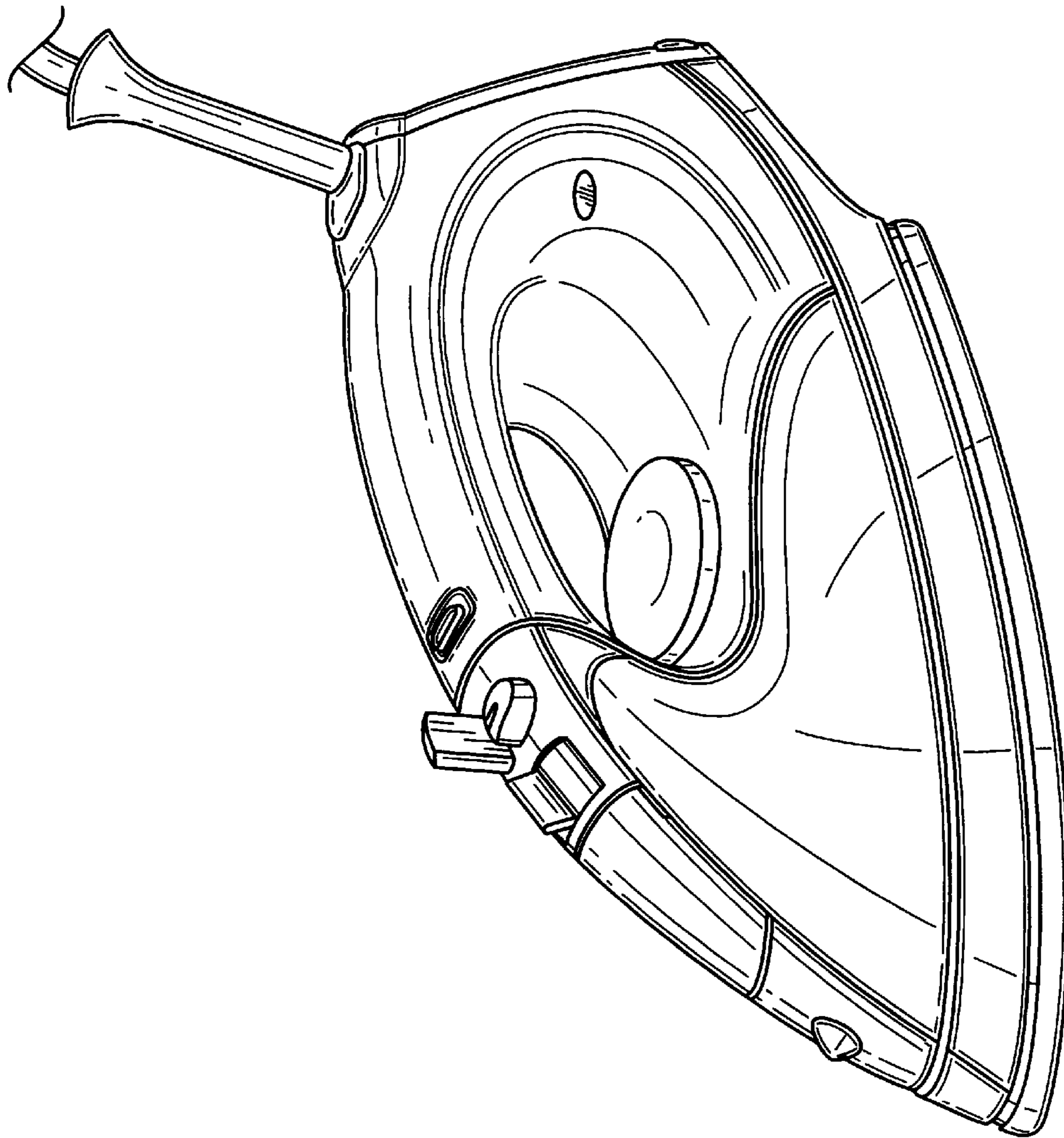

FIG. 1

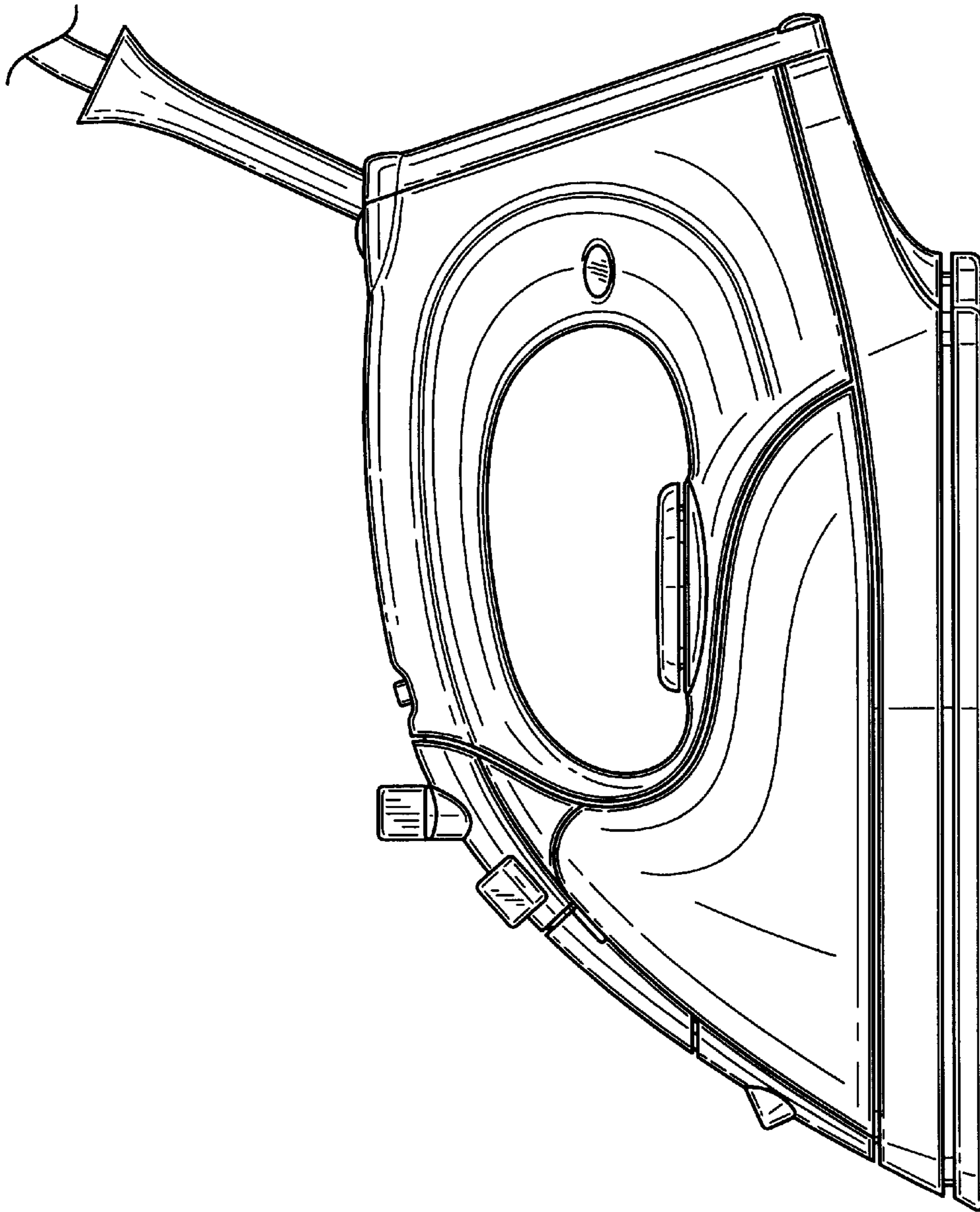

FIG. 2

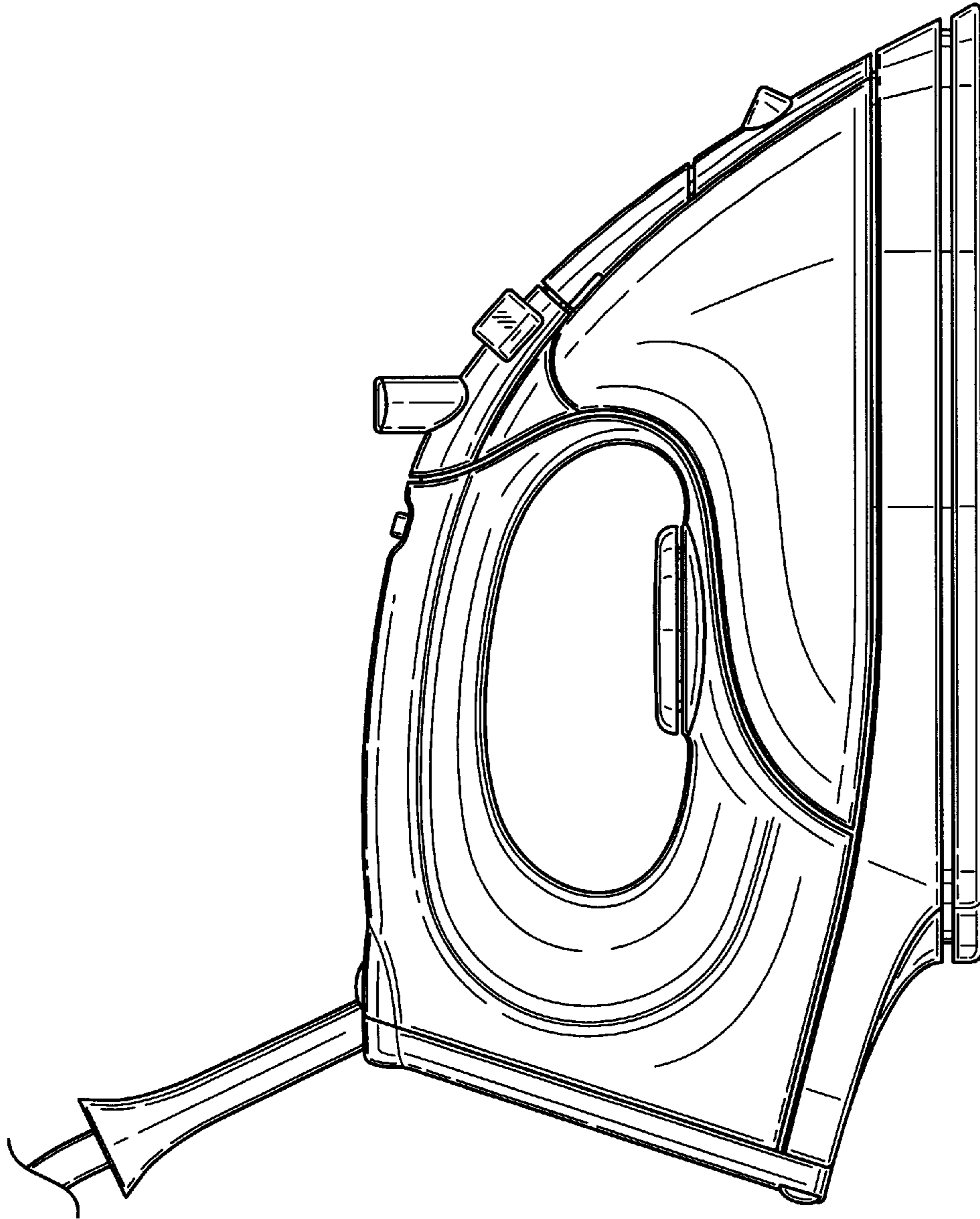

FIG. 3

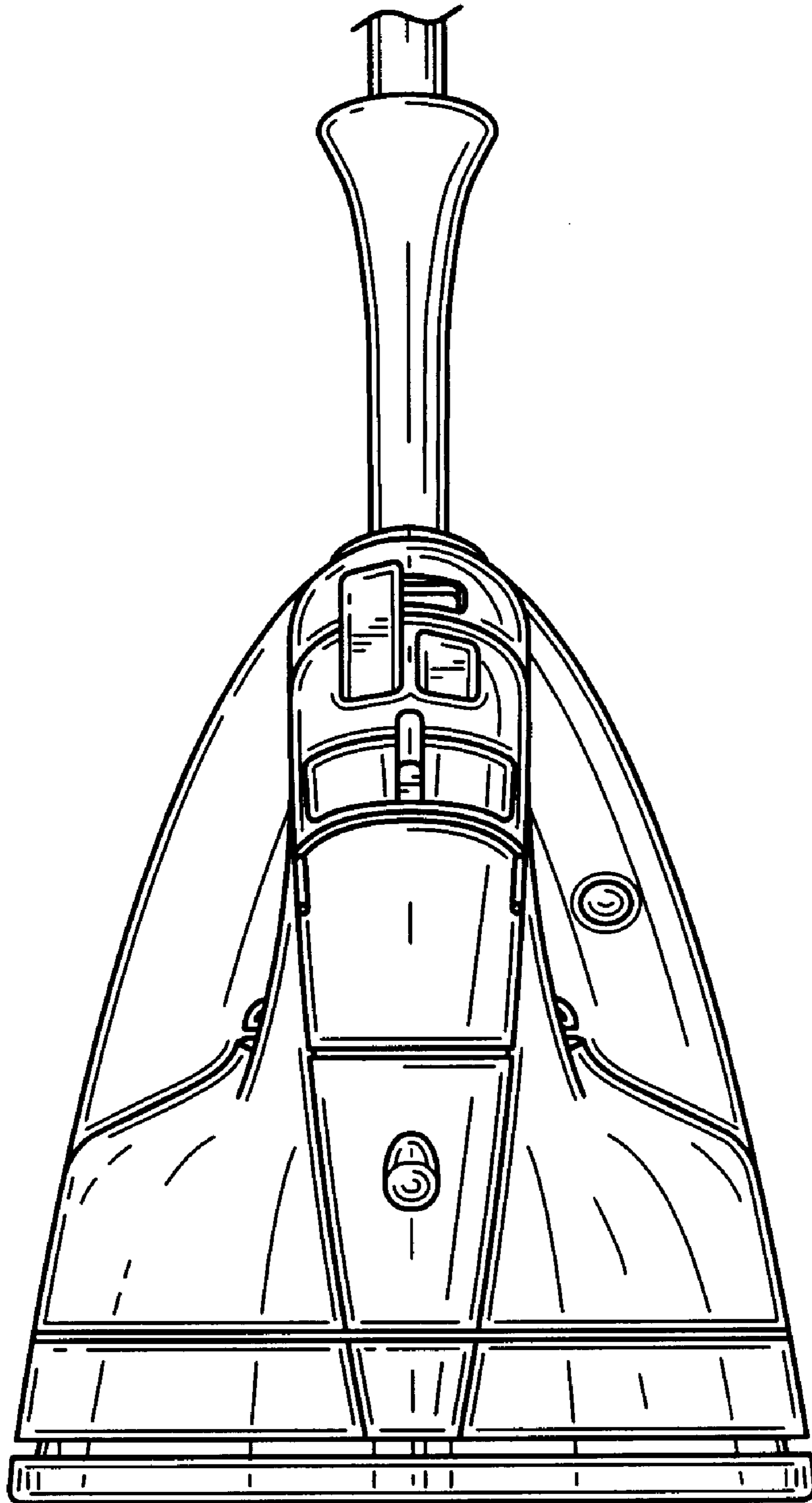

FIG. 4

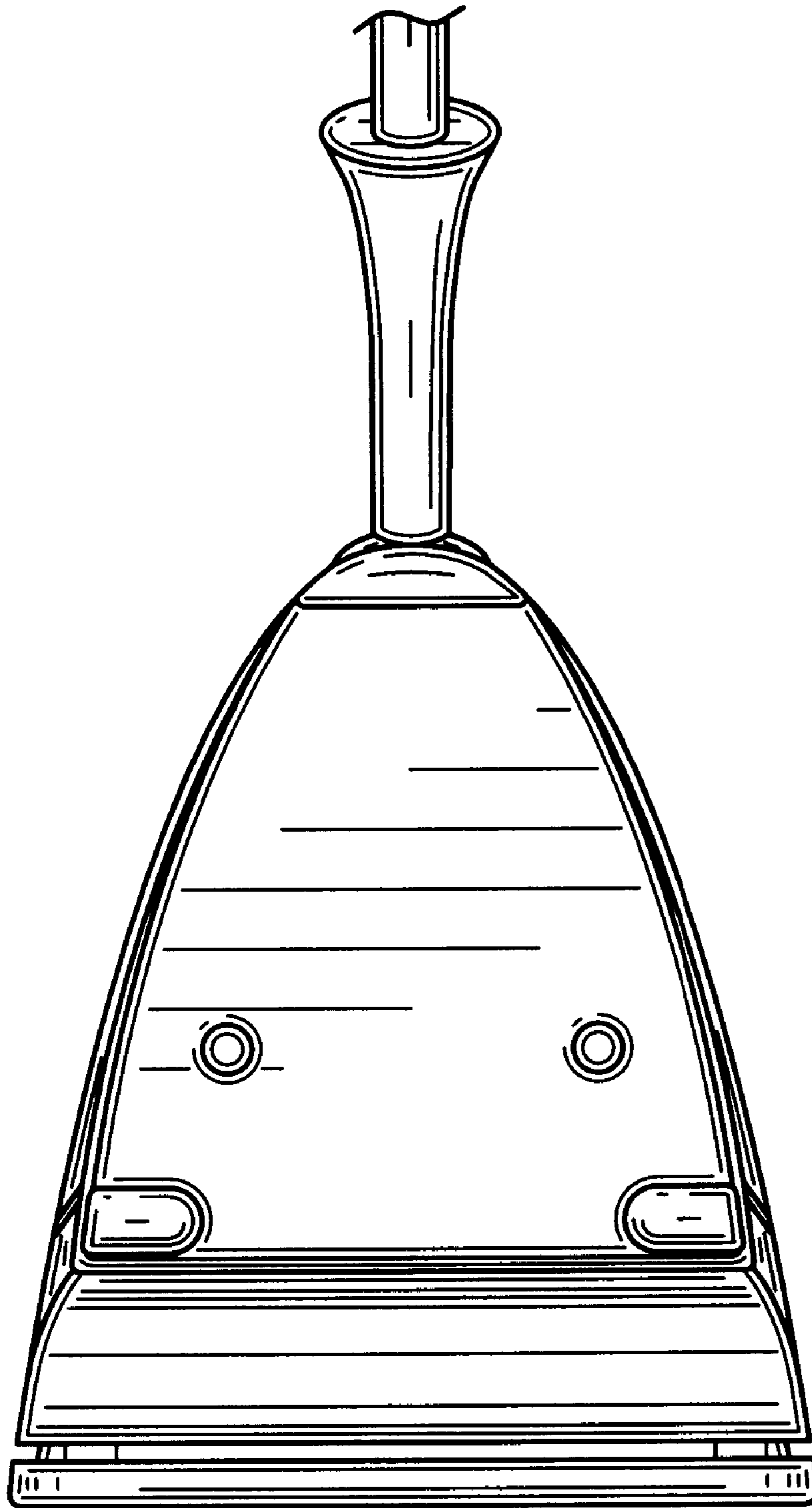

FIG. 5

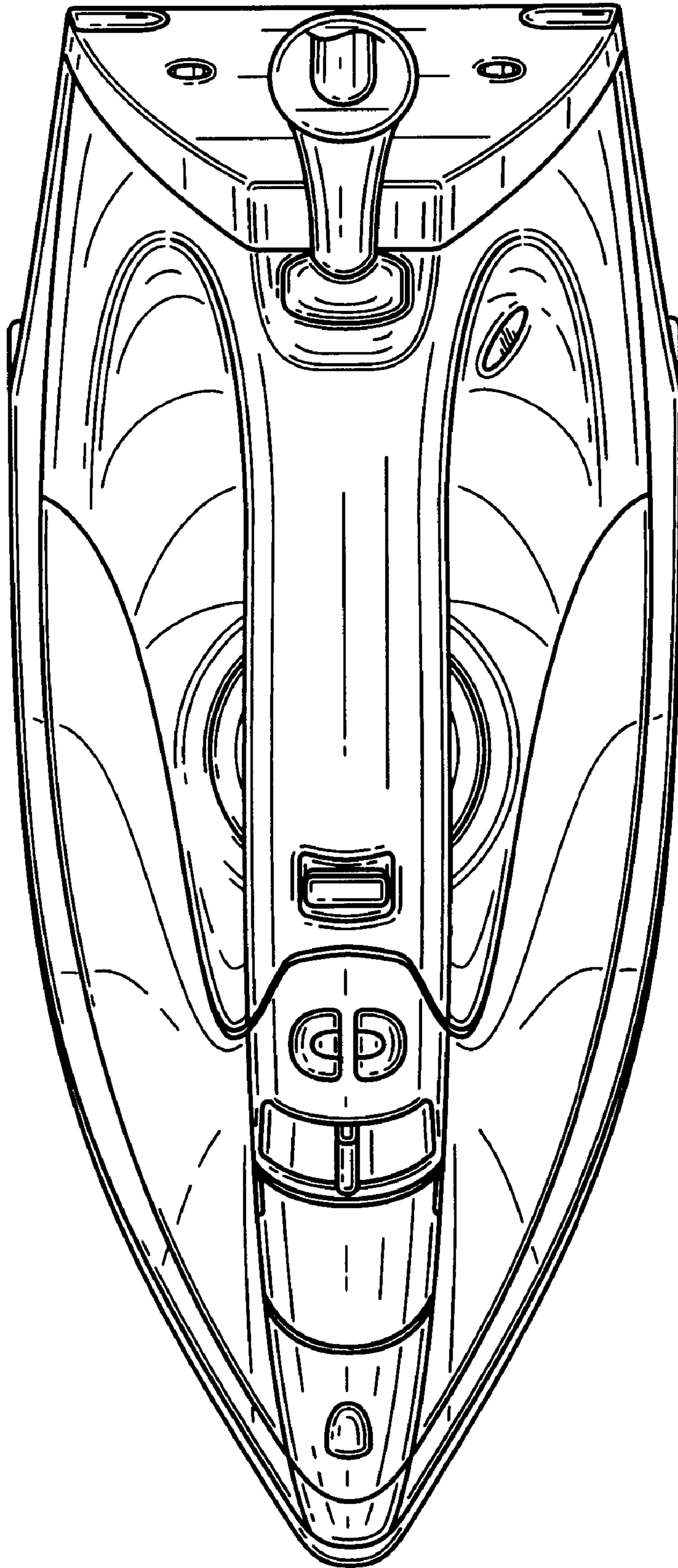

FIG. 6

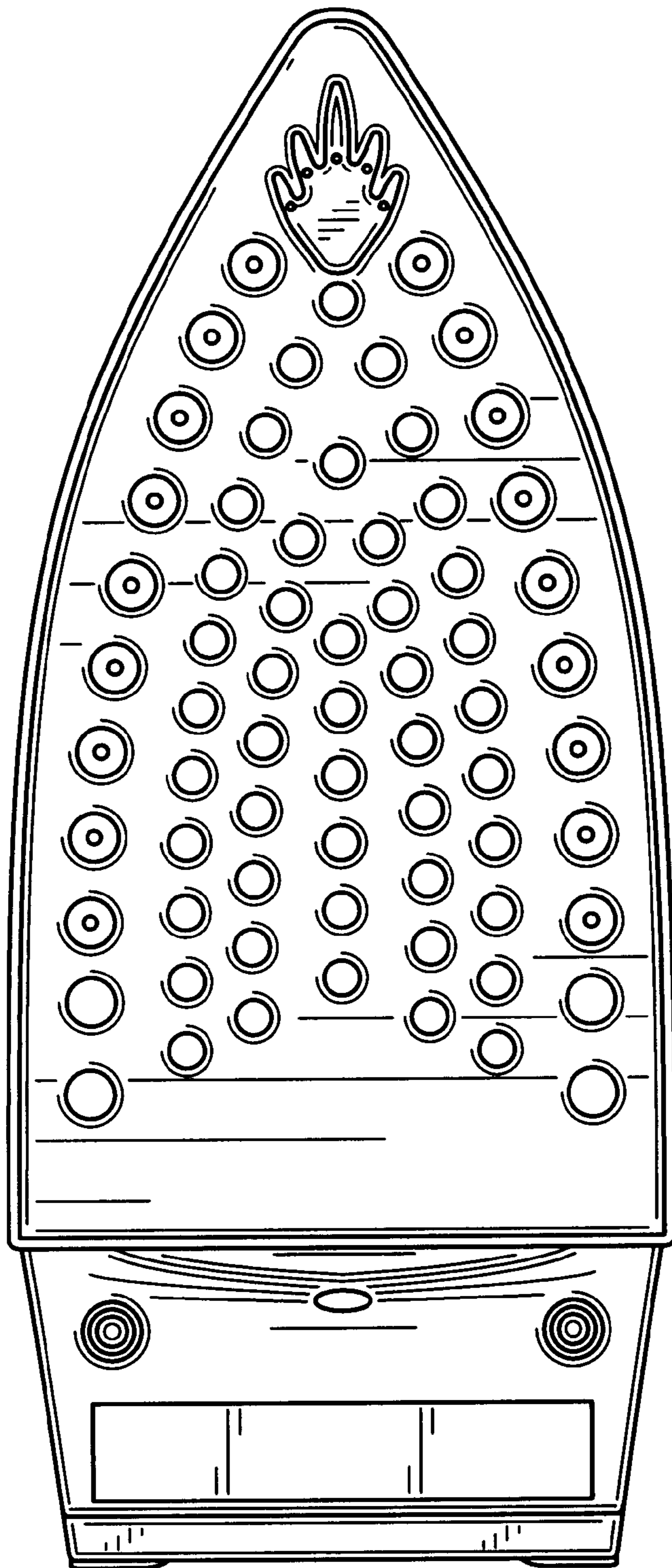

FIG. 7

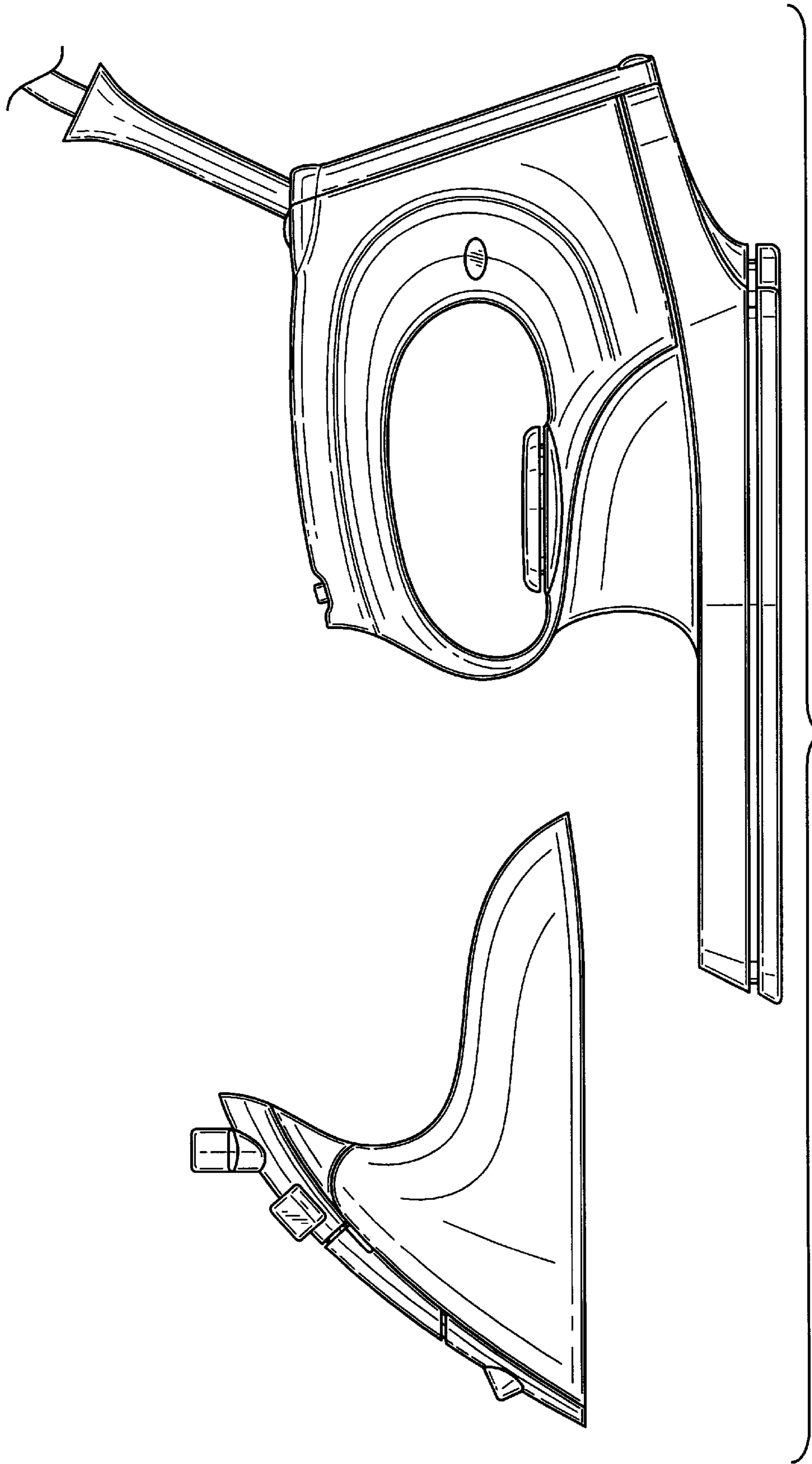

FIG. 8

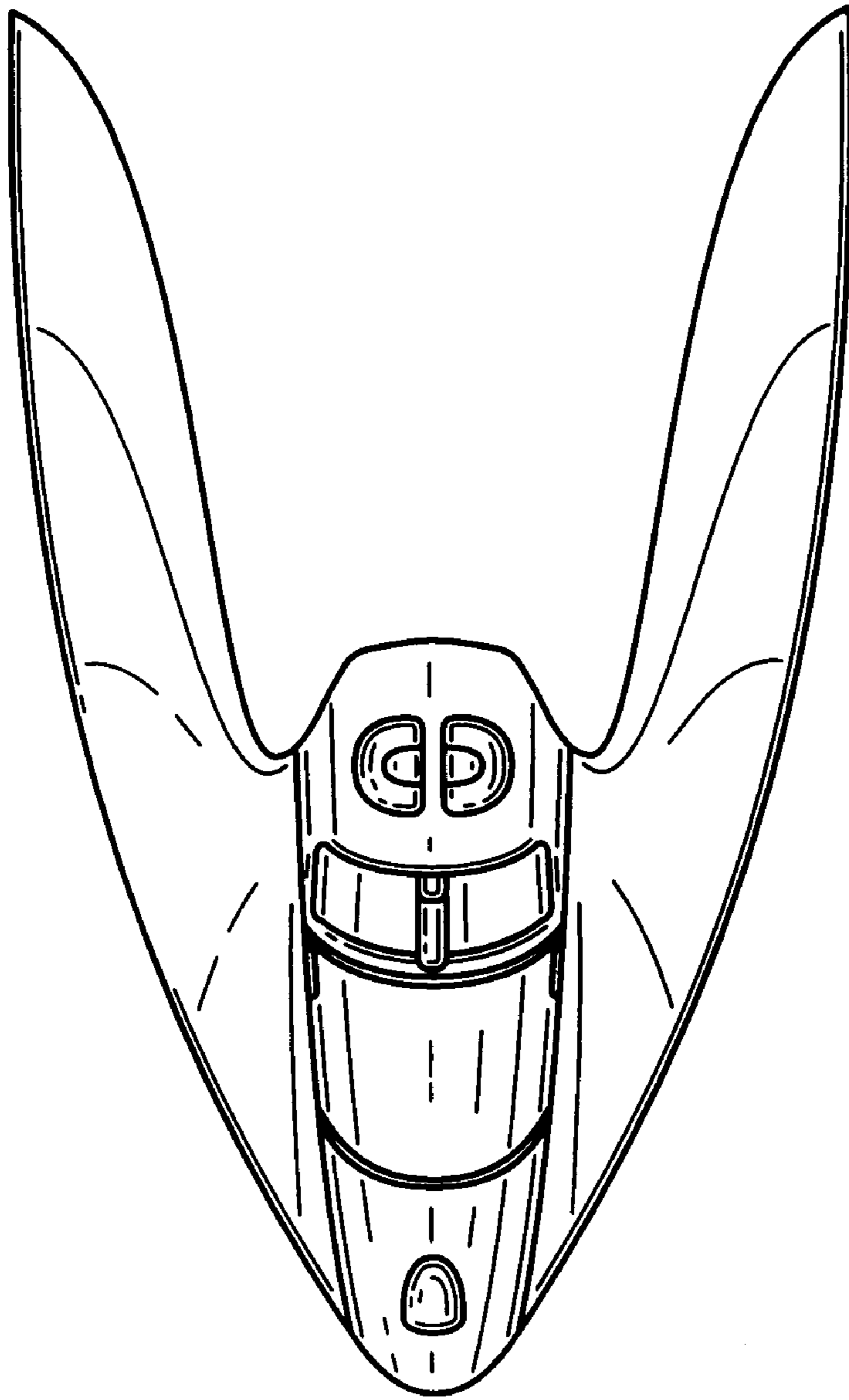

FIG. 9

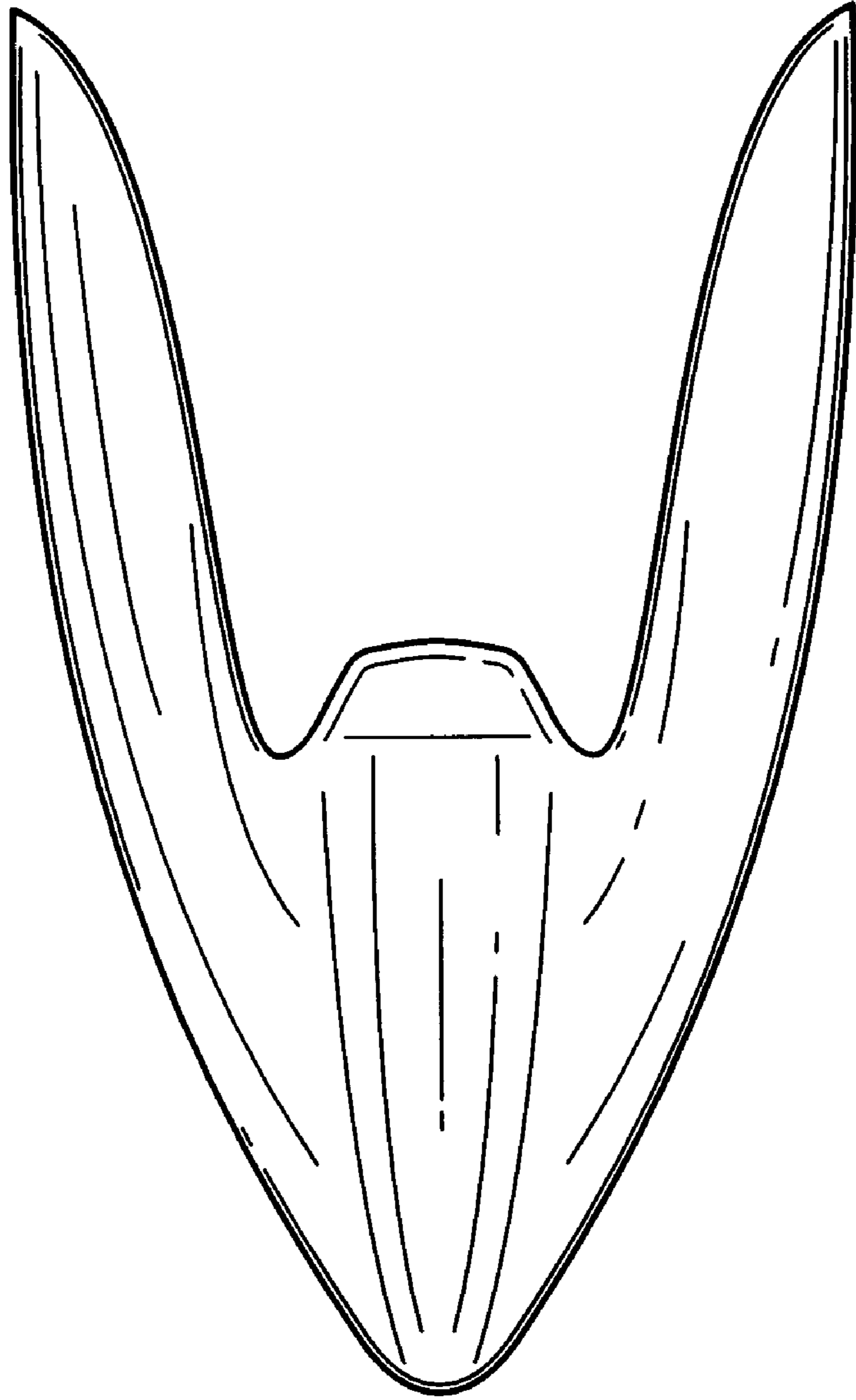

FIG. 10

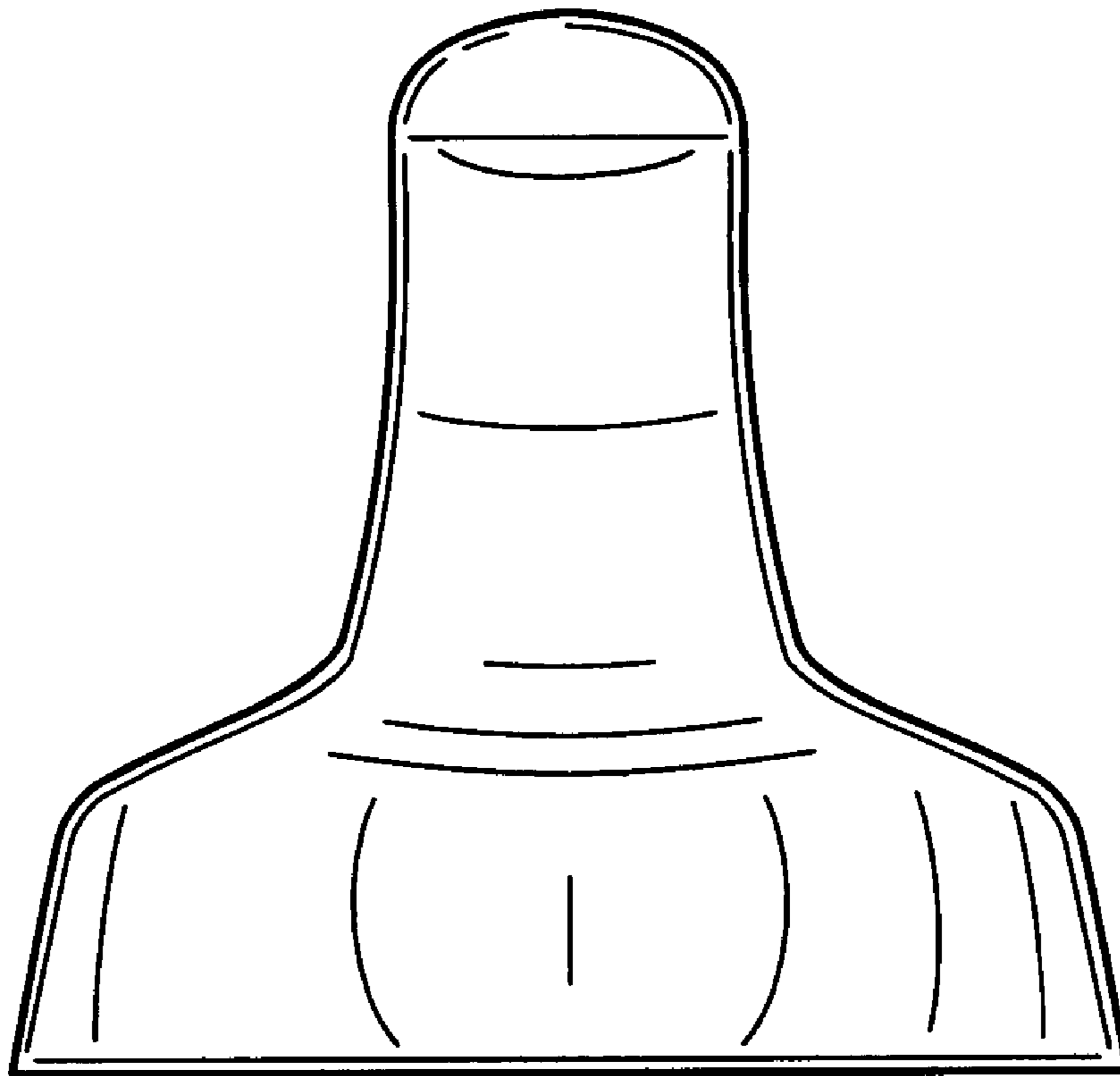

FIG. 11

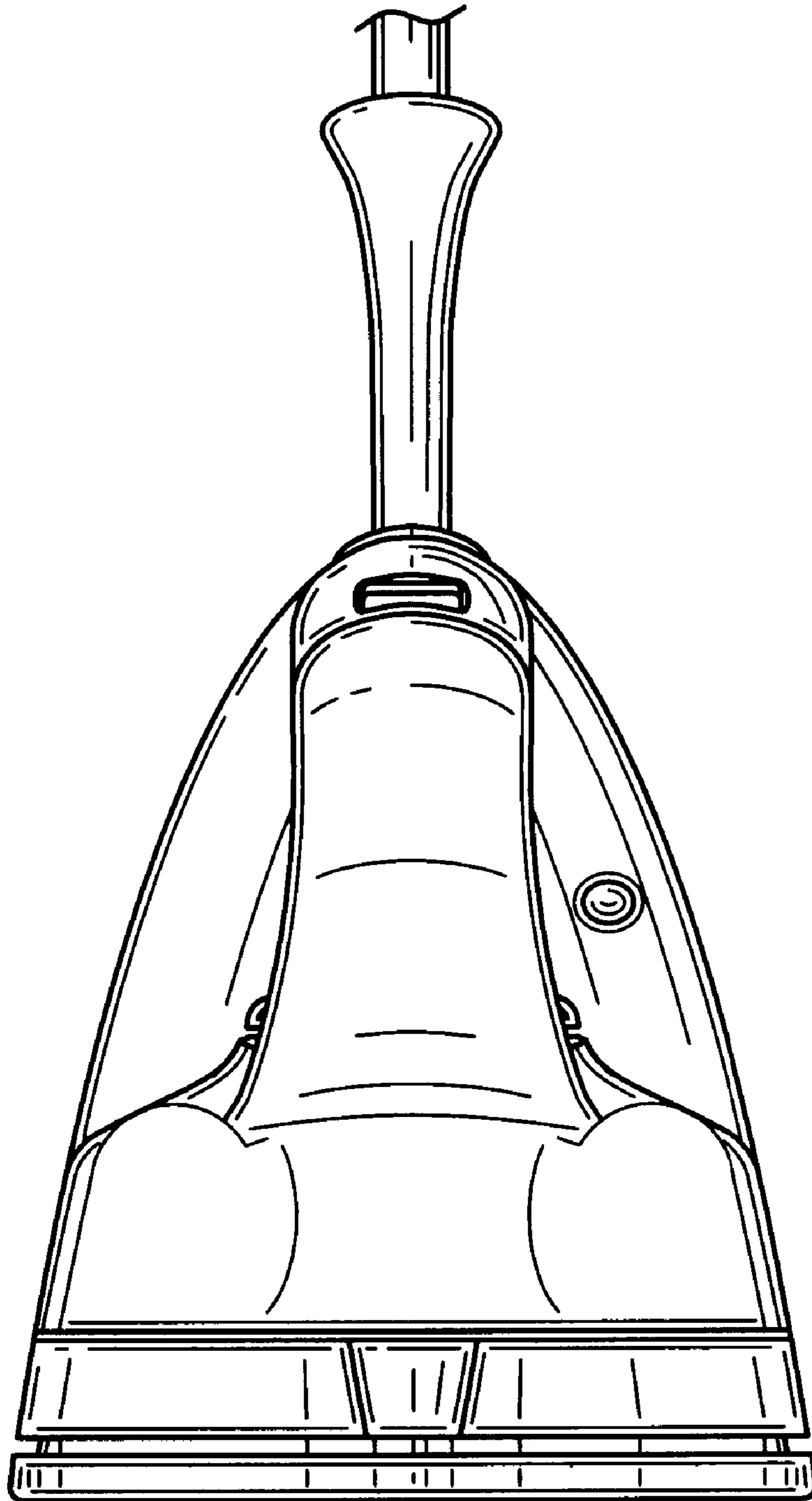

FIG. 12

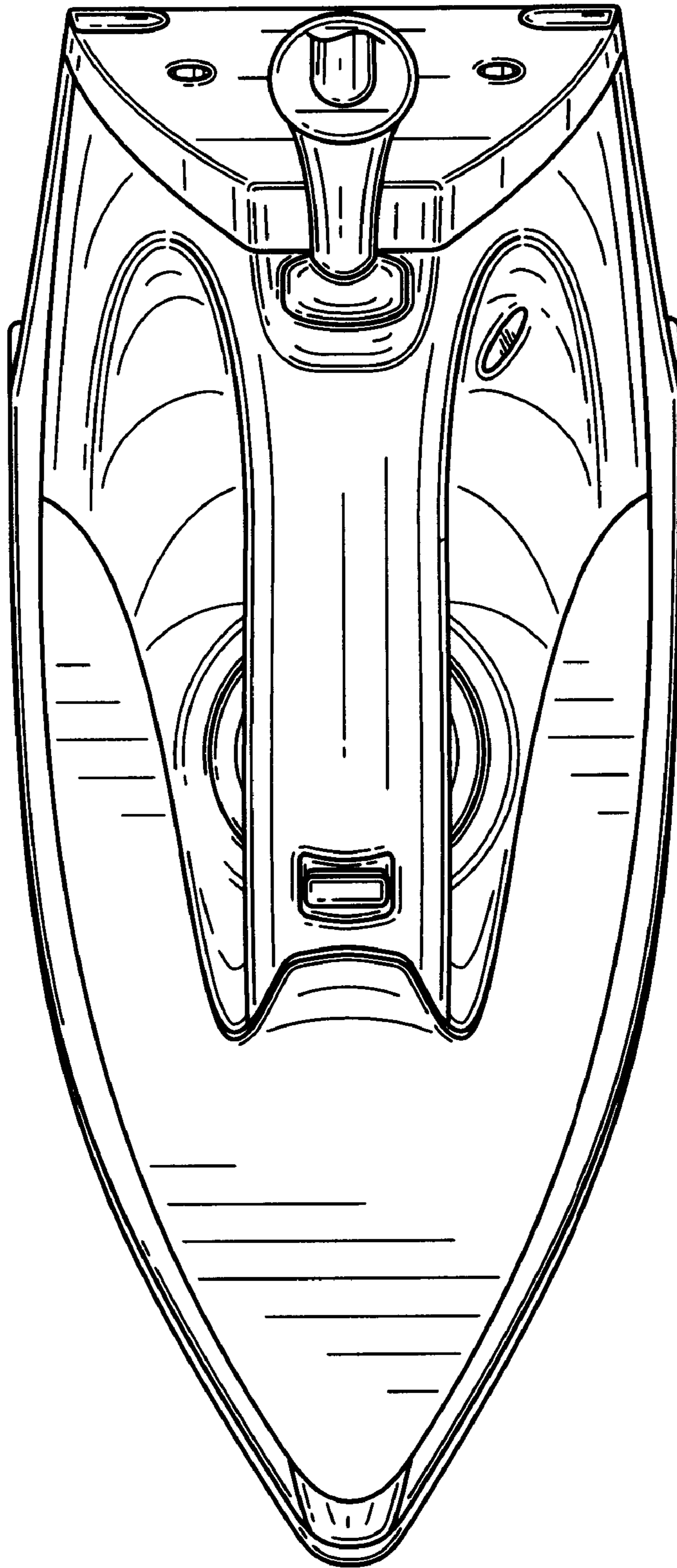

FIG. 13