



US00D418488S

United States Patent [19]

NG et al.

[11] Patent Number: **Des. 418,488**

[45] Date of Patent: **** Jan. 4, 2000**

[54] **COMPUTER USER INTERFACE**

[75] Inventors: **Weng Hong NG; Yeow Choon Lim,**
both of Singapore, Singapore

[73] Assignee: **Creative Technology Ltd.,** Singapore,
Singapore

[**] Term: **14 Years**

[21] Appl. No.: **29/090,870**

[22] Filed: **Jul. 17, 1998**

[51] **LOC (7) Cl.** **14-02**

[52] **U.S. Cl.** **D14/101; D14/151**

[58] **Field of Search** D14/100, 101,
D14/106, 113, 115, 130, 144, 151; 361/680-686;
379/434-436

[56] **References Cited**

U.S. PATENT DOCUMENTS

D. 300,740	4/1989	Sekiguchi et al.	D14/151
D. 305,537	1/1990	Gilmore et al.	D14/101
D. 306,444	3/1990	Fried et al.	D14/151
D. 368,091	3/1996	Yoshihiko et al.	D14/151
D. 387,056	12/1997	Yoneyama	D14/151

Primary Examiner—Freda Nunn

Attorney, Agent, or Firm—Lawrence Y. D. Ho; David D. Chung; Jacqueline C. T. Lui

[57] **CLAIM**

The ornamental design for a computer user interface, as shown and described.

DESCRIPTION

FIG. 1 is a top perspective view of a computer user interface showing my new design;
 FIG. 2 is a bottom perspective view thereof;
 FIG. 3 is a top view thereof;
 FIG. 4 is a rear elevational view thereof;
 FIG. 5 is a front elevational view thereof;
 FIG. 6 is a bottom plan view thereof;
 FIG. 7 is a right side elevational view thereof;
 FIG. 8 is a left side elevational view thereof;
 FIG. 9 is a left side elevational view of the handset thereof shown separately for clarity of illustration only;
 FIG. 10 is a top plan view of the handset thereof;
 FIG. 11 is a right side elevational view of the handset thereof;
 FIG. 12 is a bottom plan view of the handset thereof;
 FIG. 13 is a rear elevational view of the handset thereof; and,
 FIG. 14 is a front elevational view of the handset thereof.
 FIGS. 3-8 are shown a reduced scale.

1 Claim, 5 Drawing Sheets

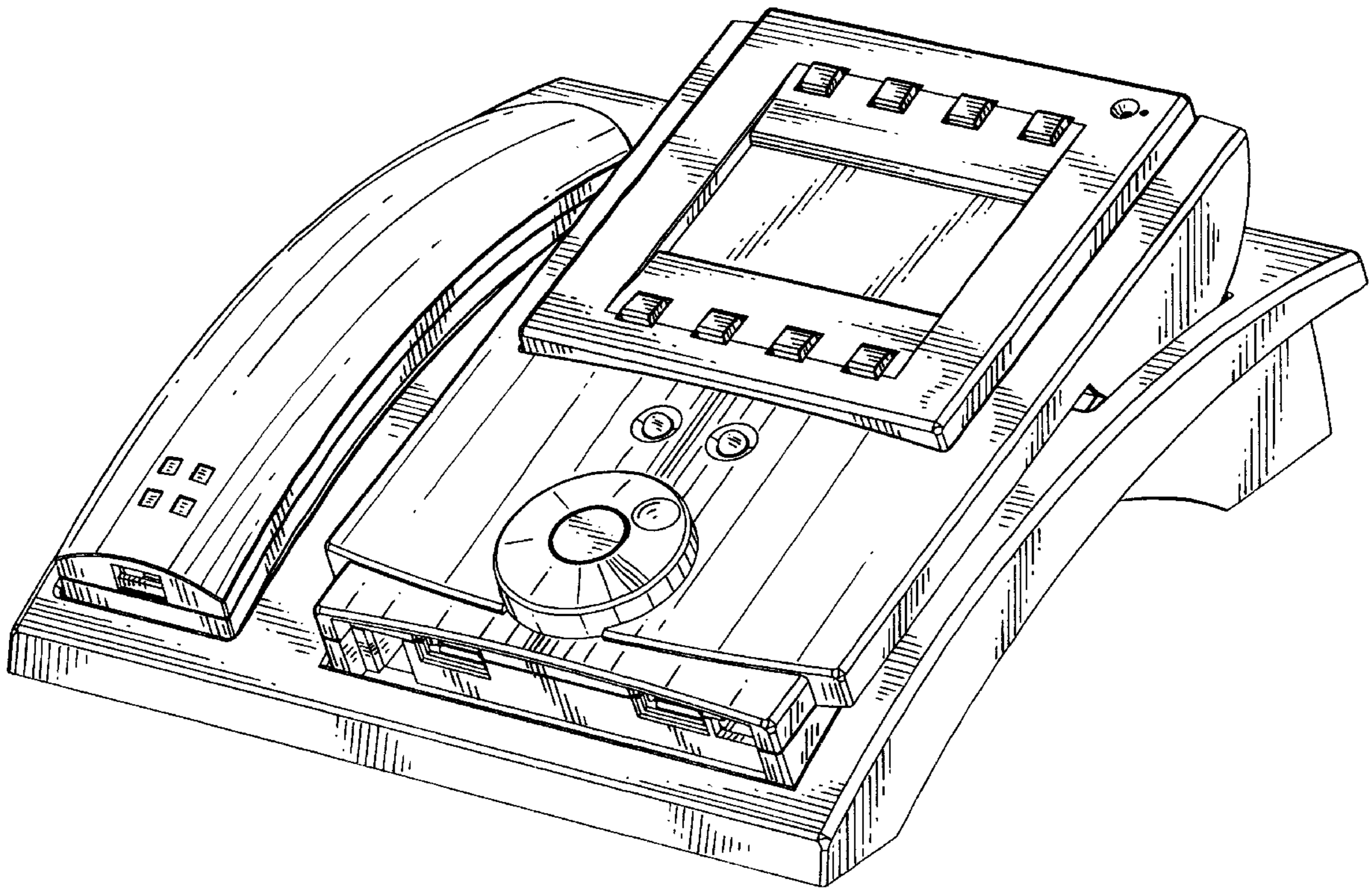

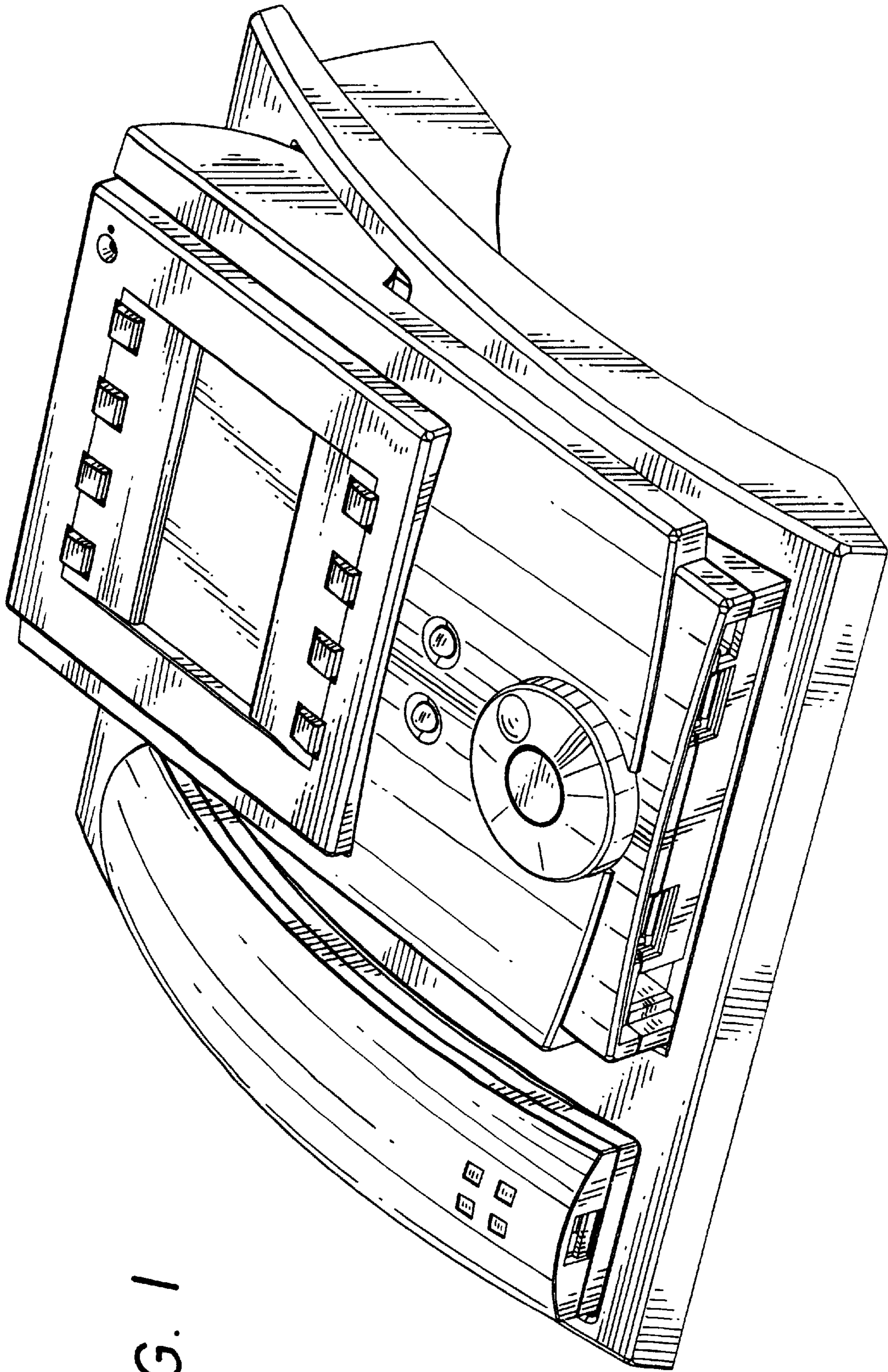

FIG. 1

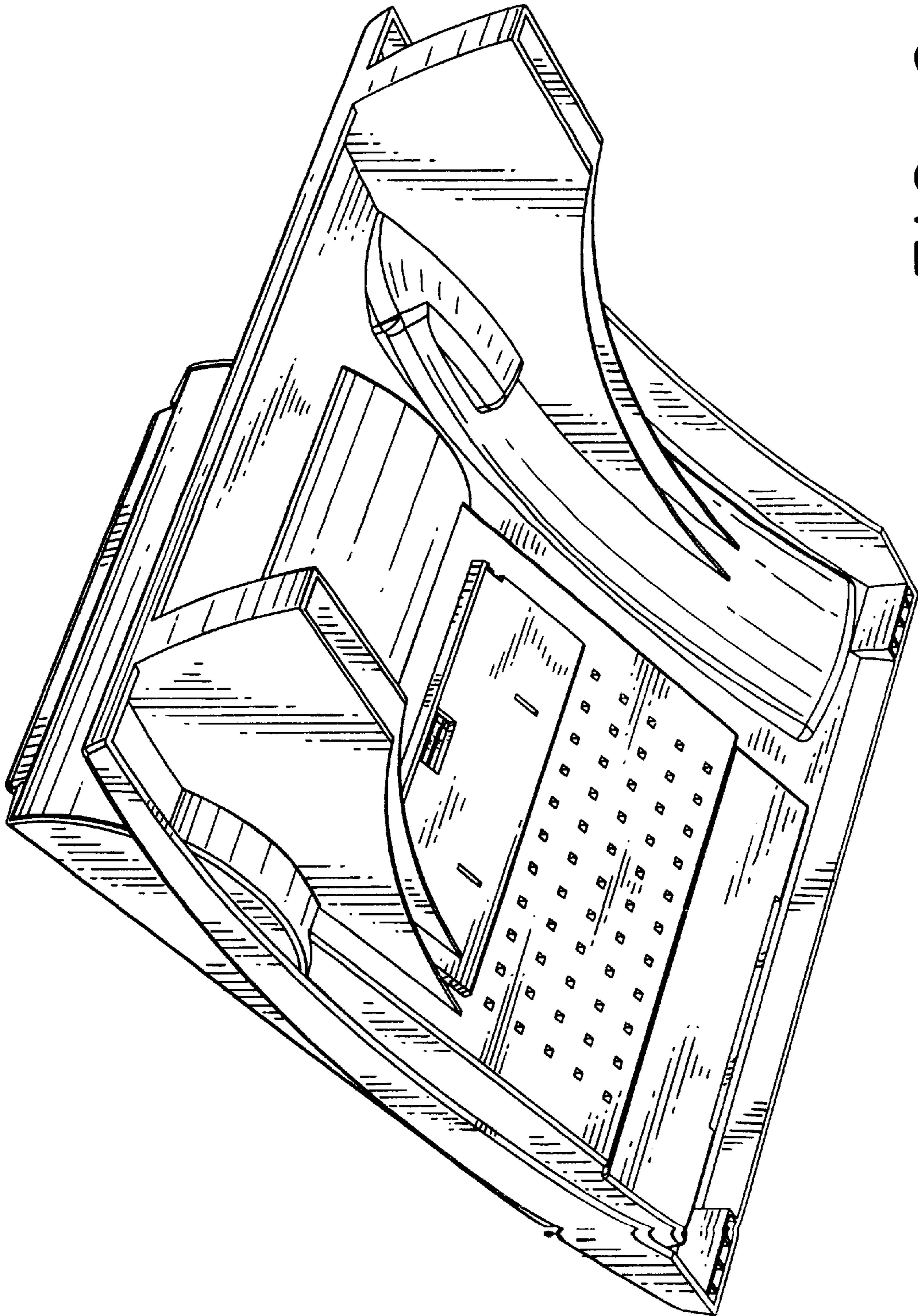

FIG. 2

FIG. 4

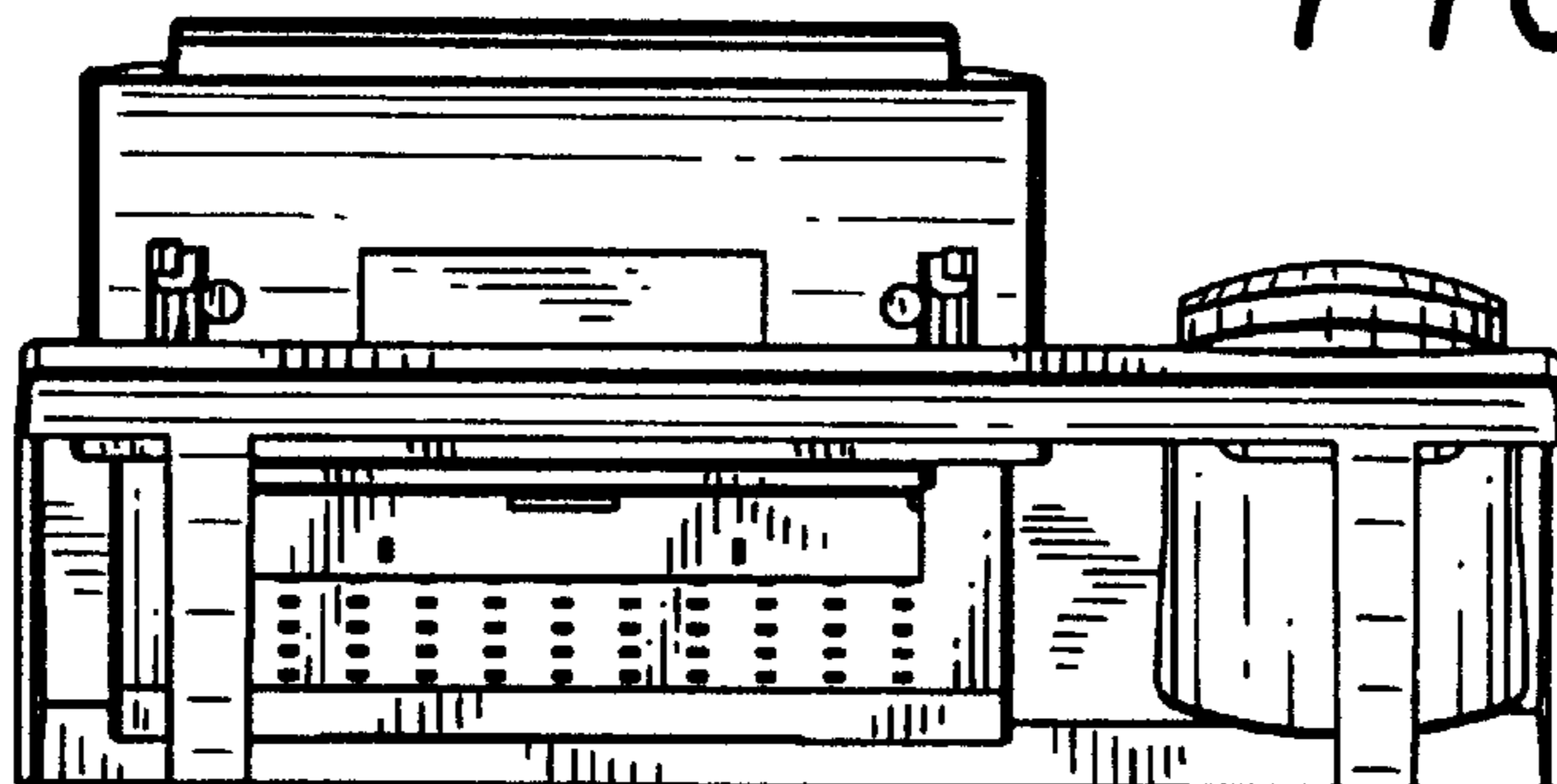

FIG. 3

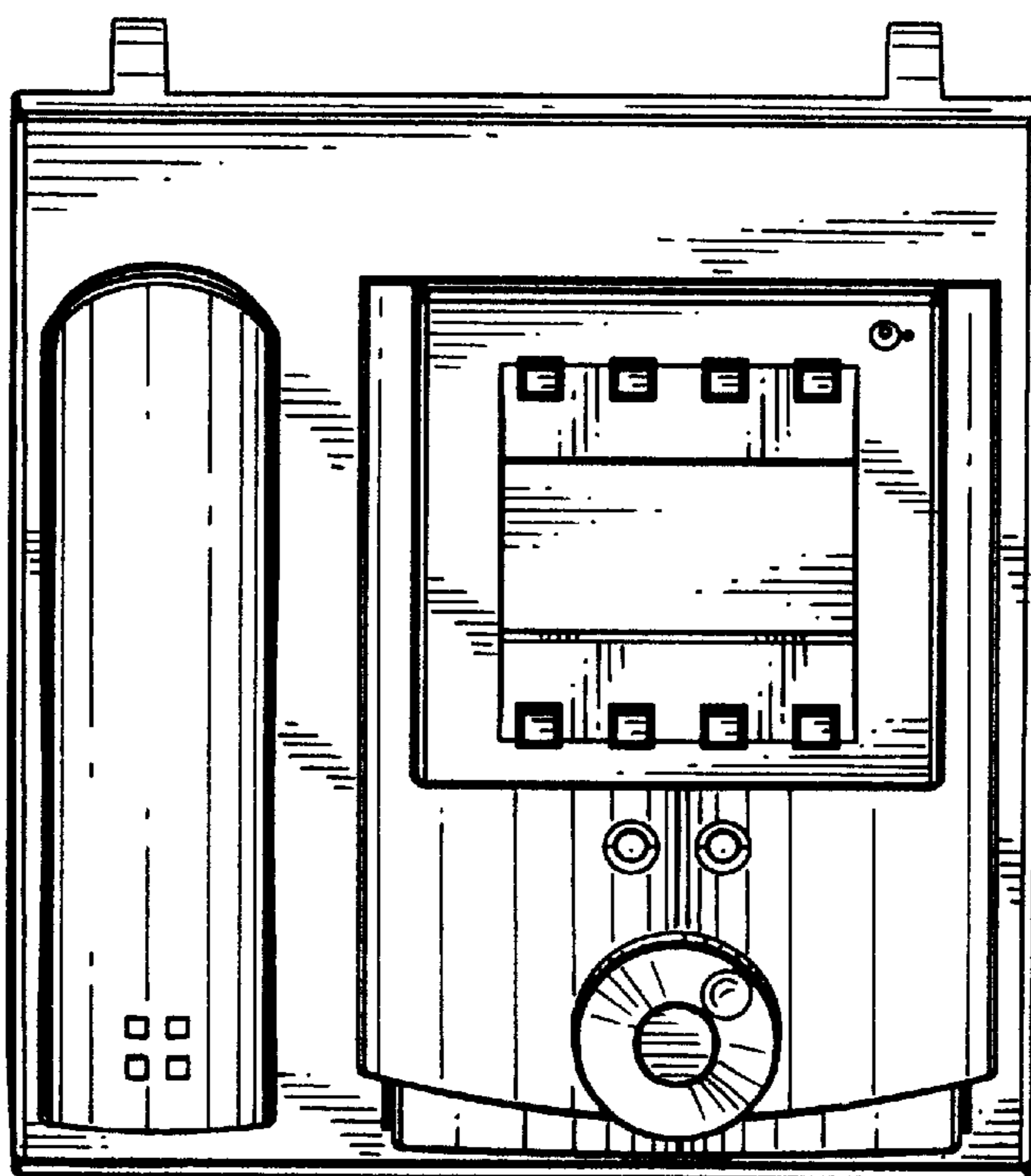
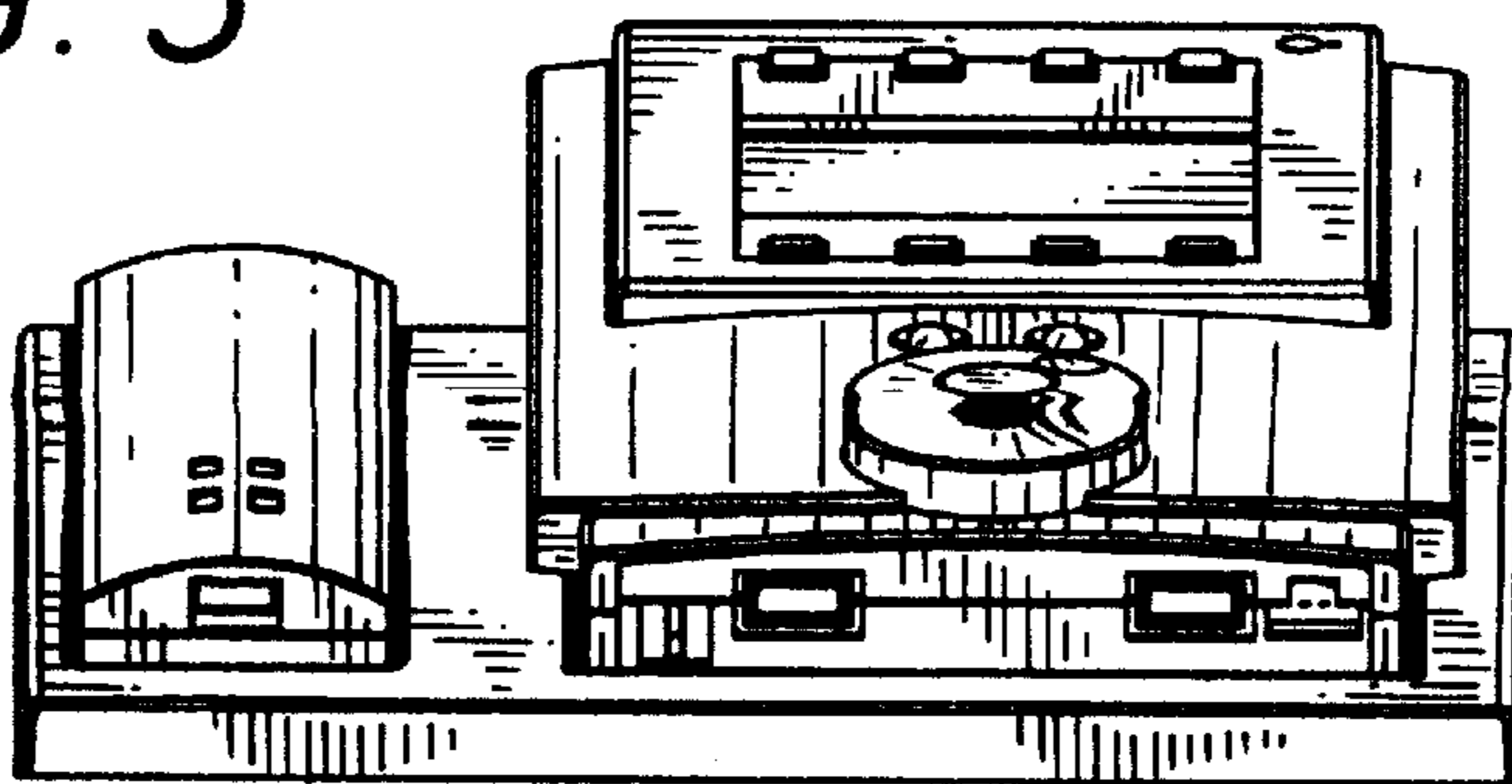

FIG. 5



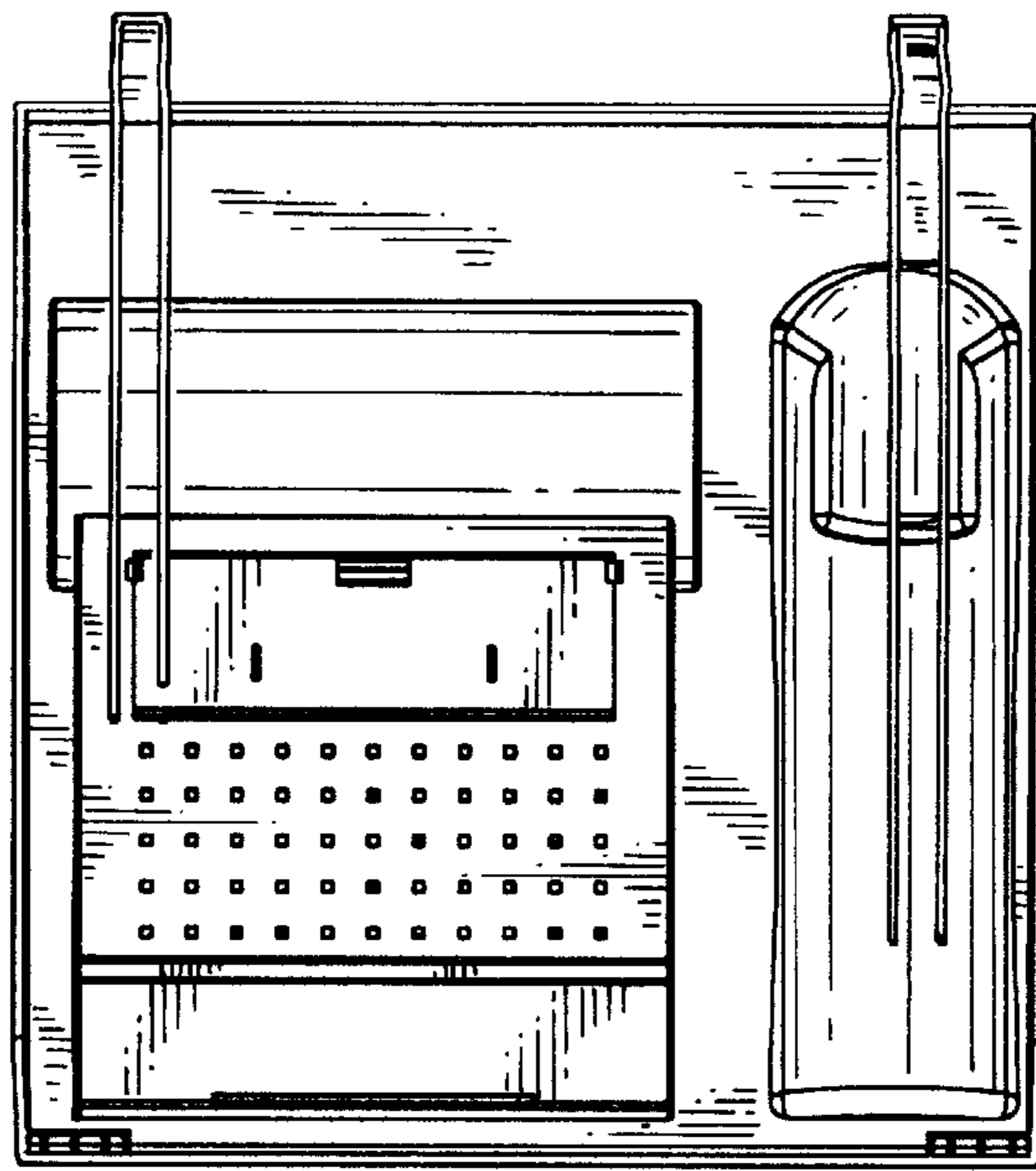

FIG. 6

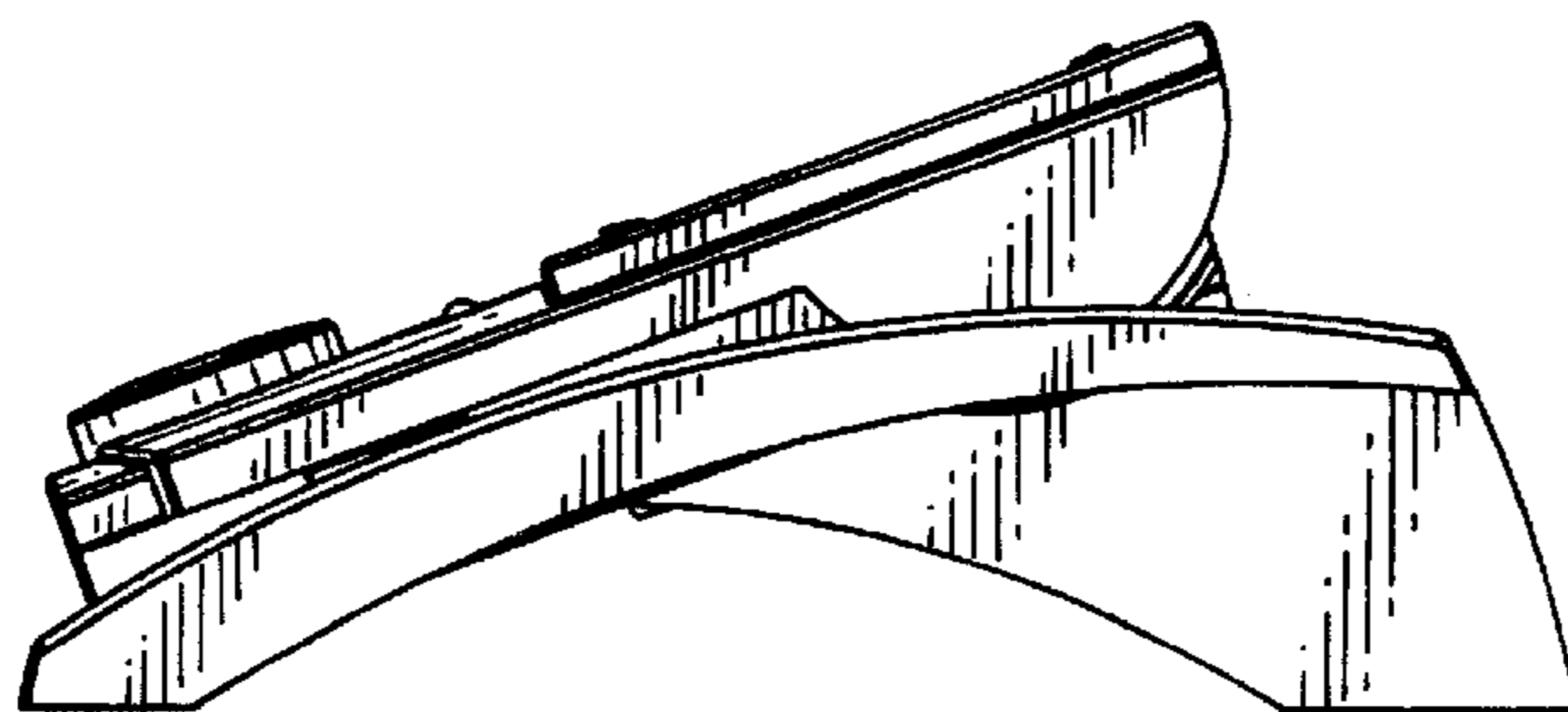

FIG. 7

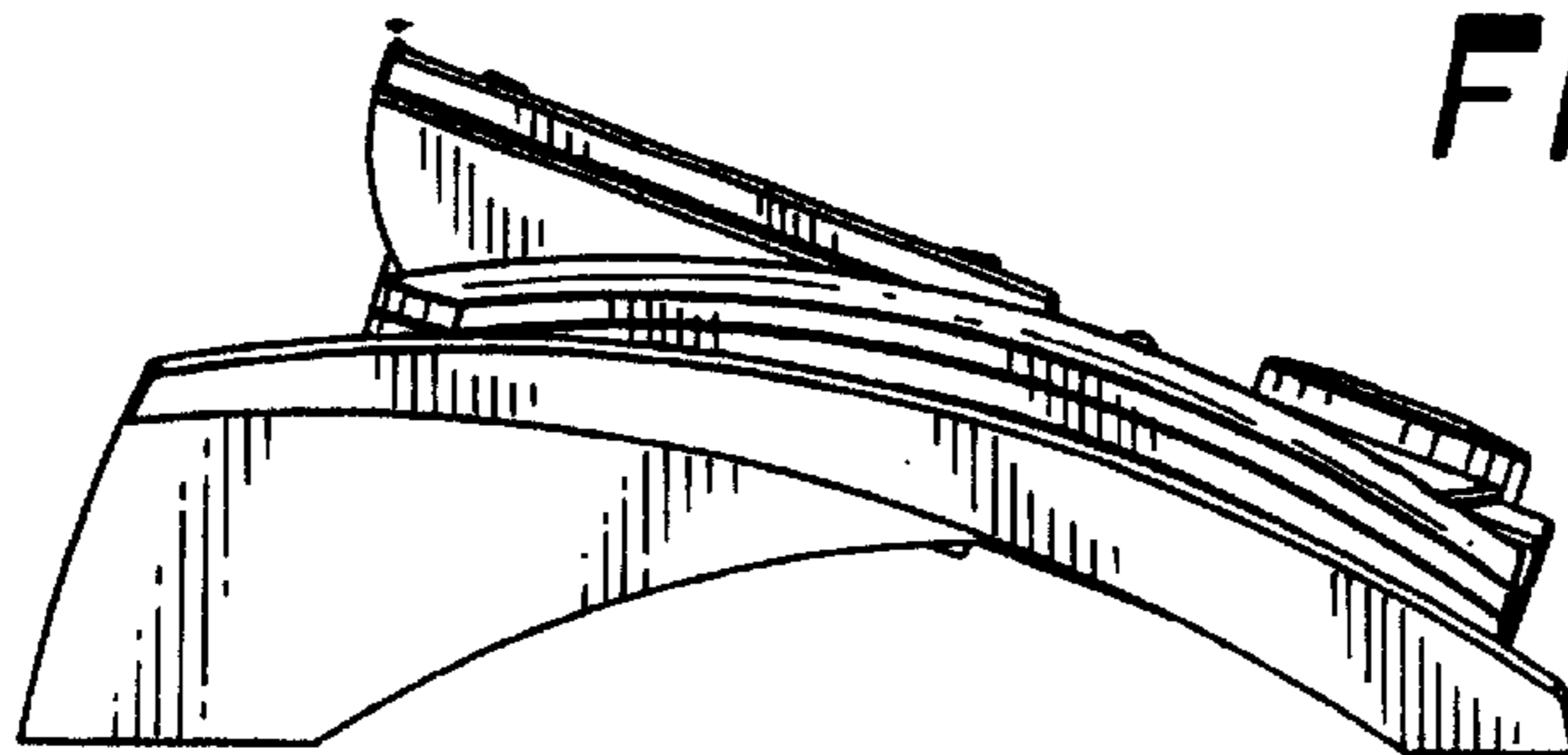

FIG. 8

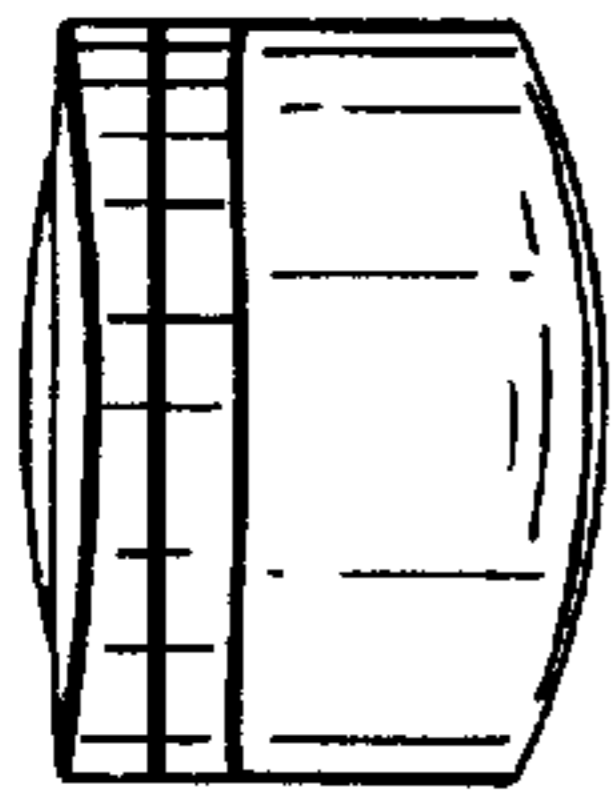

FIG. 13

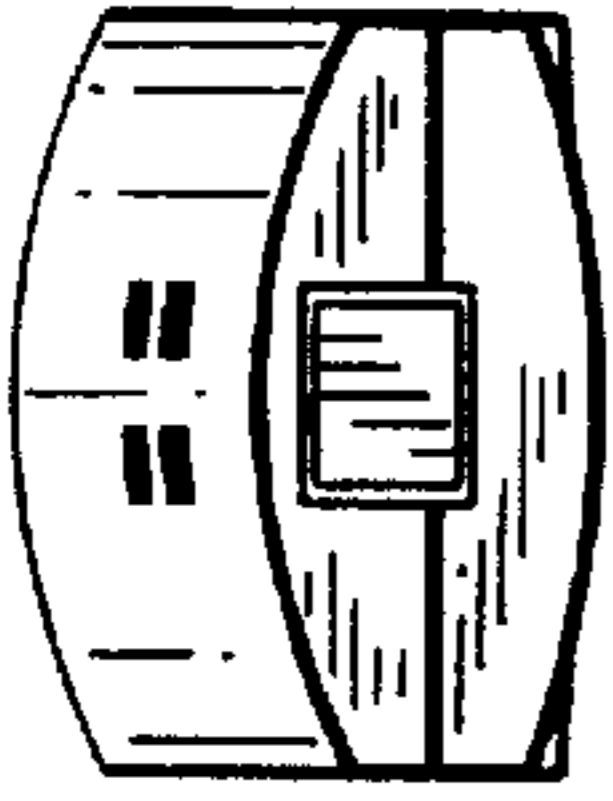

FIG. 14

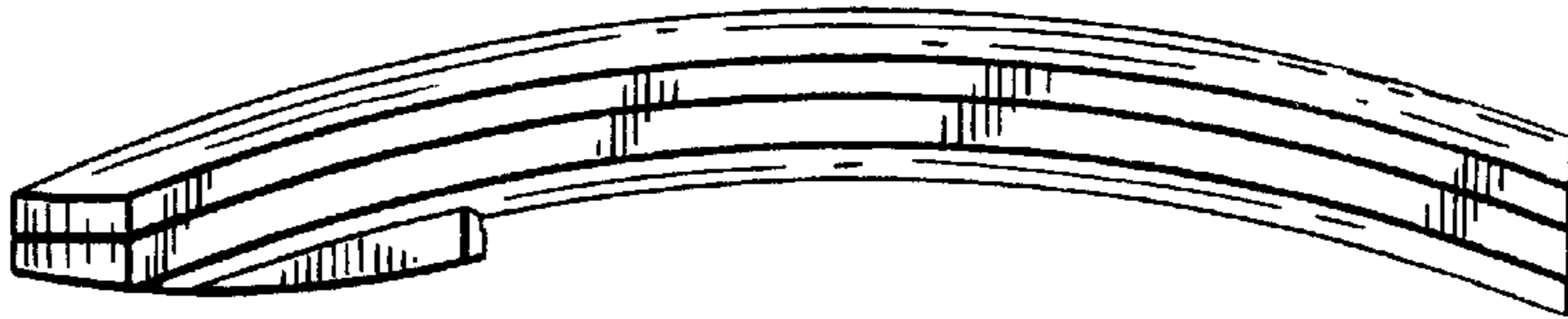

FIG. 9

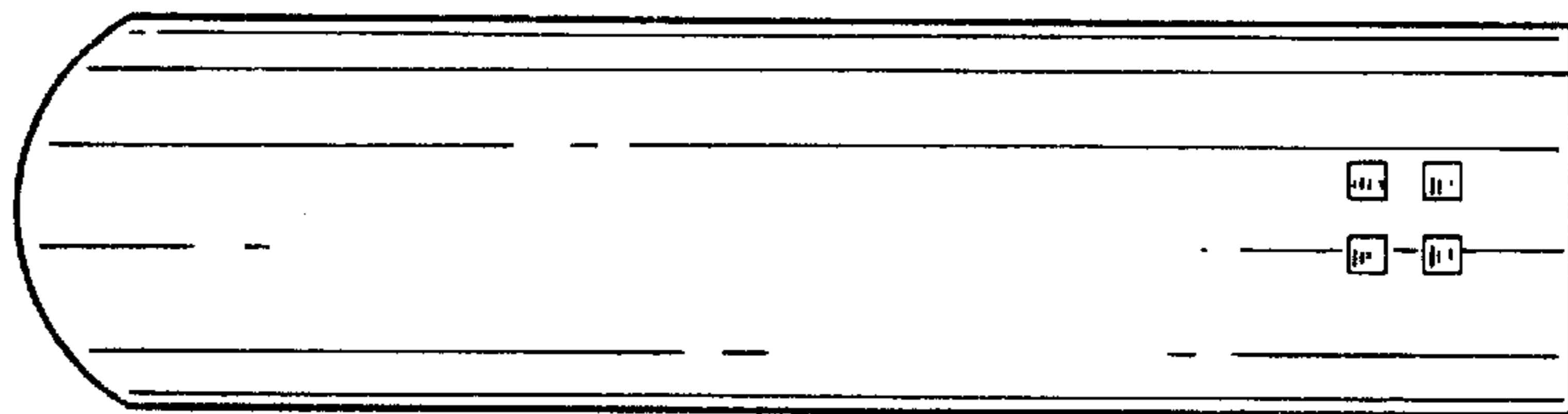

FIG. 10



FIG. 11

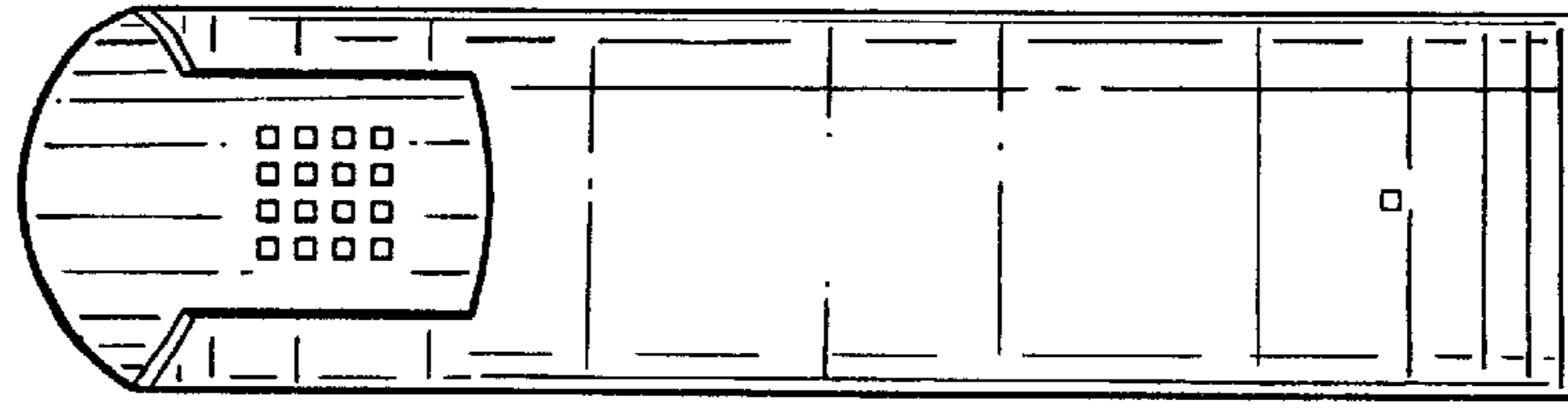

FIG. 12