



US00D418418S

United States Patent [19]
Wadsworth

[11] **Patent Number: Des. 418,418**
[45] **Date of Patent: ** Jan. 4, 2000**

[54] **DISPENSER HEAD FOR MANUAL DISPENSER**

[75] Inventor: **Ronald Wadsworth**, Cambria, Calif.

[73] Assignee: **Calmar Inc.**, Industry, Calif.

[**] Term: **14 Years**

[21] Appl. No.: **29/104,037**

[22] Filed: **Apr. 27, 1999**

[51] **LOC (7) Cl.** **09-07**

[52] **U.S. Cl.** **D9/448**

[58] **Field of Search** D9/300, 440, 447,
D9/448, 449, 450; 222/153.11, 153.12,
153.13, 153.14, 320, 321.1, 321.2, 321.3,
321.4, 321.5, 321.6, 321.7, 321.8, 321.9,
324

[56] **References Cited**

U.S. PATENT DOCUMENTS

D. 285,652	9/1986	Brown	D9/300
D. 332,913	2/1993	Carroll	D9/300
D. 336,845	6/1993	Carroll et al.	D9/300
D. 337,496	7/1993	Laubach et al.	D9/300
D. 352,657	11/1994	Gonda et al.	D9/300
D. 370,409	6/1996	Lathrop et al.	D9/300
D. 372,860	8/1996	Lathrop et al.	D9/300
D. 375,454	11/1996	Lathrop et al.	D9/300

D. 389,407	1/1998	Mascitelli	D9/448
D. 407,304	3/1999	Crawford	D9/300 X
5,445,299	8/1995	Harriman	222/153.13
5,715,973	2/1998	Foster et al.	222/153.13
5,868,286	2/1999	Mascitelli	222/321.9

FOREIGN PATENT DOCUMENTS

DM/034627 6/1995 WIPO .

Primary Examiner—Cathron B. Matta
Attorney, Agent, or Firm—Watson Cole Grindle Watson, P.L.L.C.

[57] **CLAIM**

The ornamental design for a dispenser head for manual dispenser, as shown and described.

DESCRIPTION

FIG. 1 is a left side elevational view of the dispenser head for a manual dispenser showing my new design, the right side elevational view being a mirror image; FIG. 2 is a front elevational view thereof; FIG. 3 is a rear elevational view thereof; FIG. 4 is a top plane view thereof; and, FIG. 5 is a sectional view taken along the line 5—5 of FIG. 1.

The broken lines shown in FIGS. 1–5 area for illustrative purposes only and form no part of the claimed design.

1 Claim, 1 Drawing Sheet

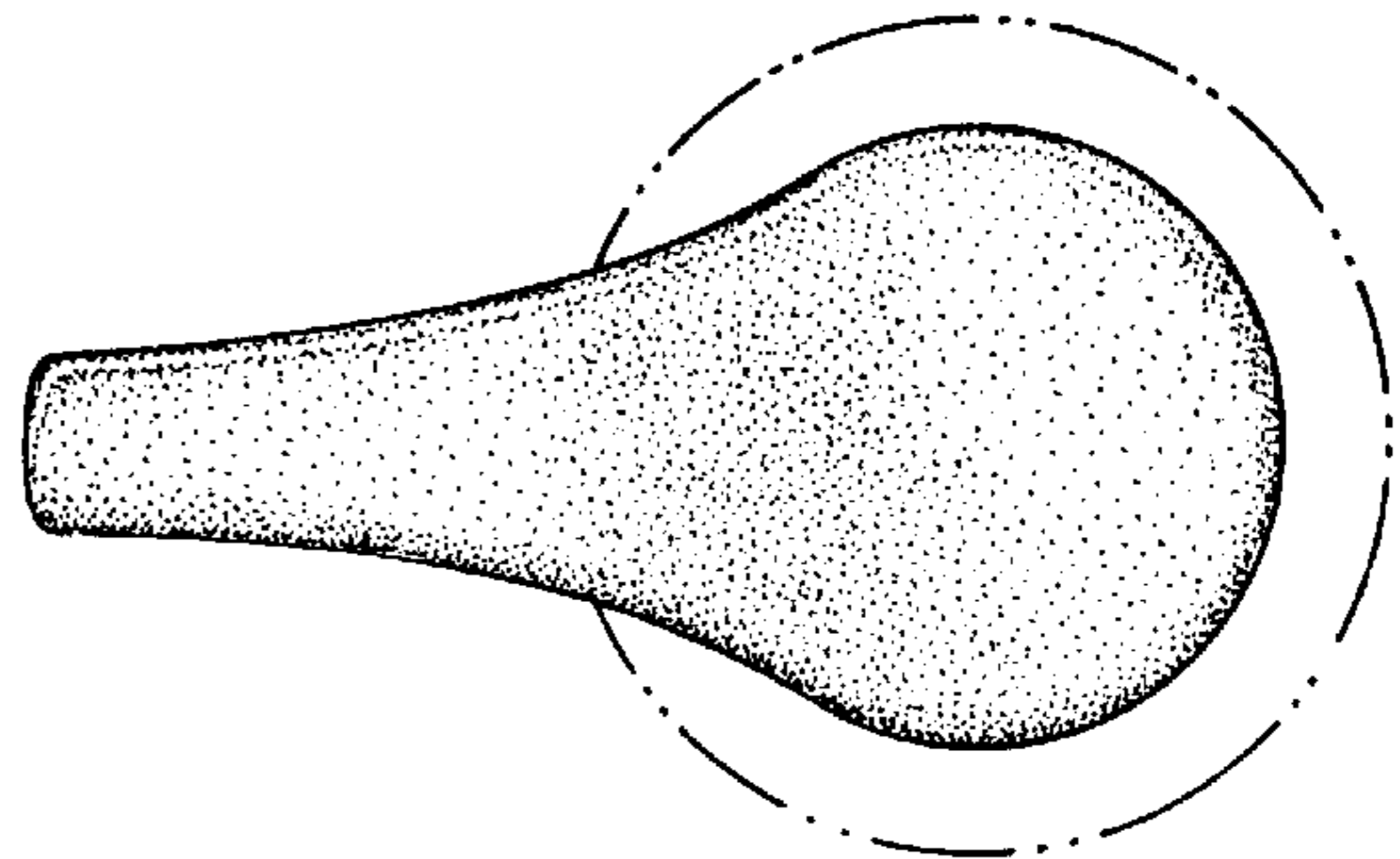
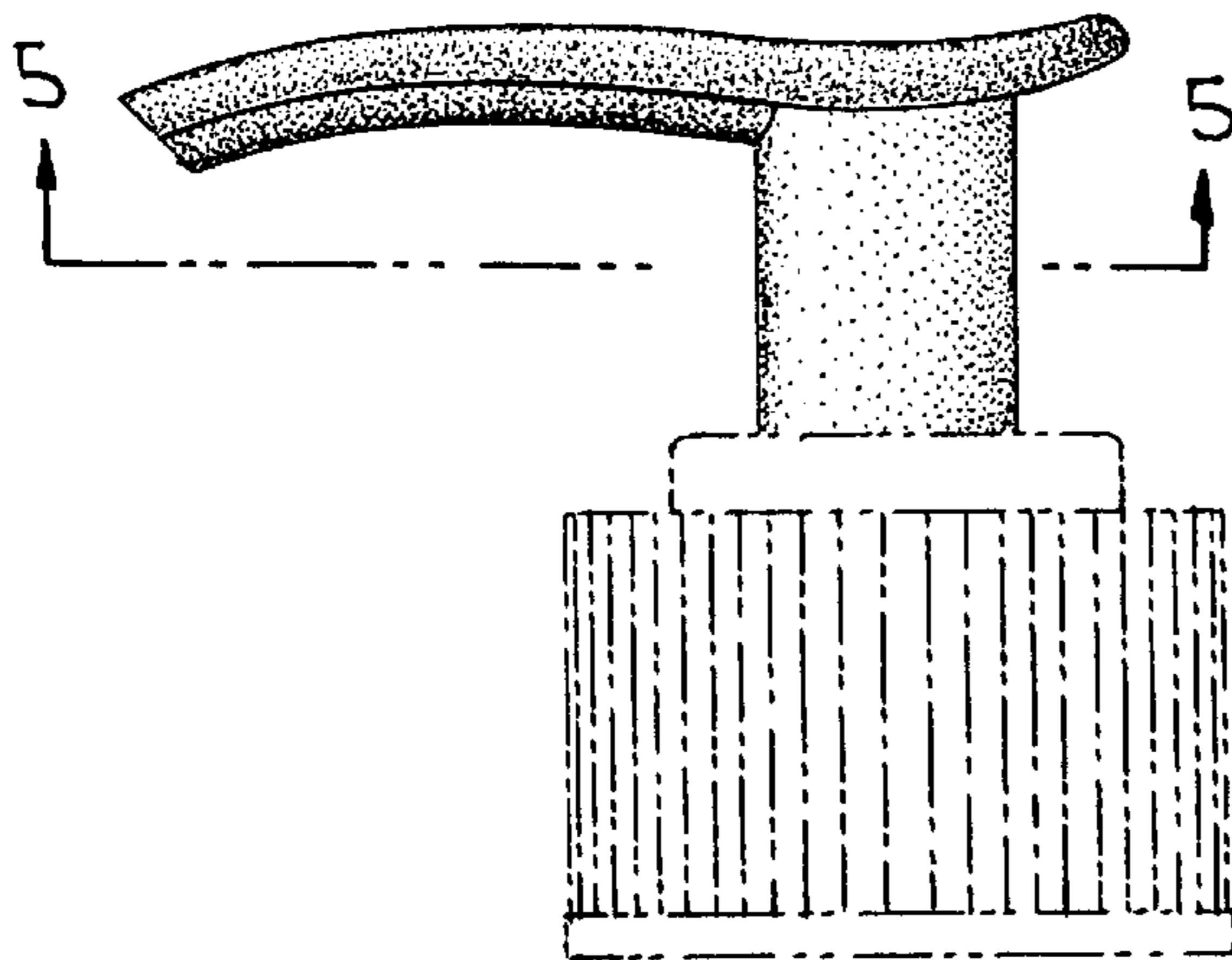

FIG. 2

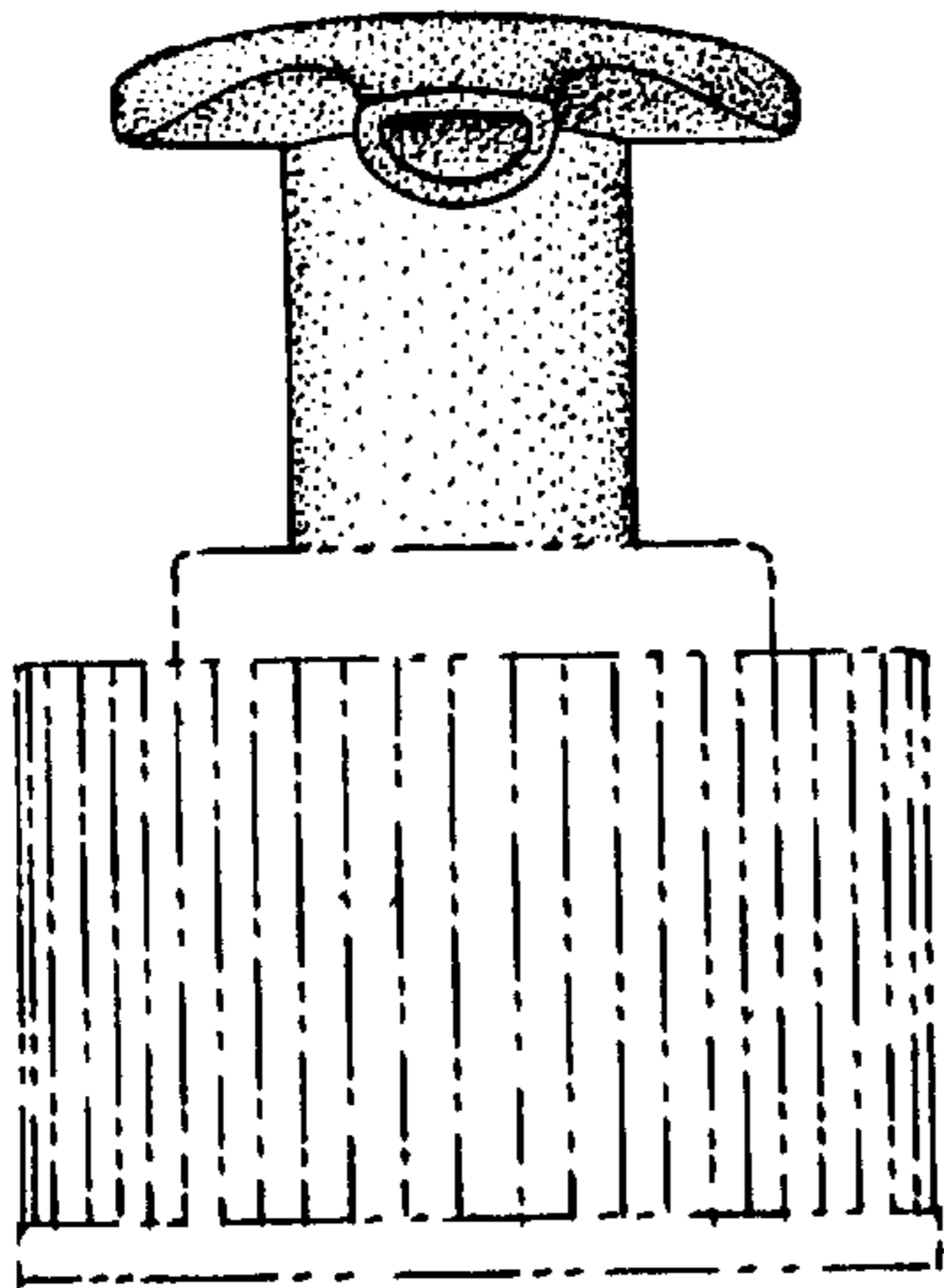

FIG. 1

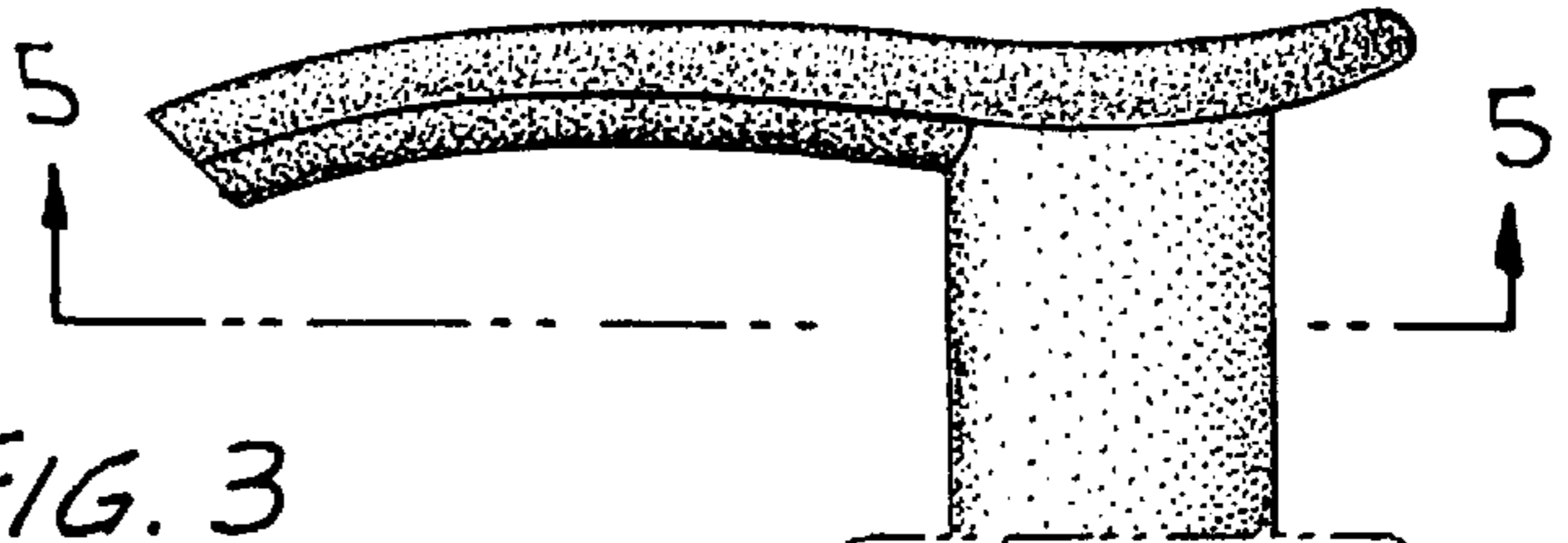

FIG. 3

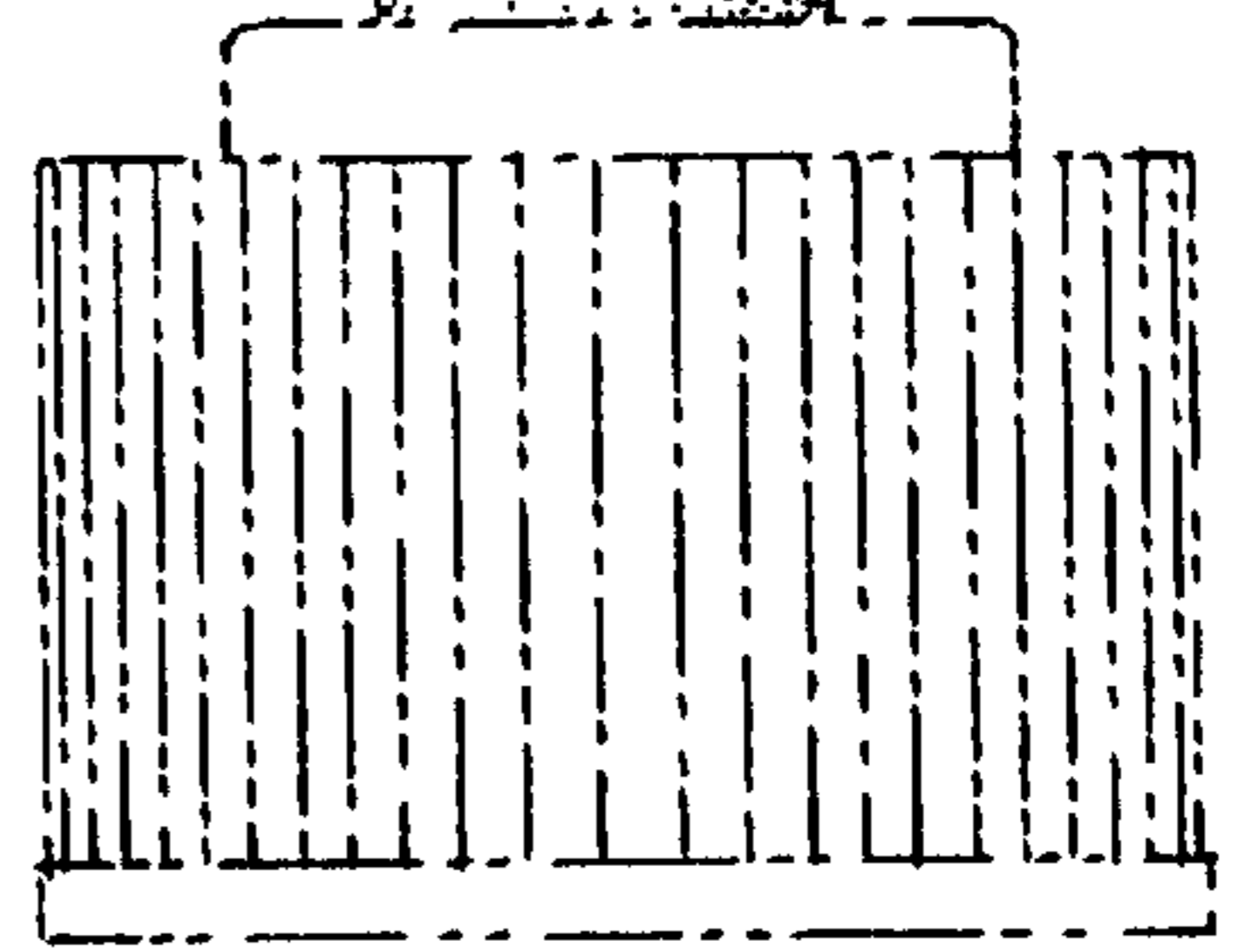
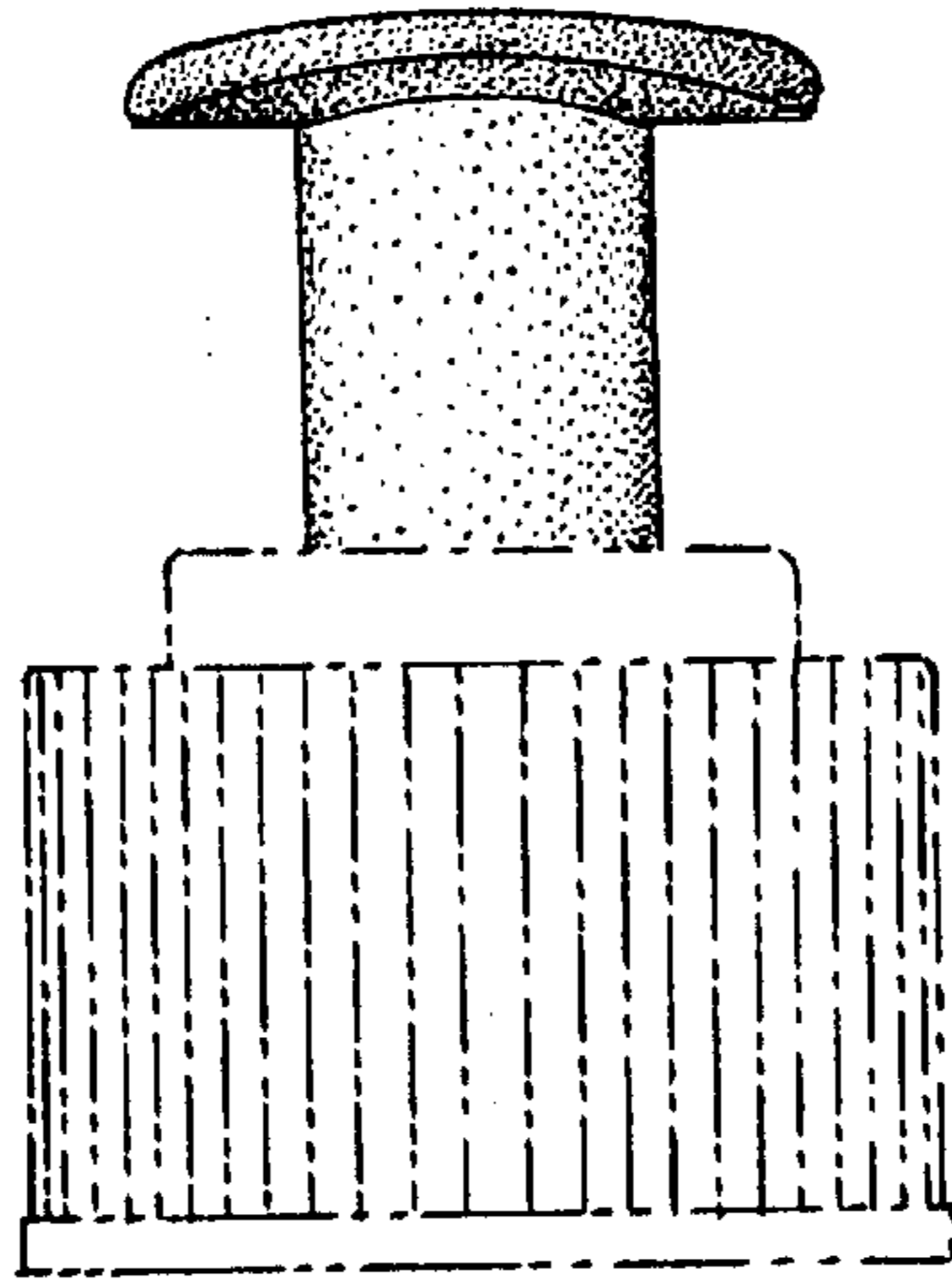

FIG. 4

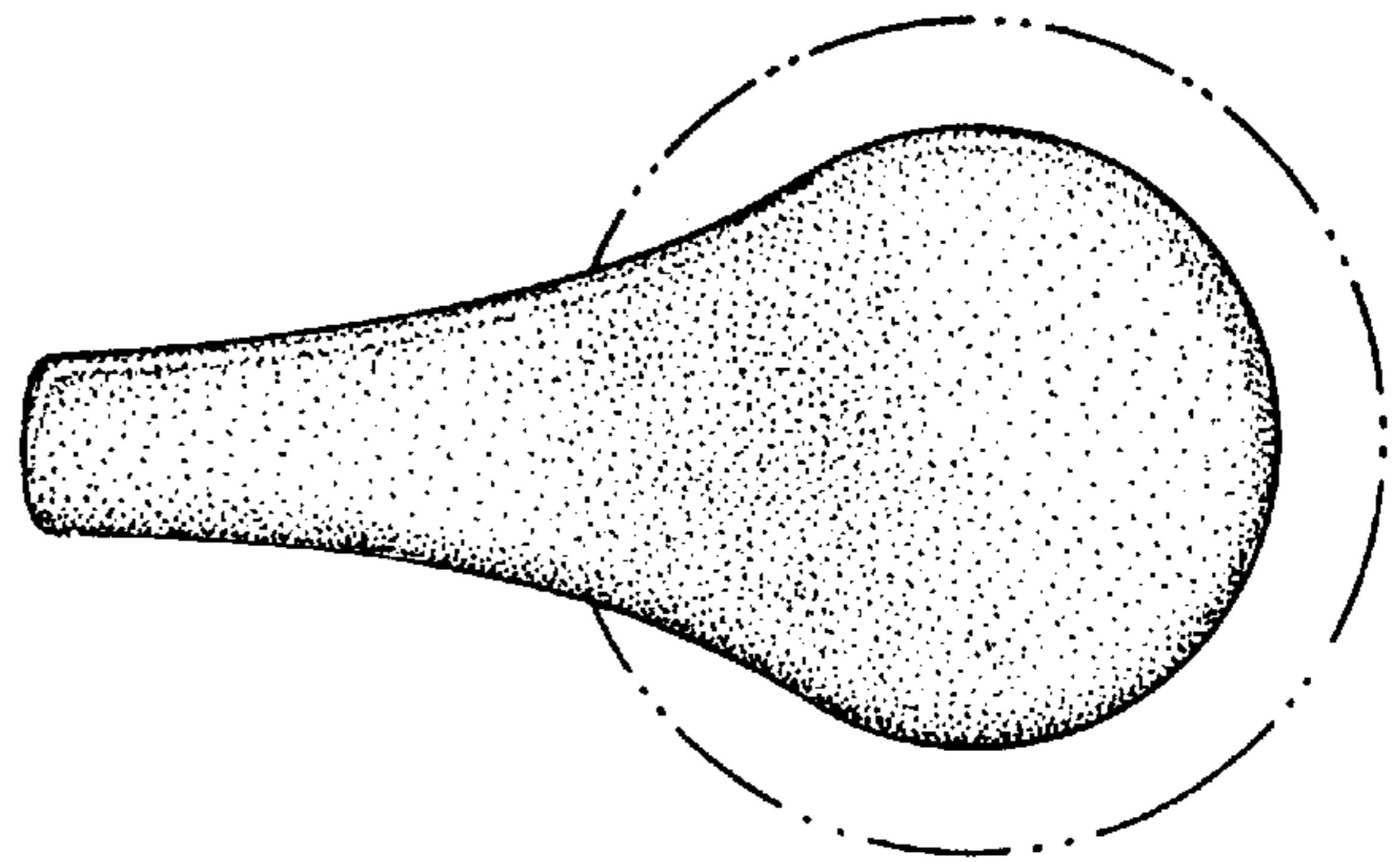

FIG. 5

