



US00D418410S

United States Patent [19] Smith

[11] **Patent Number: Des. 418,410**
[45] **Date of Patent: ** Jan. 4, 2000**

[54] **STORAGE CONTAINER**
[75] Inventor: **Norman John Smith**, Los Angeles, Calif.
[73] Assignee: **Moldex-Metric, Inc.**, Culver City, Calif.
[**] Term: **14 Years**
[21] Appl. No.: **29/095,456**
[22] Filed: **Oct. 23, 1998**
[51] **LOC (7) Cl.** **09-03**
[52] **U.S. Cl.** **D9/430**
[58] **Field of Search** D9/337-338, 341, D9/345, 424-425, 432, 445; 220/833, 835, 837, 839

4,244,470 1/1981 Burnham 220/4.23
4,512,474 4/1985 Harding 220/4.23
5,300,748 4/1994 Colombo 220/387
5,584,408 12/1996 Orkisz 220/4.23
5,806,704 9/1998 Jamison 220/792

Primary Examiner—Ted Shooman
Assistant Examiner—Carol Rademaker
Attorney, Agent, or Firm—Charles H. Schwartz

[57] CLAIM

The ornamental design for a storage container, as shown and described.

DESCRIPTION

FIG. 1 is a front perspective view of a storage container showing my new design;
FIG. 2 is a back elevational view thereof;
FIG. 3 is a top plan view thereof;
FIG. 4 is a side elevational view thereof; the opposite side being a mirror image;
FIG. 5 is a front elevational view thereof; and,
FIG. 6 is a bottom plan view thereof.

[56] **References Cited**
U.S. PATENT DOCUMENTS
D. 305,616 1/1990 Johnson D9/445
2,739,751 3/1956 Bailey 426/120
2,915,214 12/1959 Frankel 220/4.43

1 Claim, 3 Drawing Sheets

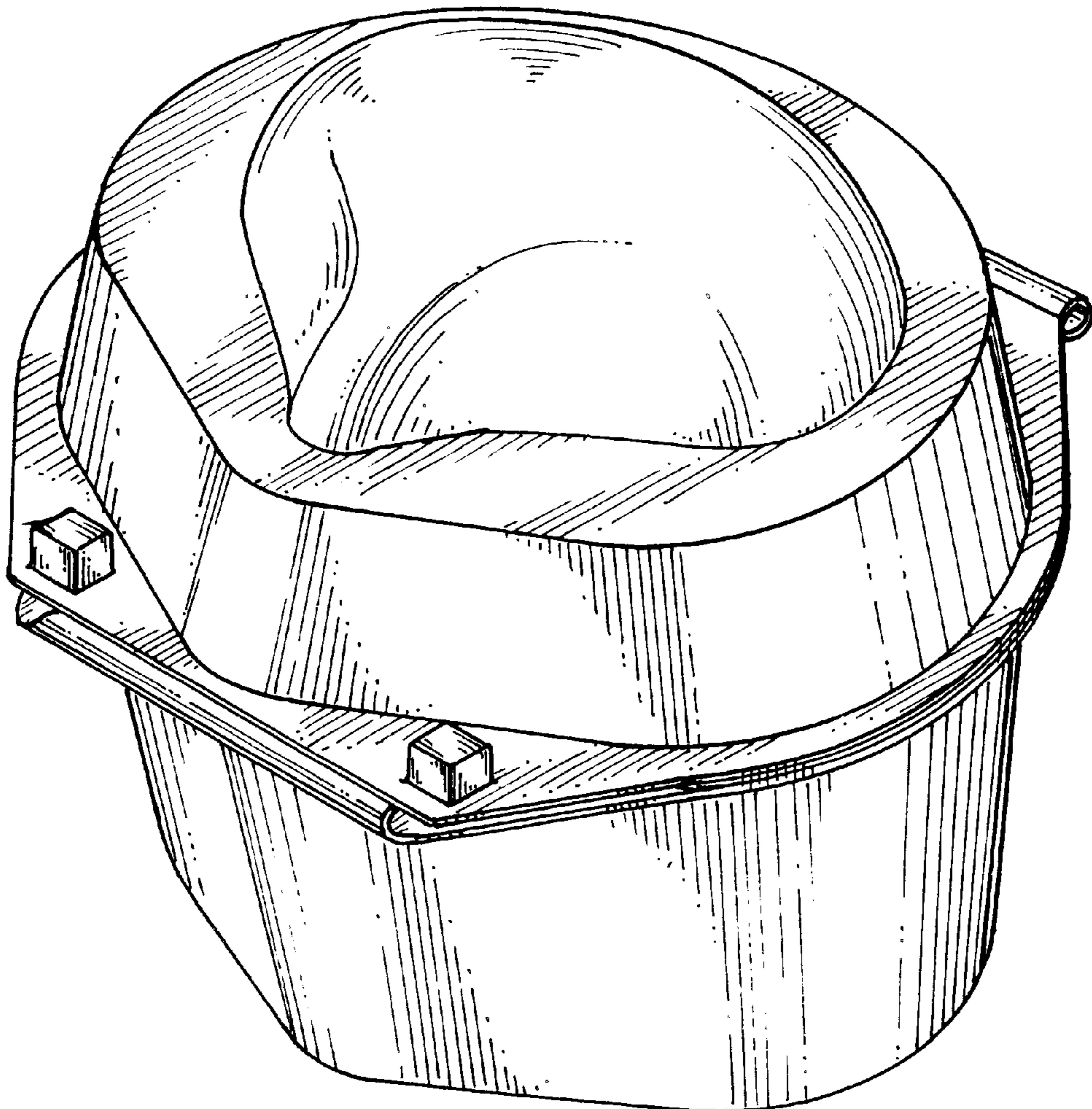

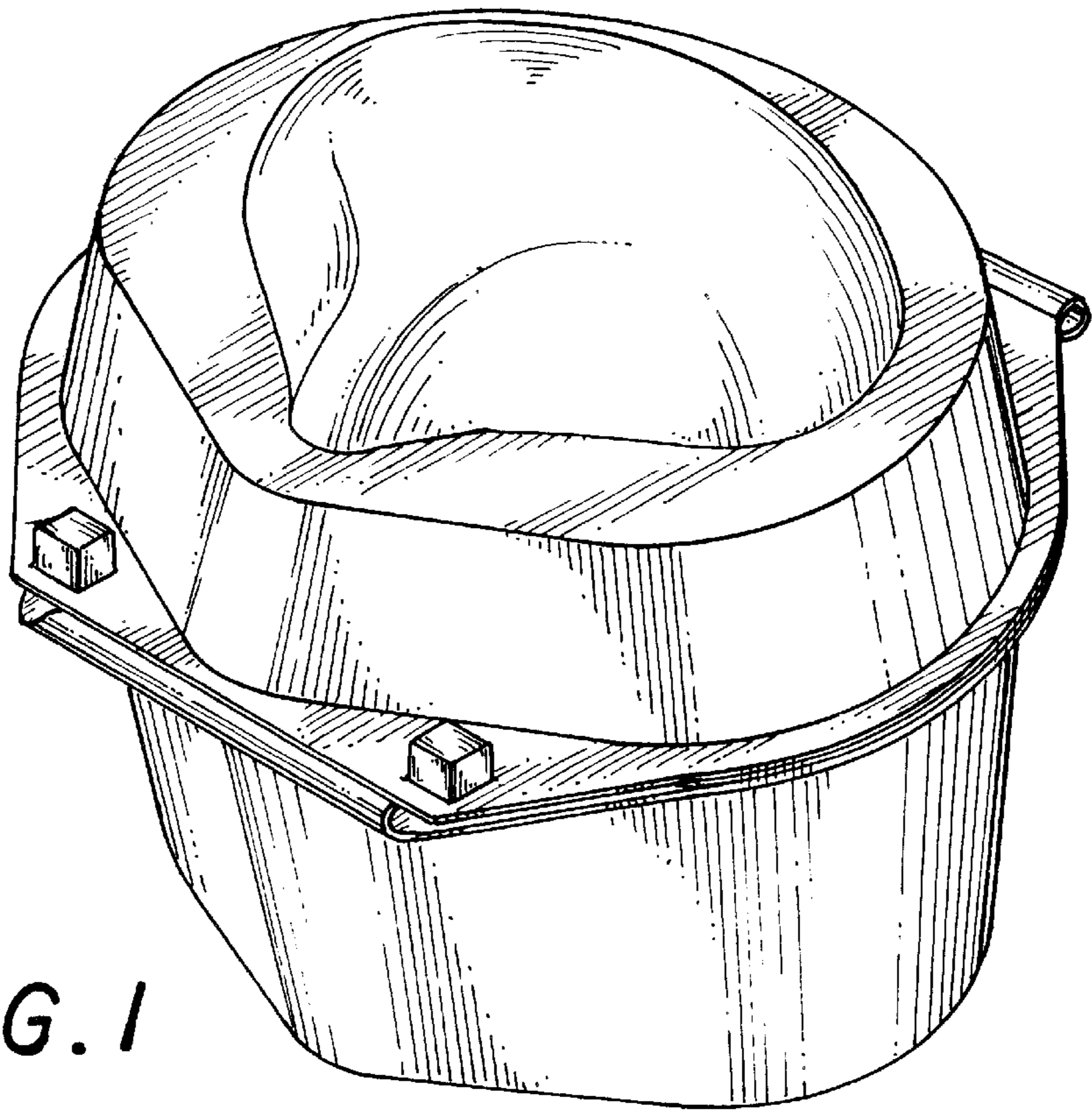

FIG. 1

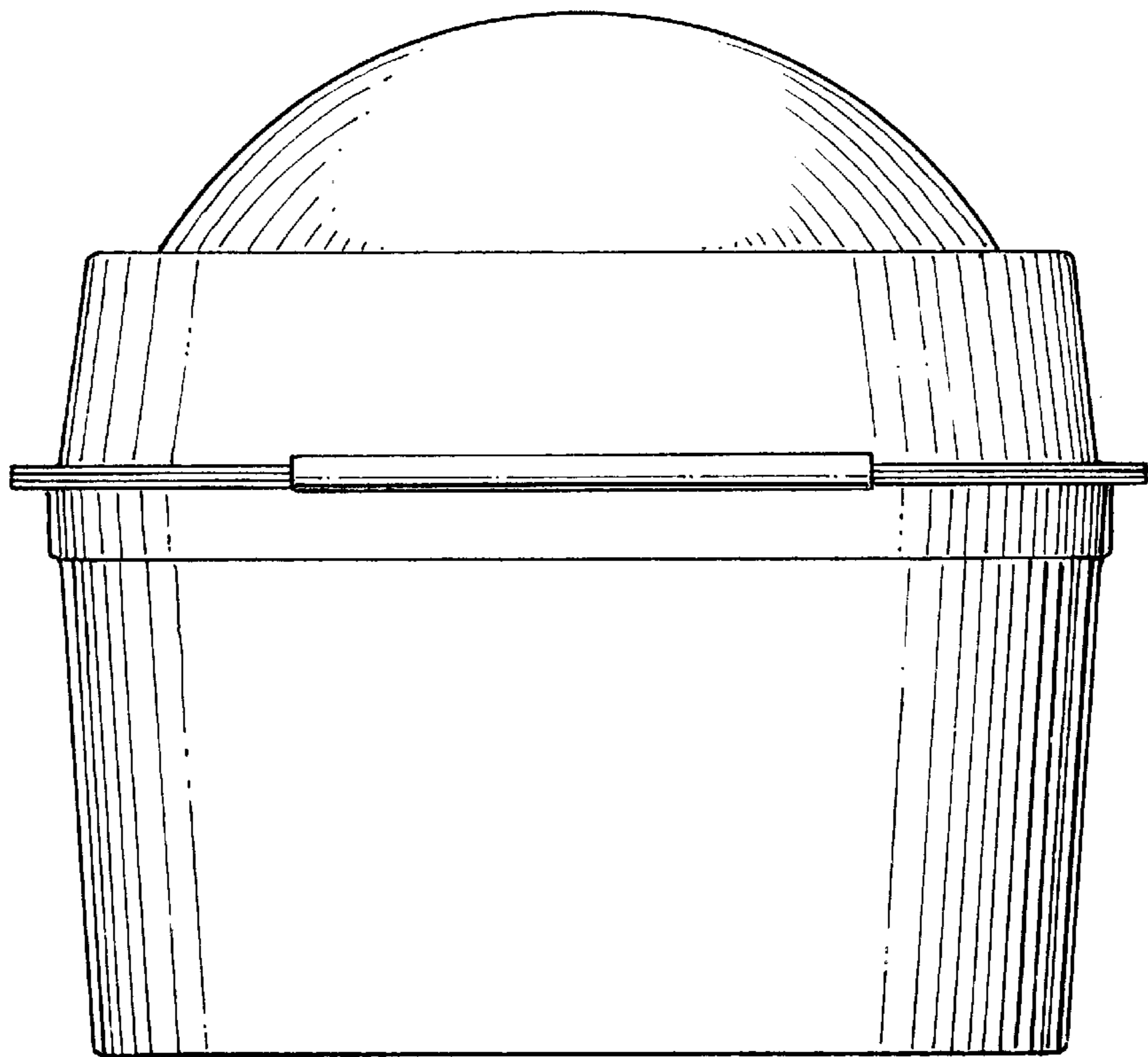

FIG. 2

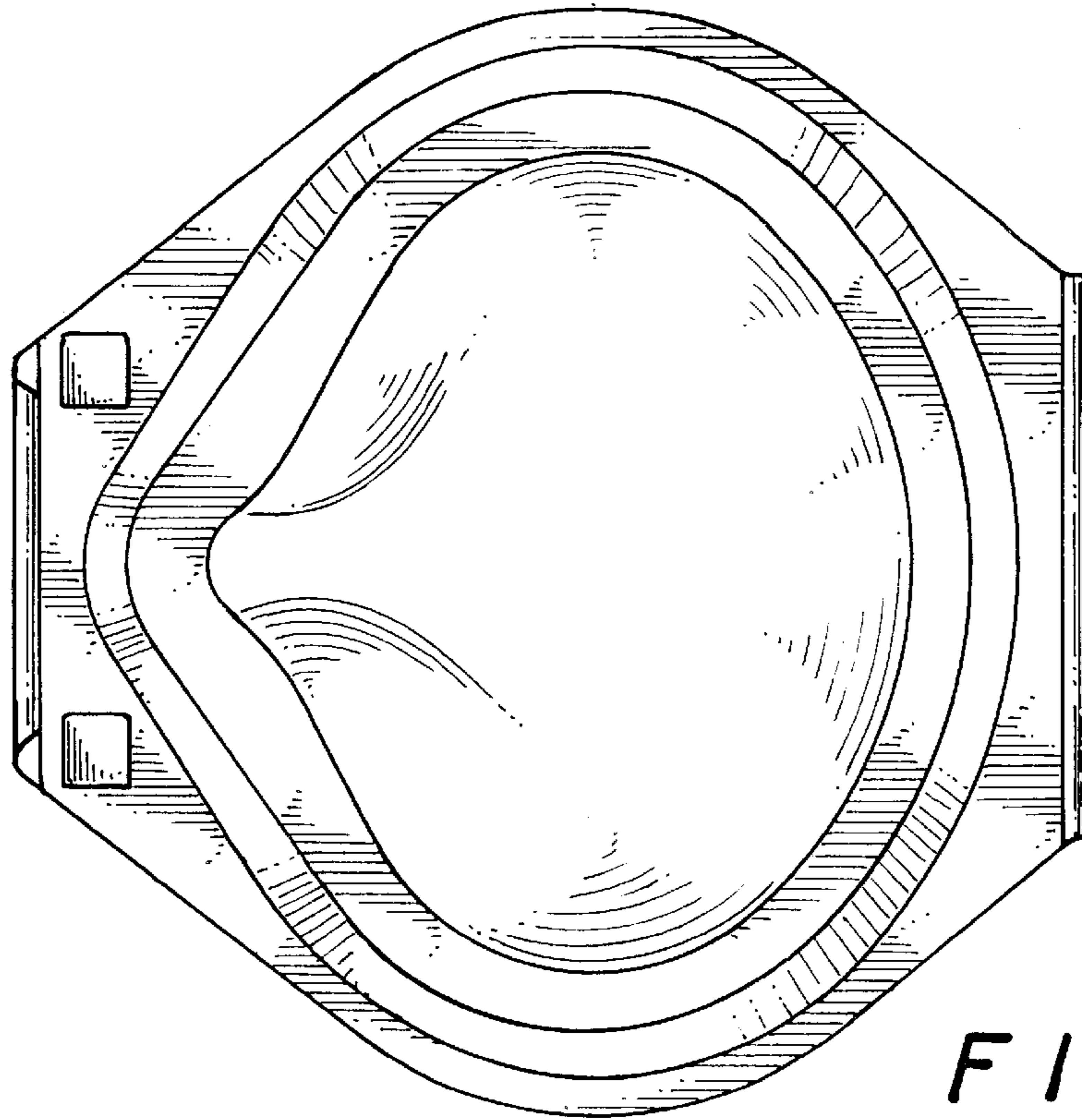
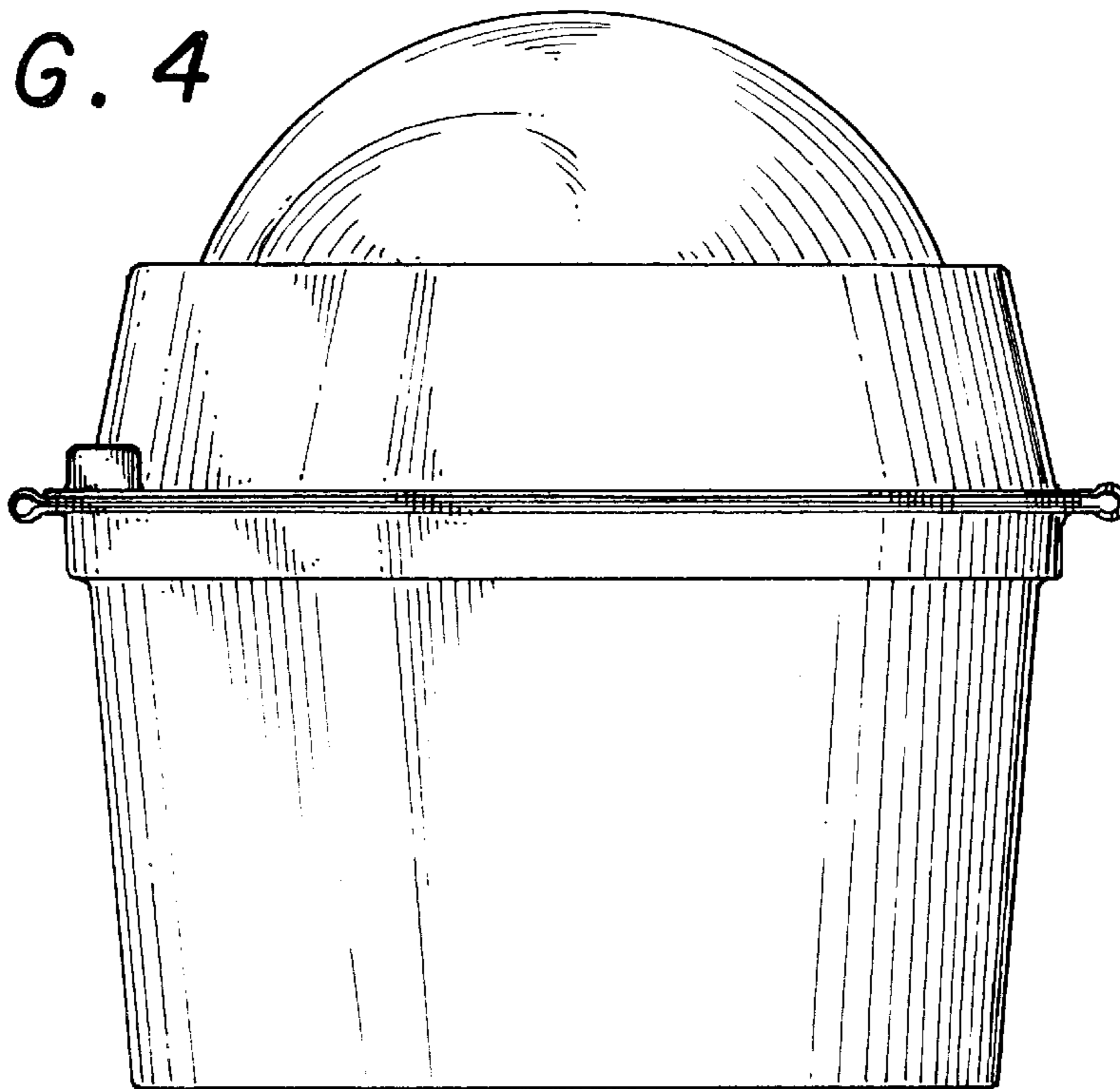

FIG. 3

FIG. 4



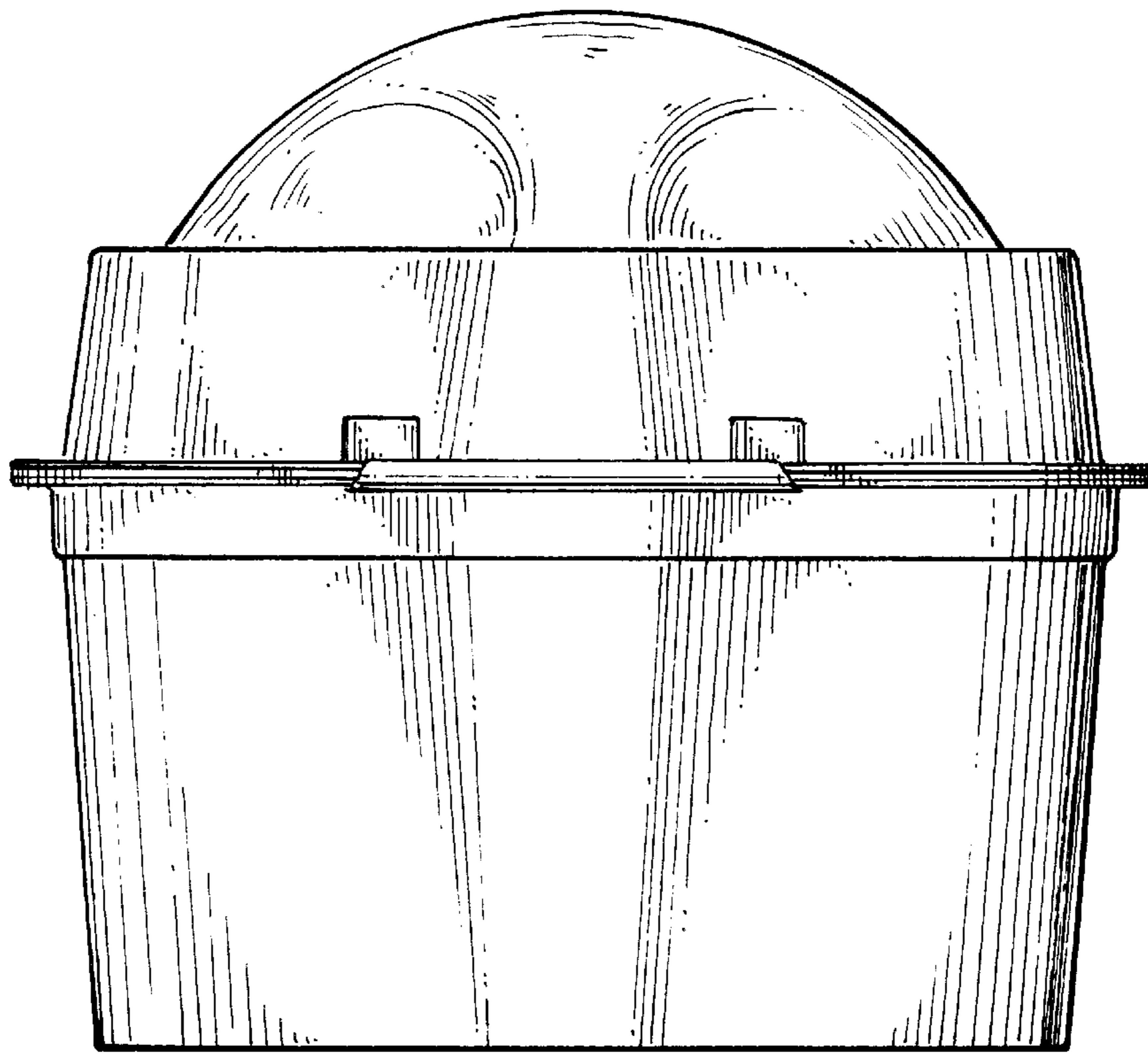

FIG. 5

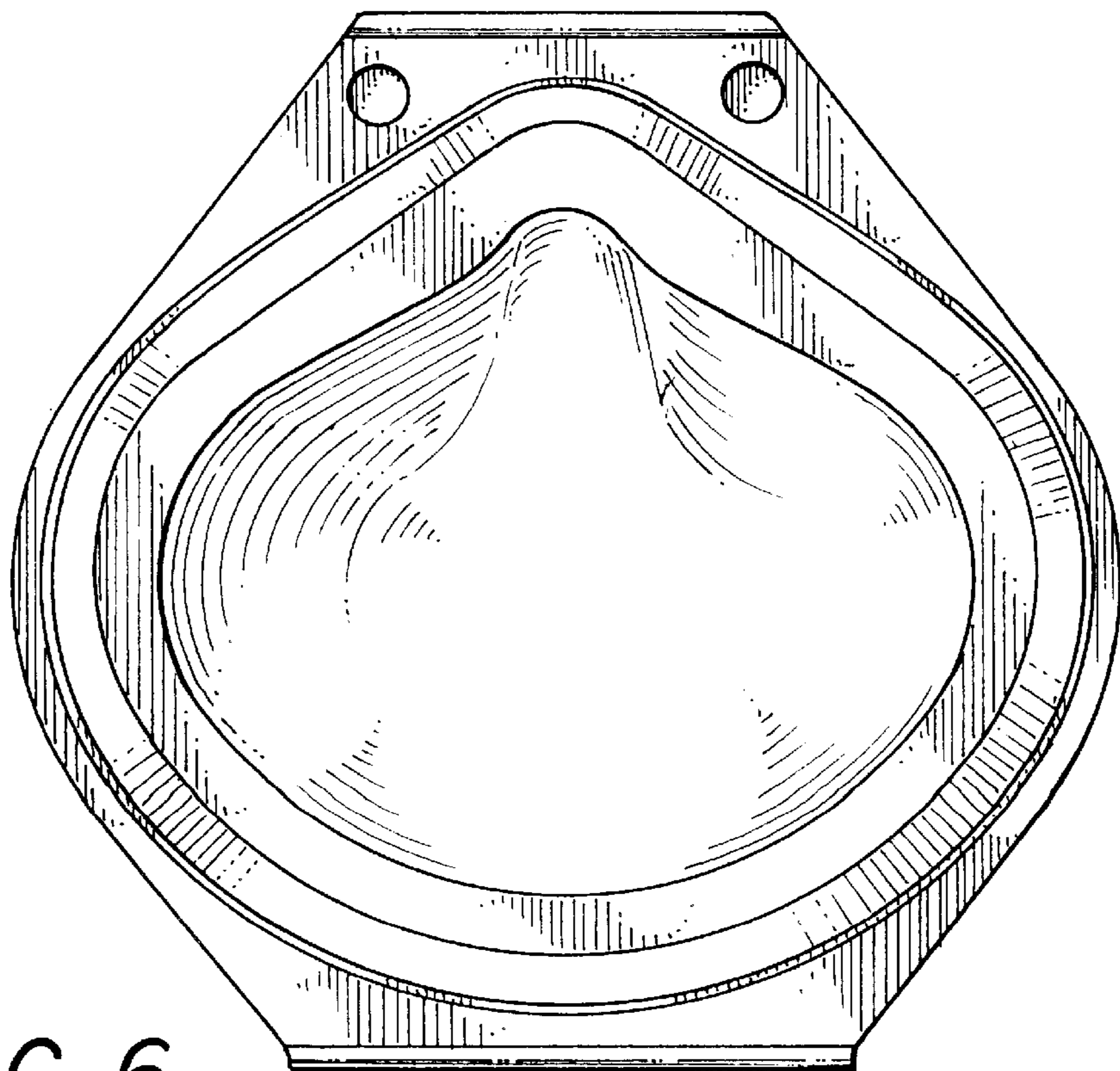

FIG. 6