



US00D418406S

United States Patent [19] Liao

[11] **Patent Number: Des. 418,406**
[45] **Date of Patent: ** Jan. 4, 2000**

[54] **TOOL HOLDER**

5,785,174 7/1998 Chow 206/461 X

[75] Inventor: **Te-Tsun Liao**, Hsin Chuang, Taiwan

OTHER PUBLICATIONS

[73] Assignee: **Taiwan Marst Industry Co., Ltd**, Hsin Chuang, Taiwan

Modern Packaging, p. 300, 1941.
Techform Inc, Nov. 1982.

[**] Term: **14 Years**

Primary Examiner—Prabhakar Deshmukh
Attorney, Agent, or Firm—Ladas & Parry

[21] Appl. No.: **29/089,186**

[57] CLAIM

[22] Filed: **Jun. 9, 1998**

The ornamental design for tool holder, as shown and described.

[51] **LOC (7) Cl.** **09-07**

[52] **U.S. Cl.** **D9/415; D9/347; D9/341**

DESCRIPTION

[58] **Field of Search** D9/415, 418, 341,
D9/347, 337, 414; 206/461-471, 495, 806,
207, 349, 372-379

FIG. 1 is a perspective view of a tool holder in accordance with the present design;
FIG. 2 is a front elevational view thereof;
FIG. 3 is a rear elevational view thereof;
FIG. 4 is a top plan view thereof;
FIG. 5 is a bottom plan view thereof;
FIG. 6 is a left side elevational view thereof;
FIG. 7 is a right side elevational view thereof; and,
FIG. 8 is perspective view thereof; shown in an open position and in the state of use thereof.
The broken line showing of tools is for illustrative purpose only and forms no part of the claim.

[56] References Cited

U.S. PATENT DOCUMENTS

D. 346,114	4/1994	Winston	D9/415
D. 369,547	5/1996	Dahlheimer	D9/415
D. 370,174	5/1996	Bergstedt	D9/415
D. 370,626	6/1996	Pass et al.	D9/415
2,884,127	4/1959	Neary	206/462
2,993,590	7/1961	Denton	206/462 X
4,702,368	10/1987	Jones	206/461 X
5,499,711	3/1996	Kozar	206/372 X
5,730,303	3/1998	Chow	206/372 X

1 Claim, 6 Drawing Sheets

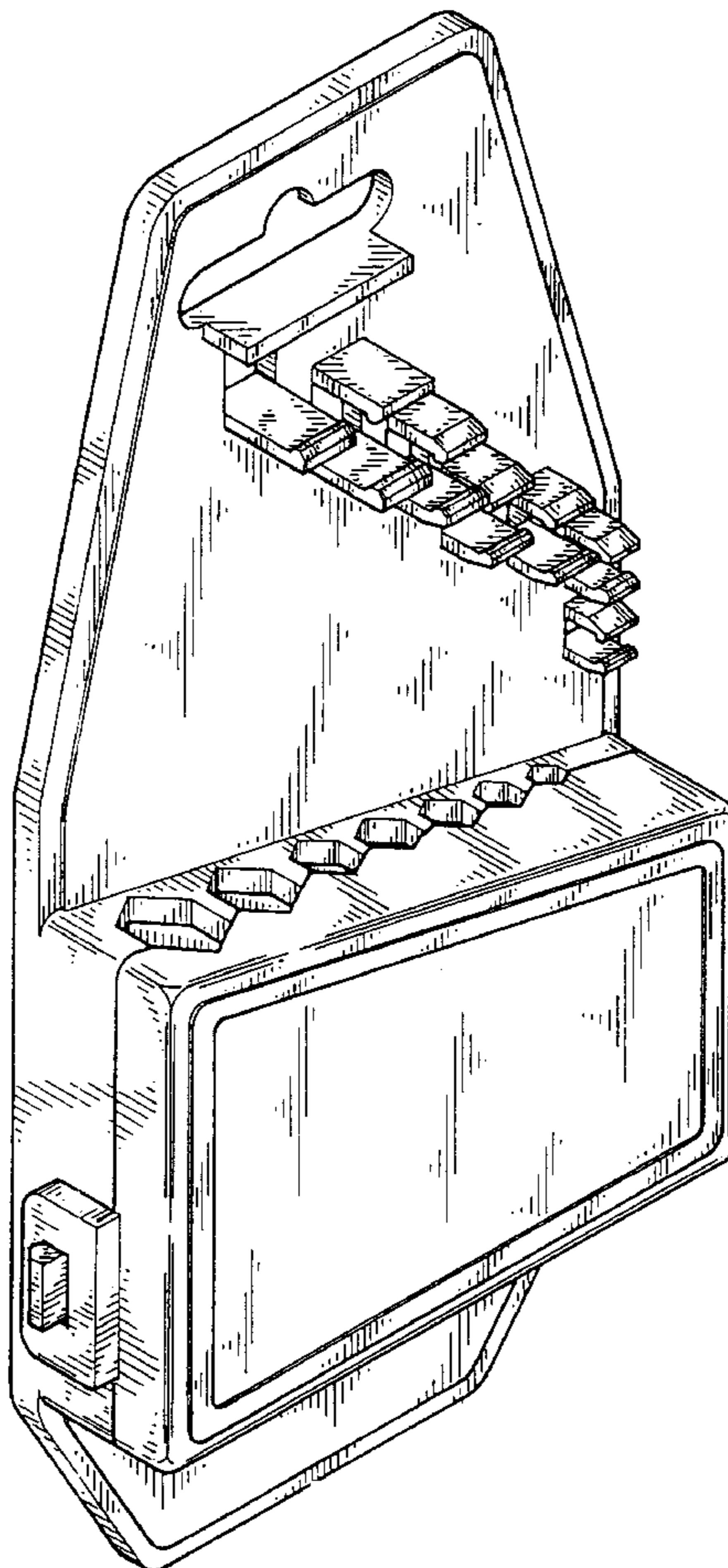

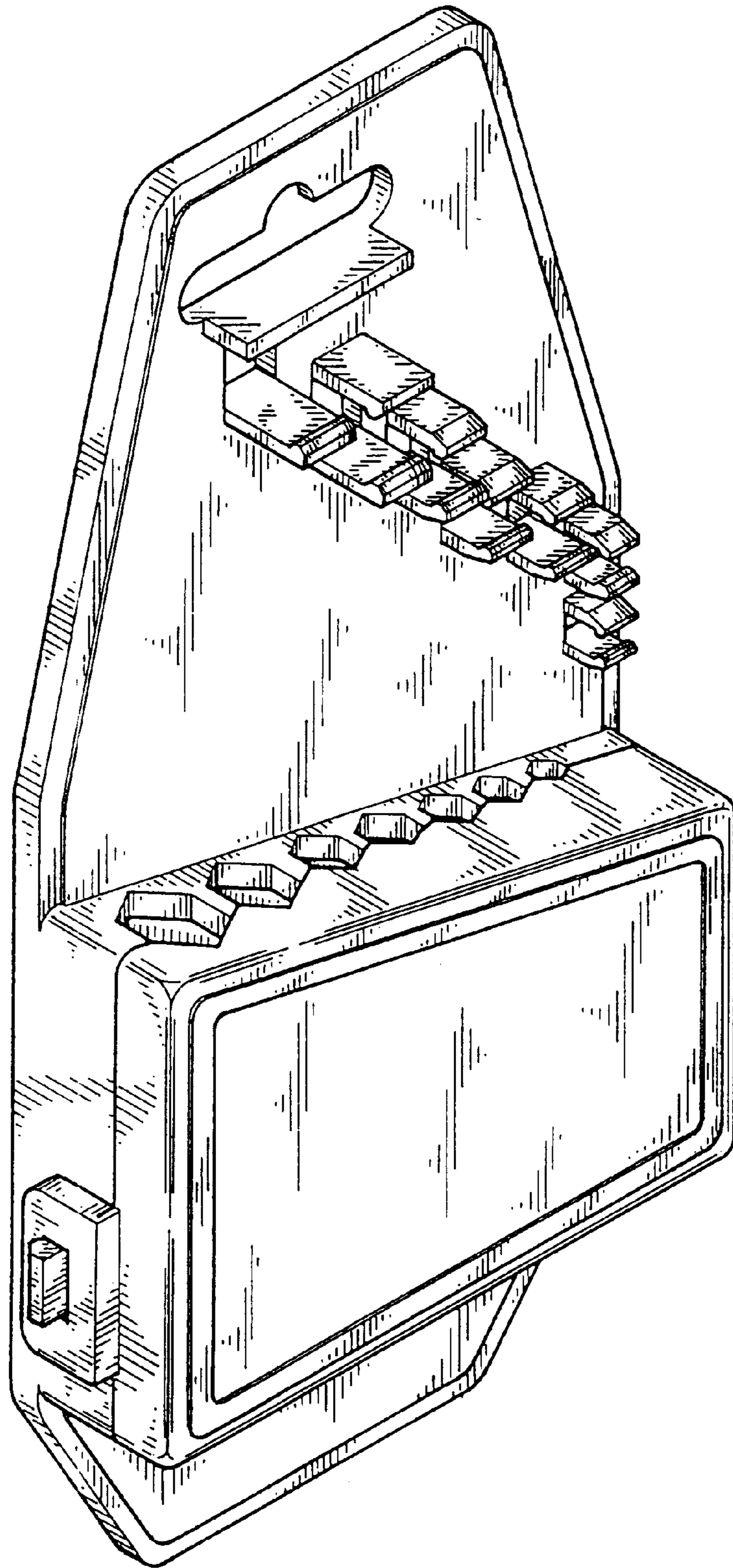

FIG. 1

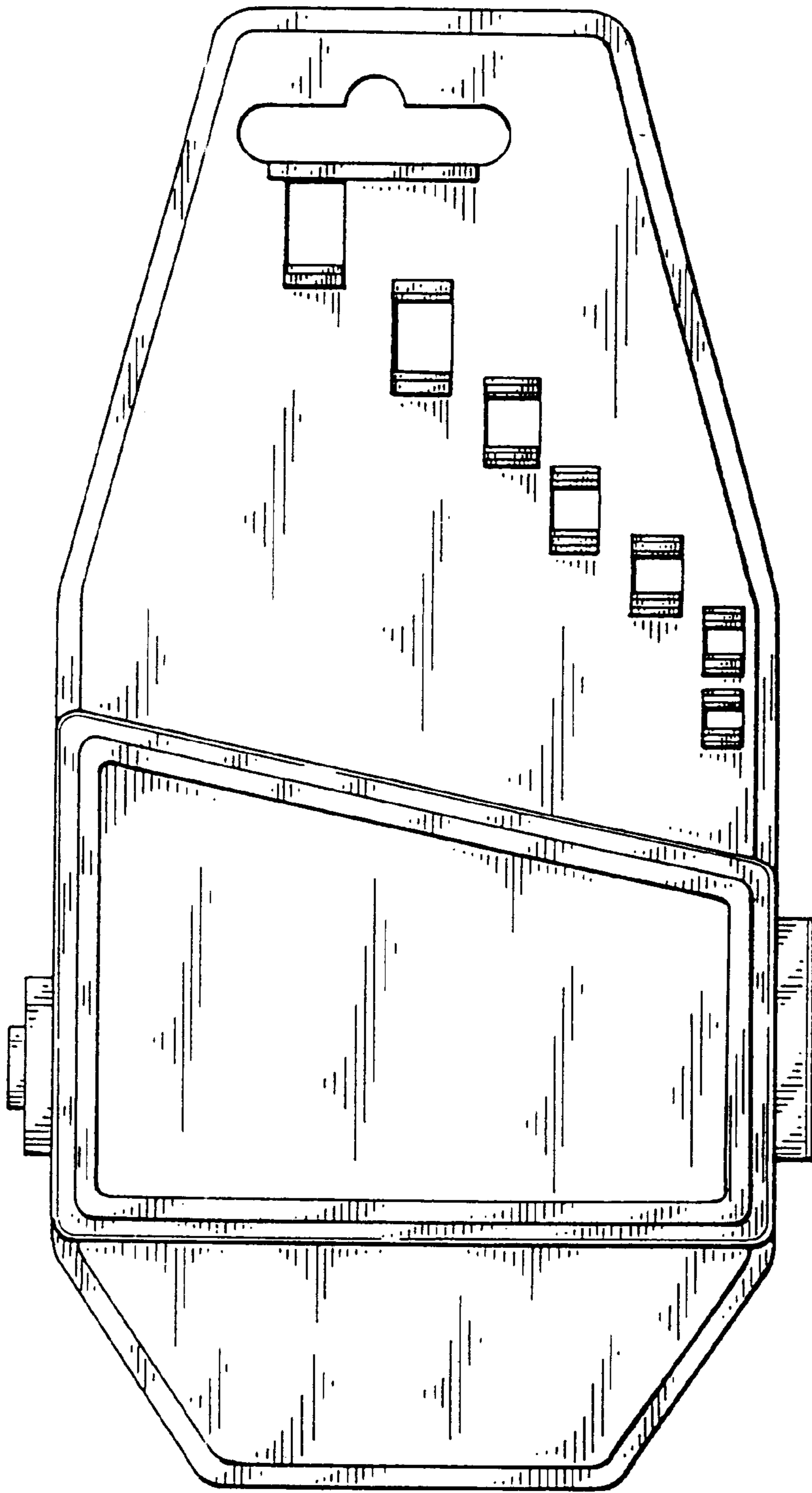

FIG. 2

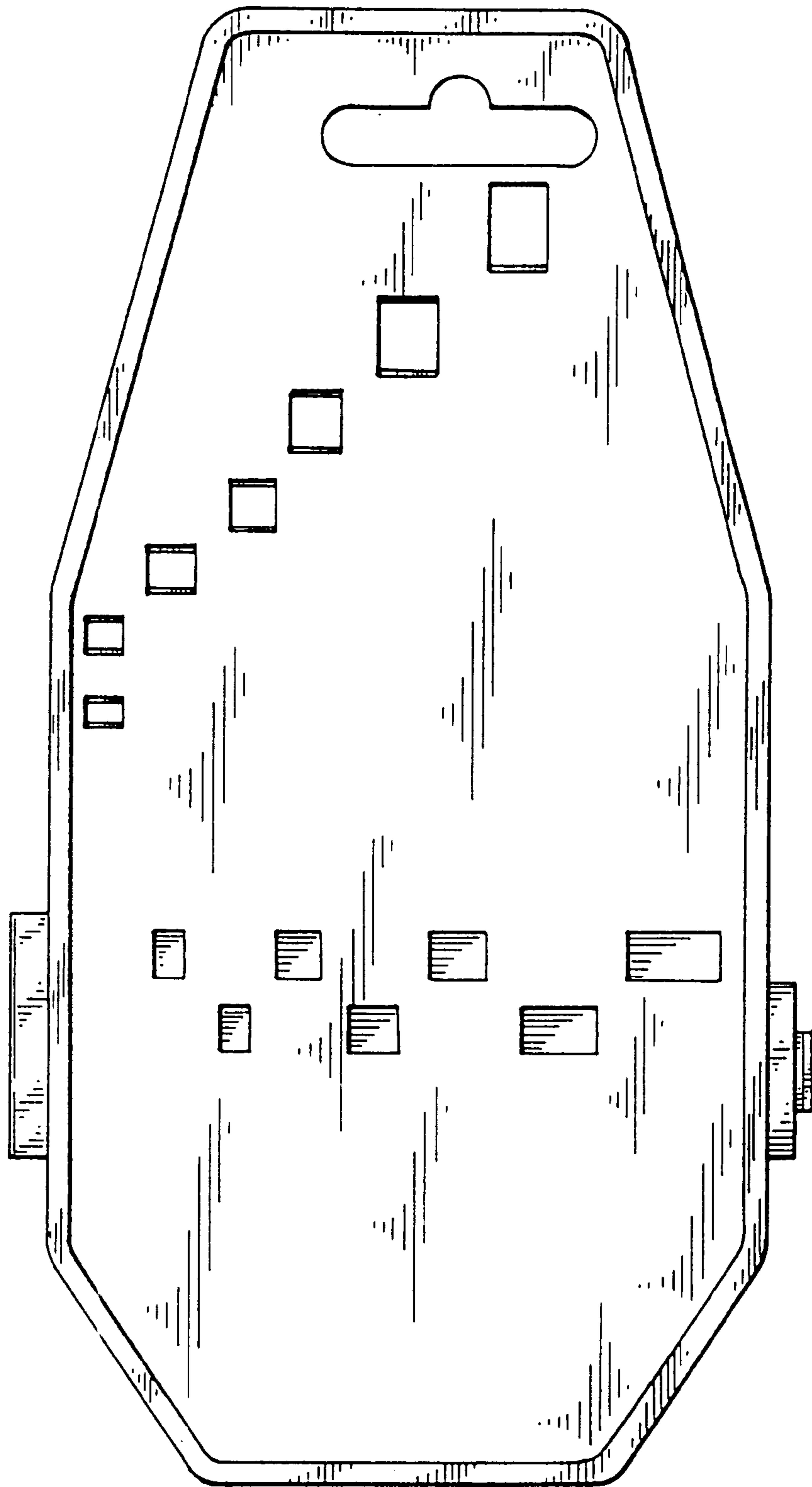

FIG. 3

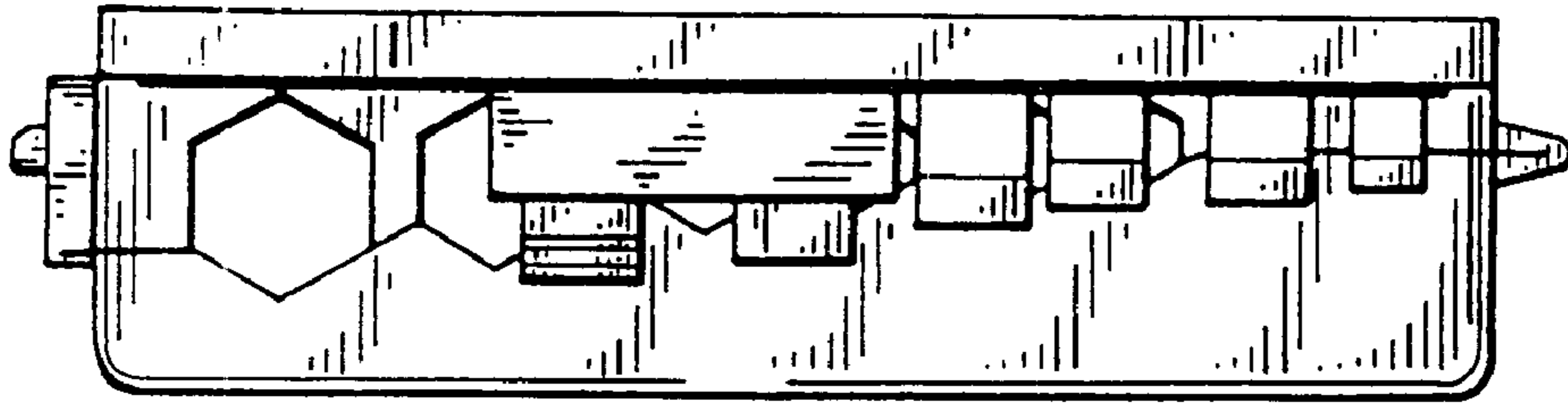

FIG. 4

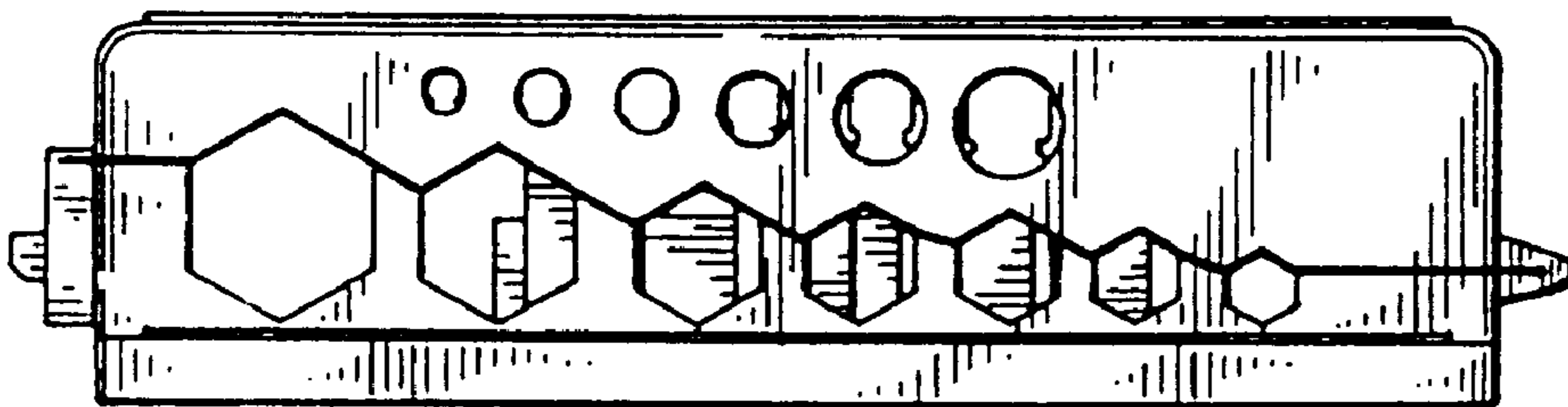

FIG. 5

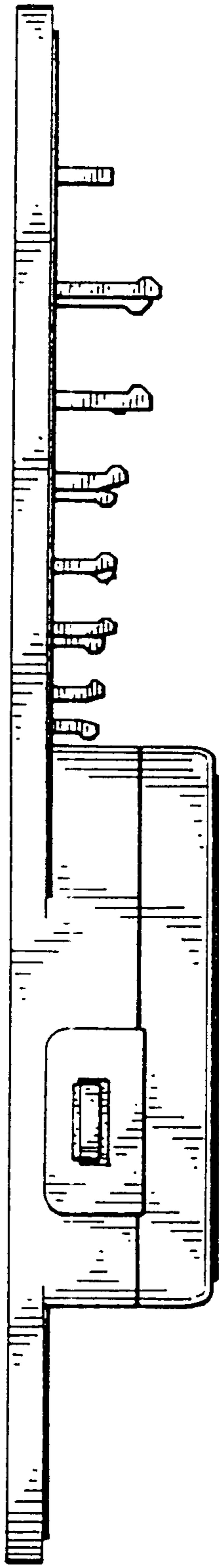

FIG. 6

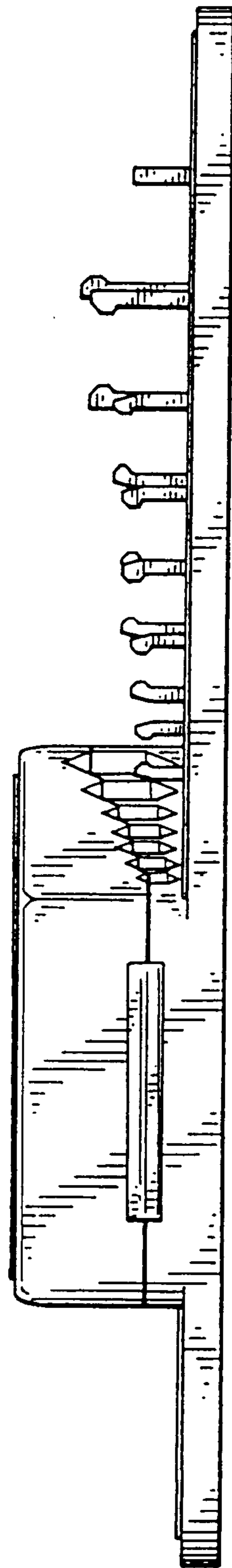

FIG. 7

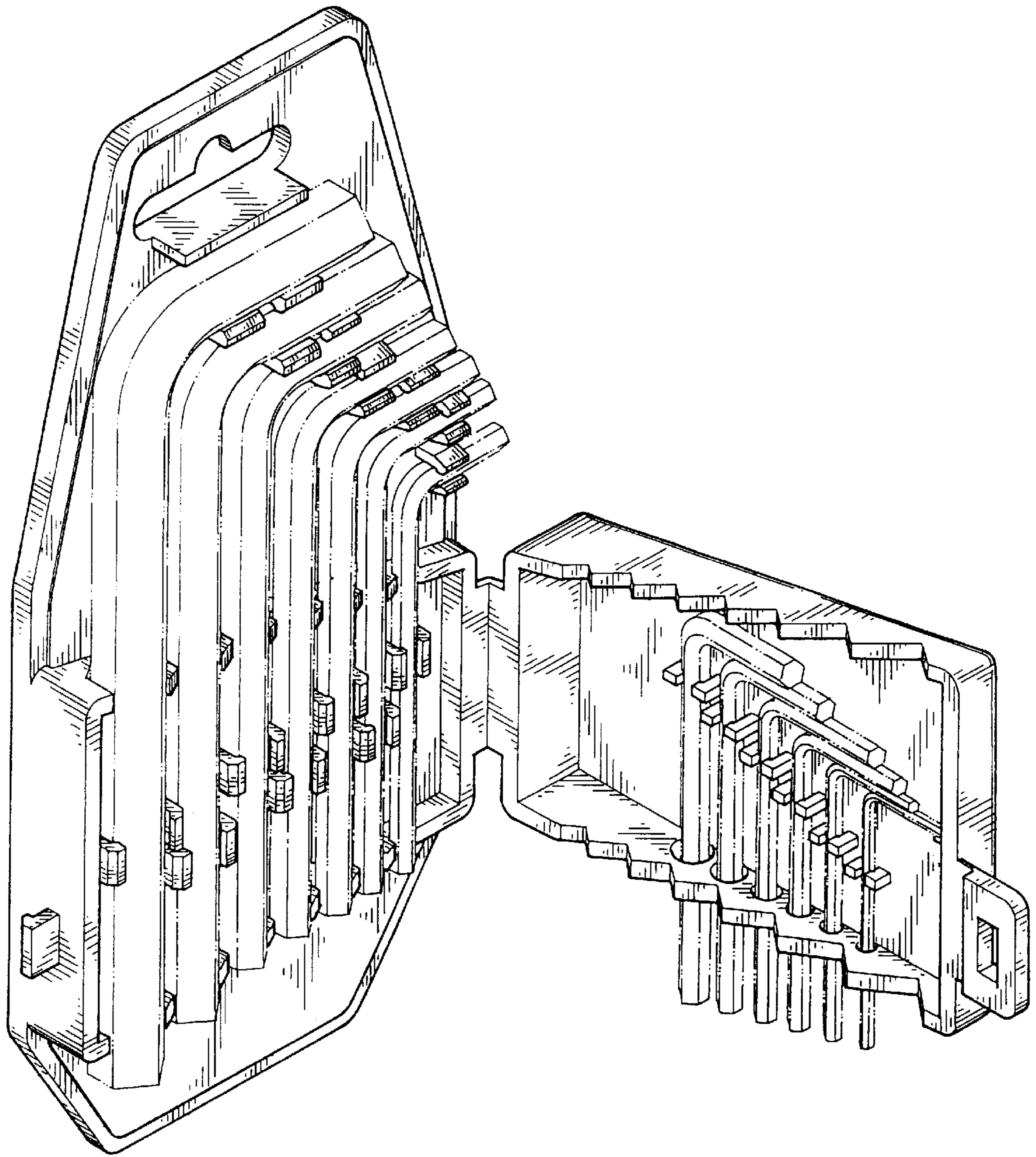

FIG. 8