



US00D418294S

United States Patent [19] Tanji

[11] **Patent Number: Des. 418,294**
[45] **Date of Patent: ** Jan. 4, 2000**

[54] **BOX**
[75] Inventor: **Hiroyuki Tanji**, Miyagi, Japan
[73] Assignee: **Iris Ohyama, Inc.**, Sendai, Japan
[**] Term: **14 Years**
[21] Appl. No.: **29/090,252**
[22] Filed: **Jul. 2, 1998**

D. 394,955 6/1998 Dickinson et al. D3/281
D. 401,409 12/1998 Yemini D3/281
D. 402,111 12/1998 Dickinson et al. D3/281
4,775,199 10/1988 Lanius et al. 312/220
5,193,706 3/1993 Hanna et al. 220/324

FOREIGN PATENT DOCUMENTS

920374 2/1995 Japan .
946500 2/1996 Japan .

Primary Examiner—Philip S. Hyder
Attorney, Agent, or Firm—Foley & Lardner

Related U.S. Application Data

[62] Division of application No. 29/078,548, Oct. 30, 1997.

Foreign Application Priority Data

May 16, 1997 [JP] Japan 9-54613
May 16, 1997 [JP] Japan 9-54614

[51] **LOC (7) Cl.** **03-01**

[52] **U.S. Cl.** **D3/276; D3/291; D3/294; D3/905**

[58] **Field of Search** D3/273, 276, 281, D3/282, 283, 284, 294, 291, 905; 206/349, 315.11, 372, 373; 190/114

References Cited

U.S. PATENT DOCUMENTS

D. 228,580 10/1973 Schurman D3/281
D. 312,173 11/1990 Smith et al. D3/291
D. 314,666 2/1991 Lanius D3/281
D. 315,247 3/1991 Lovell D3/281
D. 315,445 3/1991 Lanius D3/281
D. 321,433 11/1991 Dickinson D3/905
D. 328,818 8/1992 Hanna et al. D3/281
D. 328,819 8/1992 Hanna et al. D3/281
D. 337,198 7/1993 Chauvin D3/291
D. 341,294 11/1993 Doxey D3/291
D. 361,659 8/1995 Kahl et al. D3/905
D. 361,888 9/1995 Kahl et al. D3/905
D. 378,874 4/1997 Dickinson et al. D3/294
D. 385,110 10/1997 Yemini D3/282

[57] CLAIM

The ornamental design for a box, as shown and described.

DESCRIPTION

FIG. 1 is a top plain view of a first embodiment of a box showing my new design;
FIG. 2 is a front elevational view thereof;
FIG. 3 is a rear elevational view thereof;
FIG. 4 is a left side elevational view thereof;
FIG. 5 is a first right side elevational view thereof;
FIG. 6 is a second right side elevational view thereof, wherein the handle portion is in the upright position; and,
FIG. 7 is a third right side elevational view thereof, wherein the latch is in the off position, the cover is in the open position and the front lid portion is in the open position.
FIG. 8 top plain view of a second embodiment of a box showing my new design;
FIG. 9 is a front elevational view thereof;
FIG. 10 is a rear elevational view thereof;
FIG. 11 is a left side elevational view thereof;
FIG. 12 is a first right side elevational view thereof;
FIG. 13 is a second right side elevational view thereof, wherein the handle portion is in the upright position; and,
FIG. 14 is a third right side elevational view thereof, wherein the latch is in the off position, the cover is in the open position and the front lid portion is in the open position.

1 Claim, 8 Drawing Sheets

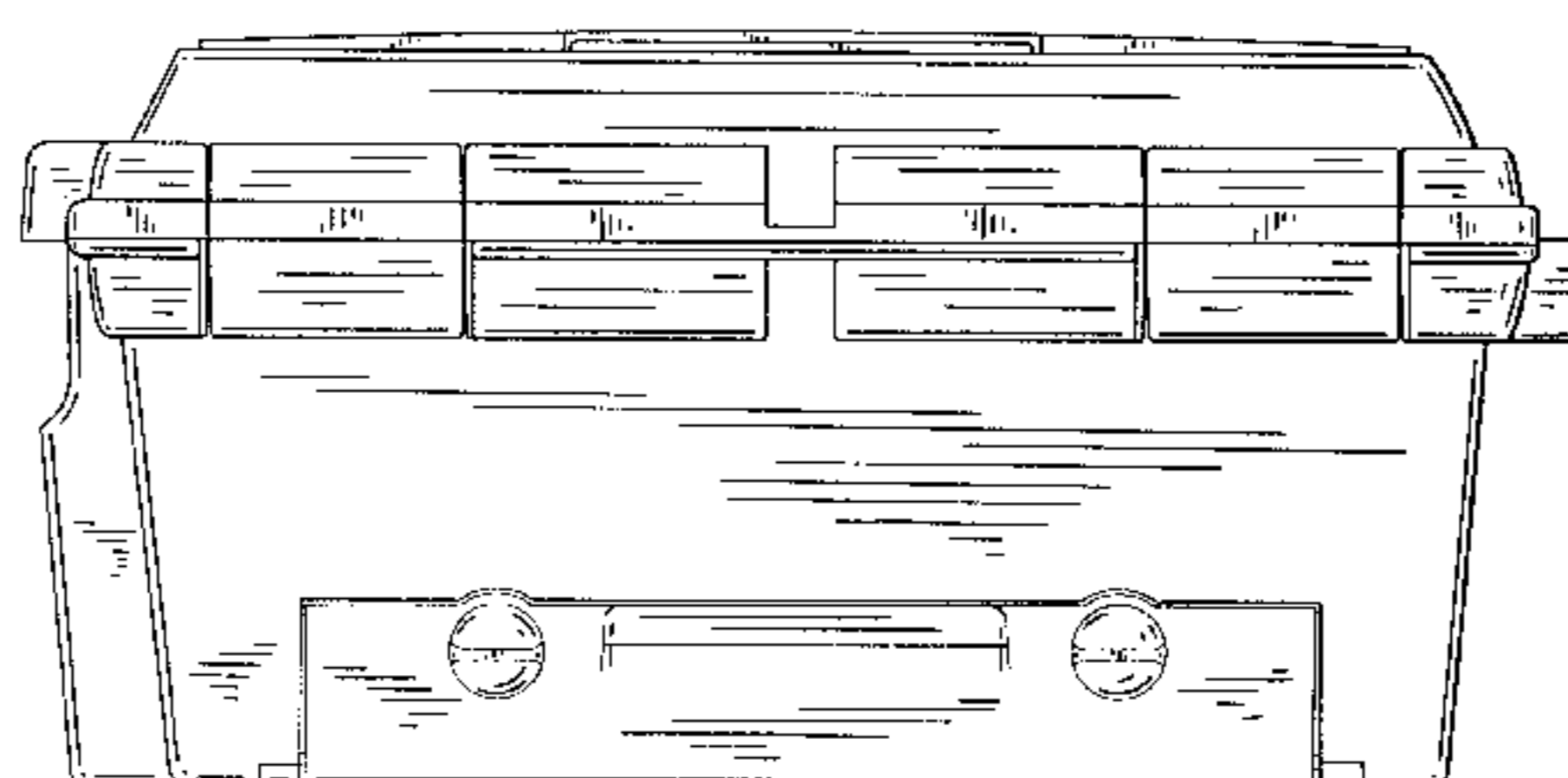
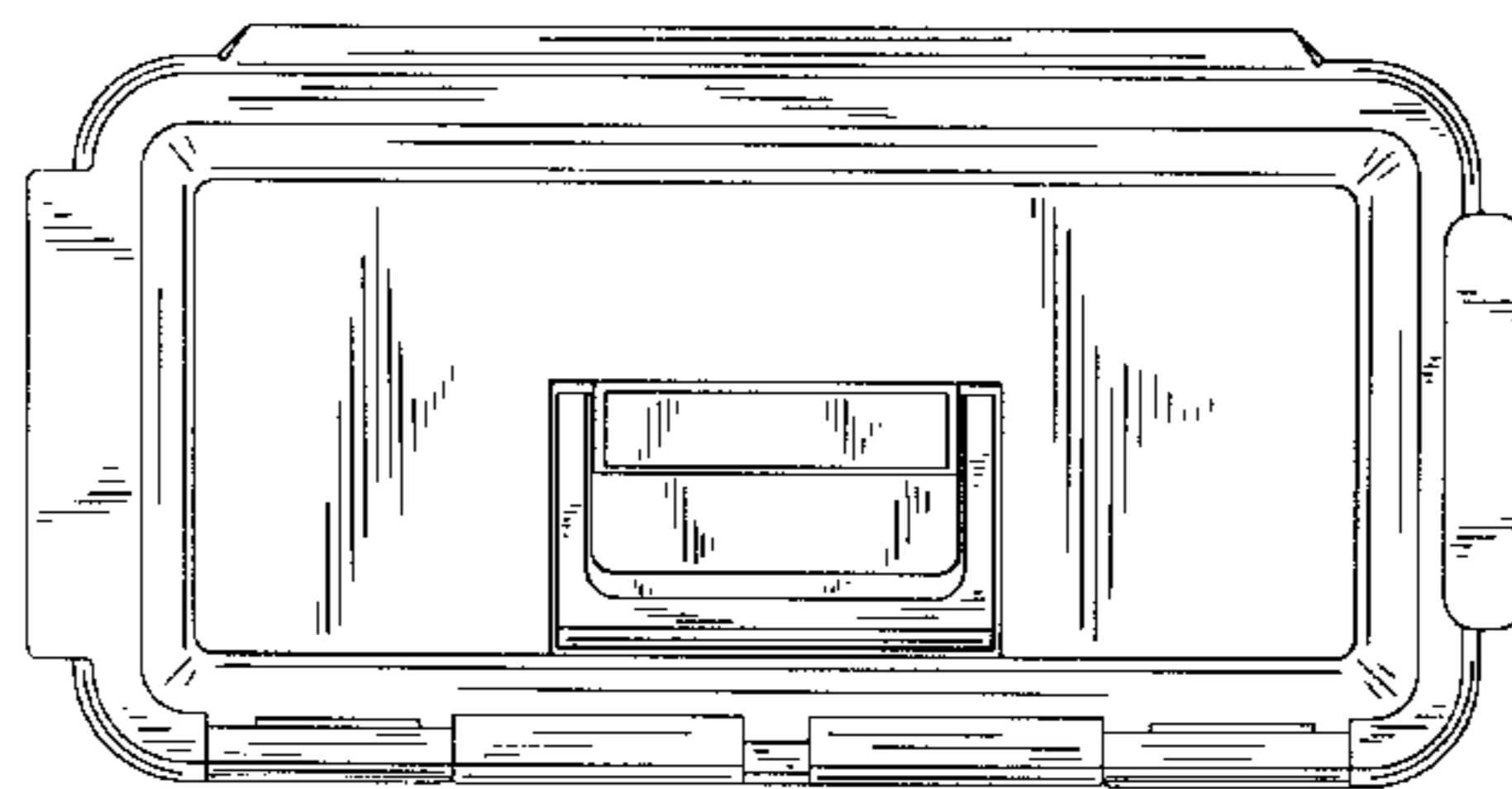

FIG. 1

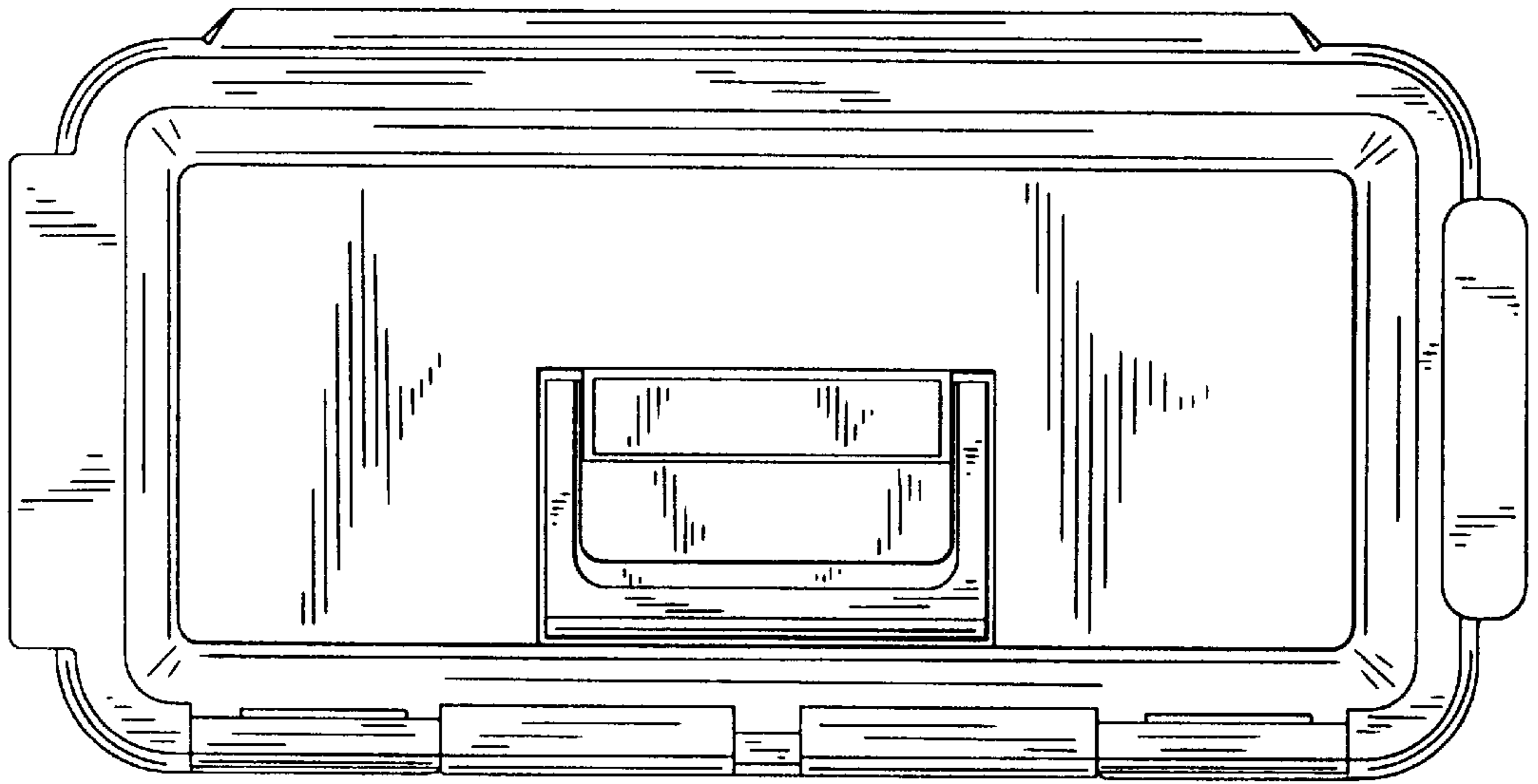

FIG. 2

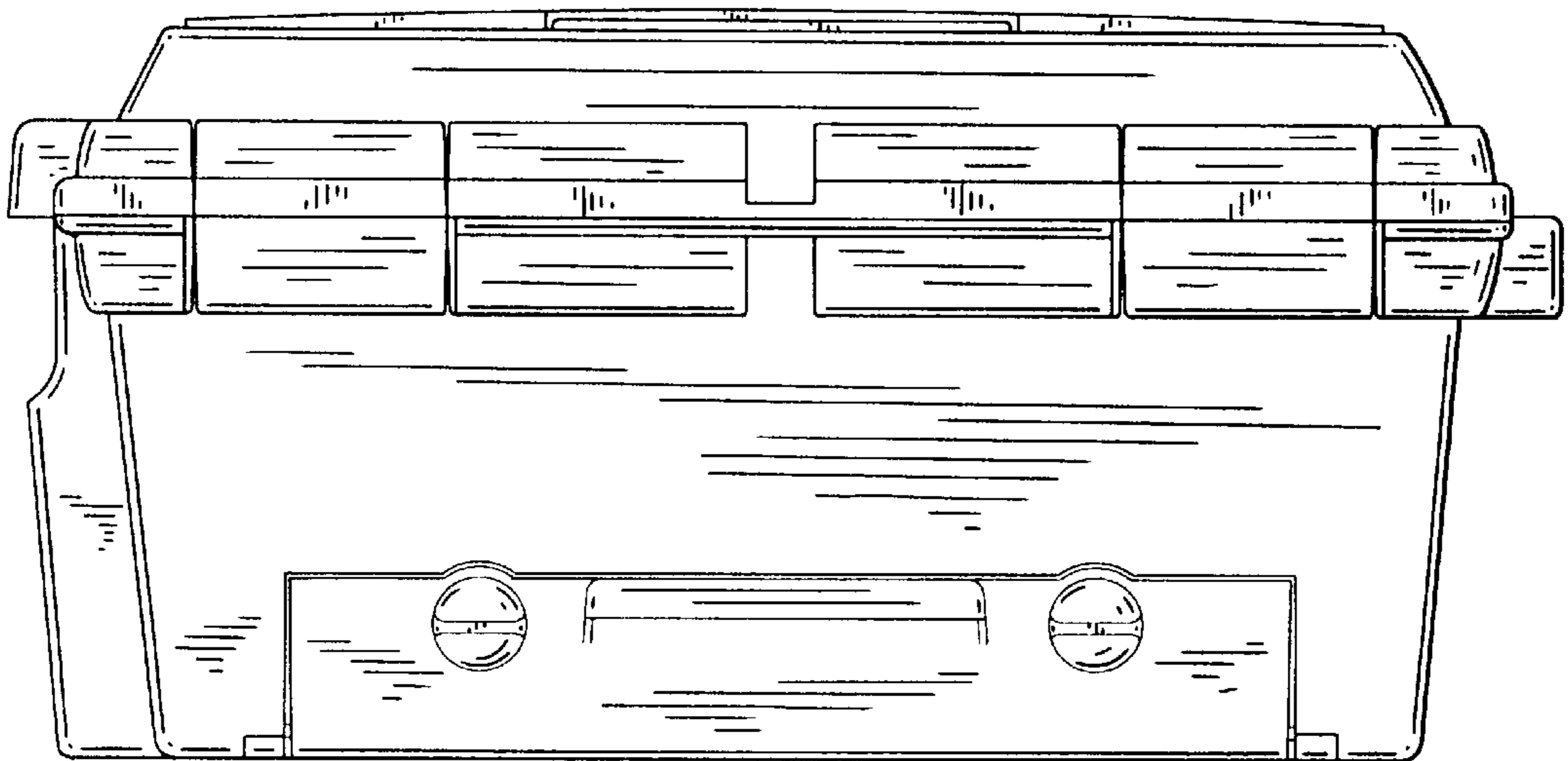

FIG. 3

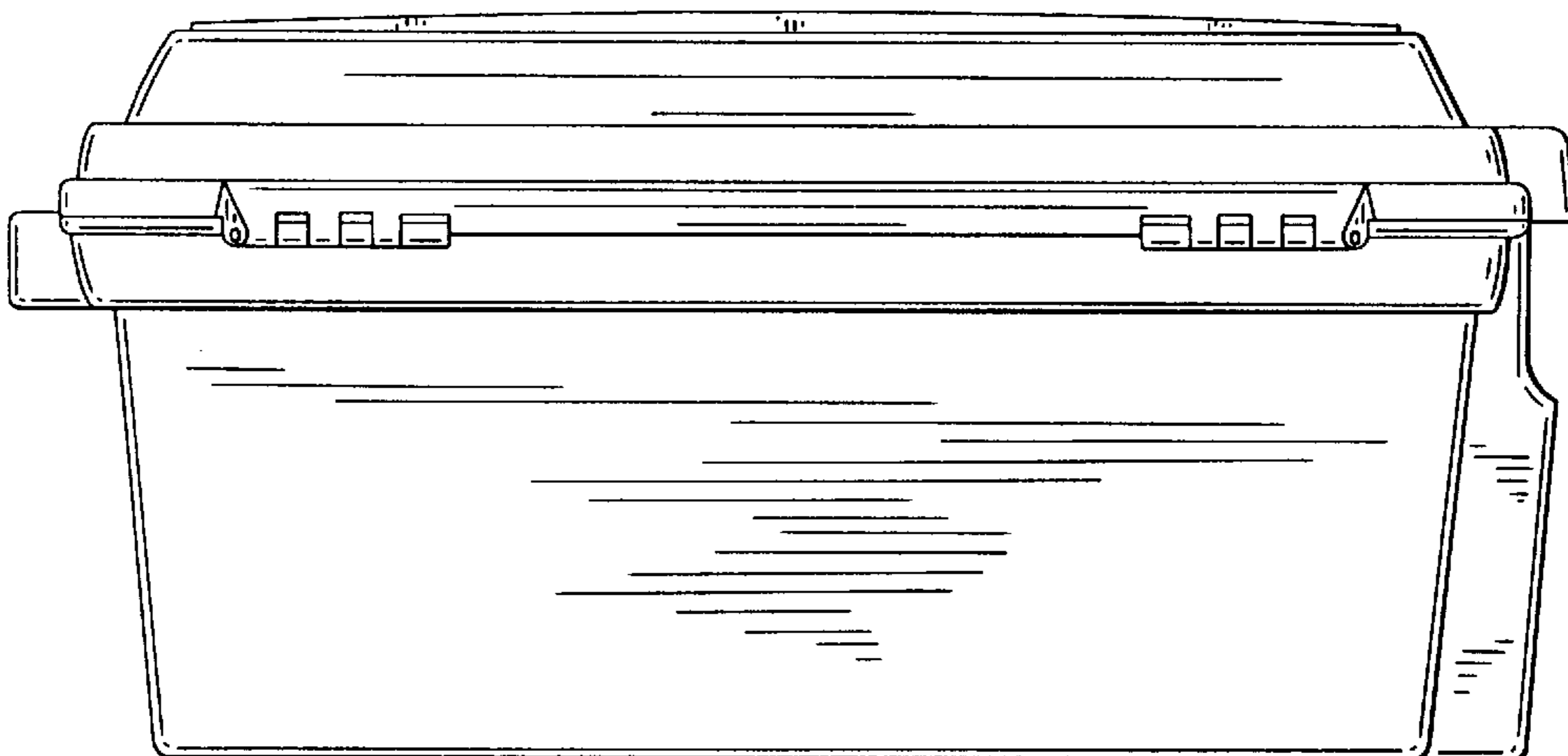

FIG.4

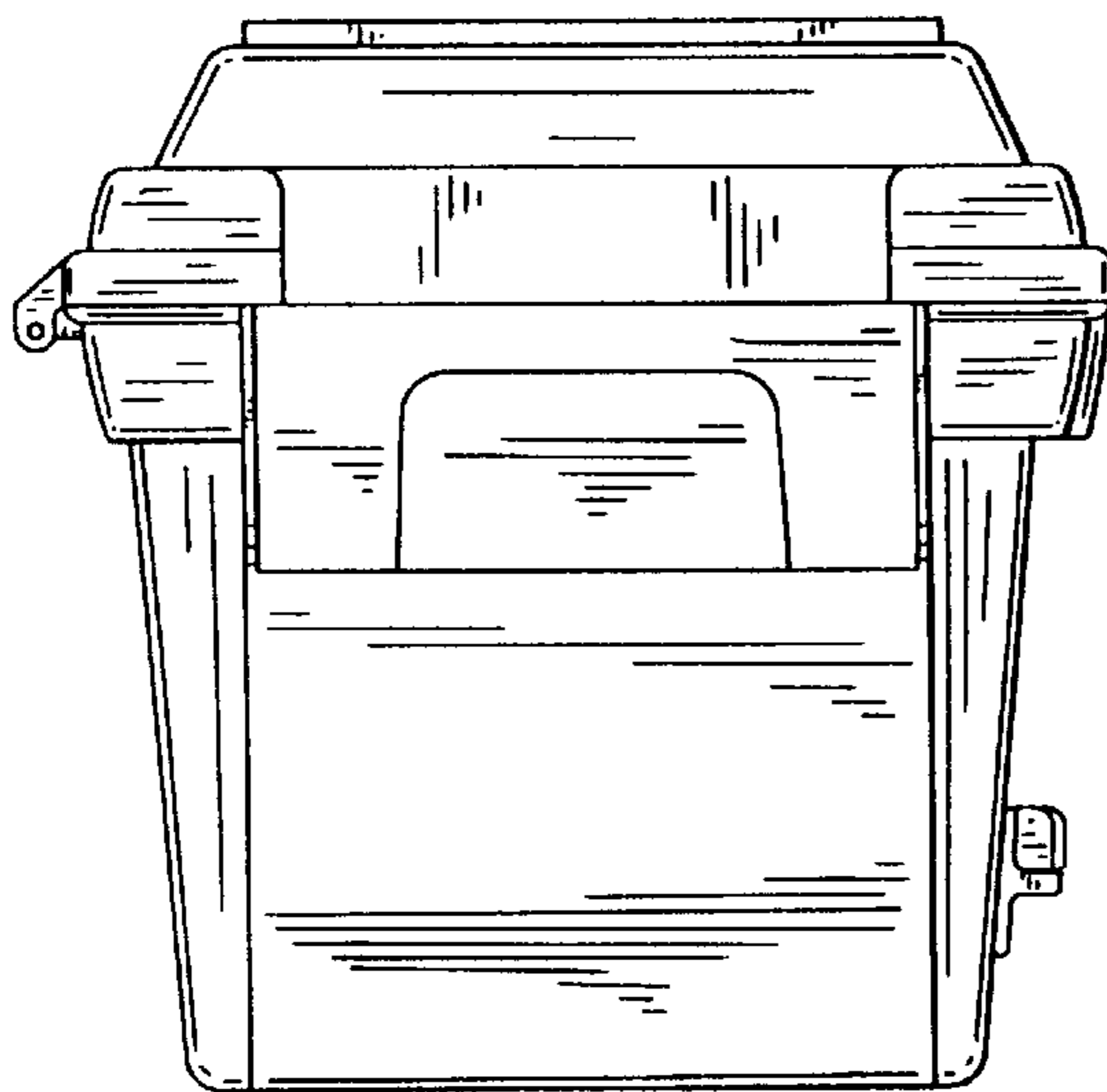

FIG.5

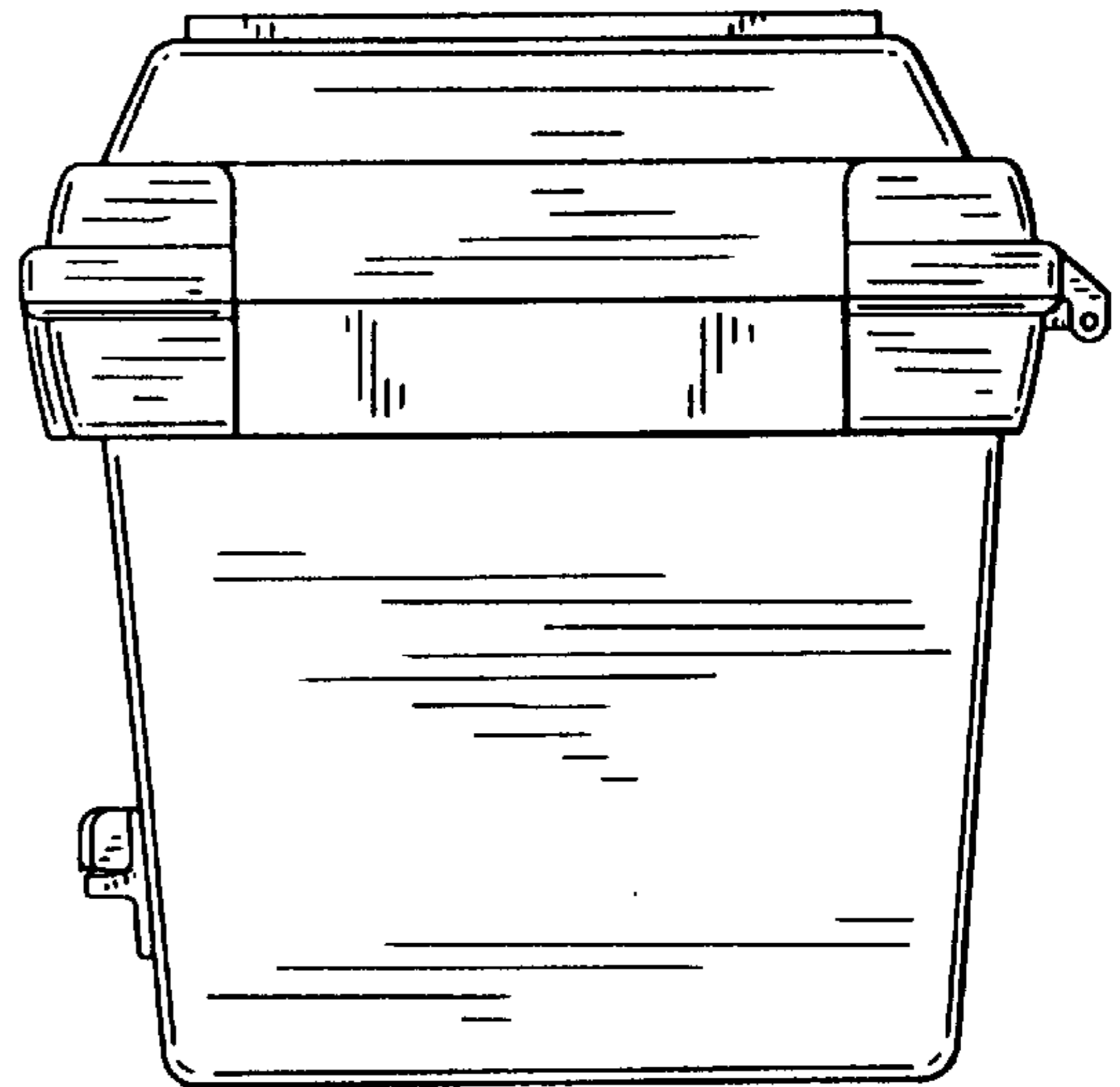

FIG. 6

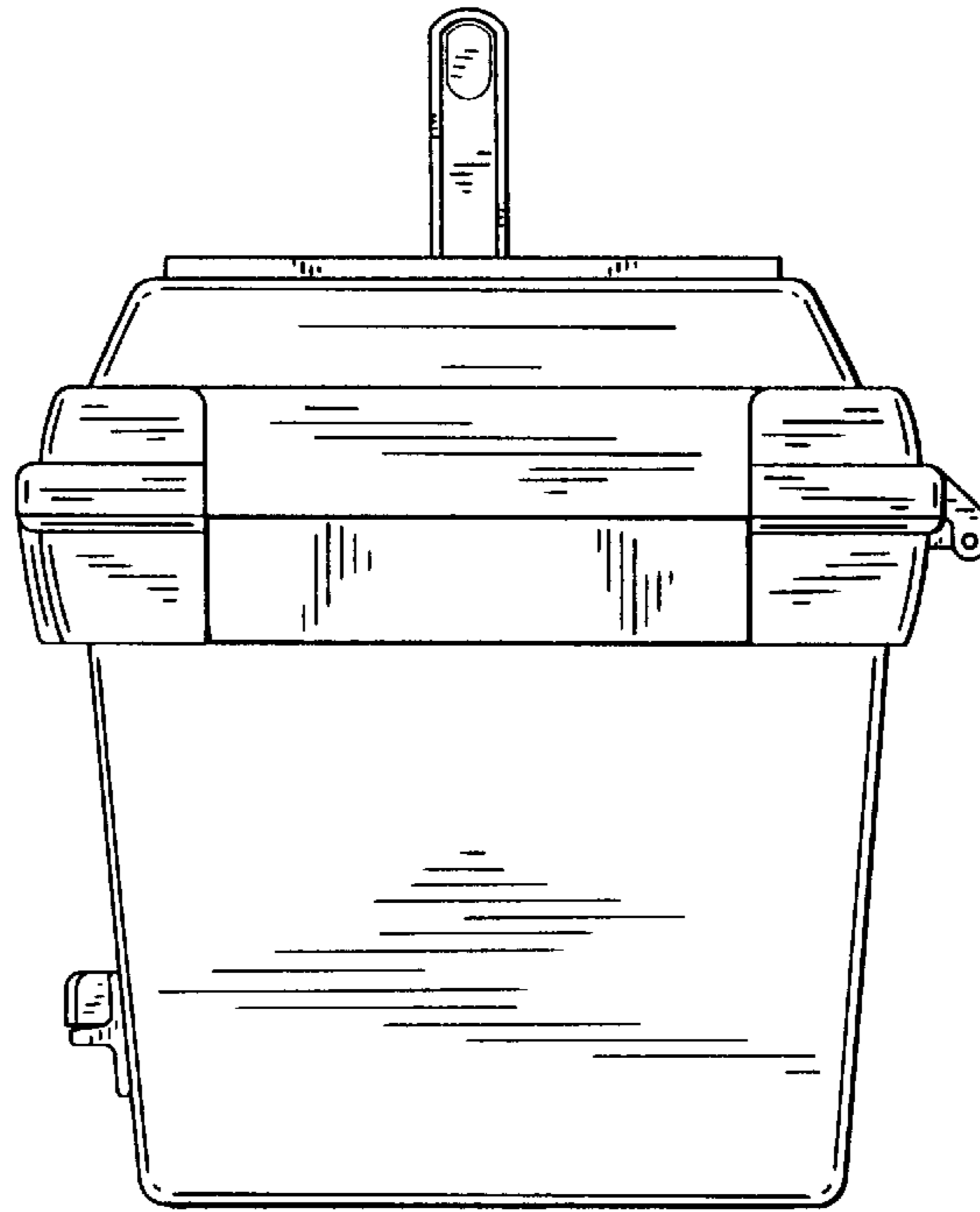

FIG. 7

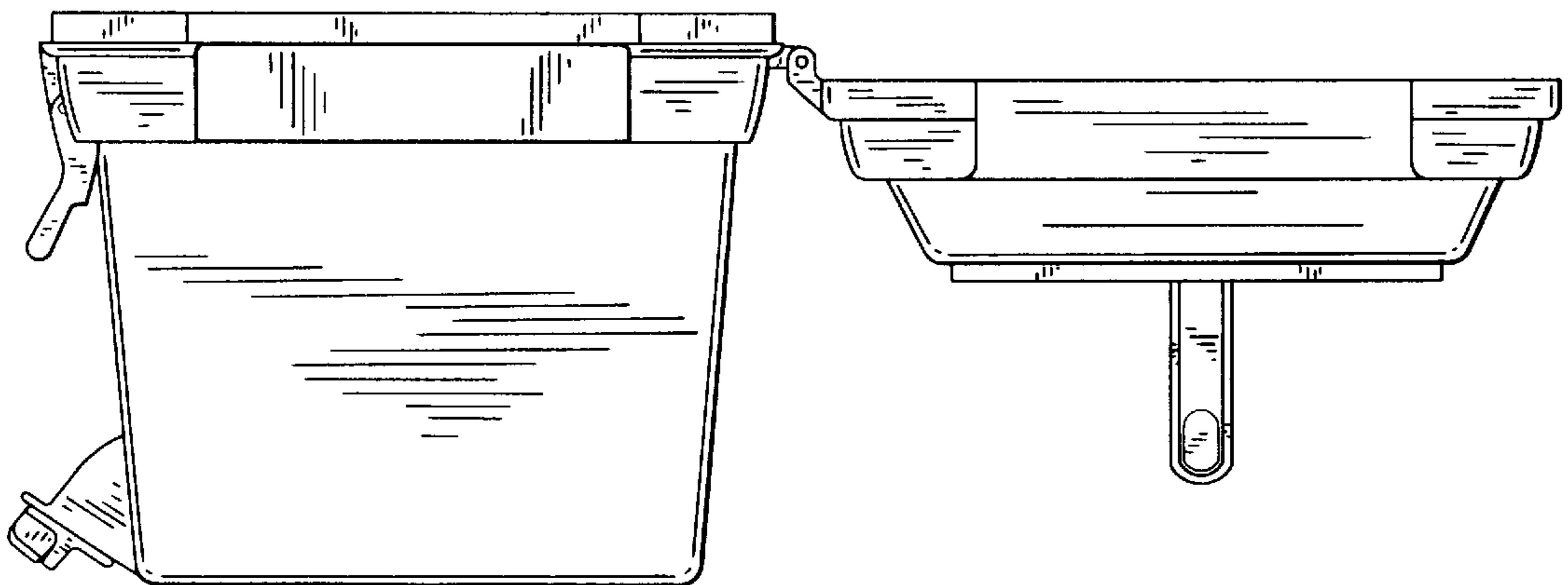

FIG. 8

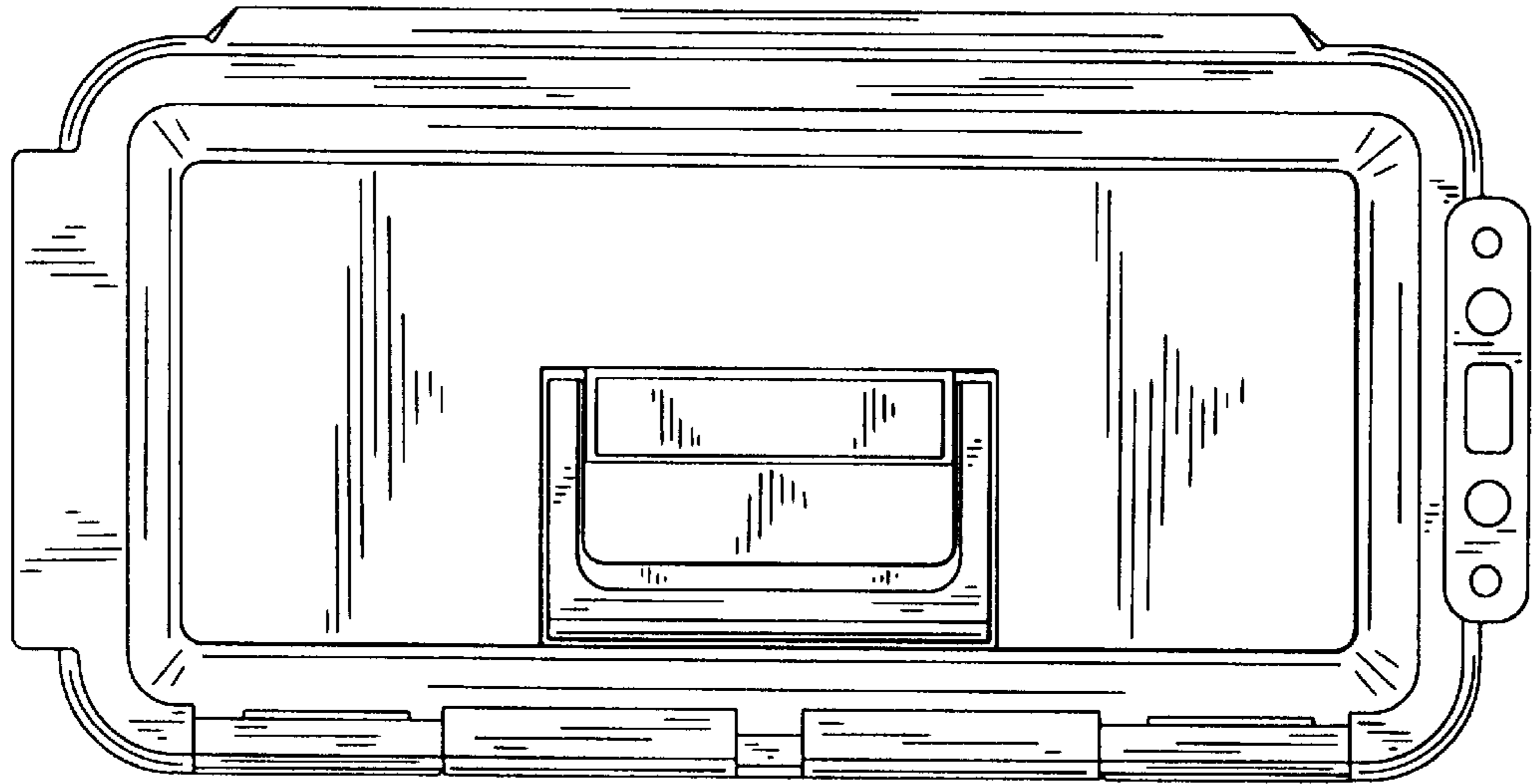

FIG. 9

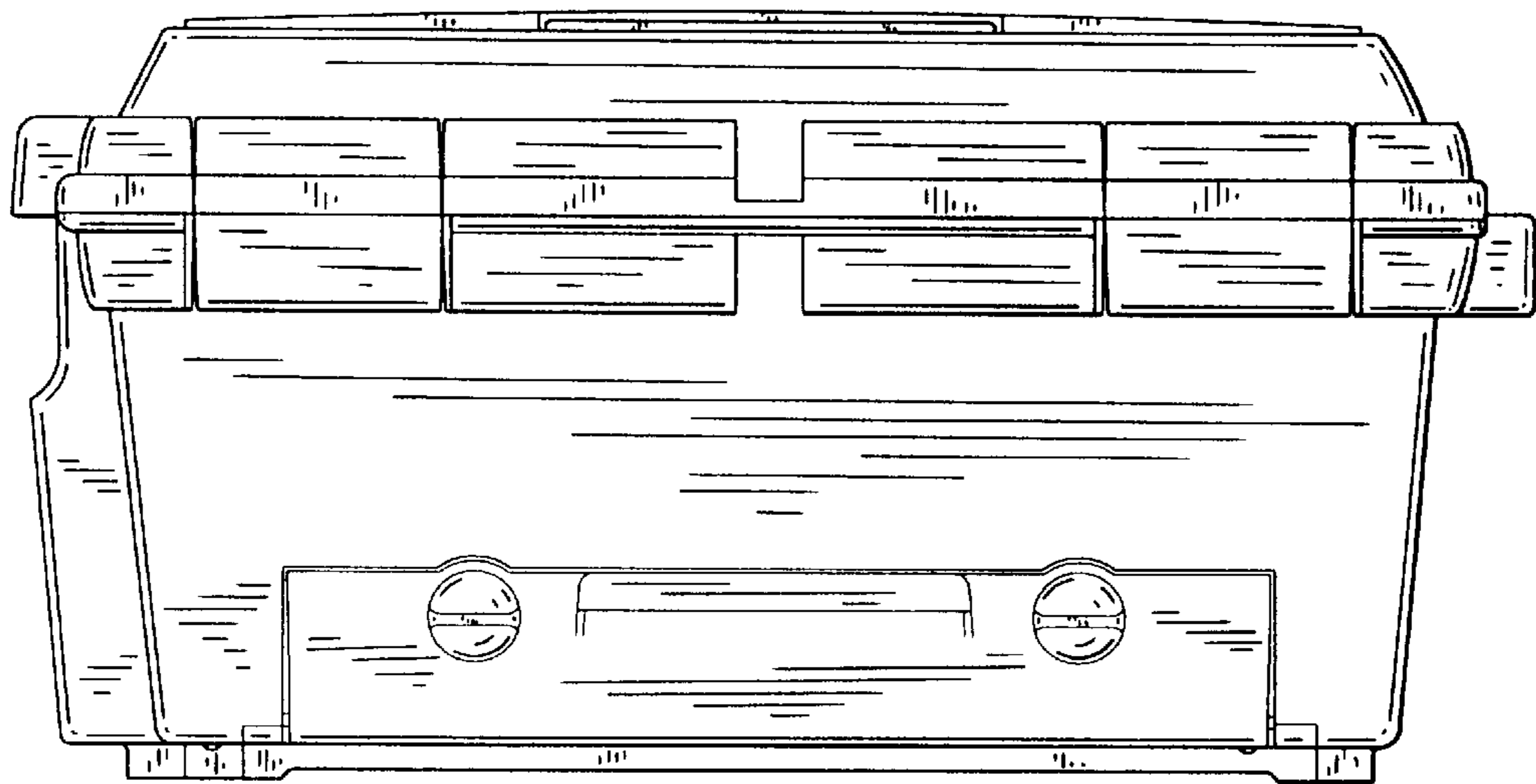

FIG. 10

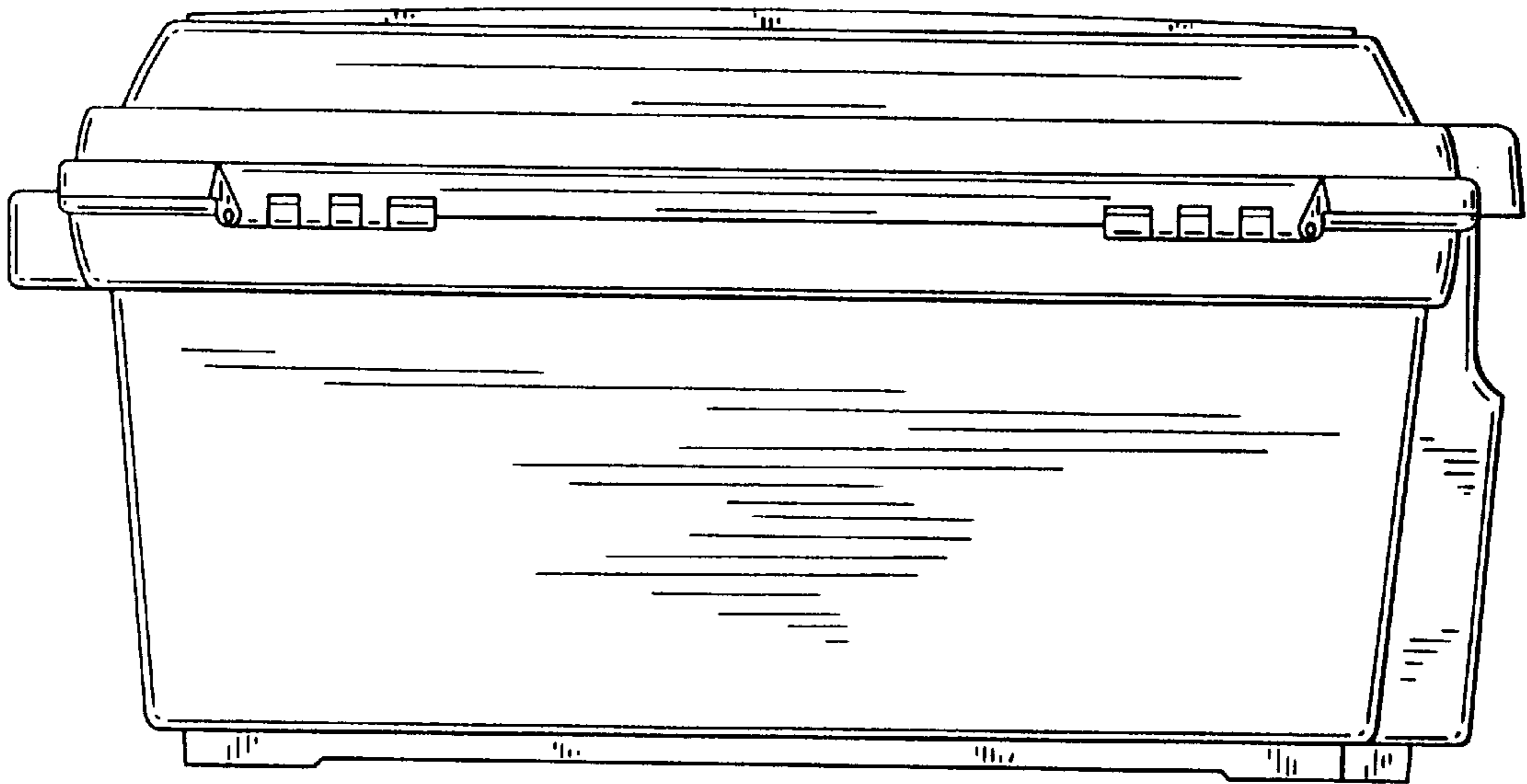

FIG. 11

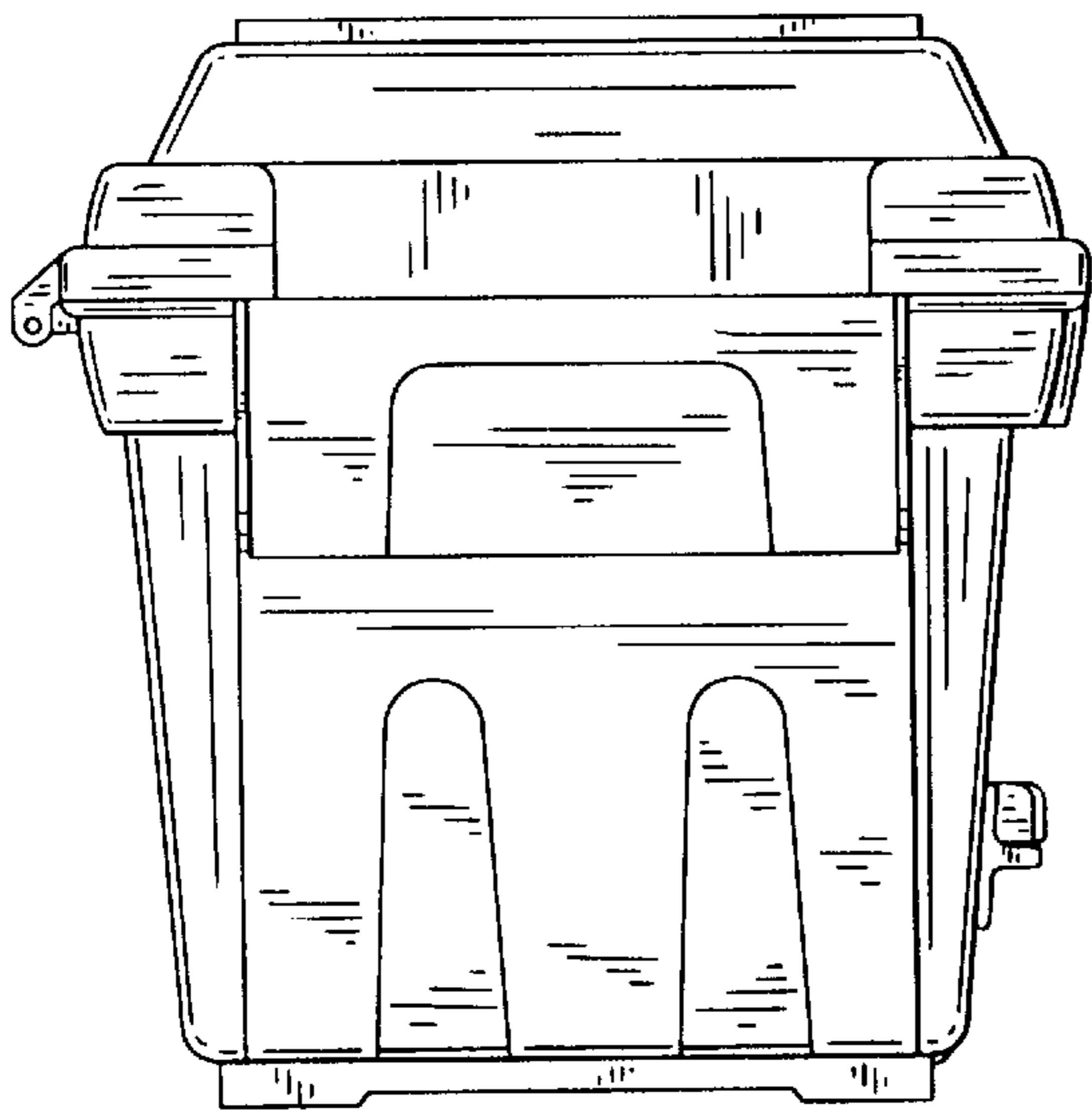

FIG. 12

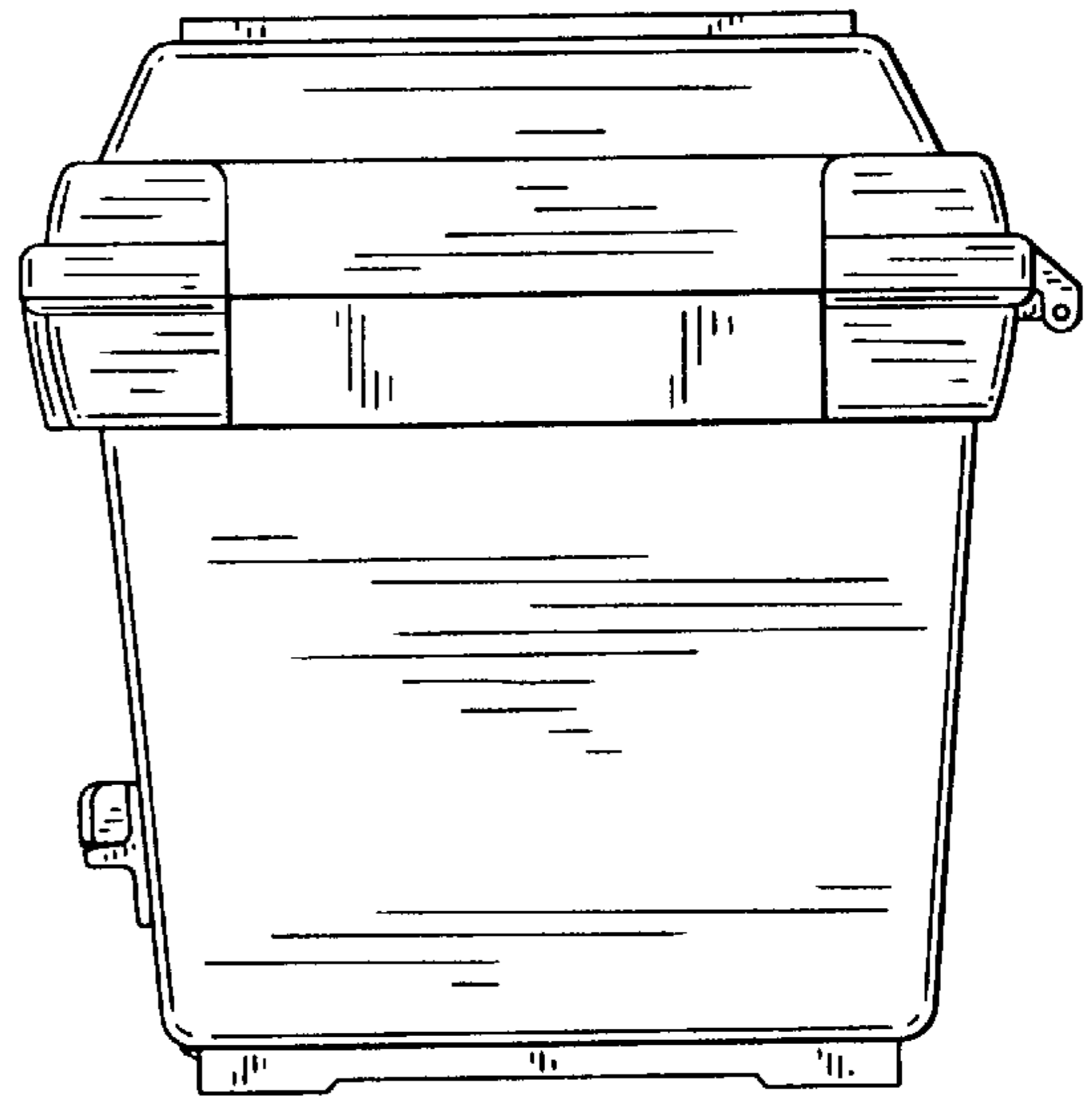

FIG. 13

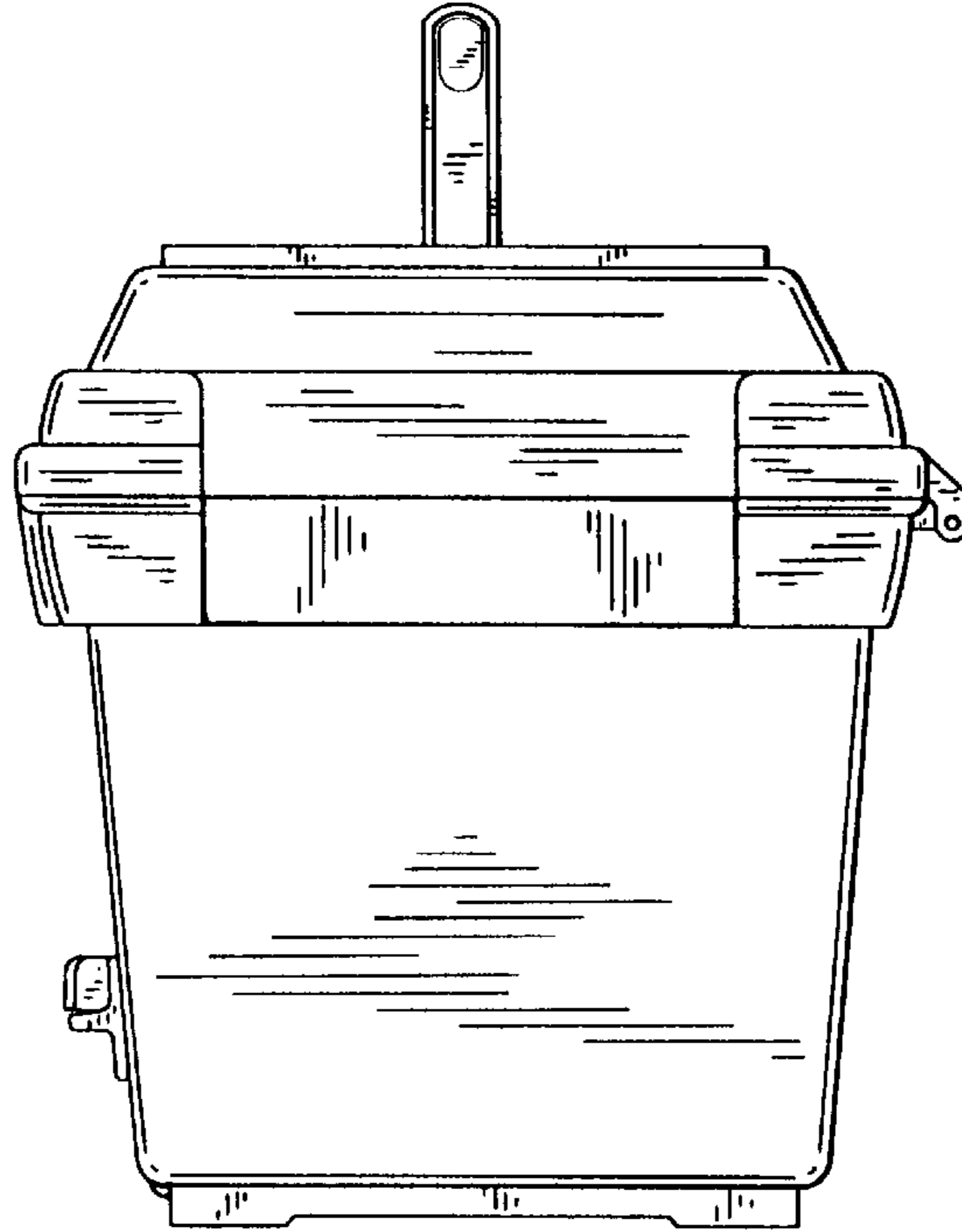

FIG. 14

