



US00D418266S

# United States Patent [19]

Medema et al.

[11] Patent Number: Des. 418,266

[45] Date of Patent: \*\* Dec. 28, 1999

[54] UPRIGHT VACUUM CLEANER

5,347,679 9/1994 Saunders et al. .... 15/416

[75] Inventors: Douglas J. Medema, Belding; Jose Carlito Santiago, Grand Rapids, both of Mich.

### OTHER PUBLICATIONS

Author unknown, Shetland Floor and Rug Care Appliances catalog page, effective May 1, 1962, page number unknown.

[73] Assignee: Bissell Homecare, Inc., Grand Rapids, Mich.

Primary Examiner—Ruth McInroy  
Attorney, Agent, or Firm—Rader, Fishman, Grauer & McGarry

[\*\*] Term: 14 Years

[21] Appl. No.: 29/093,982

### [57] CLAIM

We claim the design for an upright vacuum cleaner, as shown and described.

[22] Filed: Sep. 23, 1998

### DESCRIPTION

[51] LOC (6) Cl. .... 15-05

[52] U.S. Cl. .... D32/22

[58] Field of Search ..... D32/21, 22, 50,  
D32/51; D4/100; 15/350, 344, 329, 320-321,  
144.4, 398, 410, 246, 400

FIG. 1 is a front perspective view of an upright vacuum cleaner showing our new design;  
FIG. 2 is a front view thereof;  
FIG. 3 is a rear view thereof;  
FIG. 4 is a right side view thereof;  
FIG. 5 is a left side view thereof;  
FIG. 6 is a top view thereof;  
FIG. 7 is a bottom view thereon;  
FIG. 8 is a front perspective view of a second embodiment thereof;  
FIG. 9 is a front view thereof;  
FIG. 10 is a rear view thereof;  
FIG. 11 is a right side view thereof;  
FIG. 12 is a left side view thereof;  
FIG. 13 is a top view thereof; and,  
FIG. 14 is a bottom view thereof.

### [56] References Cited

#### U.S. PATENT DOCUMENTS

- D. 155,903 11/1949 Kelly .
- D. 189,124 11/1960 Keinhofer .
- D. 299,175 12/1988 Nimon et al. .... D32/22
- D. 303,171 8/1989 Goodrich et al. .
- D. 307,656 5/1990 Yuen .
- D. 328,165 7/1992 Ferrari et al. .... D32/22
- D. 344,821 3/1994 McKnight .
- D. 359,604 6/1995 Sovis et al. .... D32/22
- D. 377,697 1/1997 Stephens et al. .
- D. 381,144 7/1997 Moine et al. .
- D. 382,681 8/1997 Thomas .
- D. 382,682 8/1997 Wareham et al. .
- D. 386,843 11/1997 Strohmeyer et al. .... D32/22
- D. 386,845 11/1997 Wareham et al. .
- D. 399,618 10/1998 Jacobs ..... D32/22

The hose shown in broken lines in FIGS. 1-7 is shown for illustrative purposes only and forms no part of the claimed design.

1 Claim, 8 Drawing Sheets

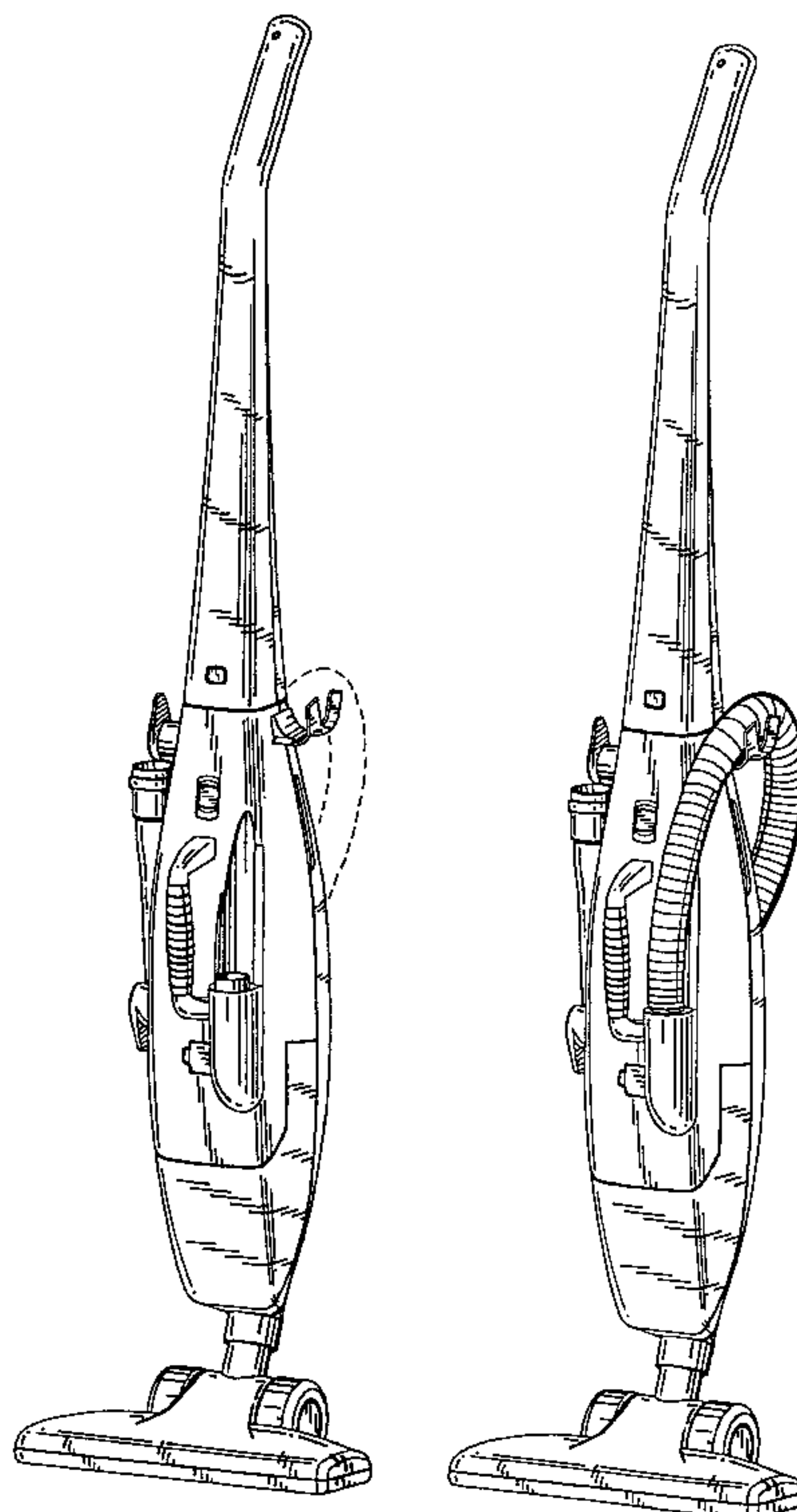

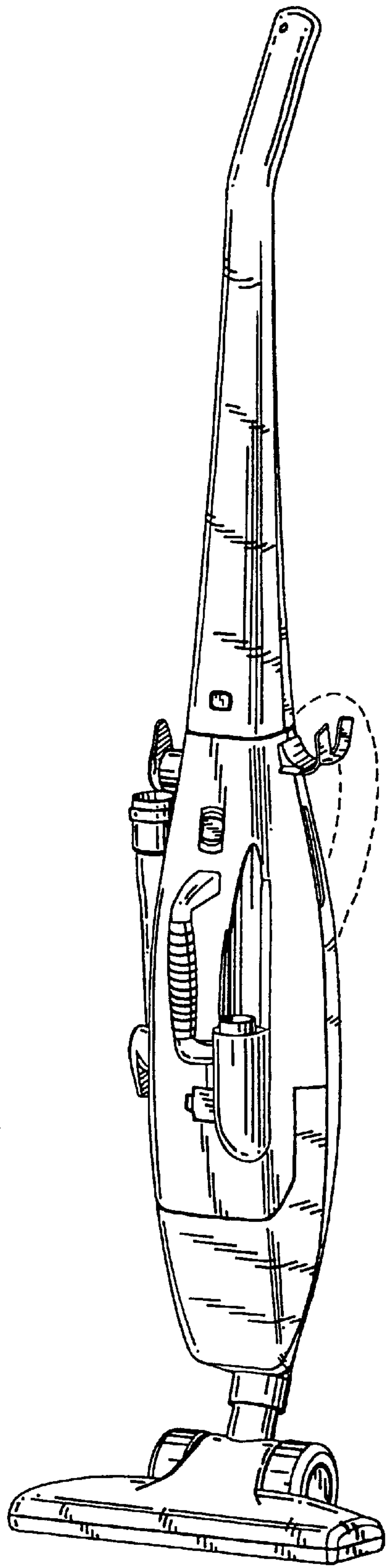

Fig. 1

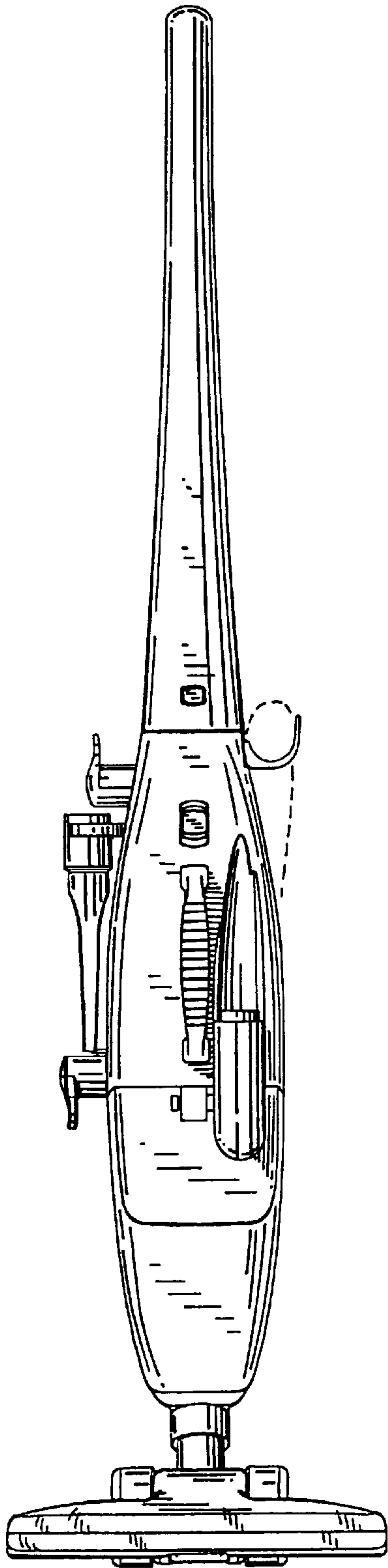

Fig. 2

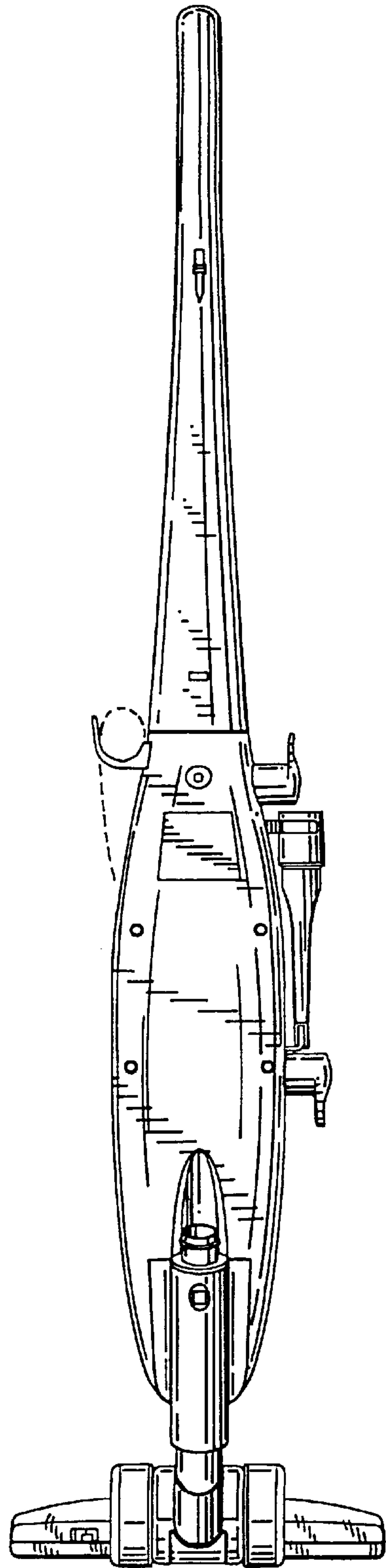

Fig. 3

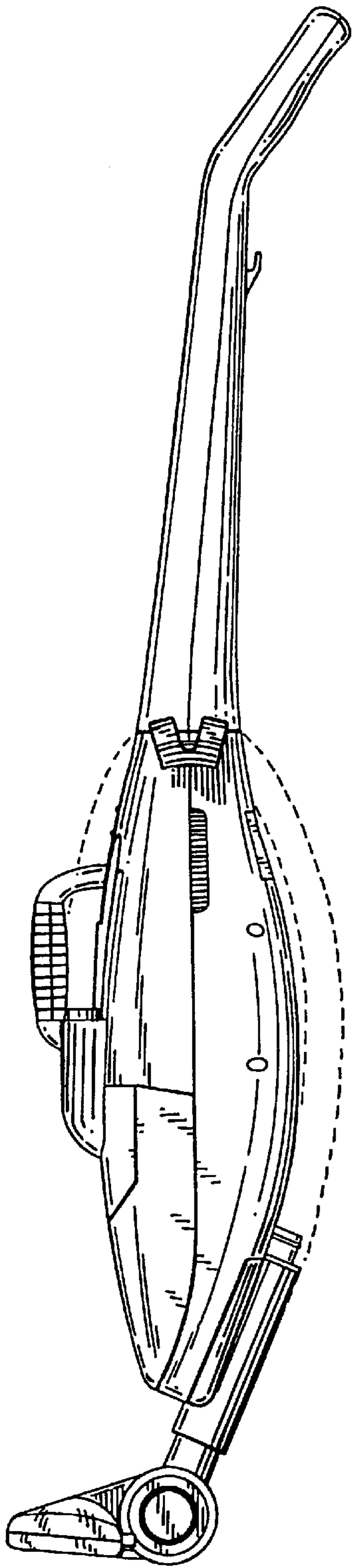

Fig. 4

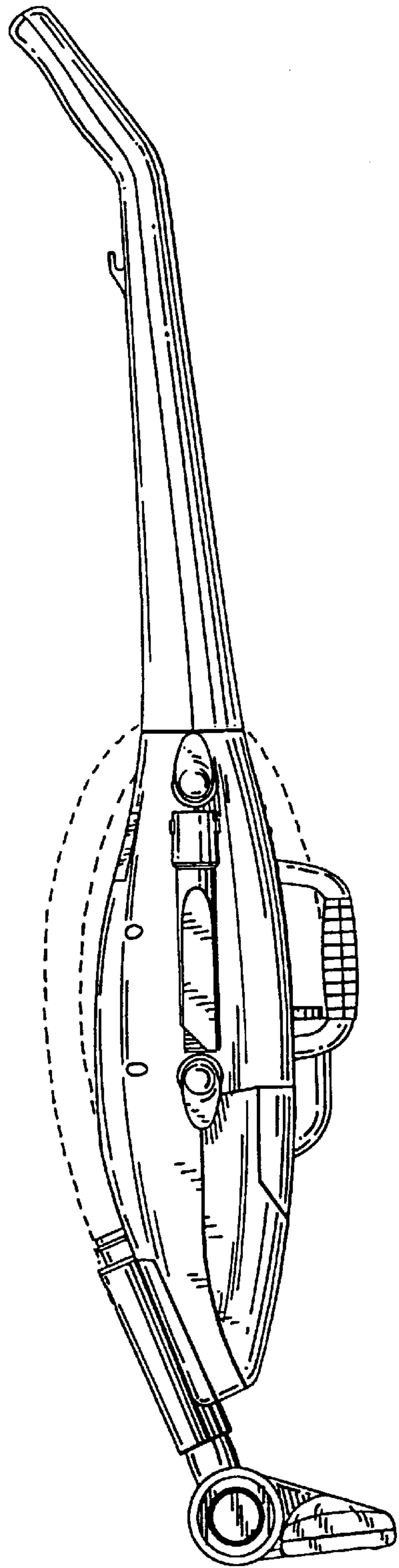

Fig. 5

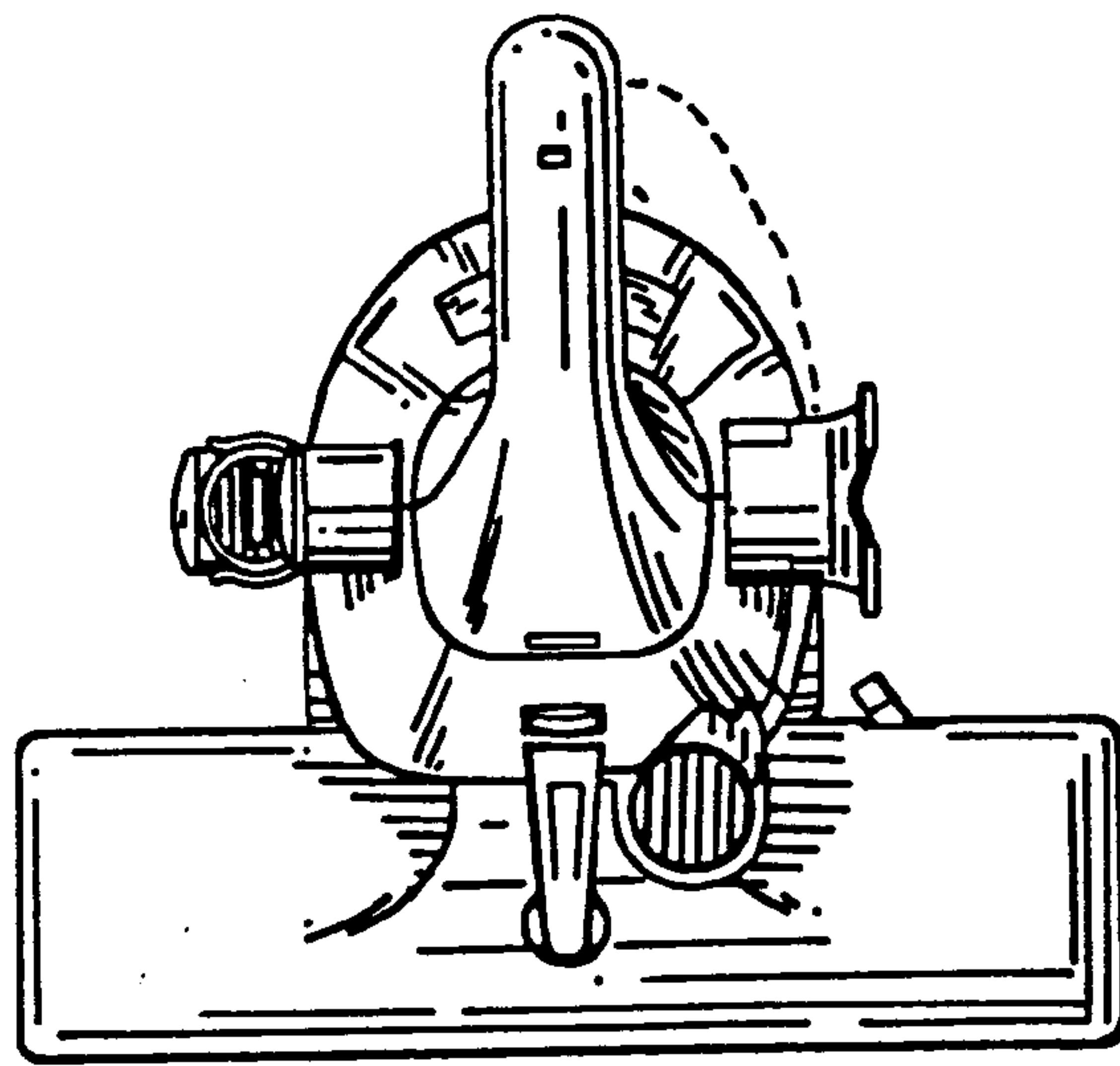

Fig. 6

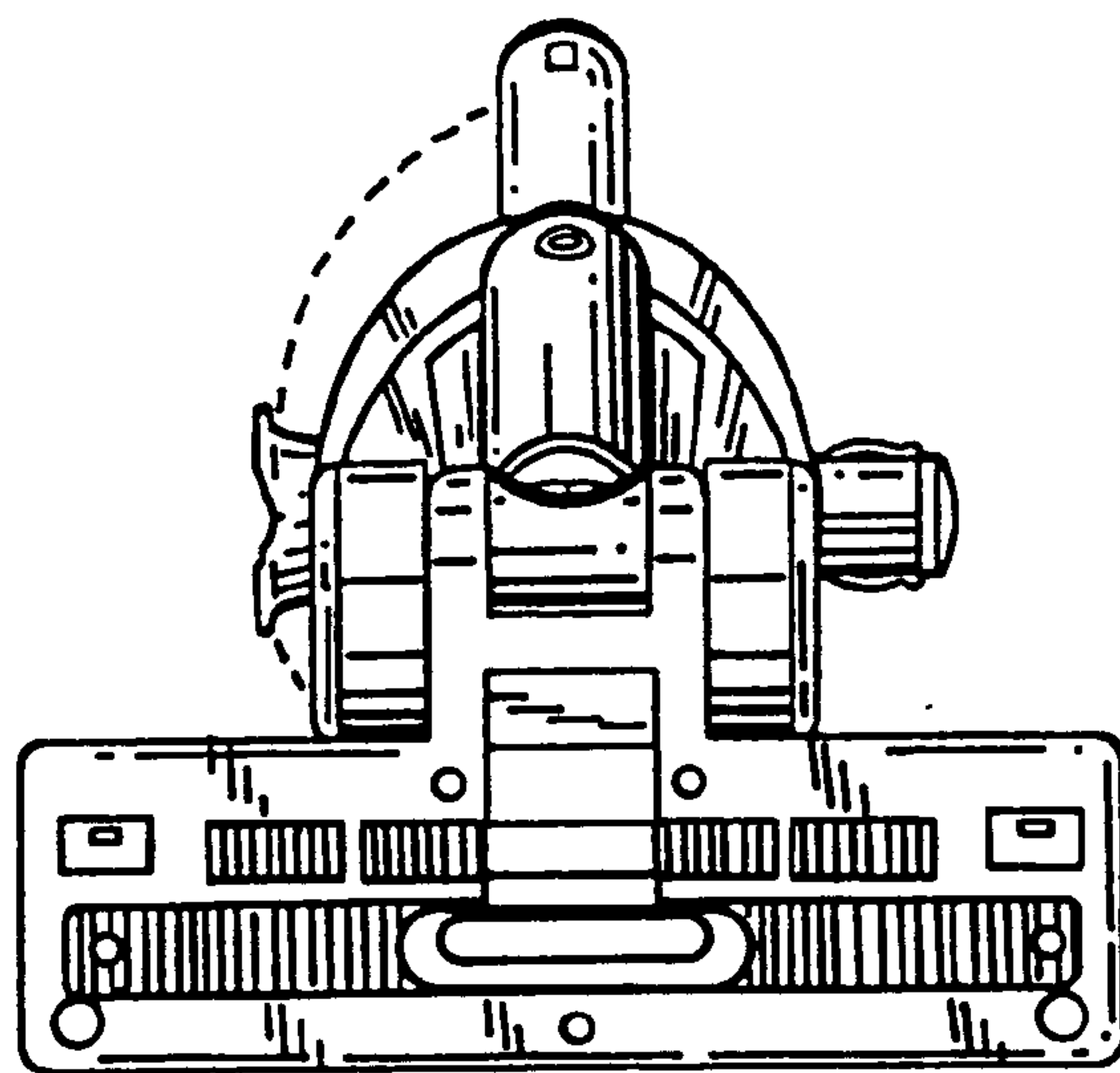

Fig. 7



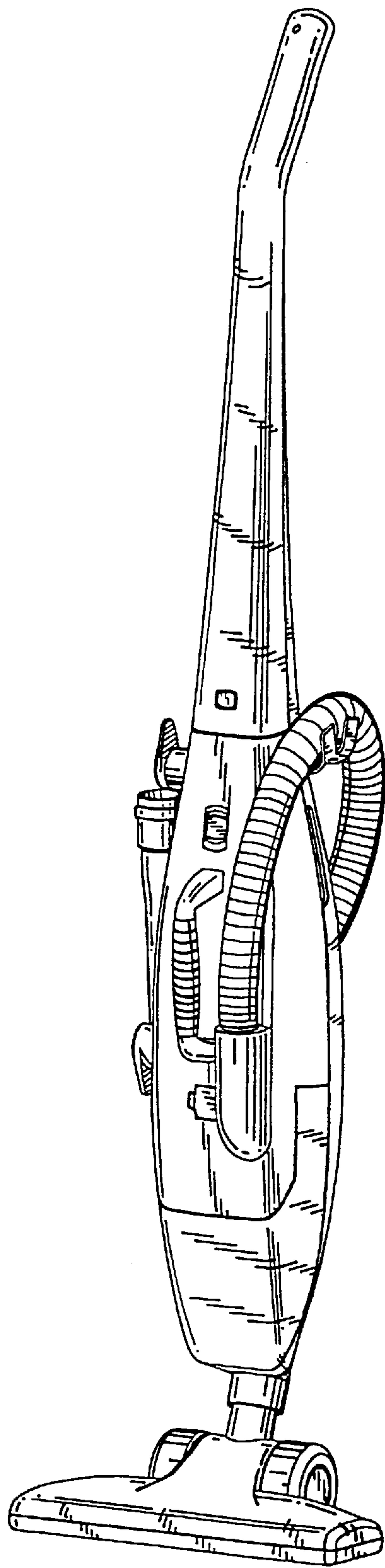

Fig. 8

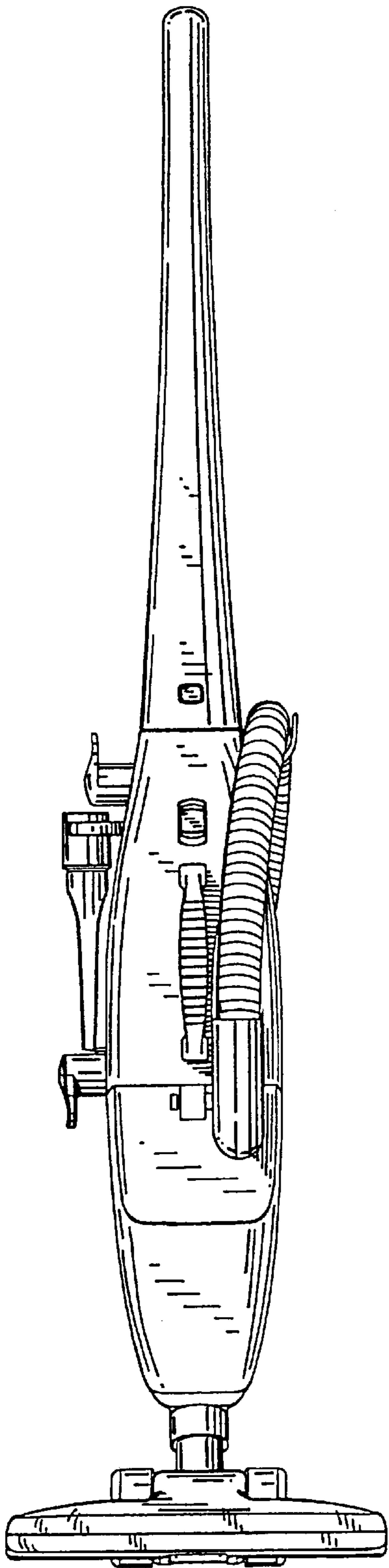

Fig. 9

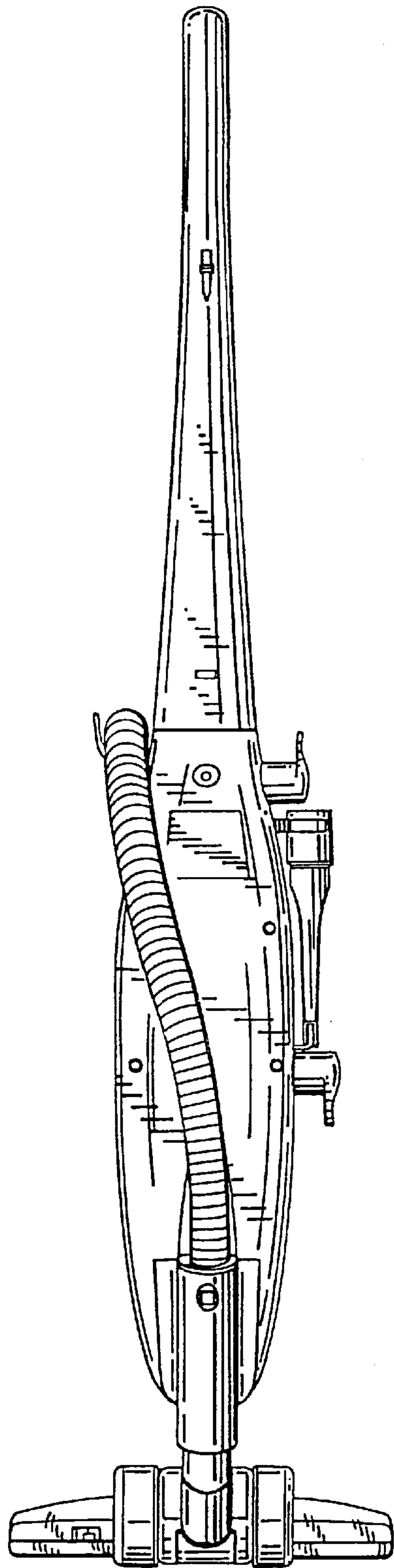

Fig. 10

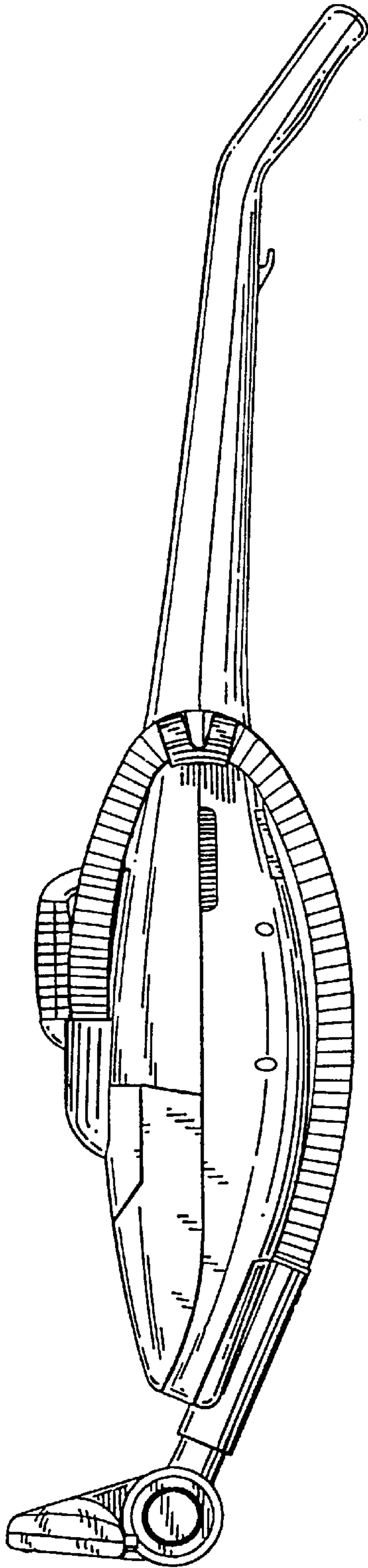

Fig. 11

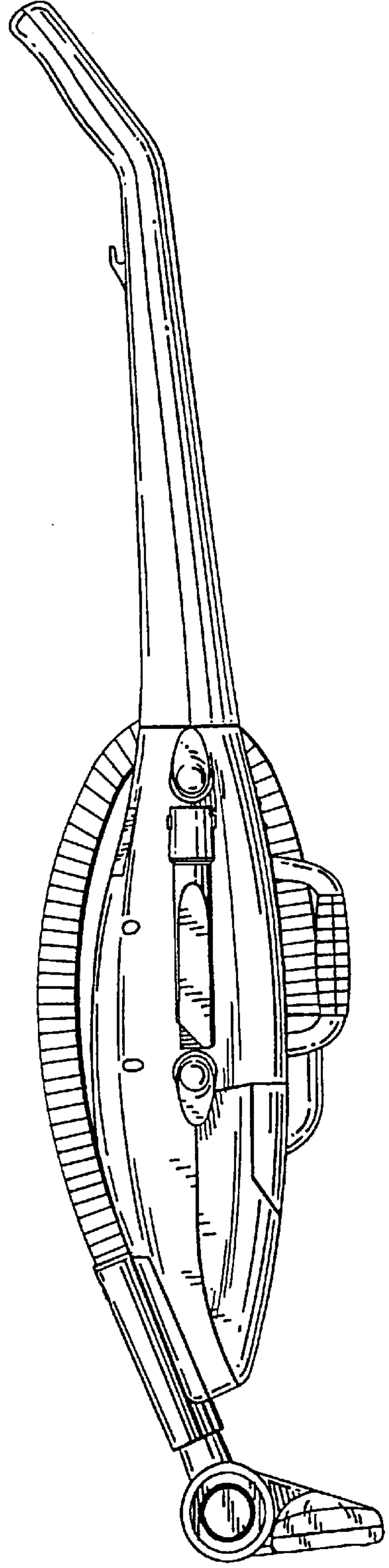

Fig. 12



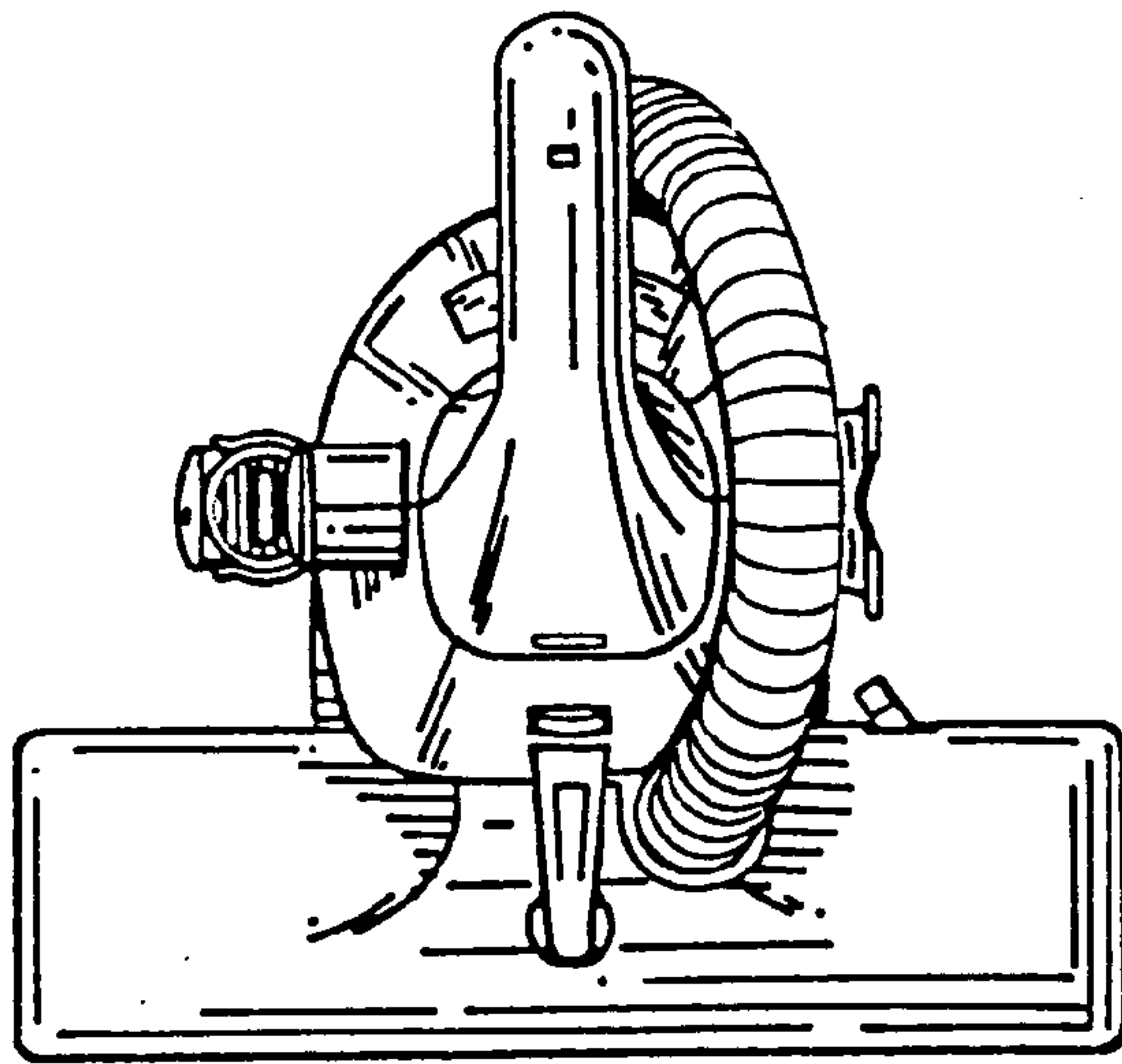

Fig. 13

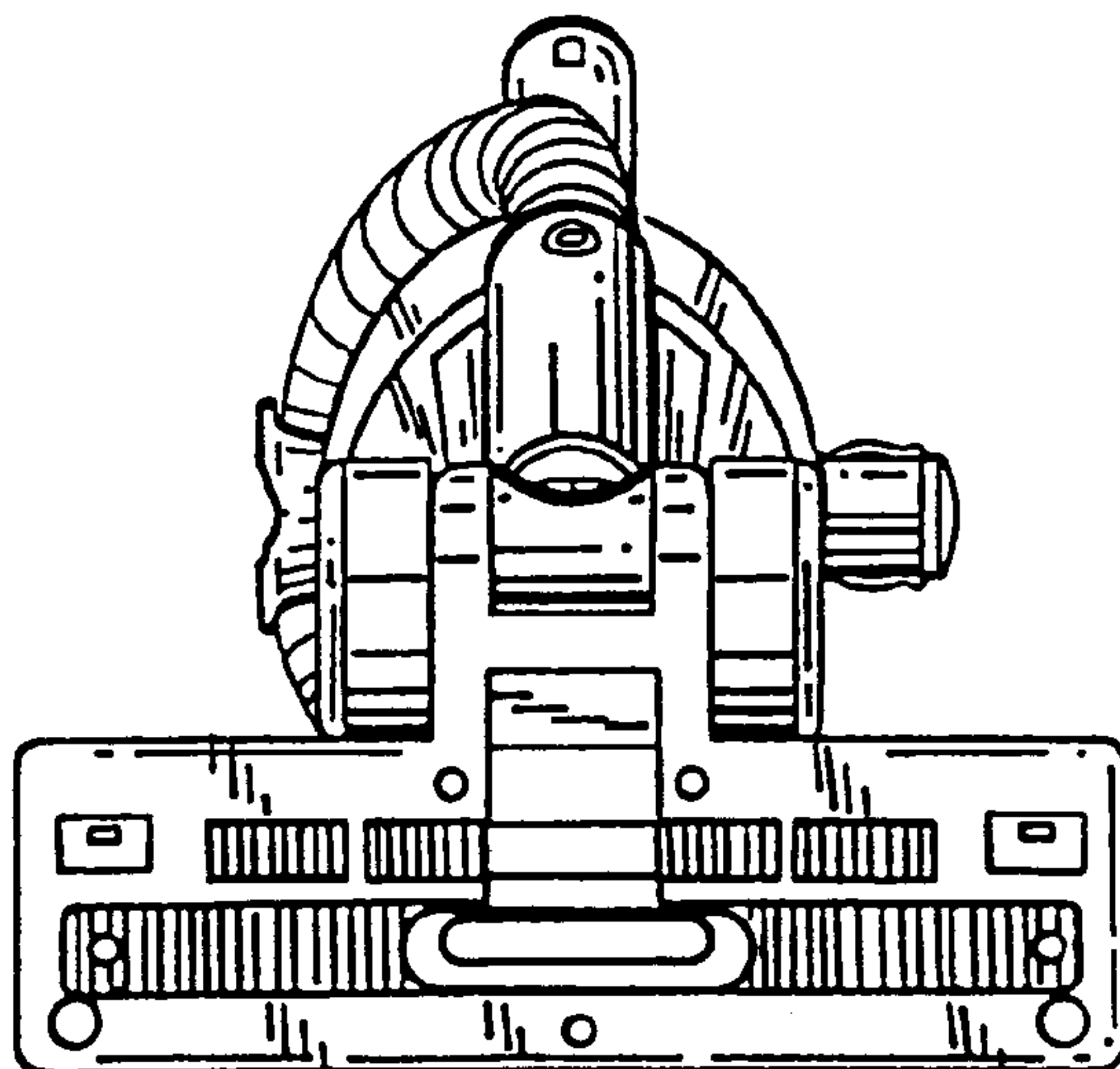

Fig. 14