



US00D418174S

United States Patent [19]

Jankowski et al.

[11] Patent Number: Des. 418,174

[45] Date of Patent: ** Dec. 28, 1999

[54] WRIST WATCH LIKE AMUSEMENT DEVICE

[75] Inventors: Bernard Jankowski, St. Louis; Ryan A. Wolfenbarger, Maplewood, both of Mo.; Chad Stuemke, Glen Carbon, Ill.

[73] Assignee: Trendmasters, Inc., St. Louis, Mo.

[**] Term: 14 Years

[21] Appl. No.: 29/088,590

[22] Filed: May 28, 1998

[51] LOC (6) Cl. 21-01

[52] U.S. Cl. D21/329; D10/46.1

[58] Field of Search D21/324, 329, D21/330, 333; 273/148 B, DIG. 26; 463/1, 4, 5, 11, 12, 29-35, 46, 47; 364/411.1; D10/46.1; 116/222-225

[56] **References Cited**

U.S. PATENT DOCUMENTS

D. 313,769	1/1991	Catuzzi	D10/46.1
D. 341,094	11/1993	Austin	D10/46.1
D. 353,110	12/1994	Calabrese et al.	D10/46.1
D. 369,754	5/1996	Donaldson	D10/46.1
D. 398,659	9/1998	Yokoi	D21/333

D. 406,613	3/1999	Nakanishi	D21/329
5,134,565	7/1992	Herbertz	364/411.1
5,181,009	1/1993	Perona	273/DIG. 26
5,184,830	2/1993	Okada et al.	463/29
5,217,295	6/1993	Tortola et al.	362/109
5,265,009	11/1993	Colavita	463/1

Primary Examiner—Prabhakar Deshmukh
Attorney, Agent, or Firm—Dorsey & Whitney LLP

[57] **CLAIM**

The ornamental design for a wrist watch like amusement device, as shown and described.

DESCRIPTION

FIG. 1 is a perspective view of wrist watch like amusement device showing our new design; FIG. 2 is a top plan view of FIG. 1; FIG. 3 is a bottom plan view of FIG. 1; FIG. 4 is a elevational view of one side of FIG. 1; FIG. 5 is a elevational view of the opposite side of FIG. 1; FIG. 6 is a elevational view of the one end of FIG. 1; and, FIG. 7 is a elevational view of the opposite end of FIG. 1. Any broken lines in the accompanying drawings show structures for illustrative purposes only and form no part of the claimed design.

1 Claim, 2 Drawing Sheets

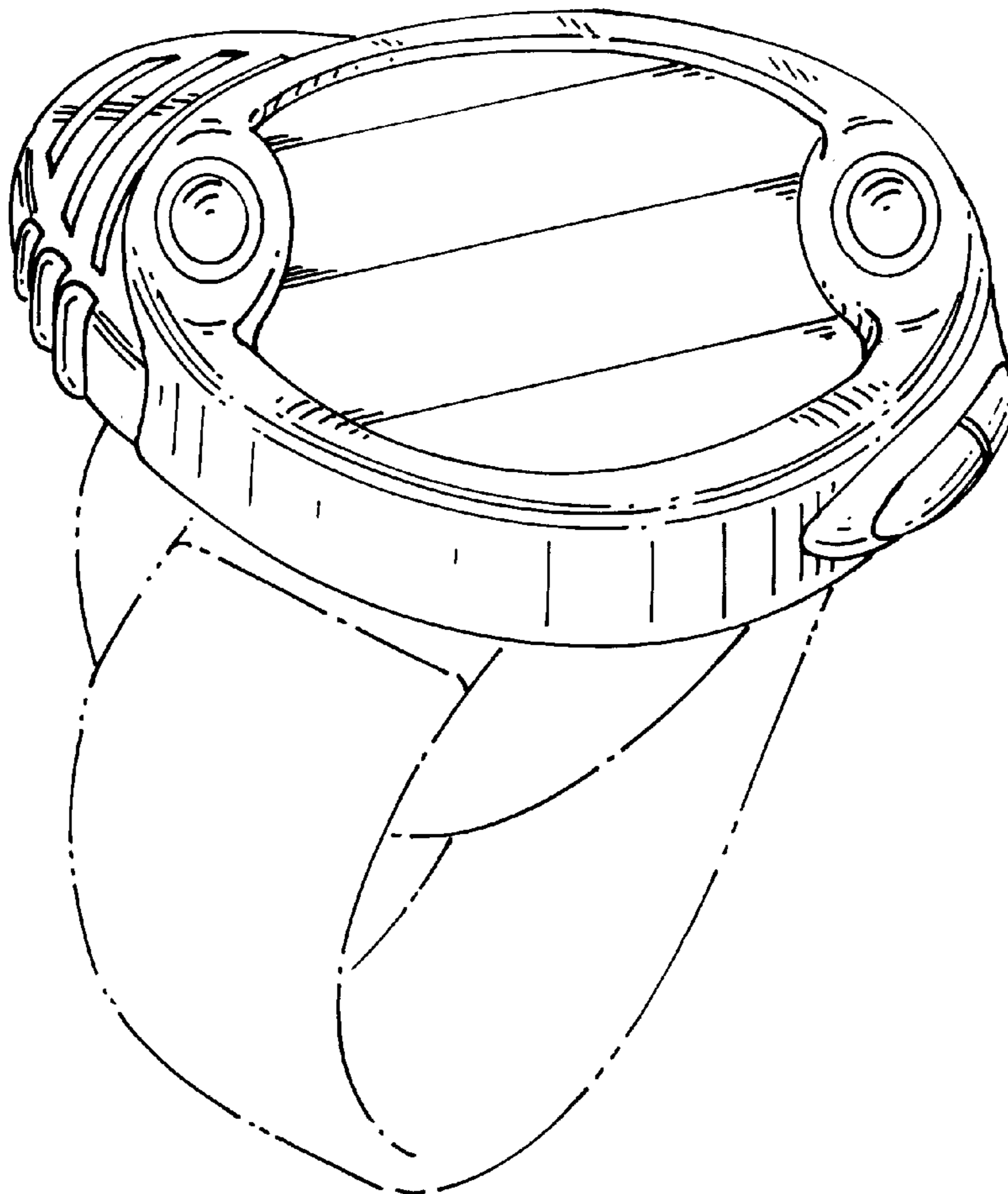

Fig. 1

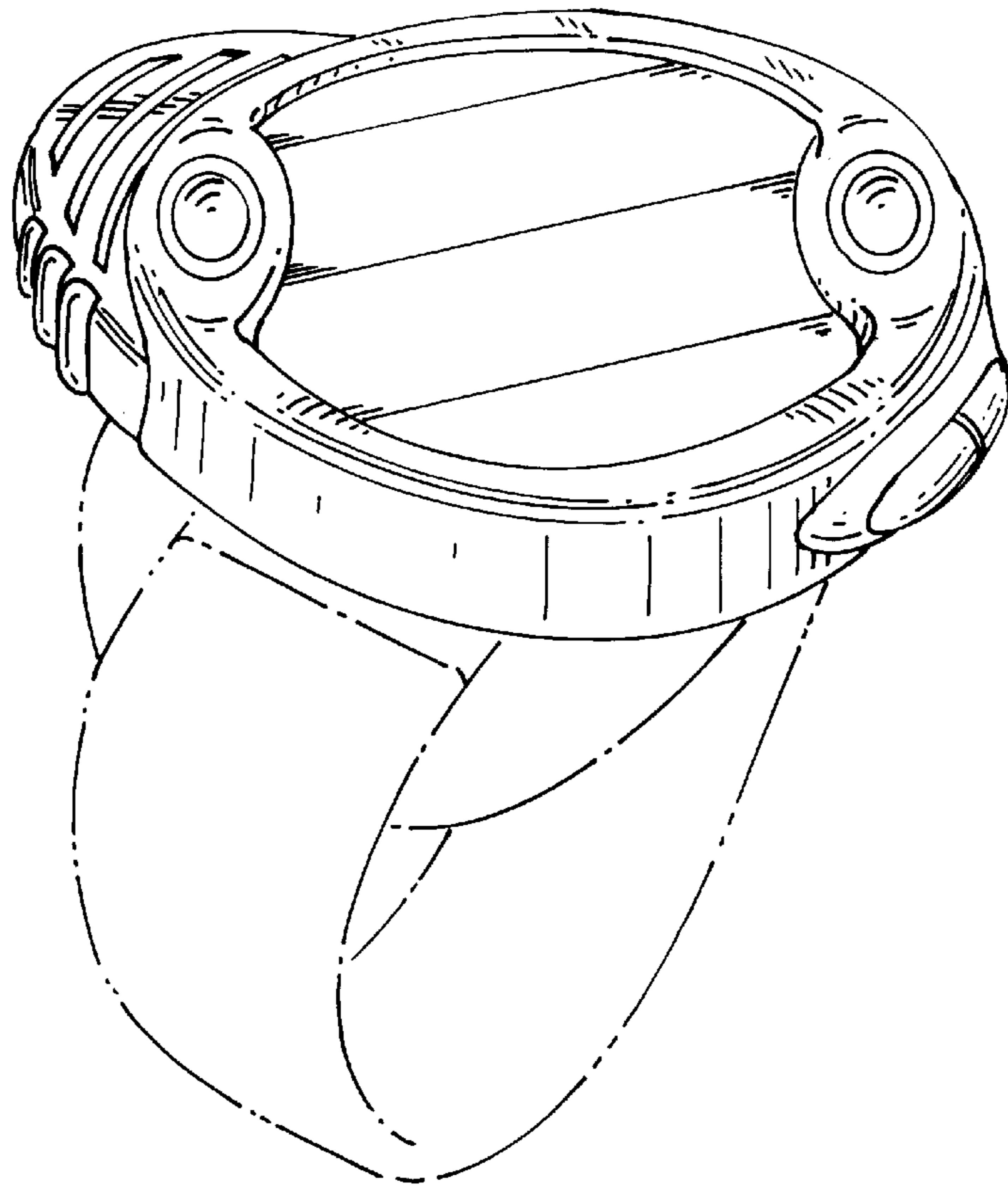

Fig. 6

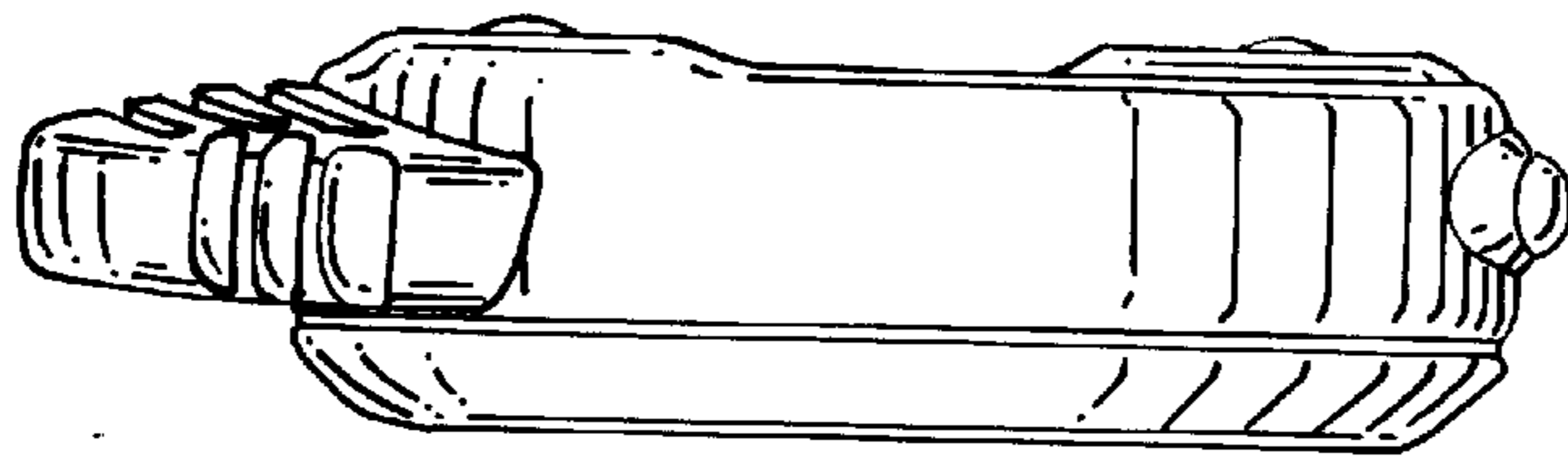

Fig. 7

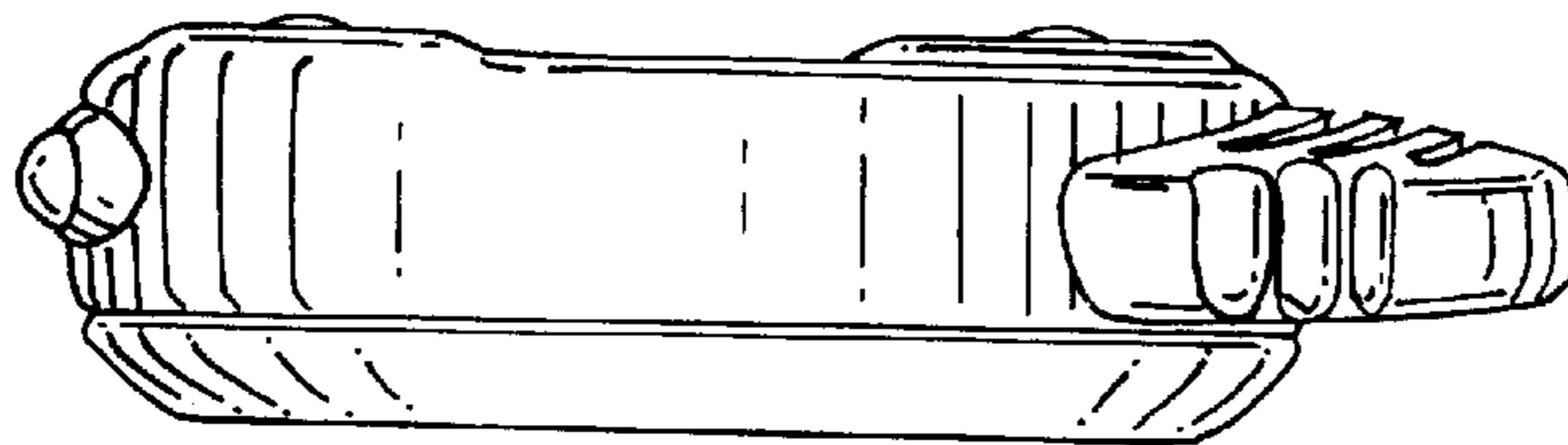

Fig. 2

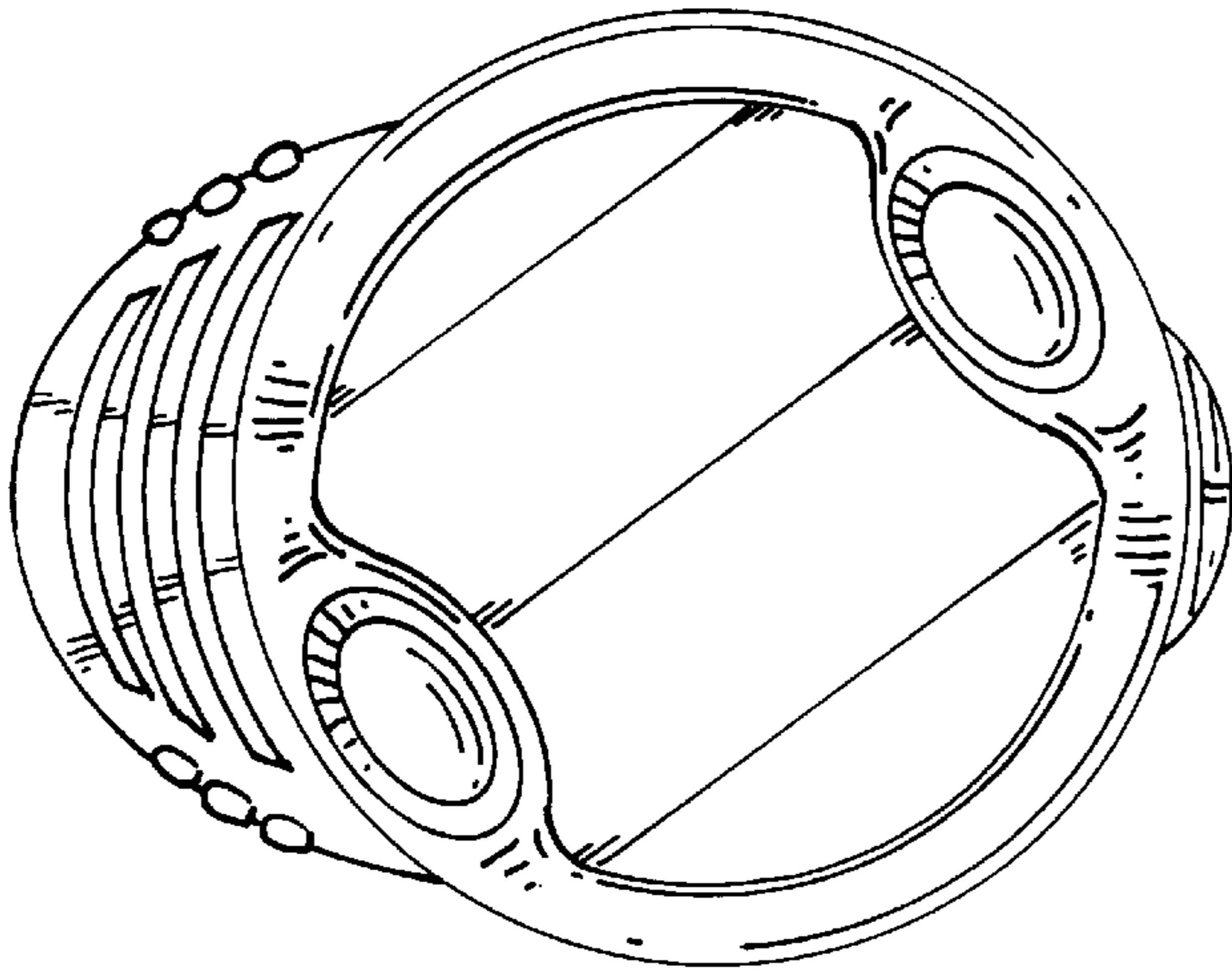

Fig. 3

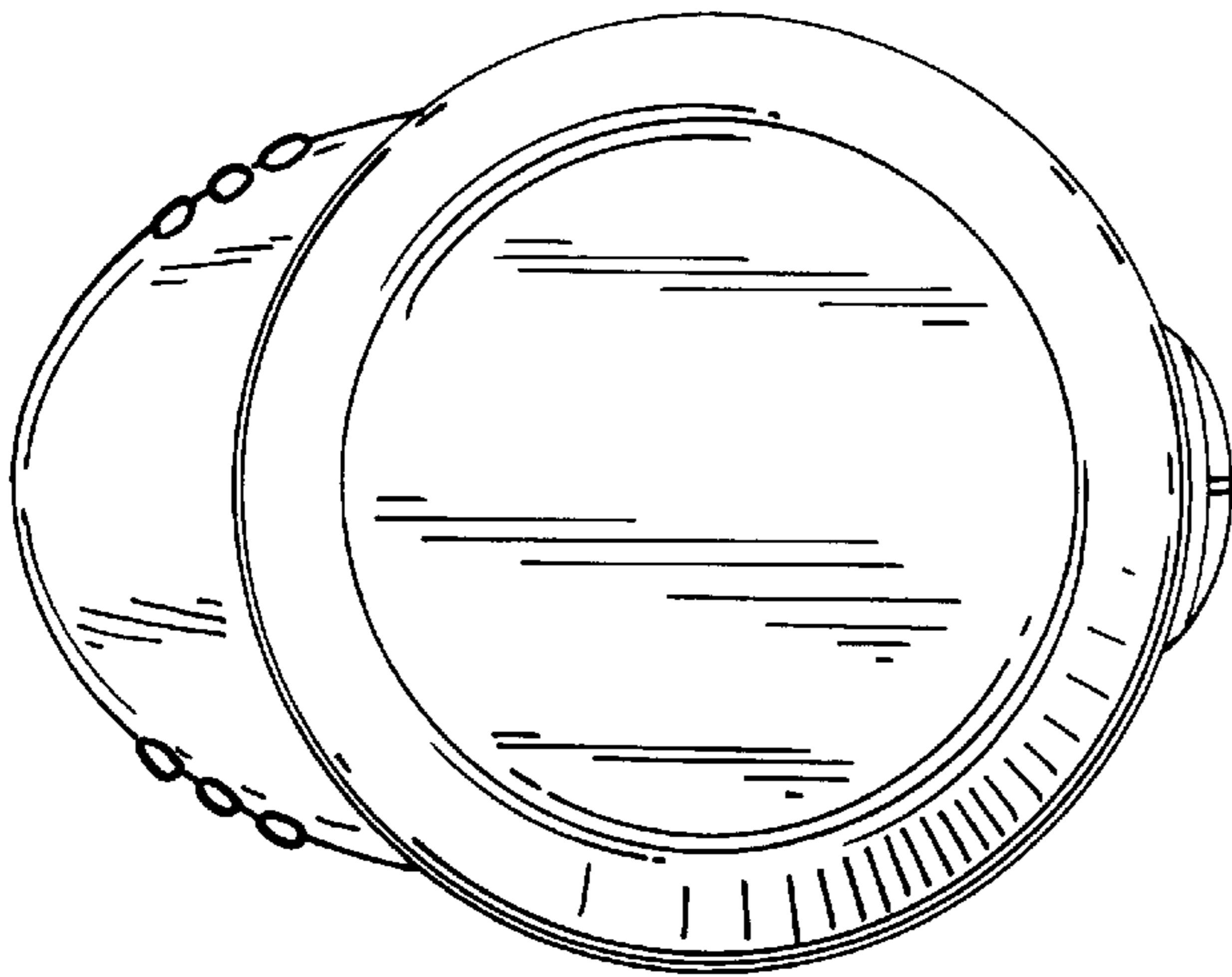

Fig. 5

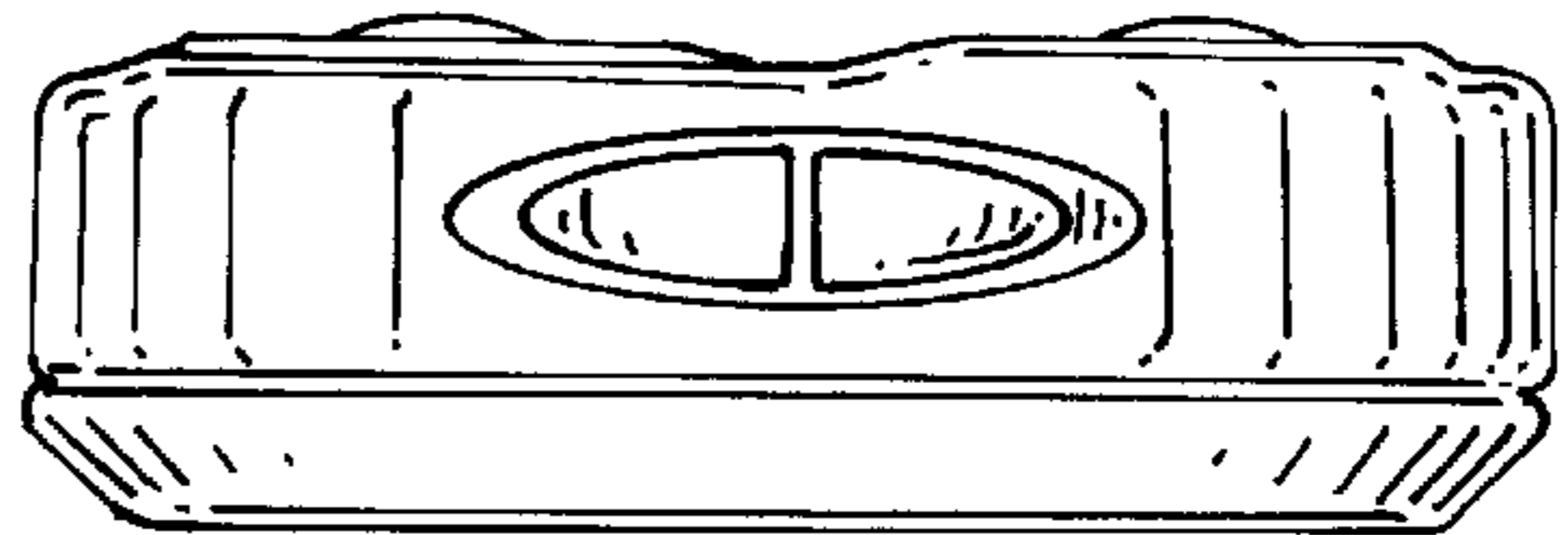

Fig. 4