



US00D418166S

United States Patent [19]
Dill

[11] **Patent Number: Des. 418,166**

[45] **Date of Patent: ** Dec. 28, 1999**

[54] **SHEET HOLDER**

[76] Inventor: **Etienne Dill**, 28, Rue Me hul, 93500
Pantin, France

[**] Term: **14 Years**

[21] Appl. No.: **29/069,237**

[22] Filed: **Mar. 17, 1997**

[30] **Foreign Application Priority Data**

Mar. 11, 1997 [FR] France 97 1453

[51] **LOC (6) Cl.** **19-02**

[52] **U.S. Cl.** **D19/88; D19/90; D19/91;**
D6/310

[58] **Field of Search** D6/300, 310; 40/124.01;
D19/35, 36, 41-51, 53-58, 81-85, 86, 88,
90, 91, 95, 99, 100; 248/441.1, 442.2, 450,
451, 453, 910, 473

[56] **References Cited**

U.S. PATENT DOCUMENTS

D. 48,746 3/1916 Foster D6/310
D. 101,143 9/1936 Shank D6/310
D. 181,114 10/1957 Turner D19/51 X

D. 407,440 3/1999 Vanlandingham, Jr. D19/88
1,630,373 5/1927 Combs 248/473
2,497,418 2/1950 Schroeder, Jr. D19/36 X
2,832,176 4/1958 Vergeer 40/124.01
4,125,243 11/1978 Lijstak 248/473

FOREIGN PATENT DOCUMENTS

59-24383 2/1984 Japan .

Primary Examiner—Martie K. Holtje
Attorney, Agent, or Firm—Greenblum & Bernstein, P.L.C.

[57] **CLAIM**

I claim the ornamental design for a sheet holder, as shown and described.

DESCRIPTION

FIG. 1 is a perspective view of a sheet holder, showing my new design;
FIG. 2 is a front elevation view thereof;
FIG. 3 is a rear elevation view thereof;
FIG. 4 is a right side elevation view thereof;
FIG. 5 is a left side elevation view thereof;
FIG. 6 is a bottom plan view thereof; and,
FIG. 7 is a top plan view thereof.

1 Claim, 1 Drawing Sheet

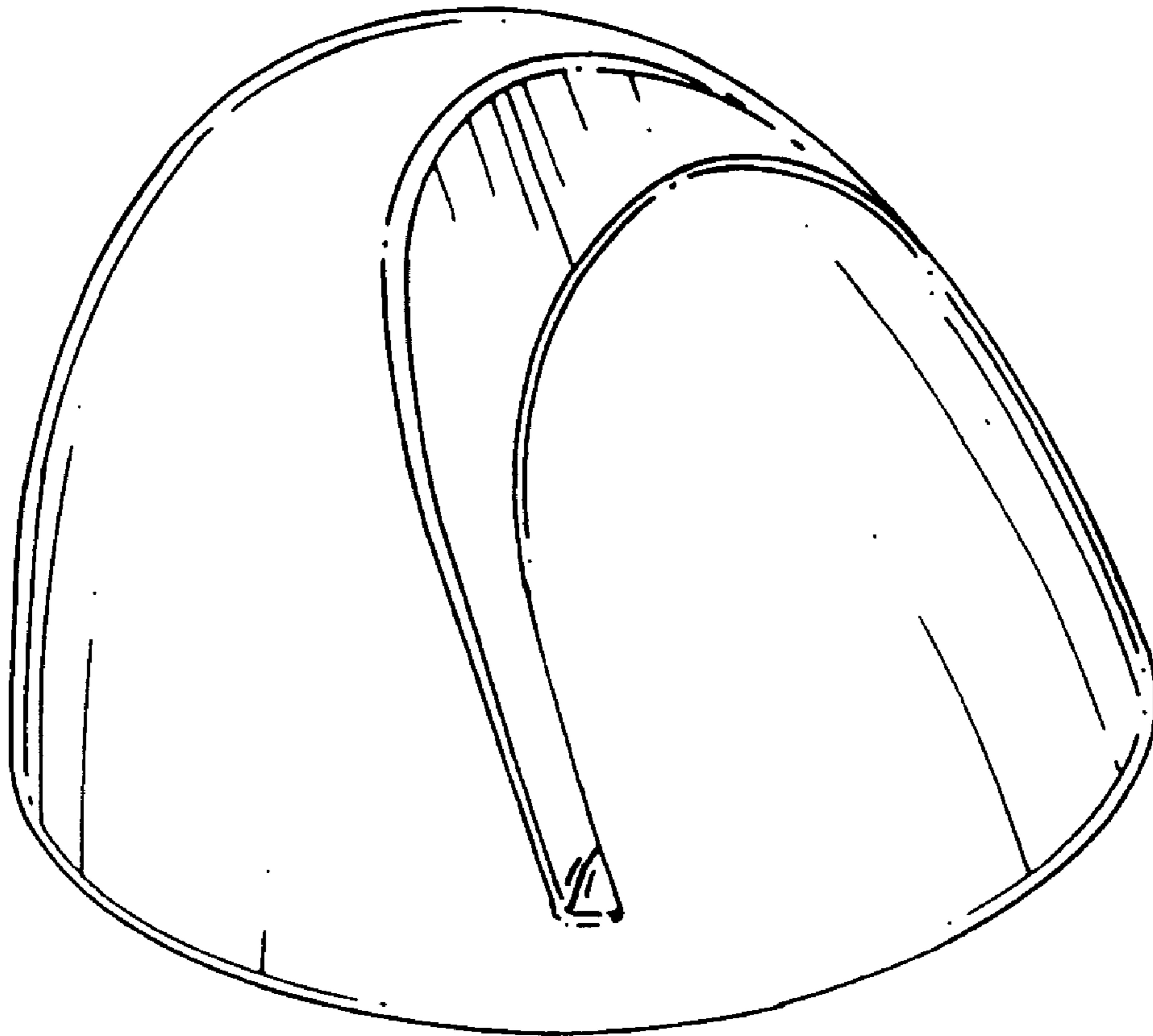

Fig. 1

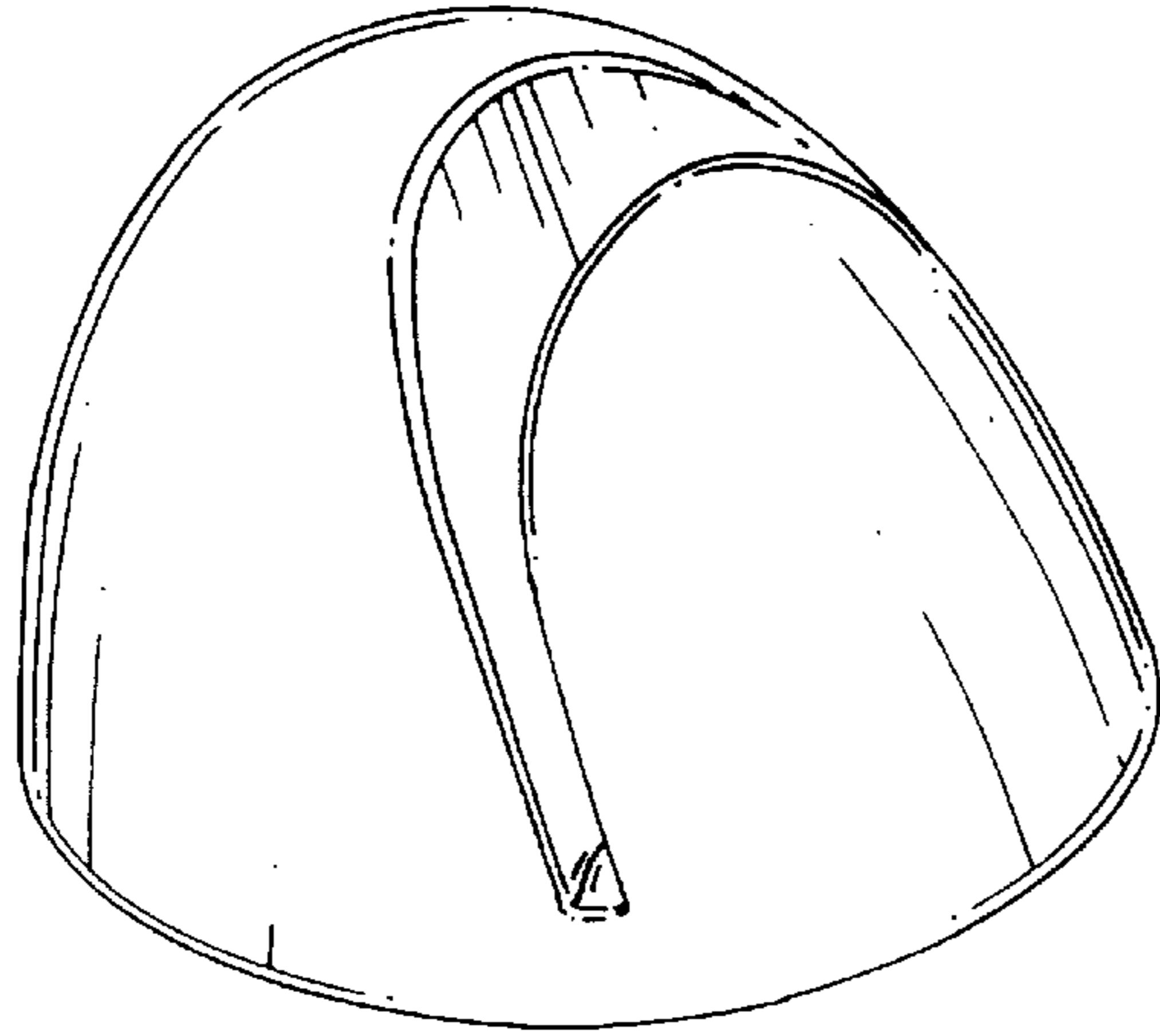

Fig. 2

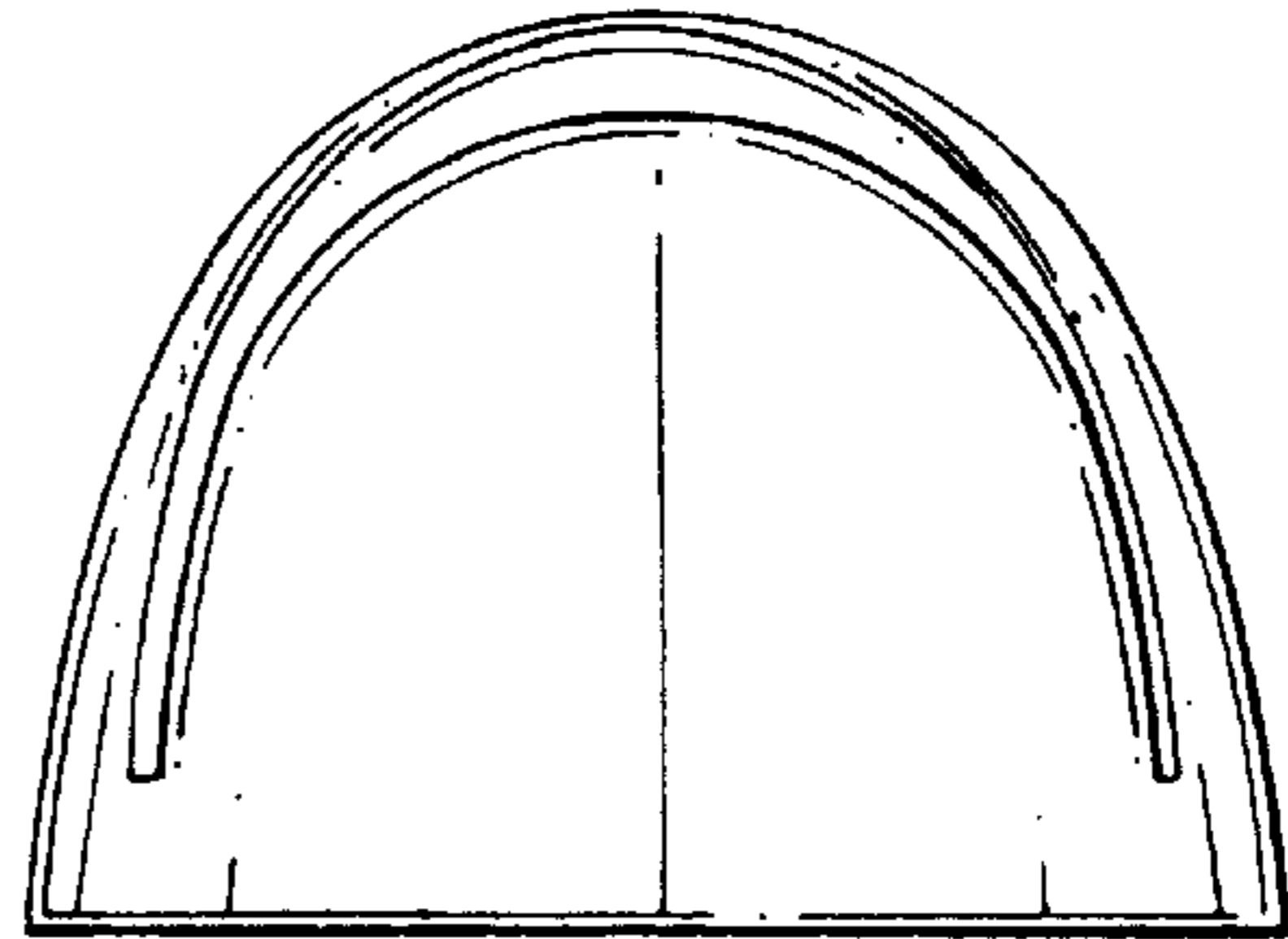

Fig. 3

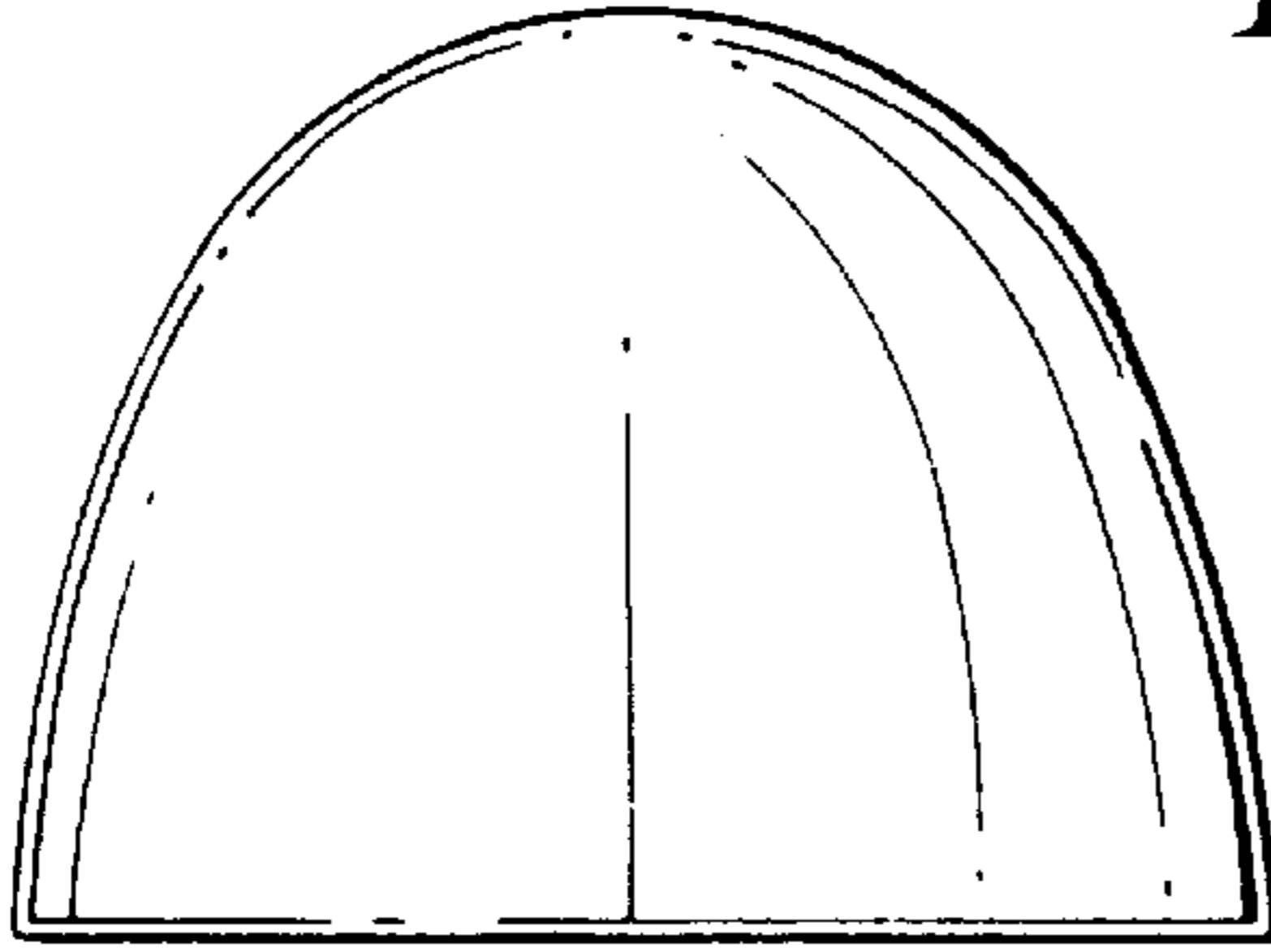

Fig. 4

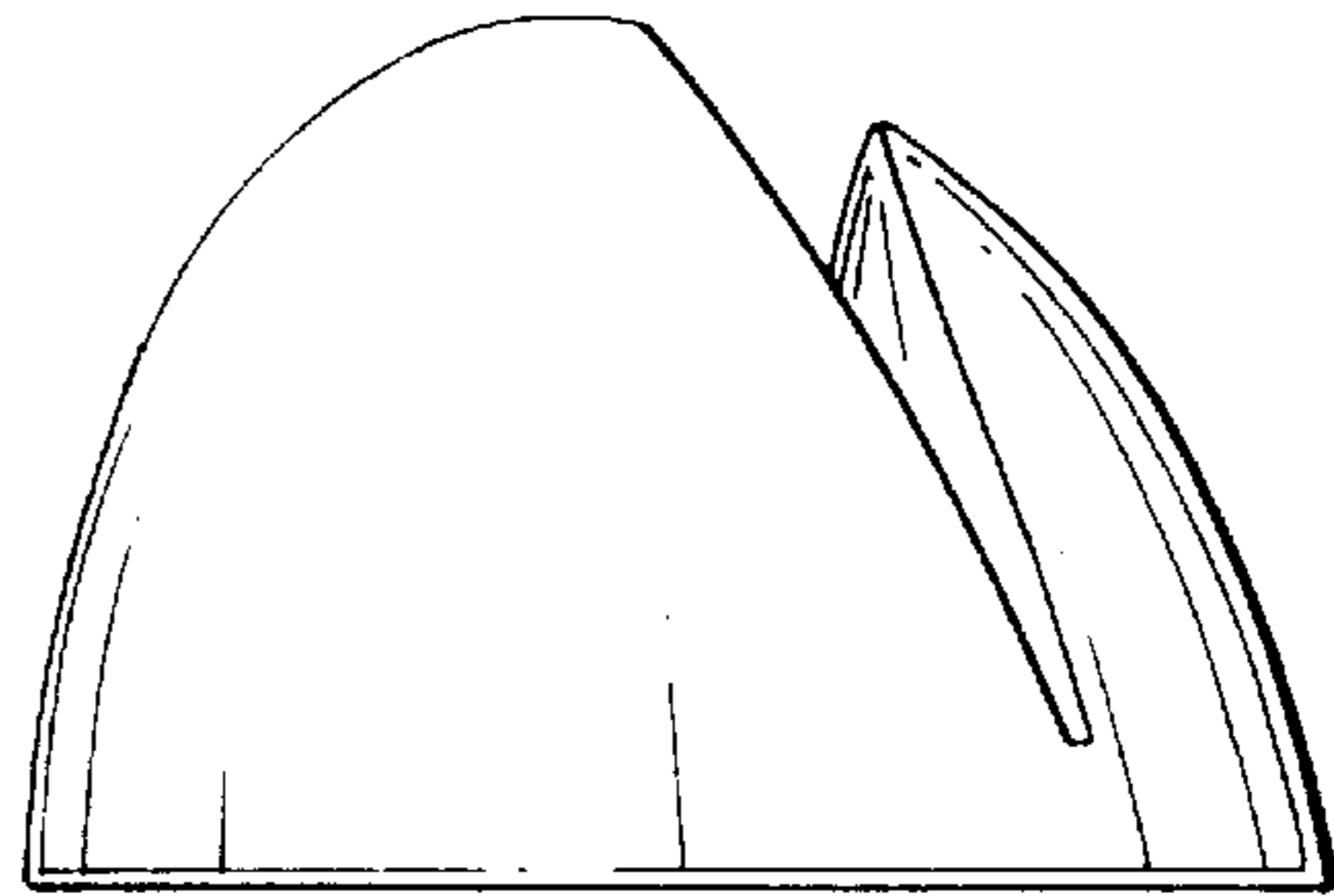

Fig. 5

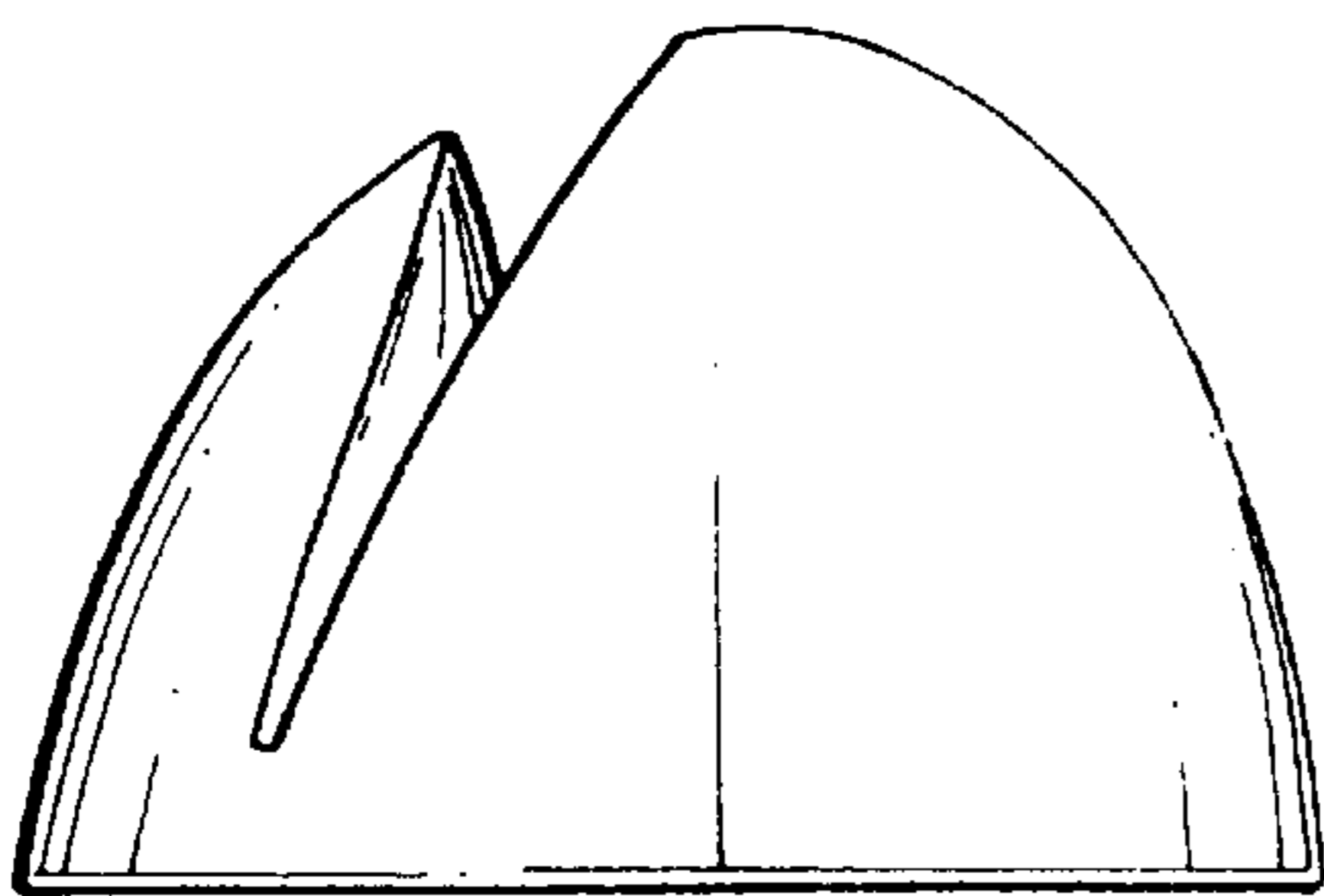

Fig. 7

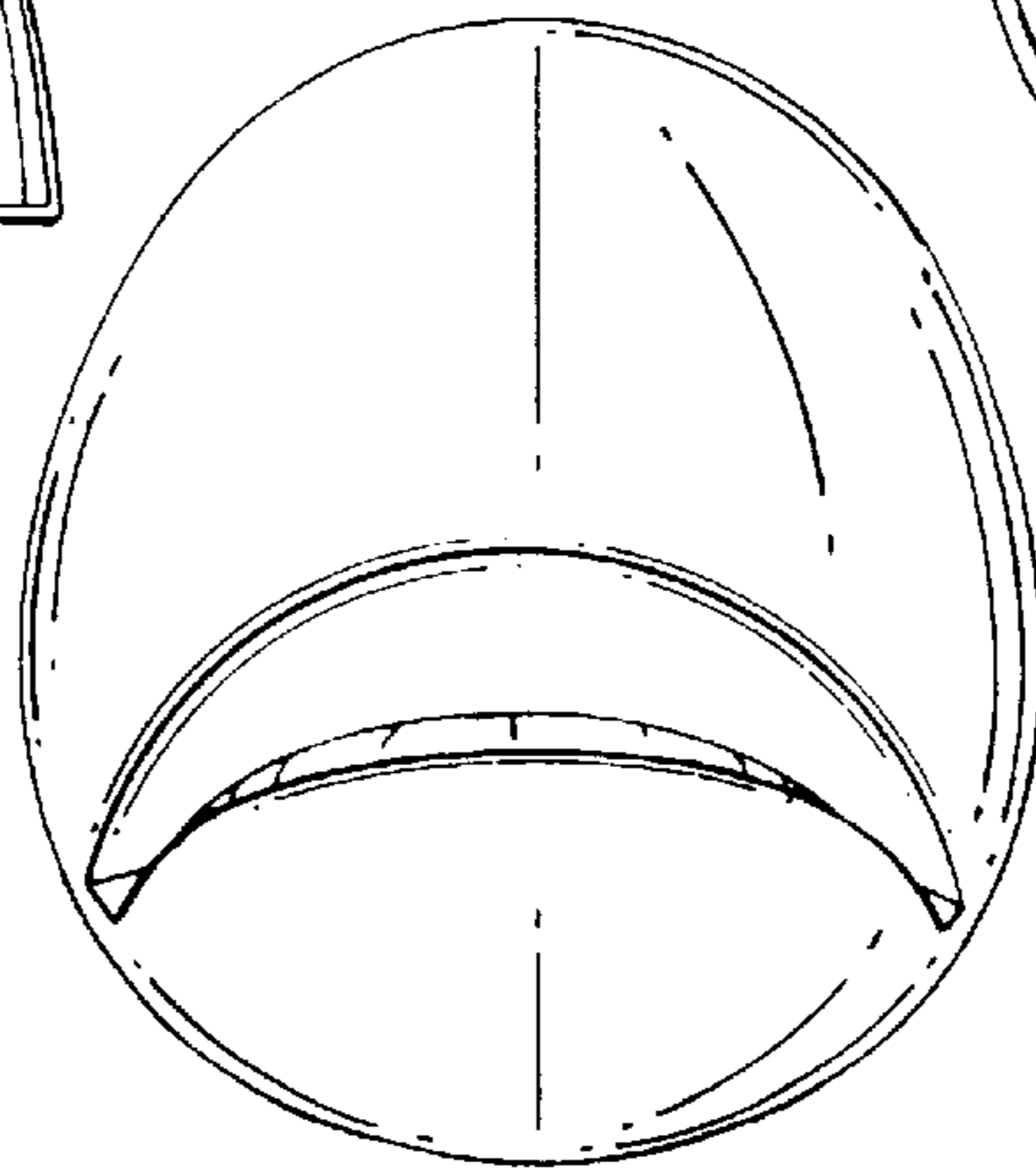

Fig. 6

