



US00D418127S

United States Patent [19] Tsong

[11] **Patent Number: Des. 418,127**

[45] **Date of Patent: ** Dec. 28, 1999**

[54] **COMPUTER MOUSE**

D. 386,165 11/1997 Tseng D14/114

[75] Inventor: **Tu Kenneth Tsung**, Walnut, Calif.

Primary Examiner—Kay H. Chin
Attorney, Agent, or Firm—Rosenberg, Klein & Lee

[73] Assignee: **XNTC New Tech. (H.K.) Corp.**, Kln,
The Hong Kong Special Administrative
Region of the People's Republic of
China

[57] **CLAIM**

The ornamental design for a "computer mouse", as shown and described.

[**] Term: **14 Years**

DESCRIPTION

[21] Appl. No.: **29/088,873**

FIG. 1 is the perspective view of a "computer mouse" showing my new design;

[22] Filed: **Jun. 2, 1998**

FIG. 2 is the front elevational view thereof;

[51] **LOC (6) Cl.** **14-02**

FIG. 3 is the rear elevational view thereof;

[52] **U.S. Cl.** **D14/117.3**

FIG. 4 is the left side elevational view thereof;

[58] **Field of Search** D14/114, 117.1,
D14/117.2, 117.3; D21/333; 345/156-167

FIG. 5 is the right side elevational view thereof;

FIG. 6 is the top plan view thereof; and,

FIG. 7 is the bottom plan view thereof.

[56] **References Cited**

U.S. PATENT DOCUMENTS

D. 385,862 11/1997 Tseng D14/114

1 Claim, 4 Drawing Sheets

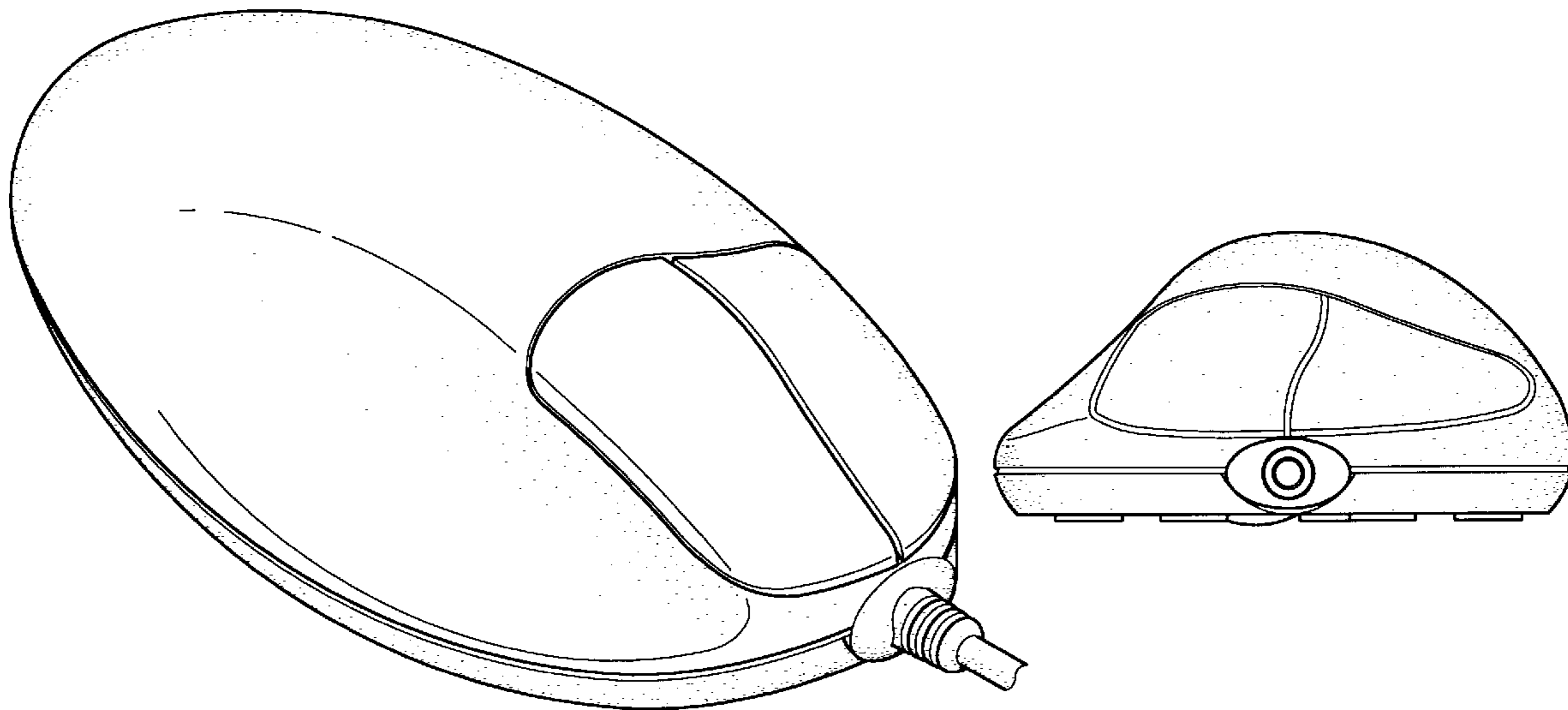

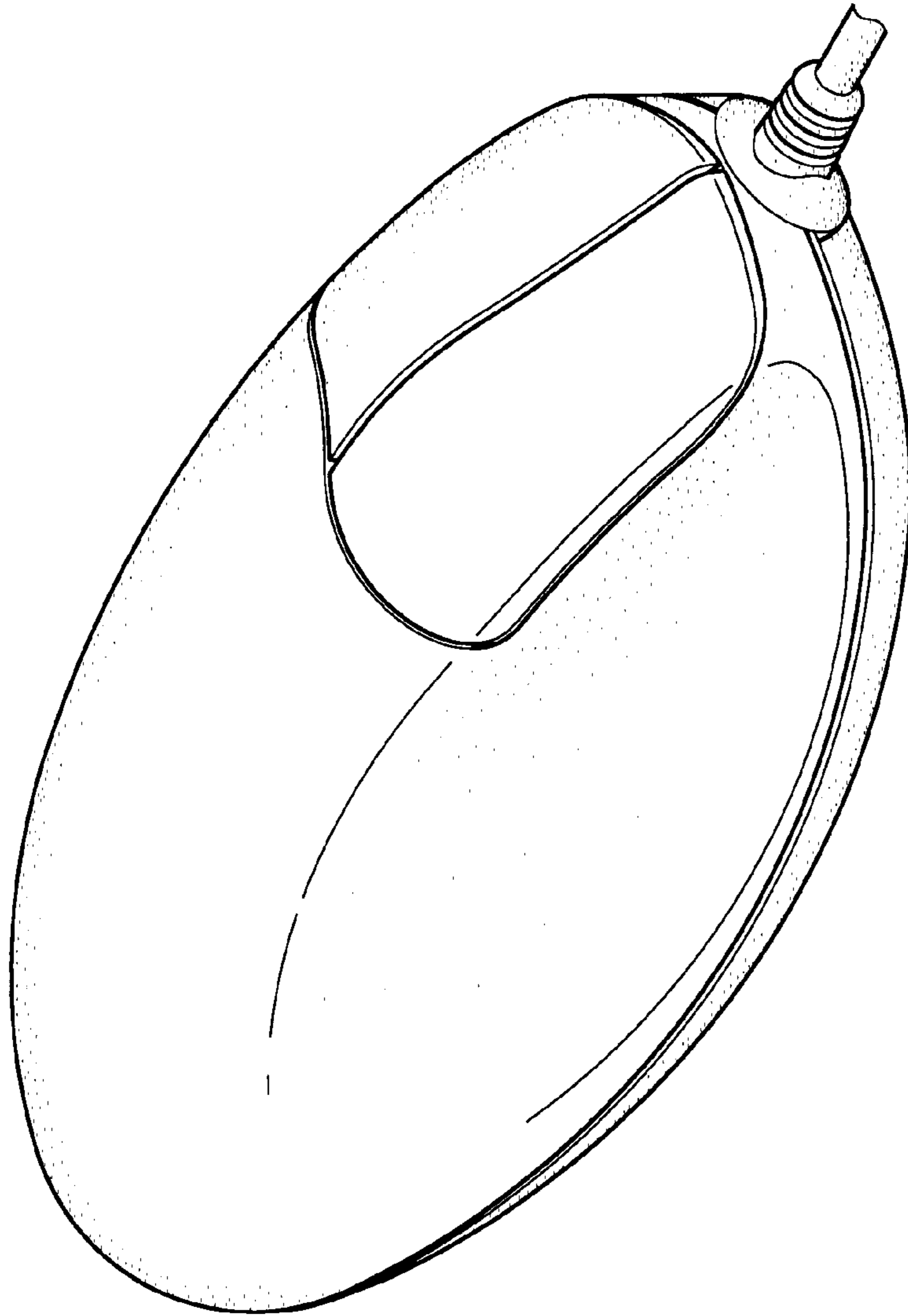

FIG. 1

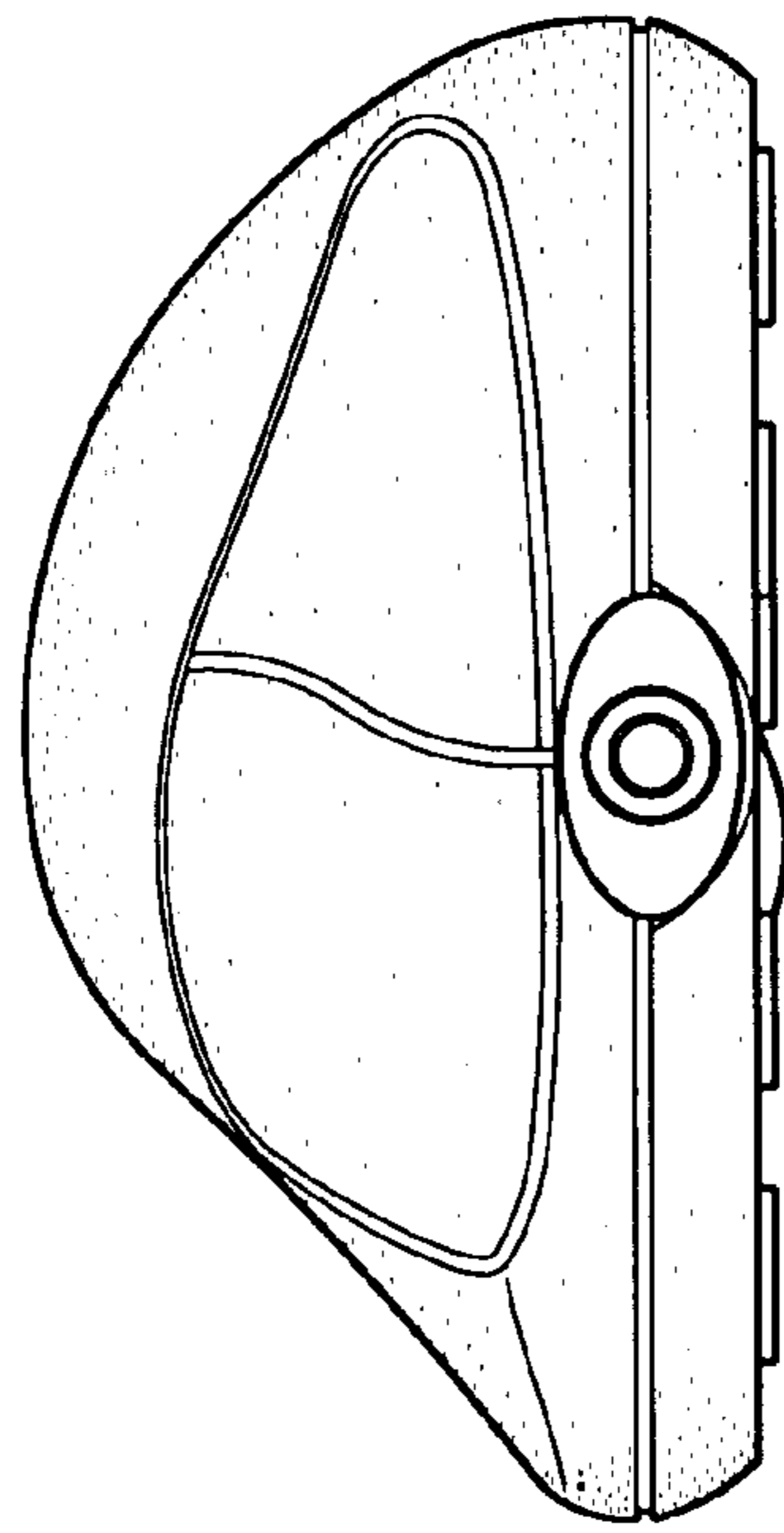

FIG. 2

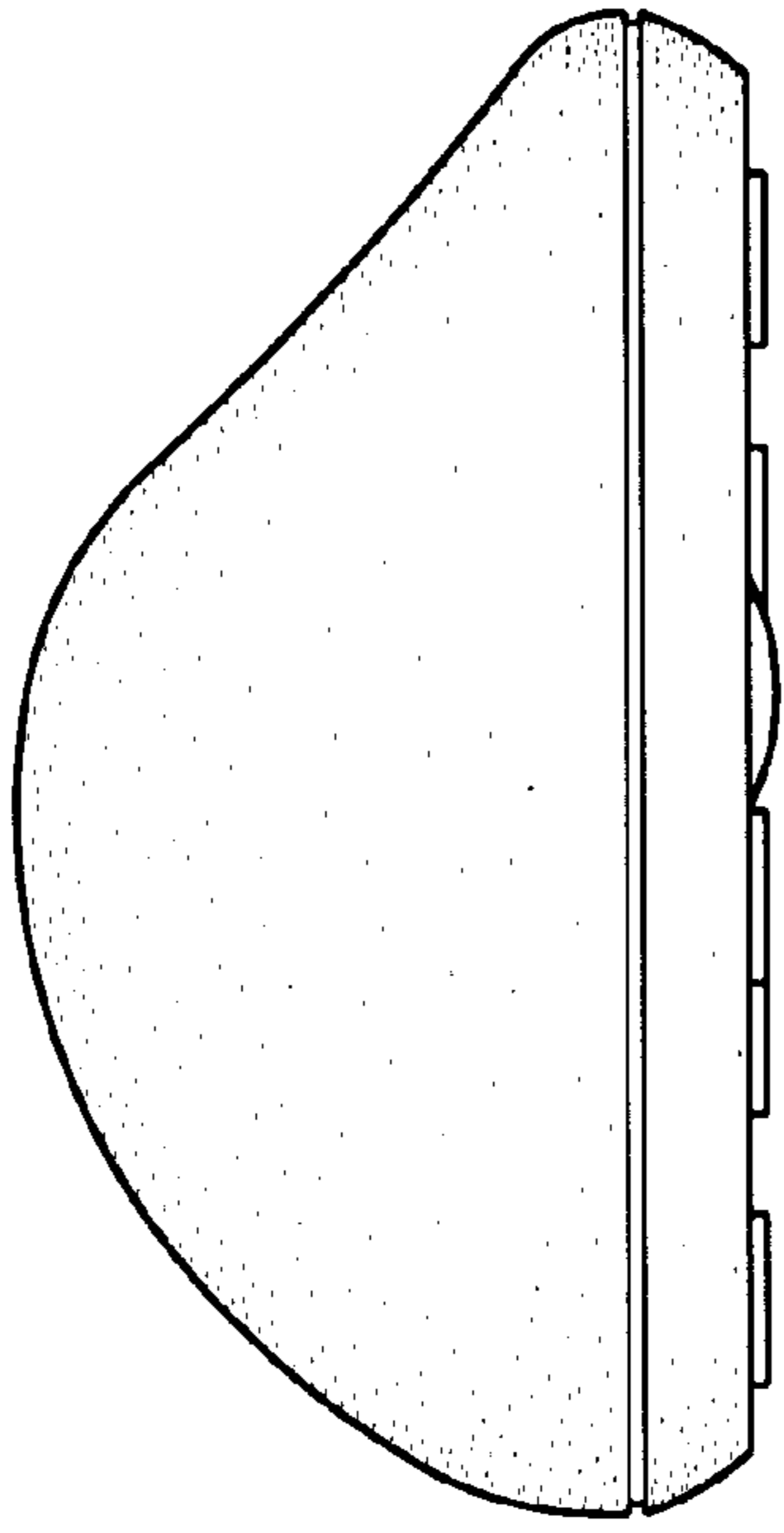

FIG. 3

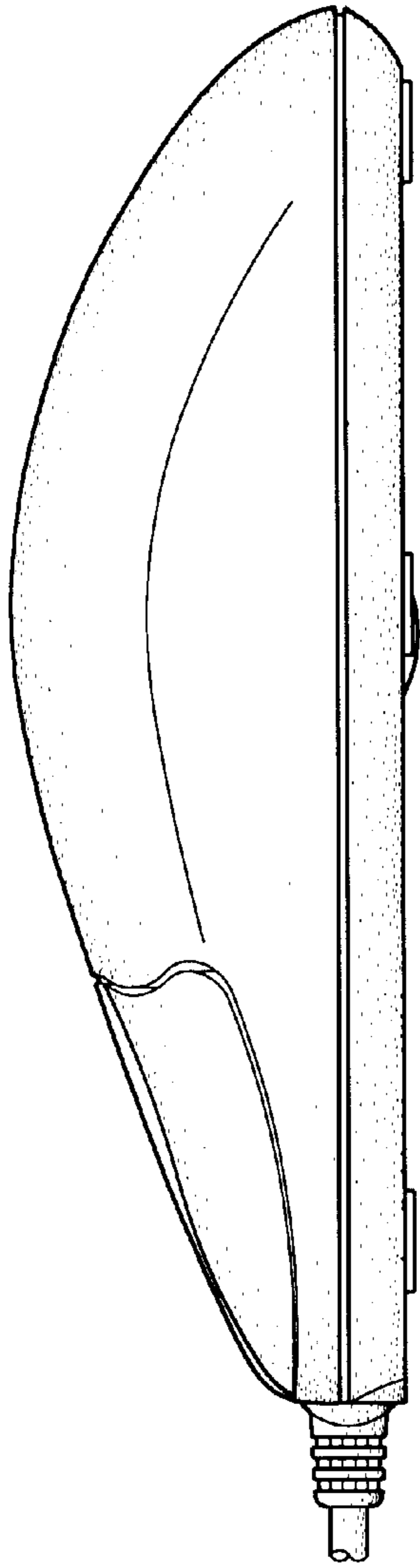

FIG. 4

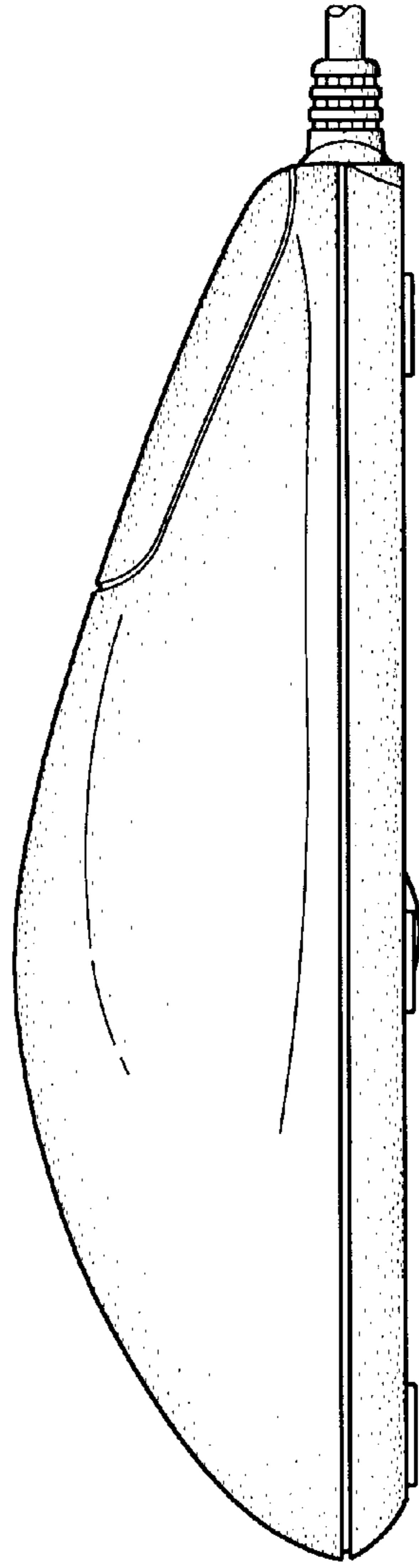

FIG. 5

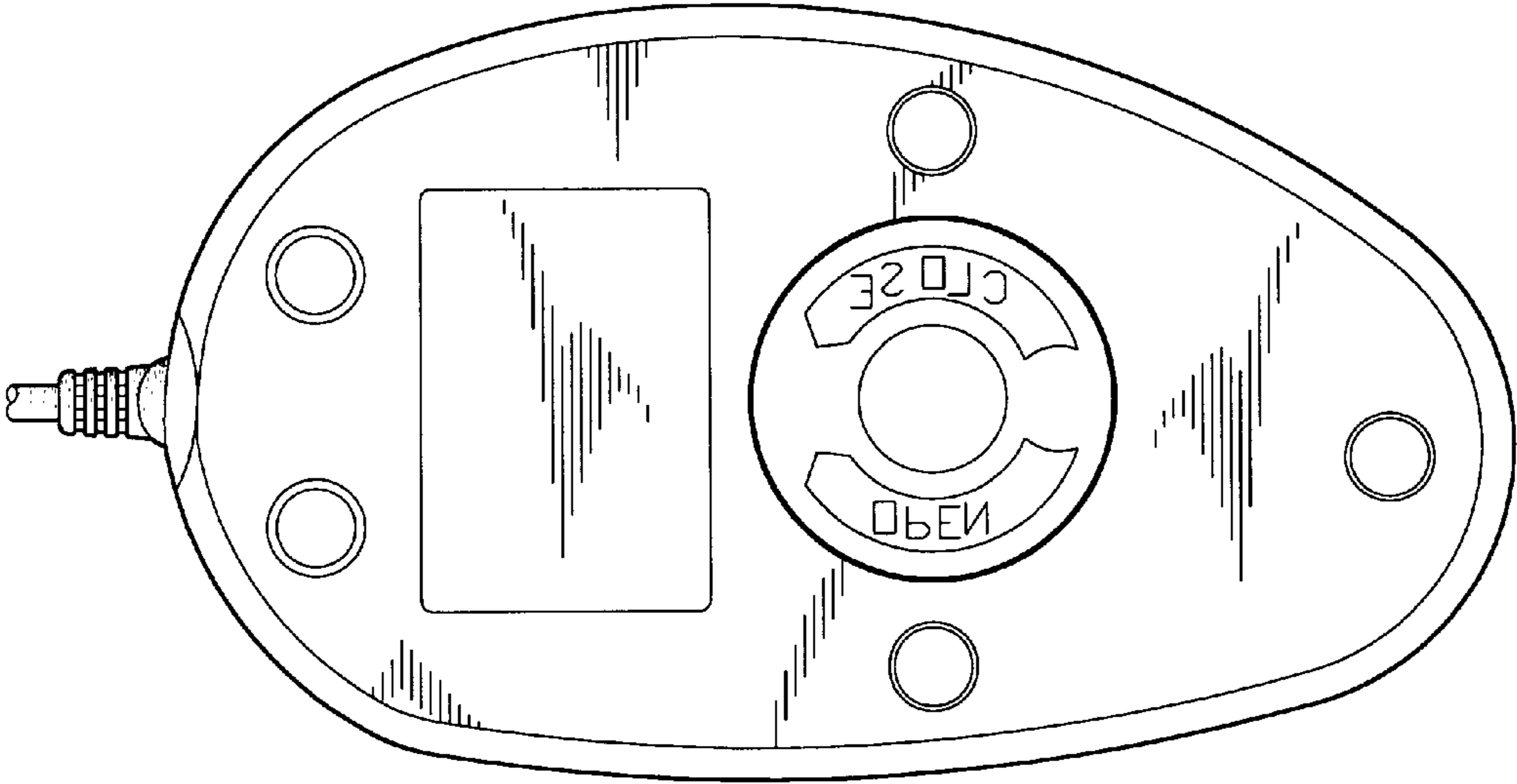

FIG. 7

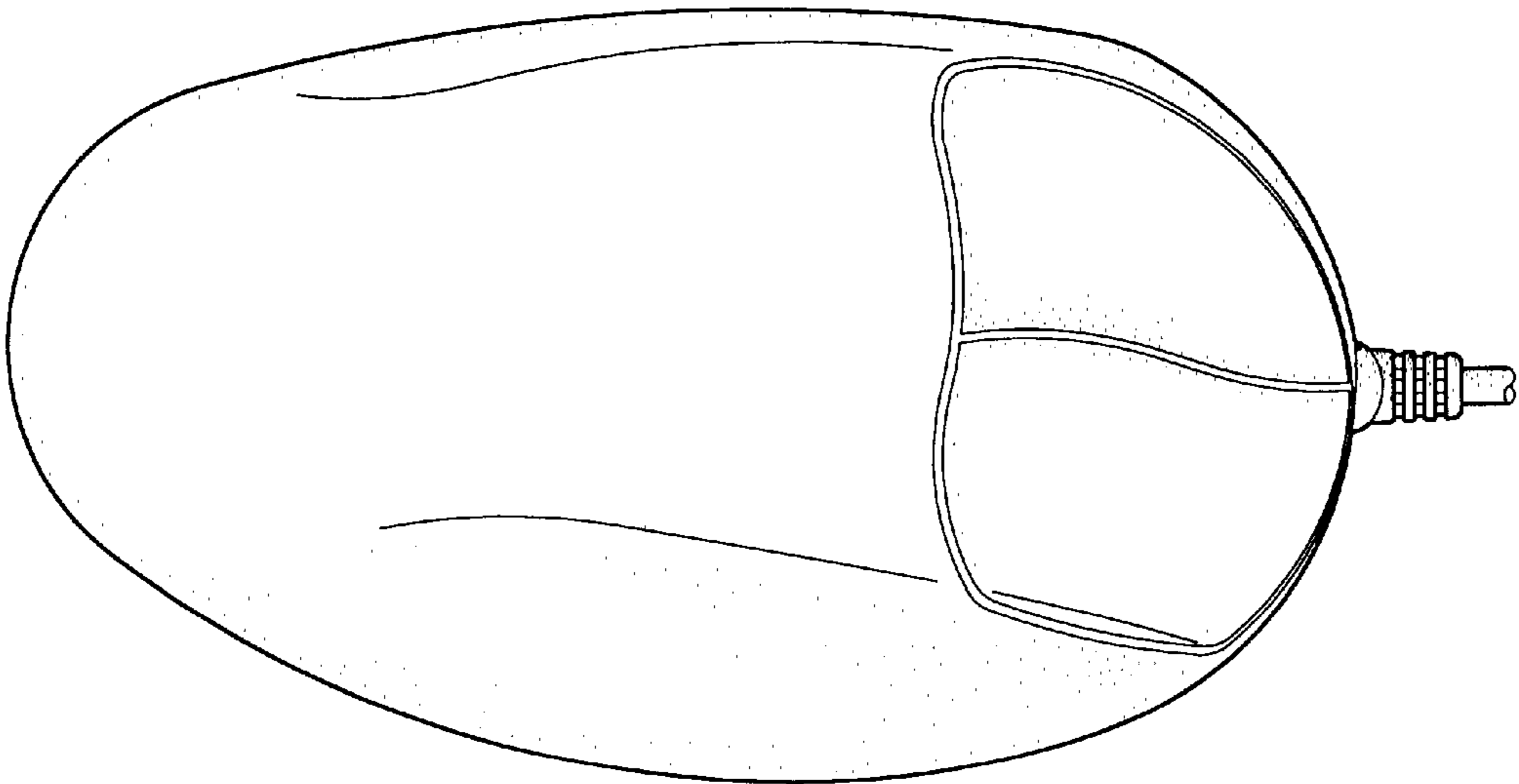

FIG. 6