



US00D418111S

United States Patent [19]
Kamagai

[11] **Patent Number: Des. 418,111**

[45] **Date of Patent: ** Dec. 28, 1999**

[54] **CONNECTOR**

[75] Inventor: **Izuru Kamagai**, Kawasaki, Japan

[73] Assignee: **Thomas & Betts International, Inc.**,
Sparks, Nev.

[**] Term: **14 Years**

[21] Appl. No.: **29/063,109**

[22] Filed: **Nov. 27, 1996**

[51] **LOC (6) Cl.** **13-03**

[52] **U.S. Cl.** **D13/147**

[58] **Field of Search** D13/146, 147;
439/79, 101, 108, 283, 291, 608

[56] **References Cited**

U.S. PATENT DOCUMENTS

3,070,769	12/1962	Murphy	439/291
3,838,380	9/1974	Stieler	439/101
5,160,273	11/1992	Carney	439/108
5,611,700	3/1997	Mitra	439/101
5,688,129	11/1997	Flaherty	439/79

Primary Examiner—Holly Baynham

Assistant Examiner—Lavone D. Tabor

Attorney, Agent, or Firm—Brian S. Welborn

[57] **CLAIM**

The ornamental design for a connector, as shown and described.

DESCRIPTION

FIG. 1 is a front view of the connector showing my new design;

FIG. 2 is a rear view thereof;

FIG. 3 is a top plan view thereof;

FIG. 4 is a left side view thereof;

FIG. 5 is a bottom plan view thereof;

FIG. 6 is a right side view thereof;

FIG. 7 is a front view of the female component of the connector, shown separately for clarity of illustration only;

FIG. 8 is a rear view of FIG. 7;

FIG. 9 is a top plan view of FIG. 7;

FIG. 10 is a left side view of FIG. 7;

FIG. 11 is a right side view of FIG. 7;

FIG. 12 is a bottom plan view of FIG. 7;

FIG. 13 is a front view of the male component of the connector, shown separately for clarity of illustration only;

FIG. 14 is a rear view of the FIG. 13;

FIG. 15 is a top plan view of FIG. 13;

FIG. 16 is a right side view of FIG. 13;

FIG. 17 is a bottom plan view of FIG. 13;

FIG. 18 is a perspective view of FIG. 7; and,

FIG. 19 is a perspective view of FIG. 13.

1 Claim, 4 Drawing Sheets

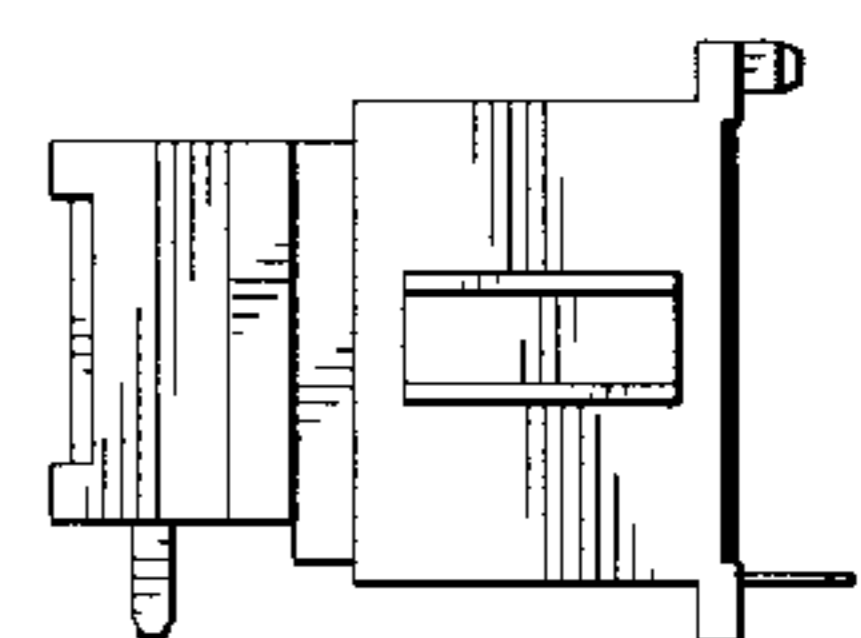
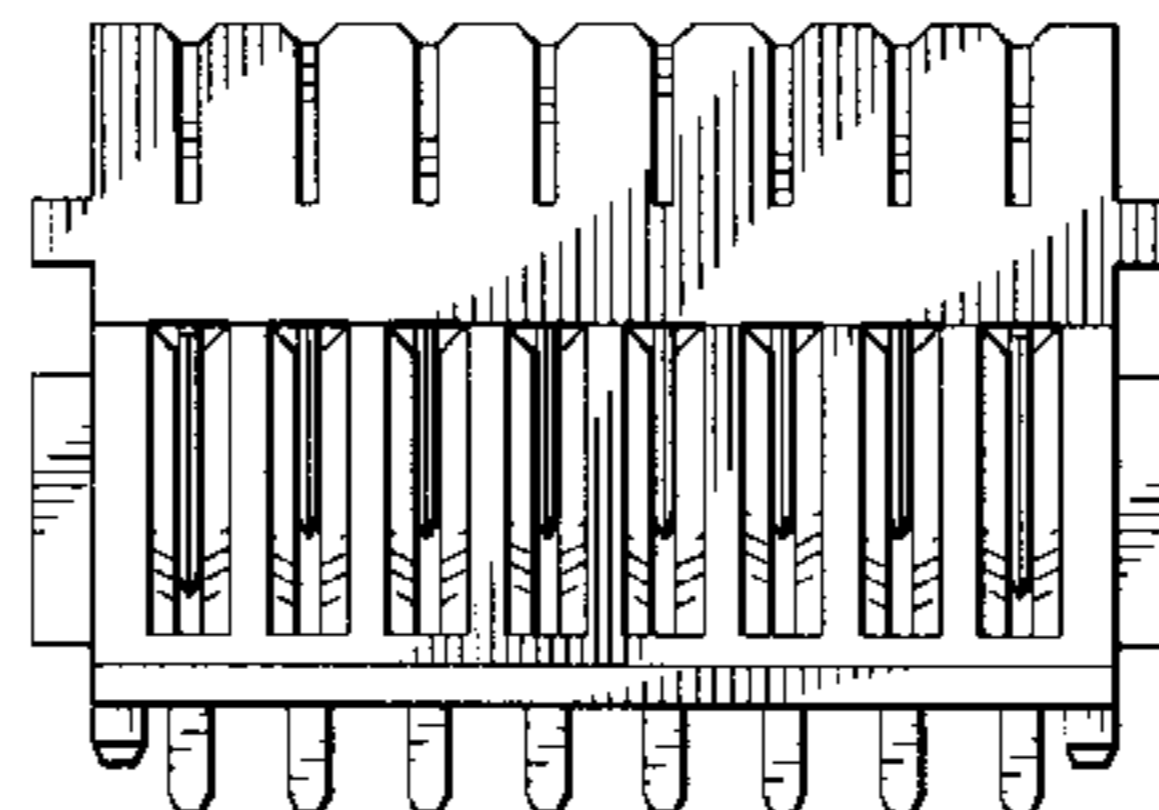
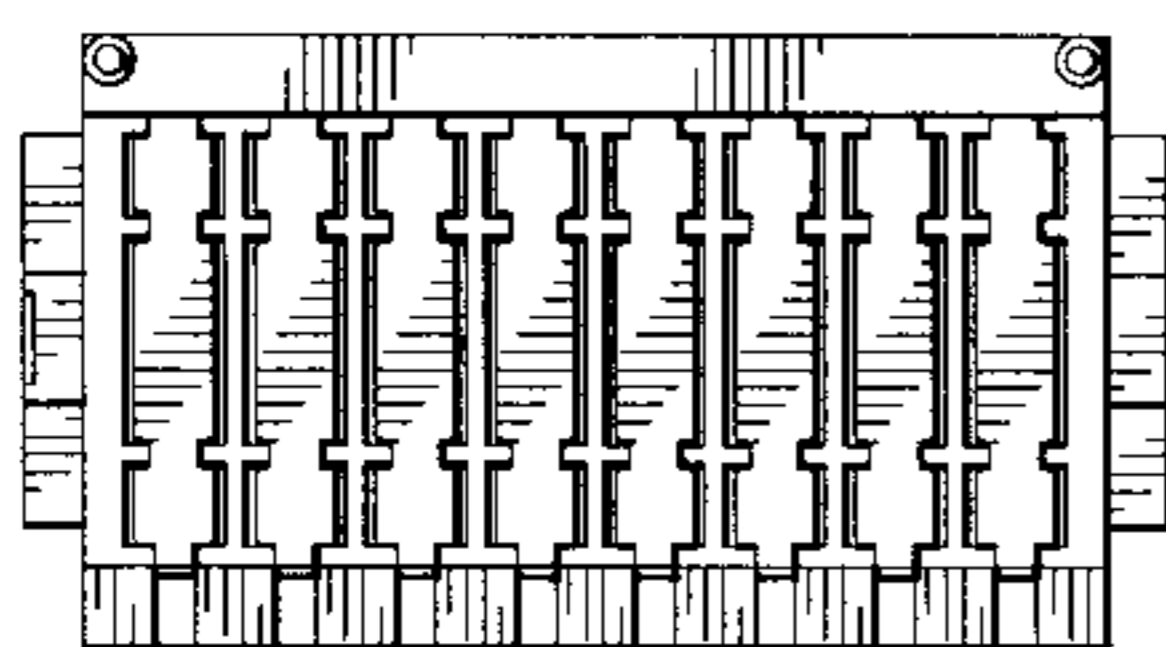

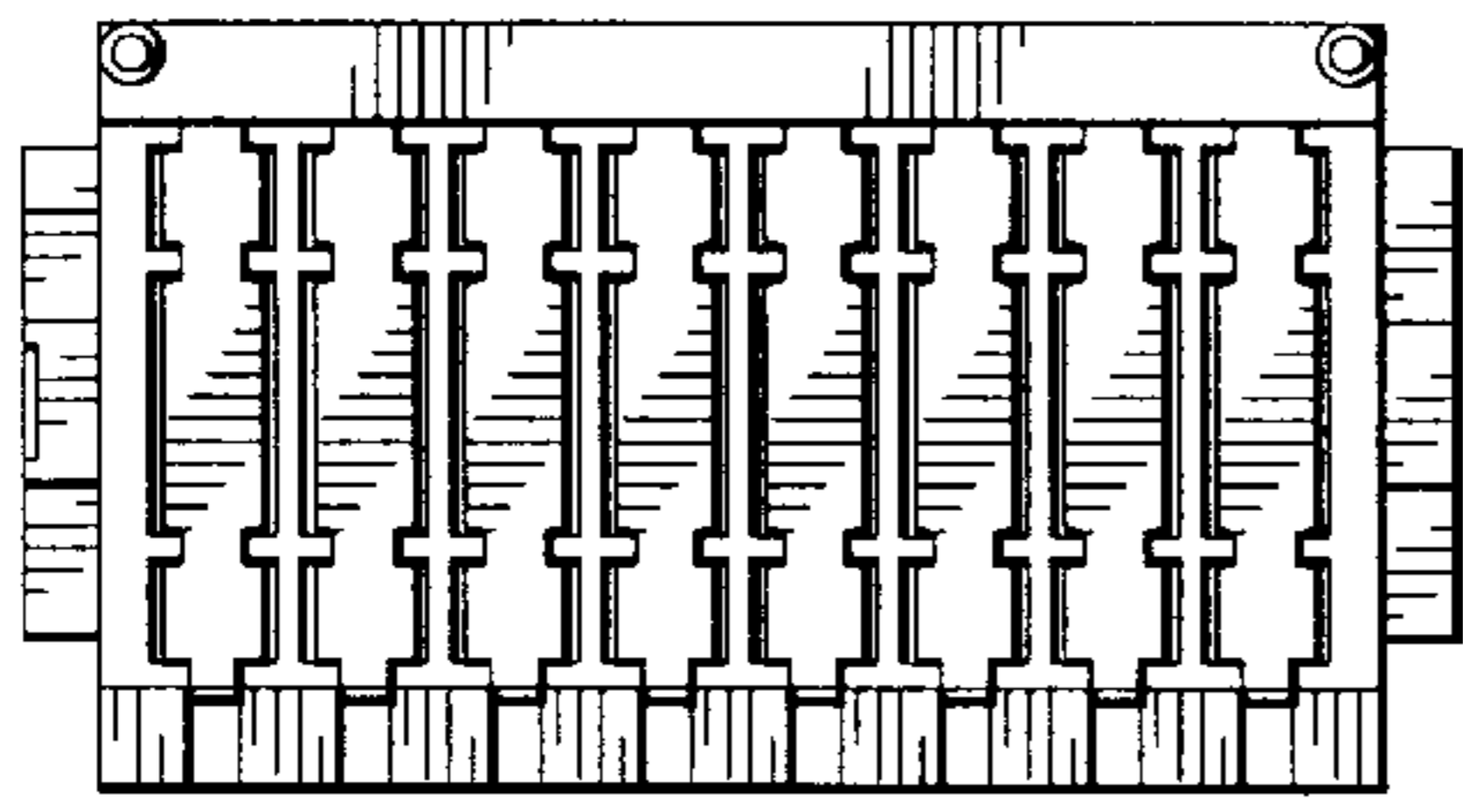

FIG 1

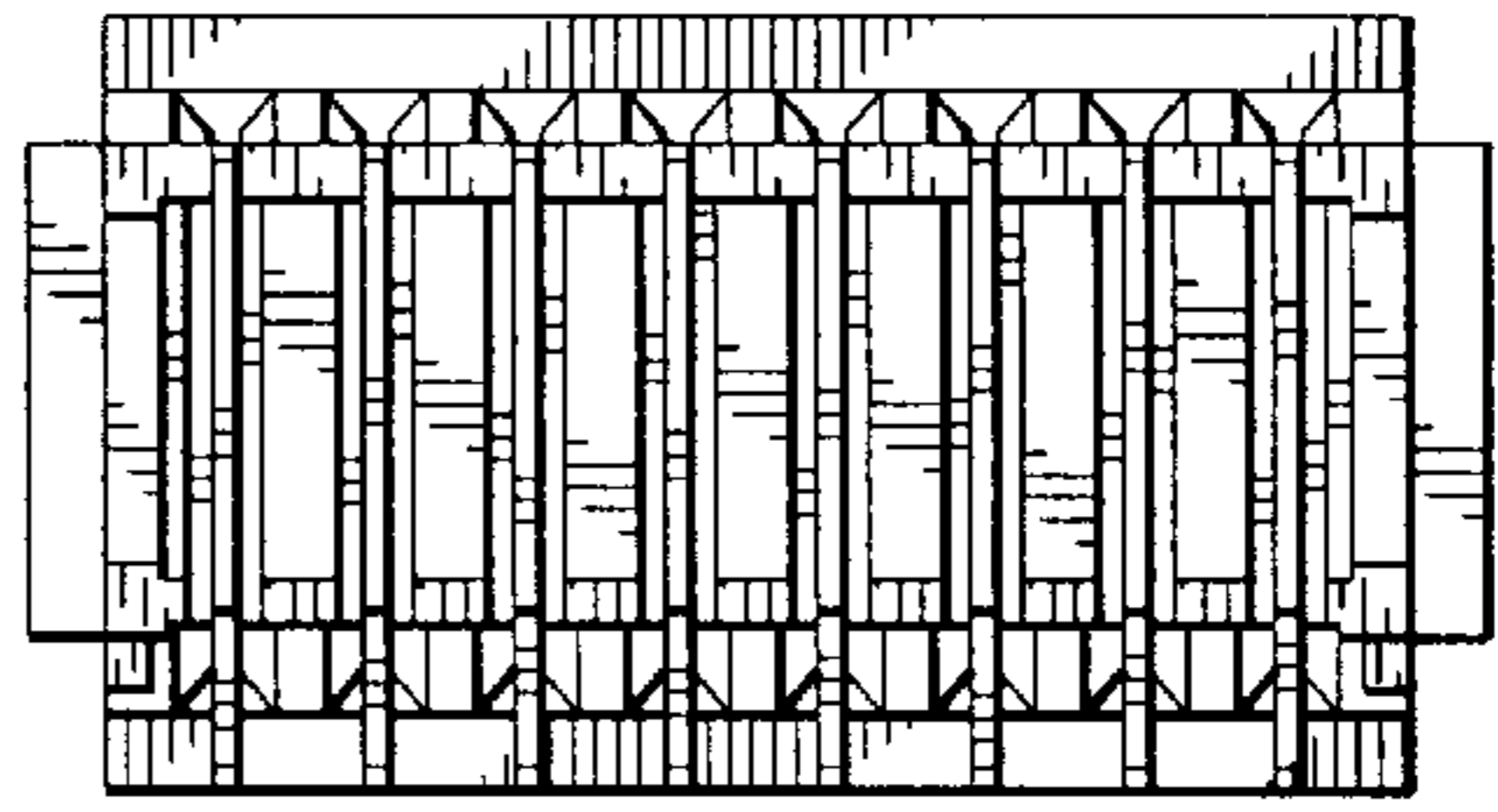

FIG 2

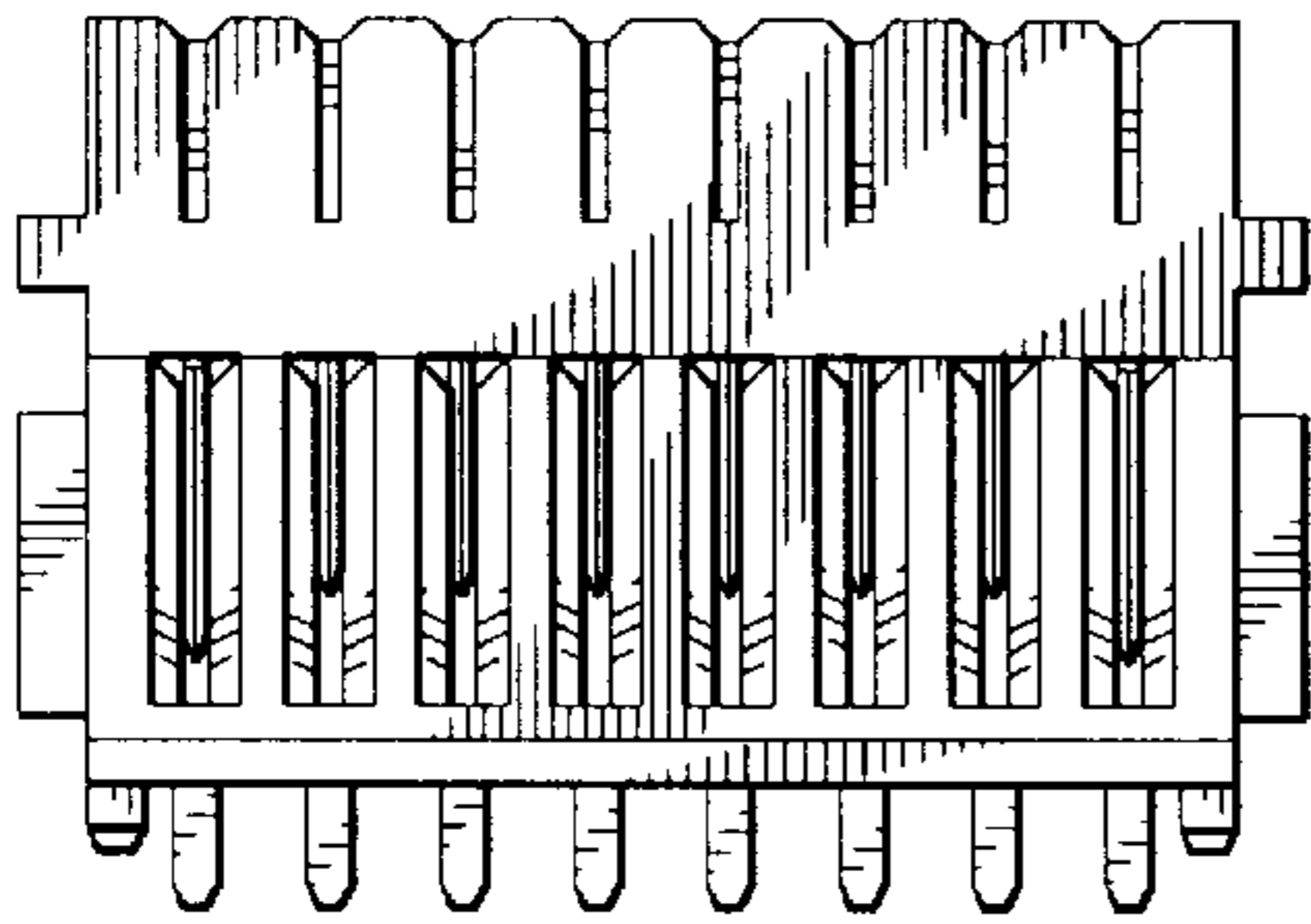

FIG 3

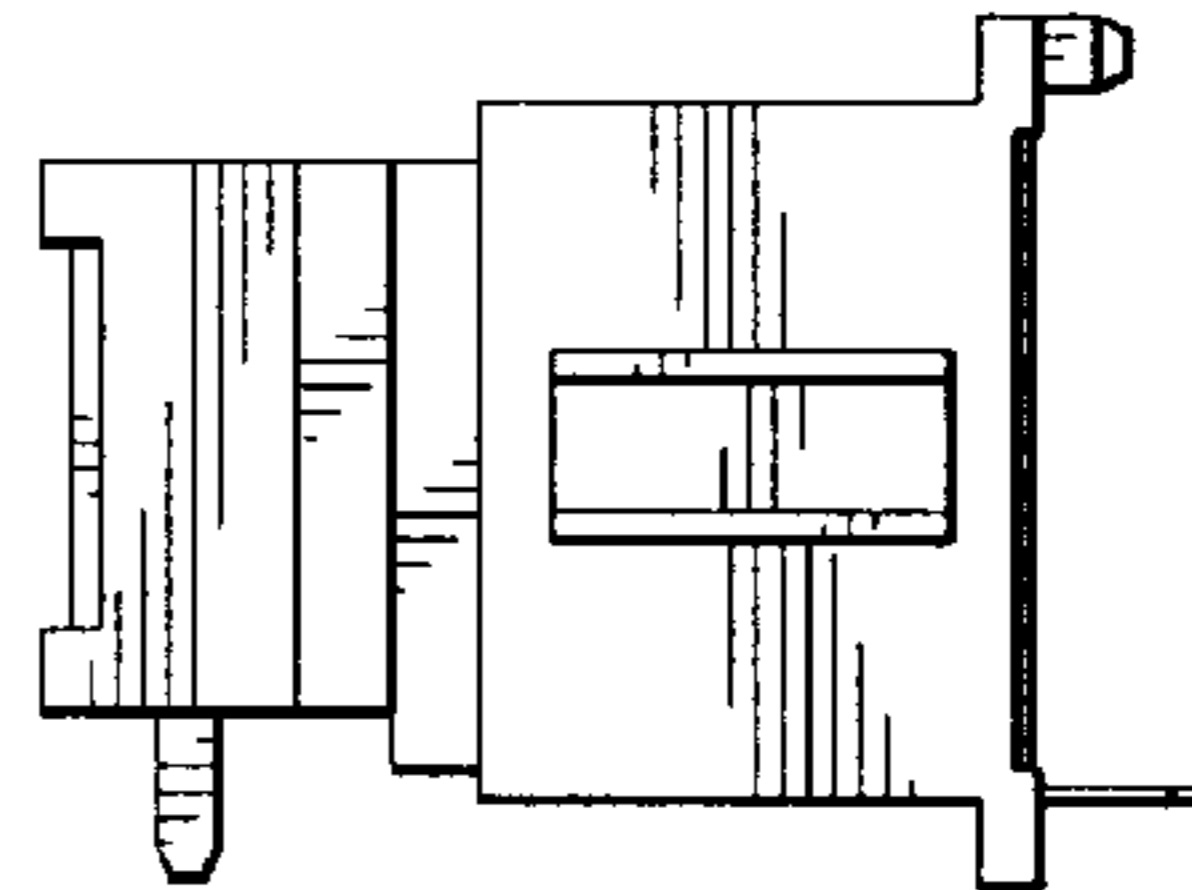

FIG 4

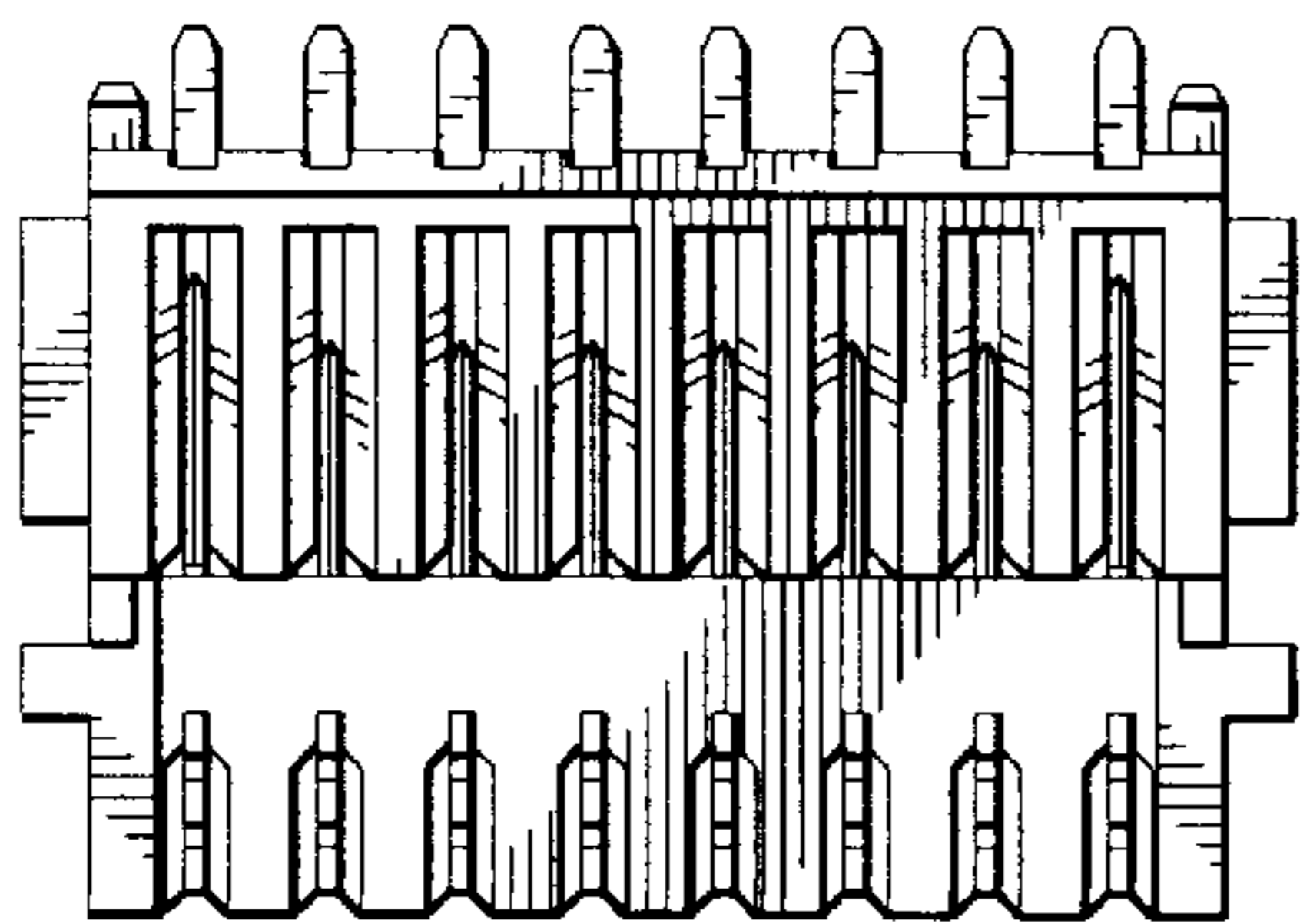

FIG 5

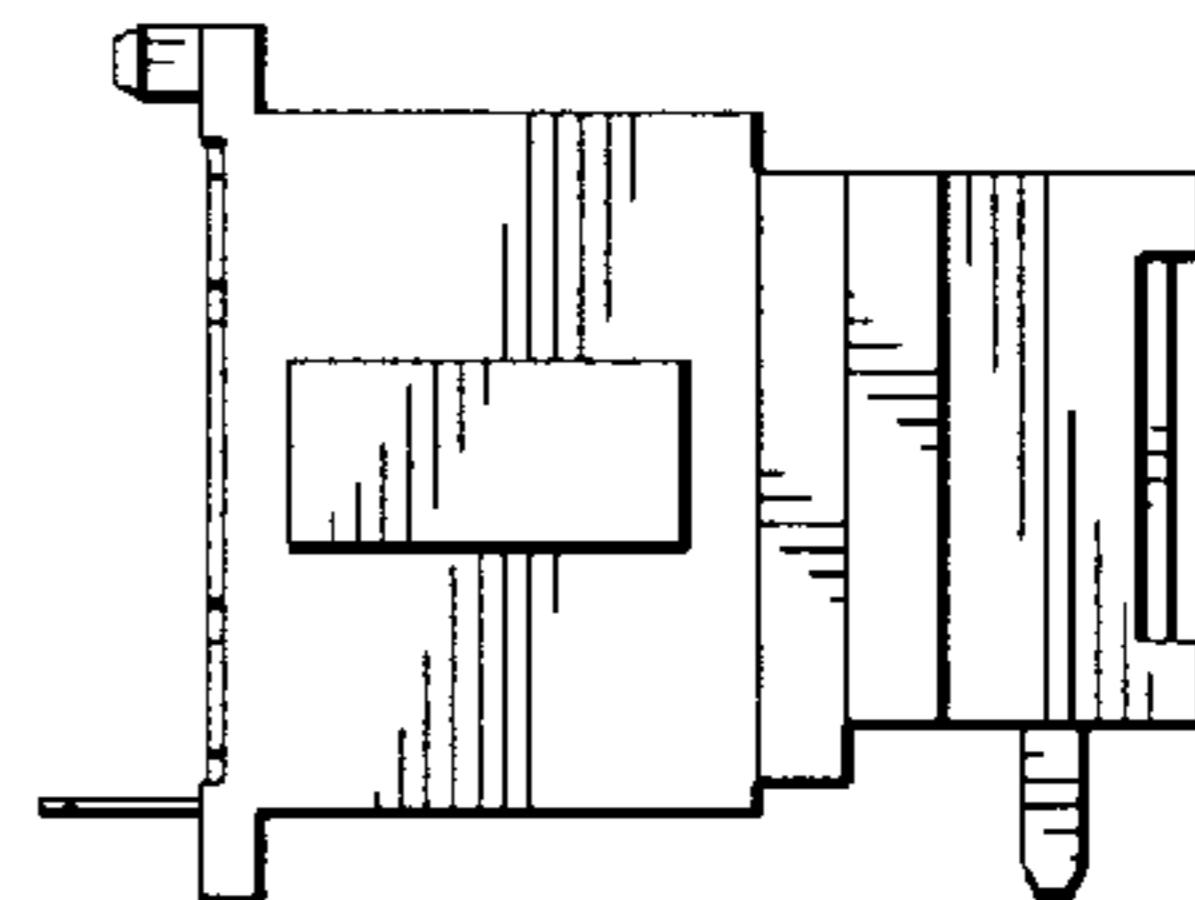

FIG 6

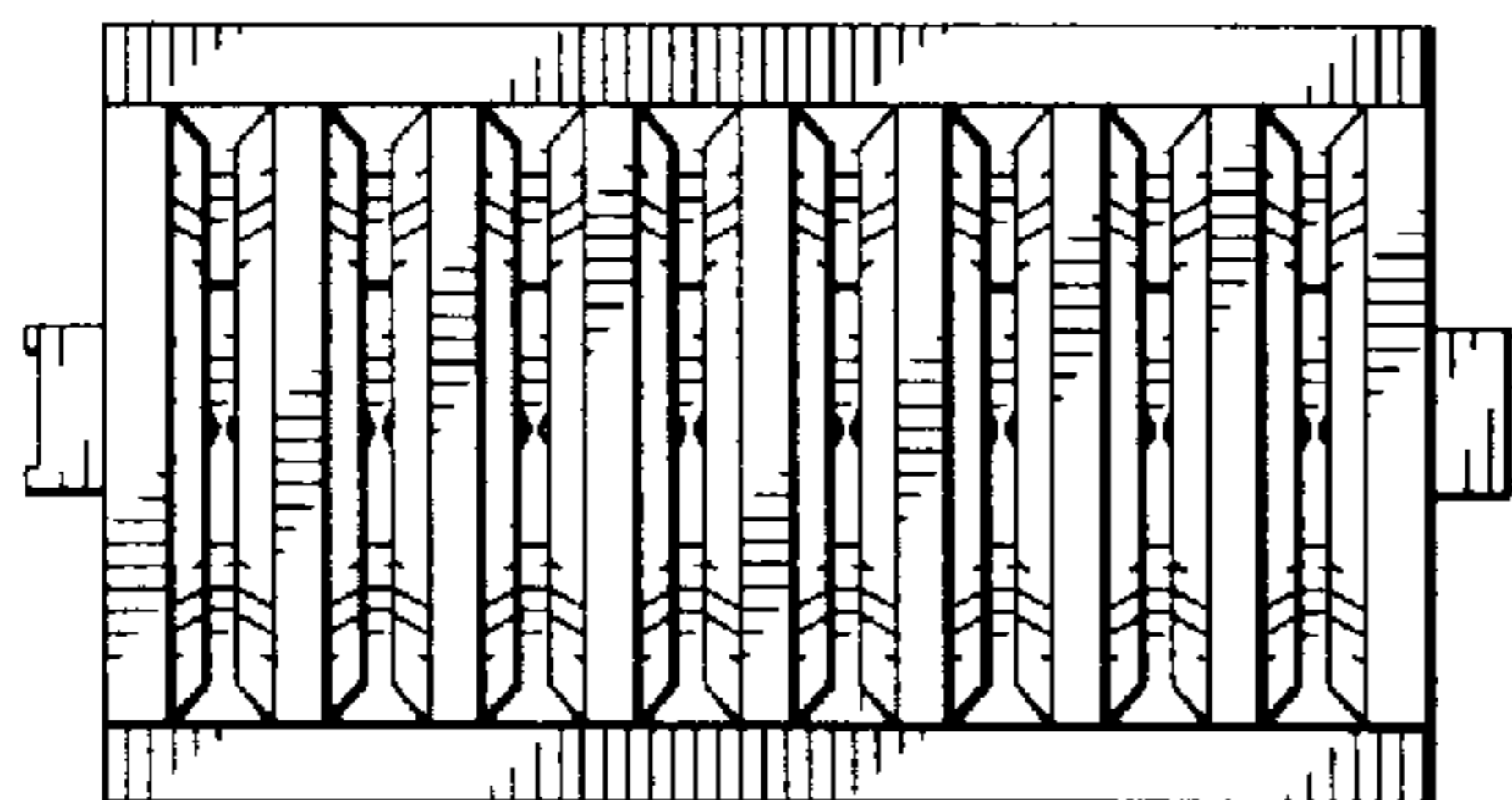

FIG 7

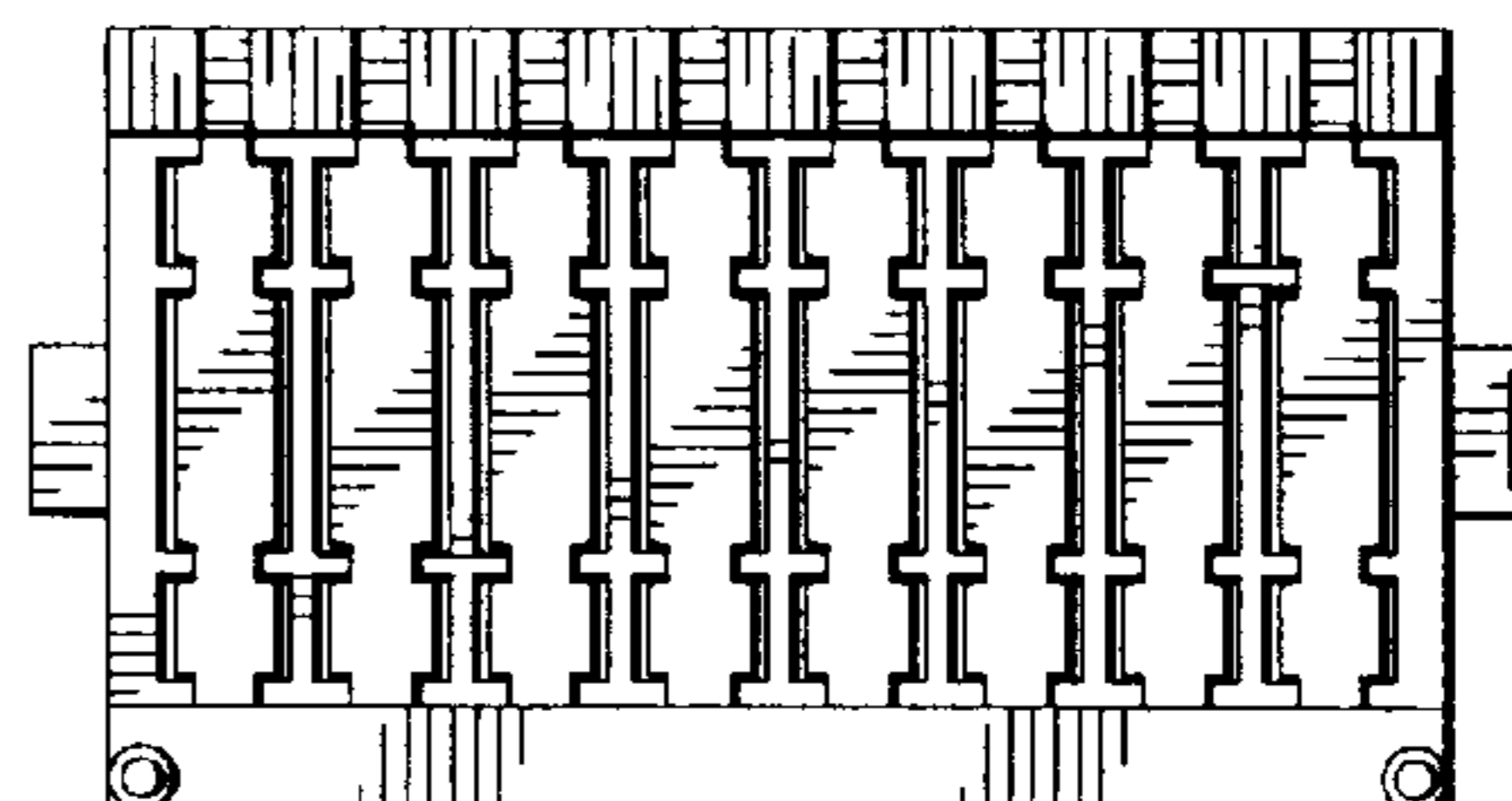

FIG 8

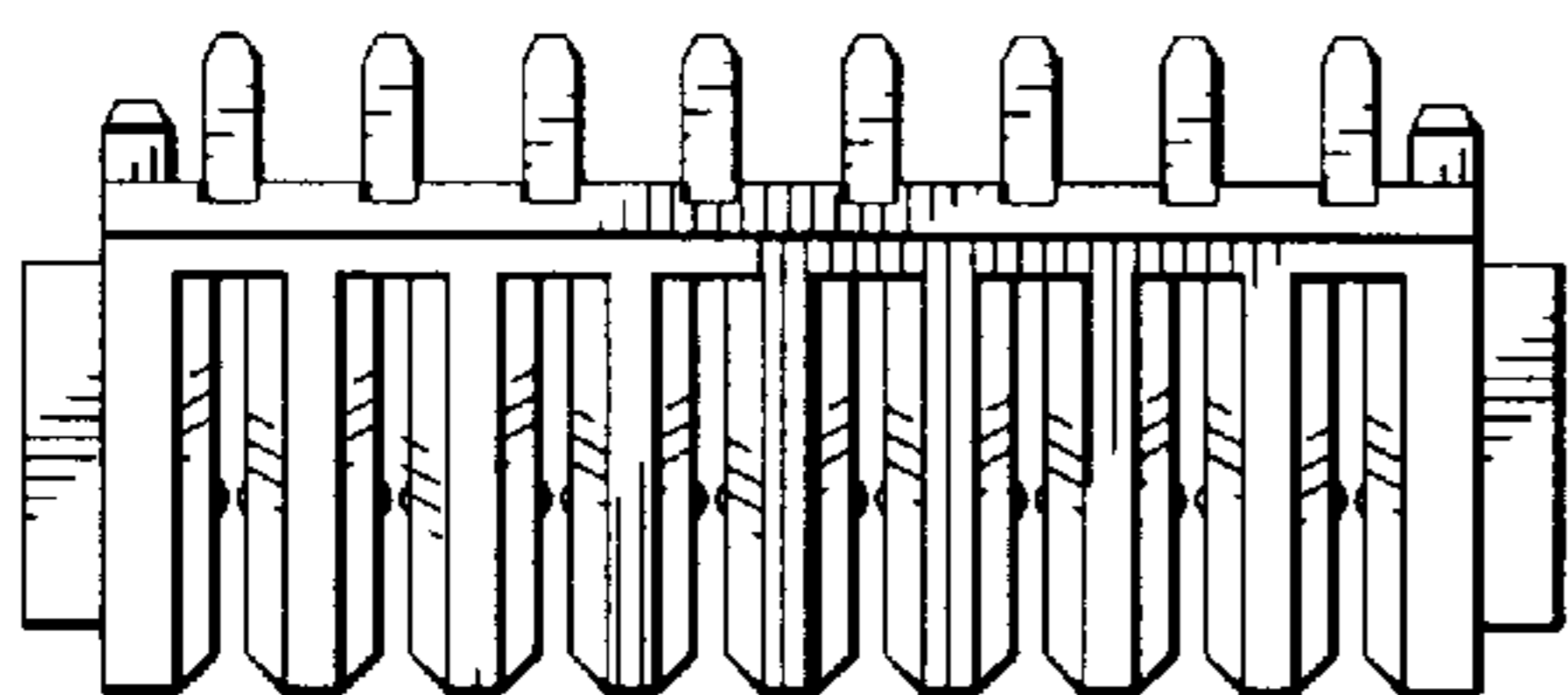

FIG 9

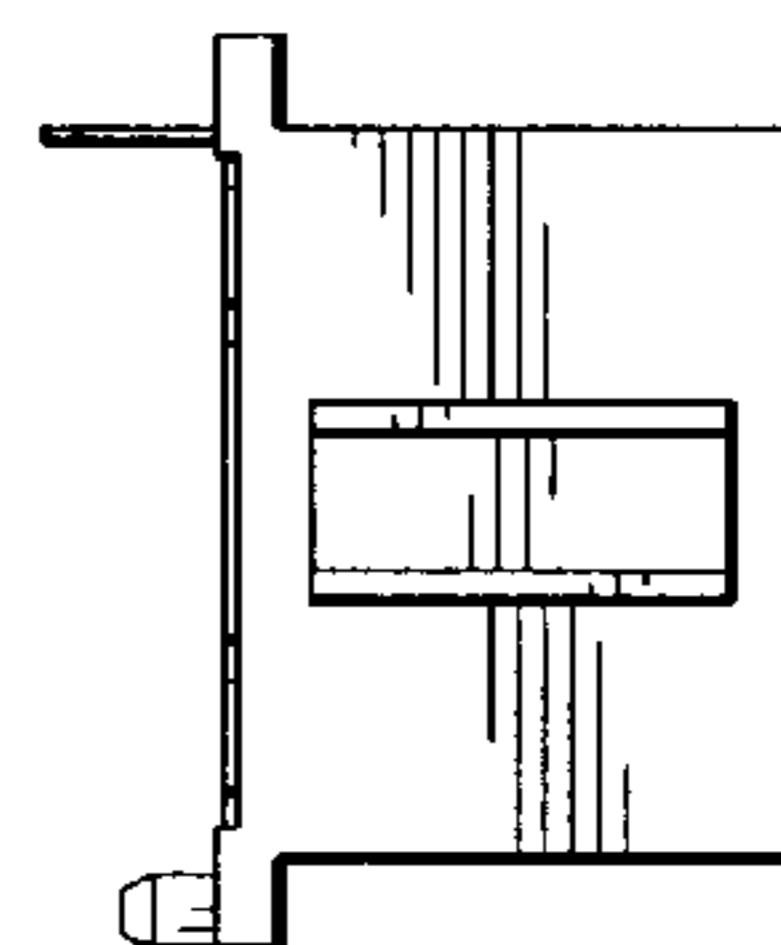

FIG 10

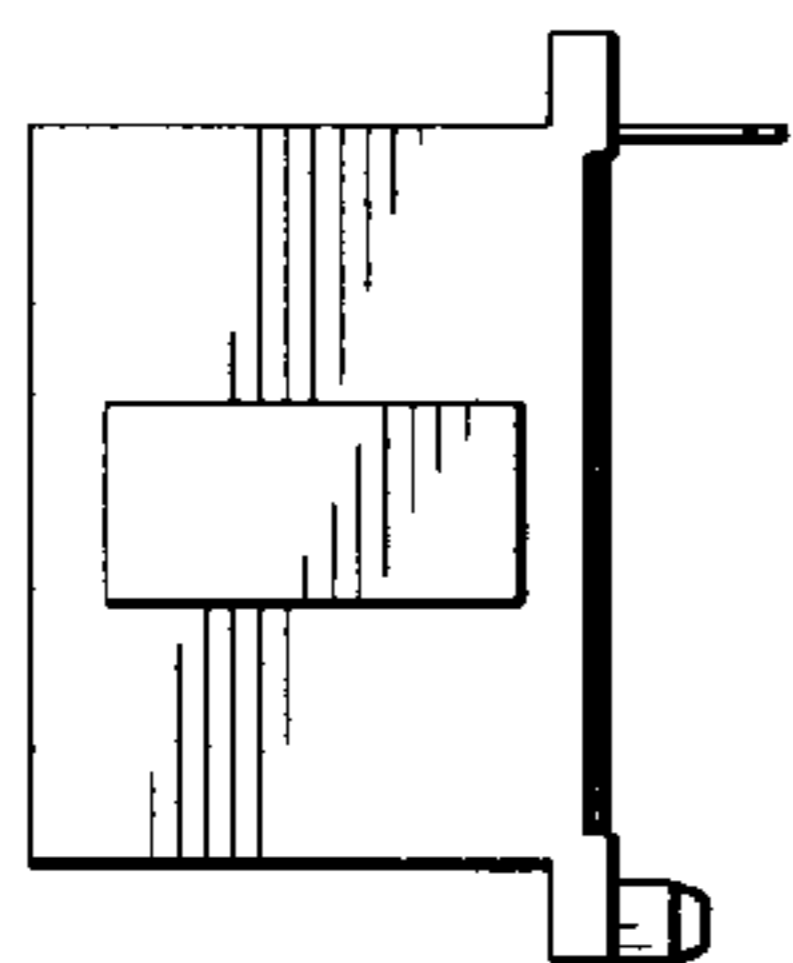

FIG 11

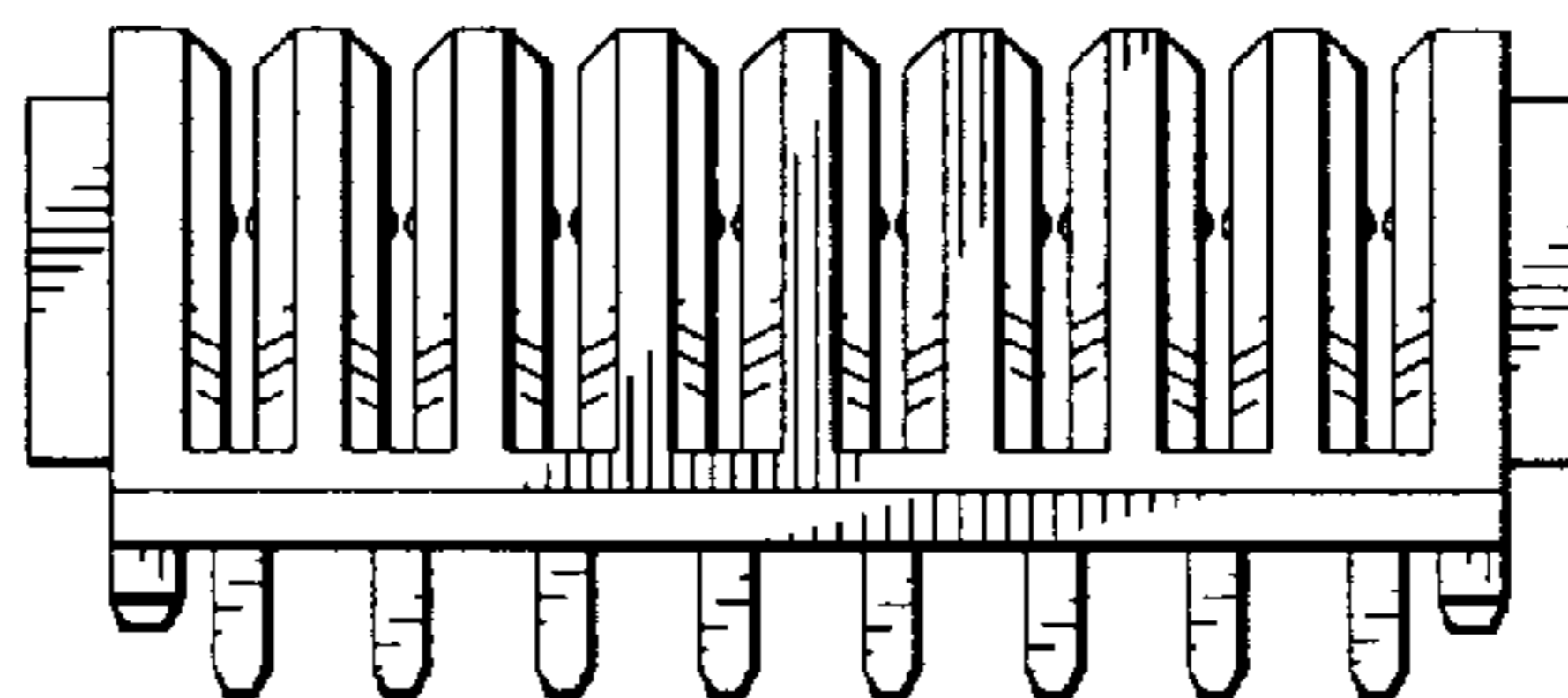

FIG 12

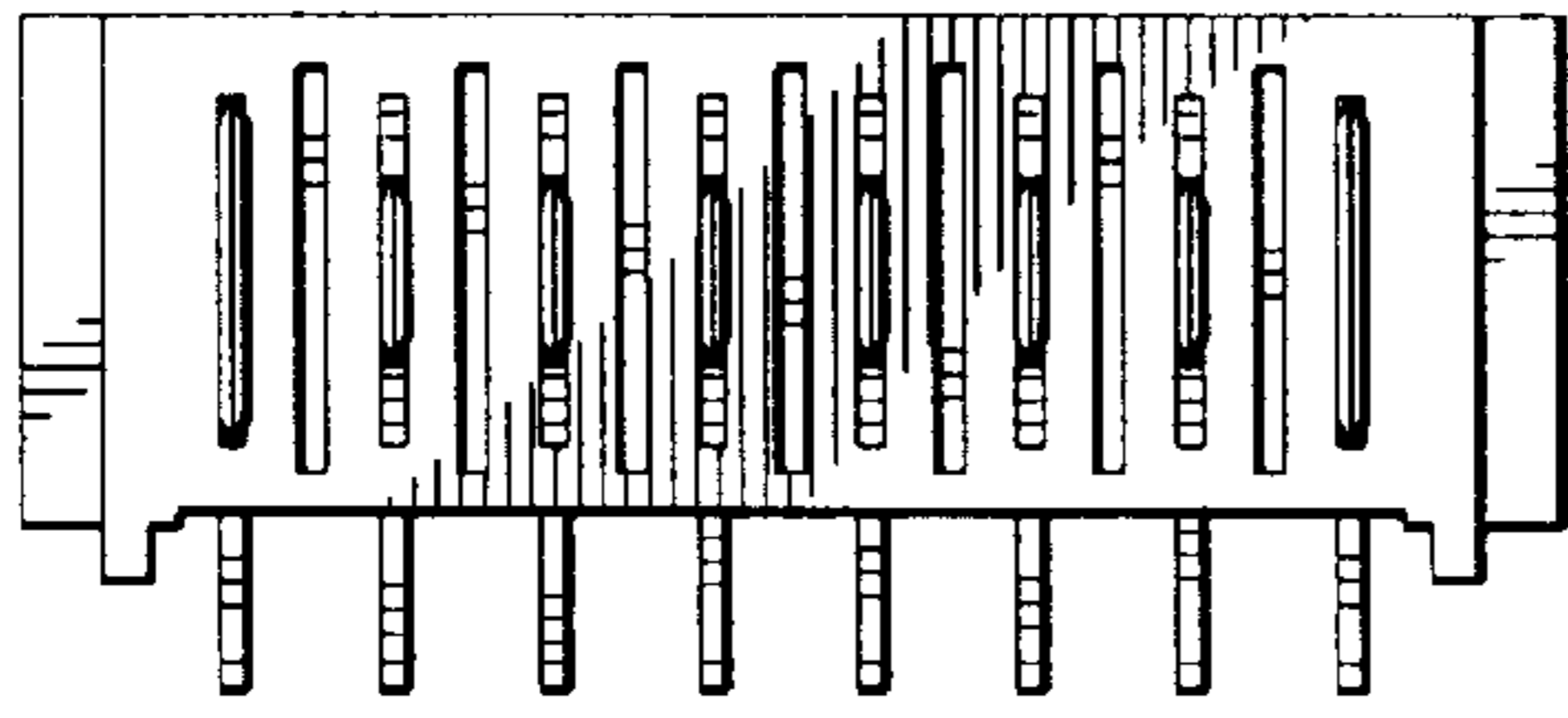

FIG 13

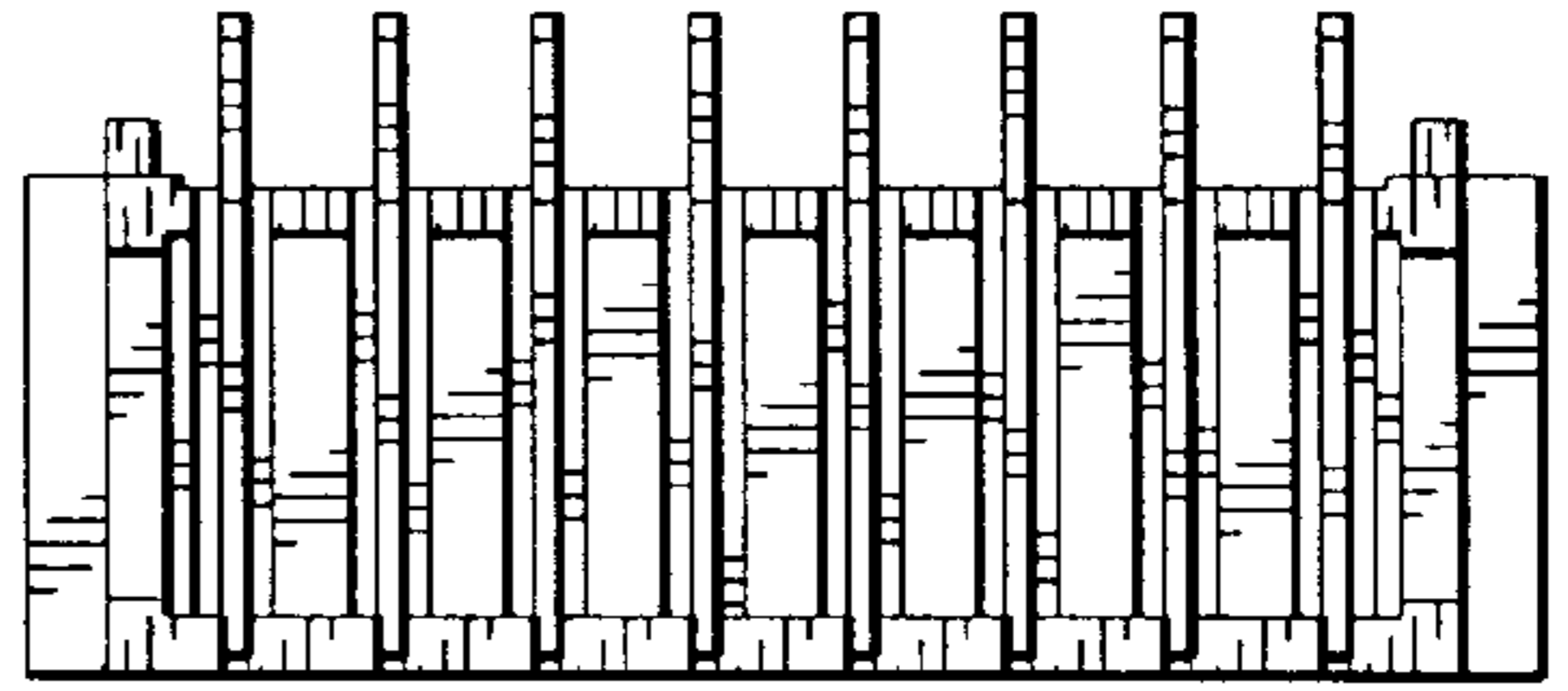

FIG 14

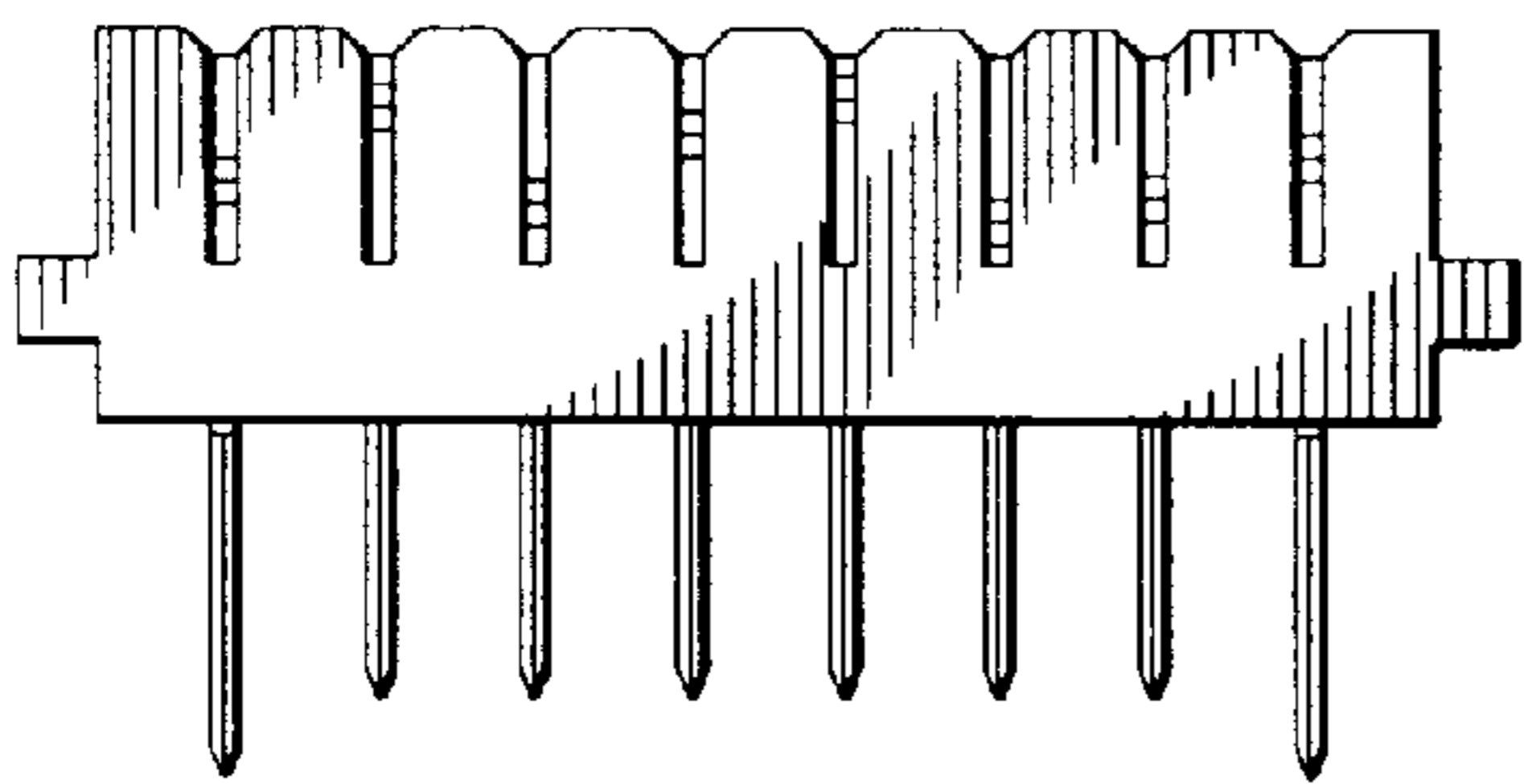

FIG 15

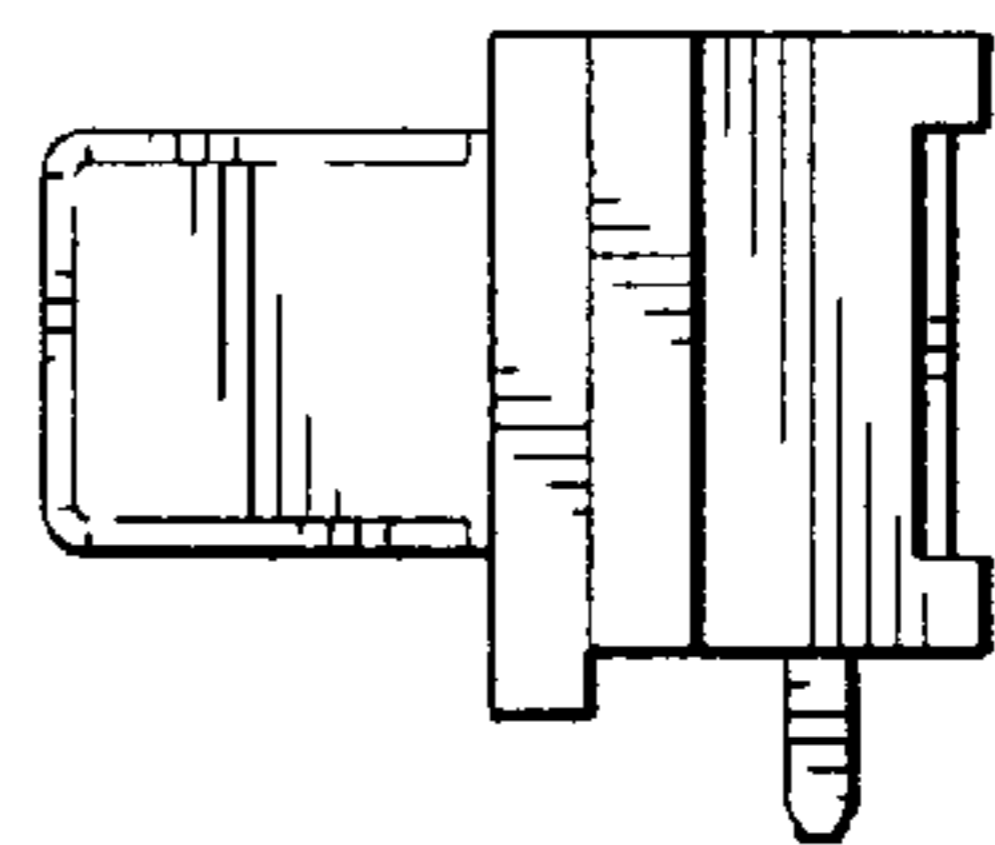

FIG 16

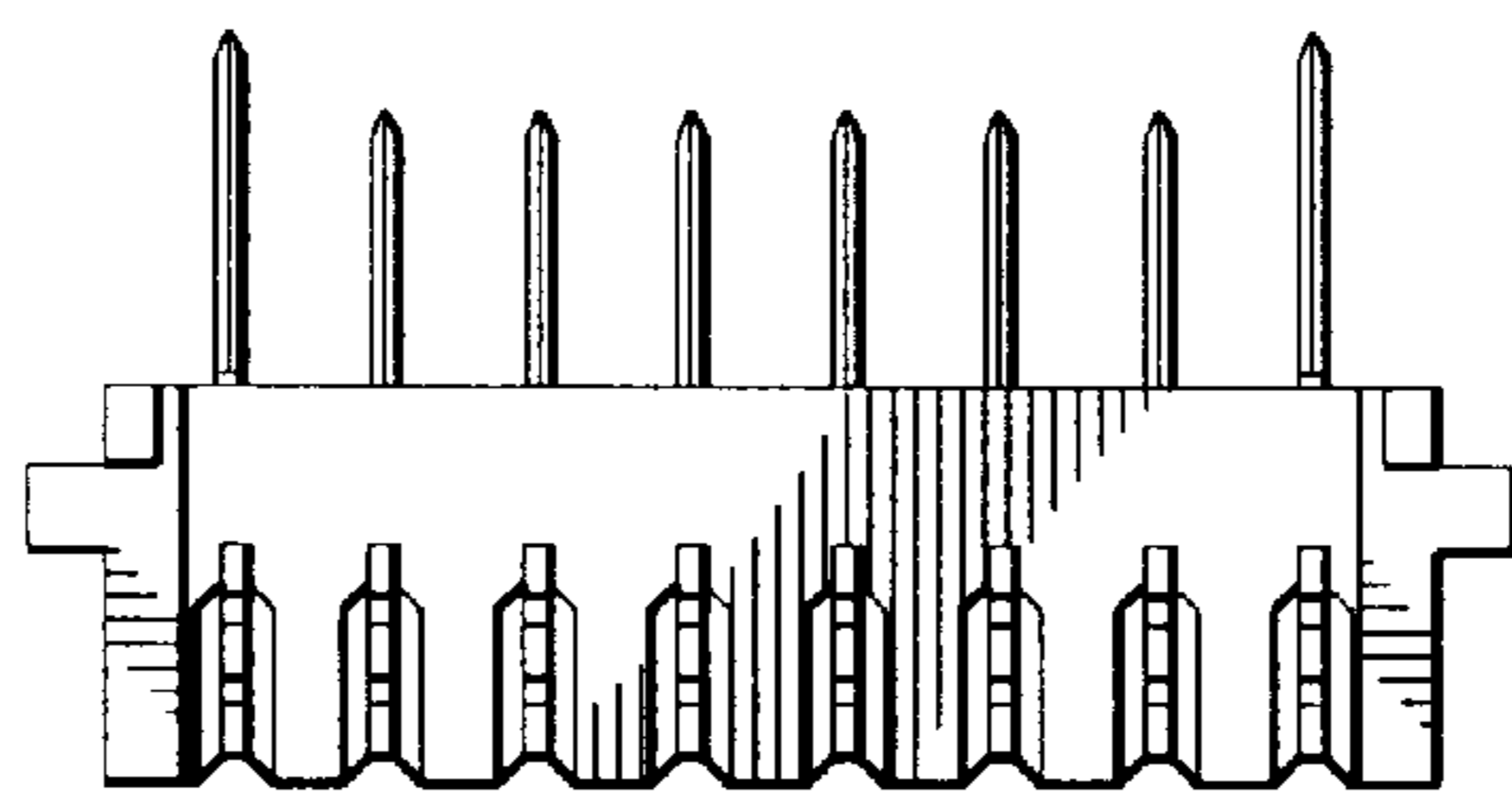

FIG 17

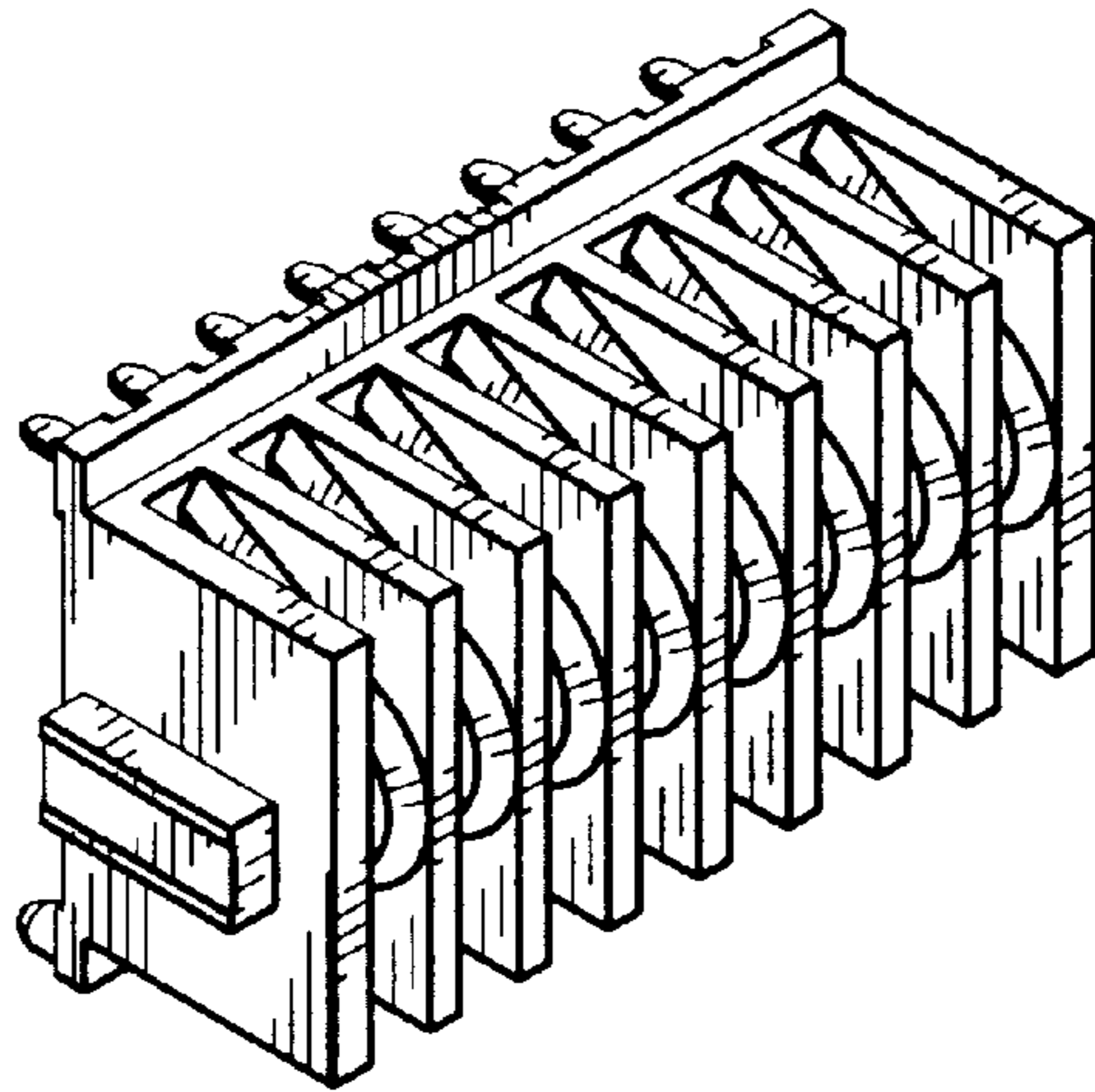

FIG 18

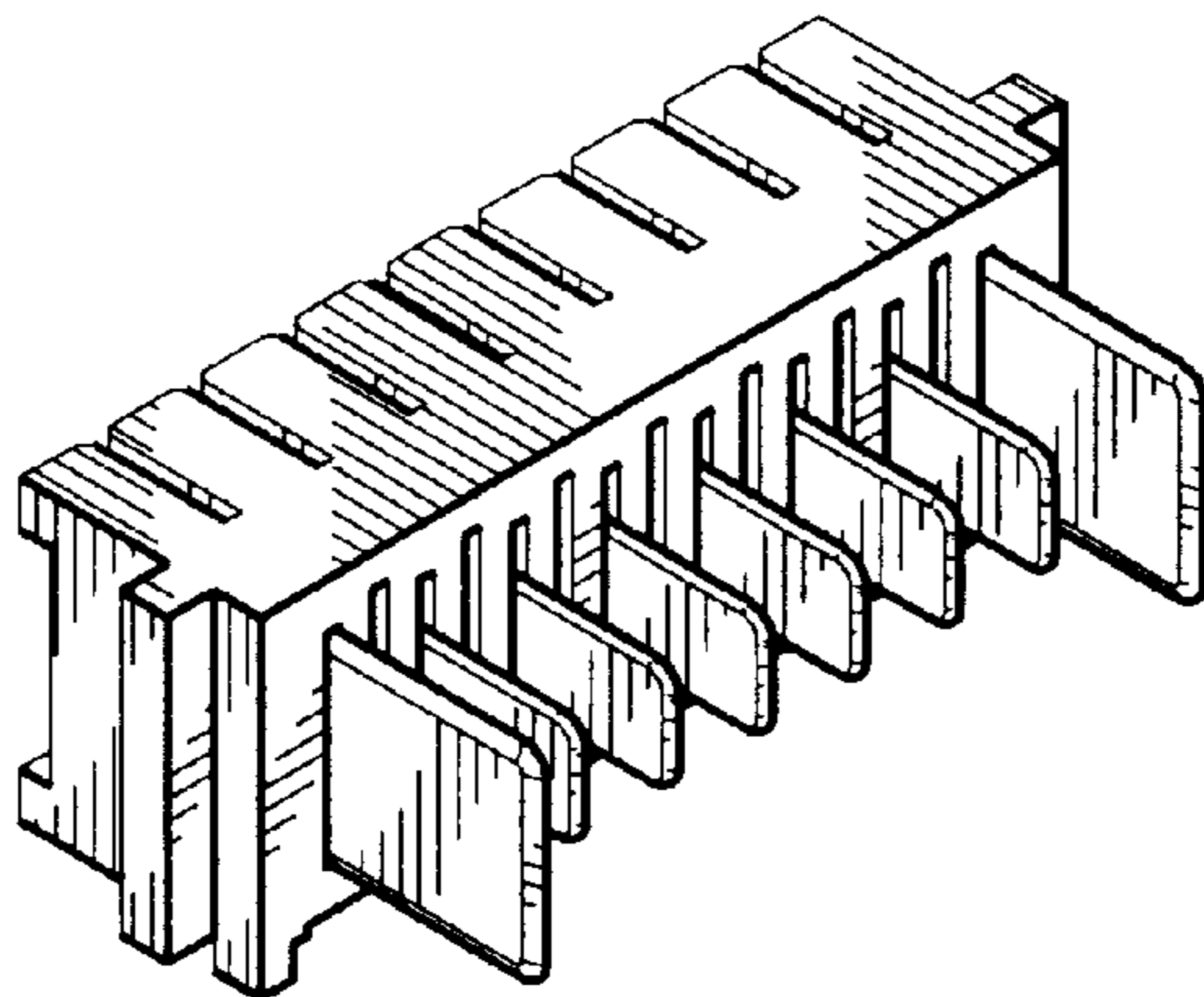

FIG 19