



US00D418104S

United States Patent [19]

Bove

[11] **Patent Number: Des. 418,104**

[45] **Date of Patent: ** Dec. 28, 1999**

[54] **BOAT HULL**

D. 355,881 2/1995 Carlson D12/314
D. 400,156 10/1998 Duvenage et al. D12/312

[76] Inventor: **Vittorio Bove**, 7 Redrock, Laguna Niguel, Calif. 92677

Primary Examiner—Kay H. Chin

[**] Term: **14 Years**

[57] **CLAIM**

The ornamental design for a boat hull, as shown.

[21] Appl. No.: **29/093,277**

DESCRIPTION

[22] Filed: **Sep. 8, 1998**

[51] **LOC (6) Cl.** **12-06**

FIG. 1 is a front elevational view of the boat hull showing my new design;

[52] **U.S. Cl.** **D12/314; D12/300**

FIG. 2 is a rear elevational view thereof;

[58] **Field of Search** D12/300-318;
114/61, 288-291, 273

FIG. 3 is a left side elevational view thereof;

FIG. 4 is a right side elevational view thereof;

FIG. 5 is a top plan view thereof; and,

FIG. 6 is a bottom plan view thereof.

[56] **References Cited**

U.S. PATENT DOCUMENTS

D. 222,510 10/1971 Centaro D12/300

1 Claim, 3 Drawing Sheets

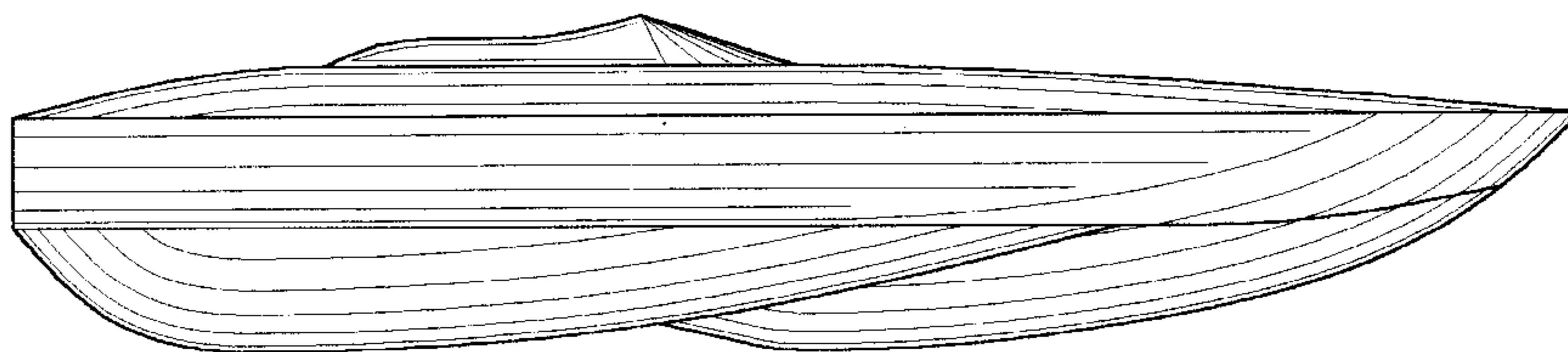
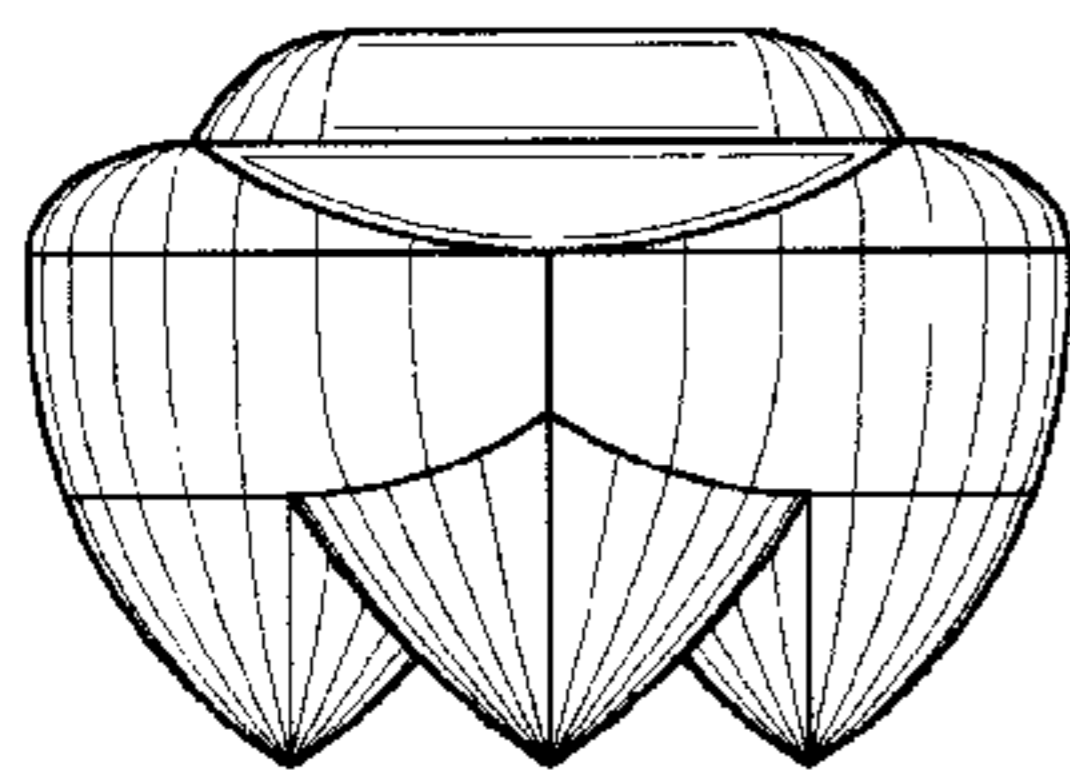

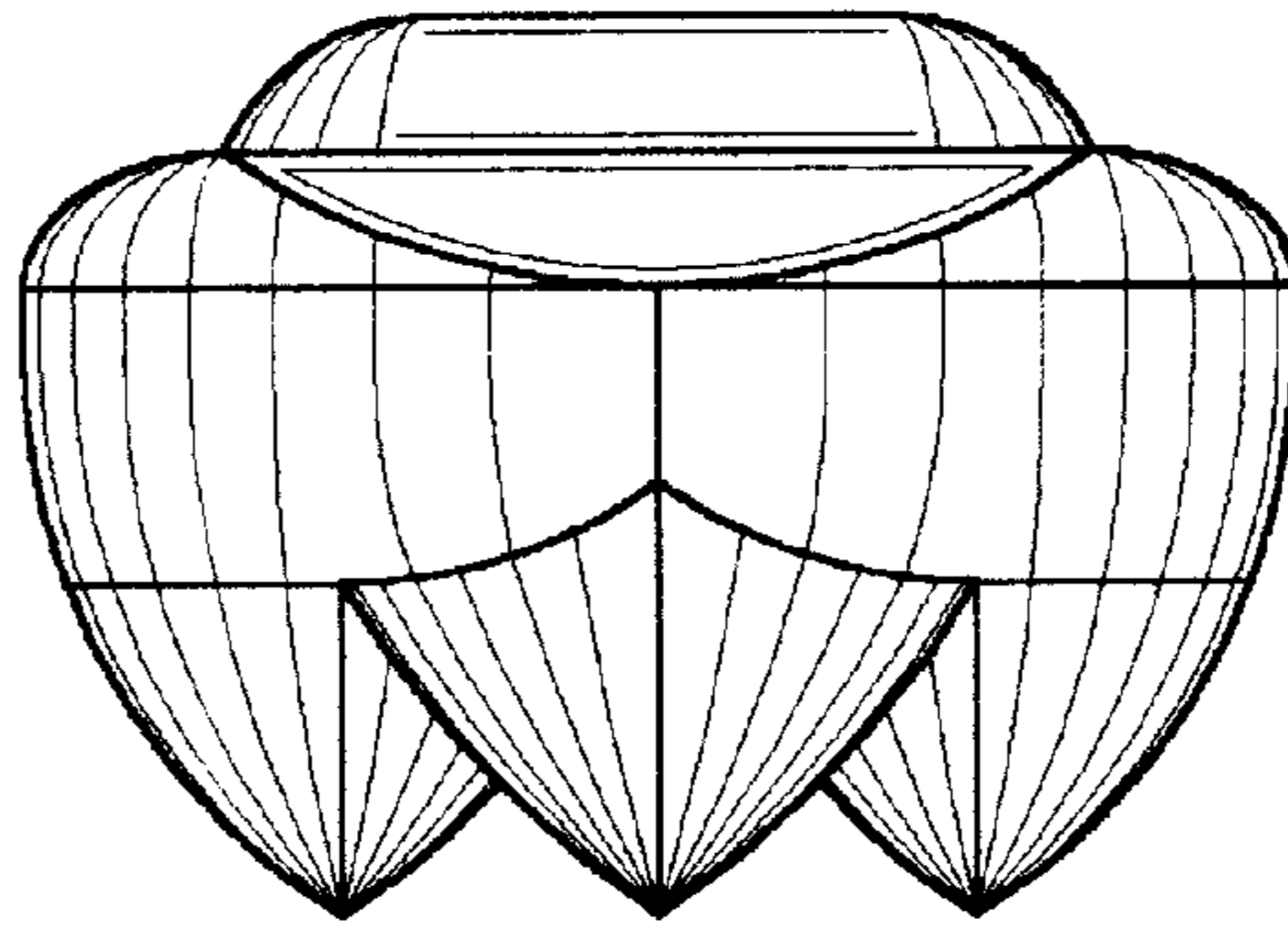

Fig. 1

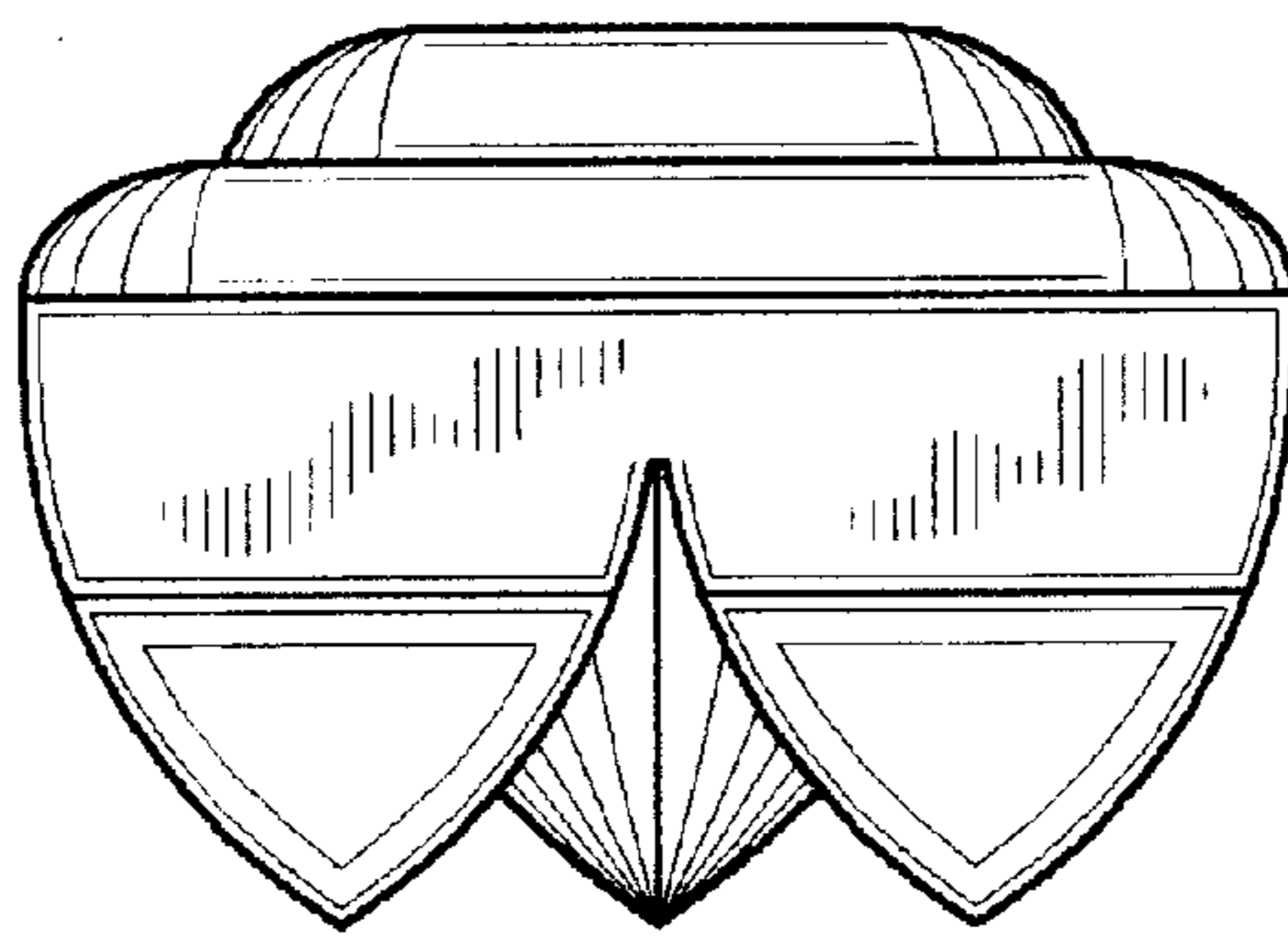

Fig. 2

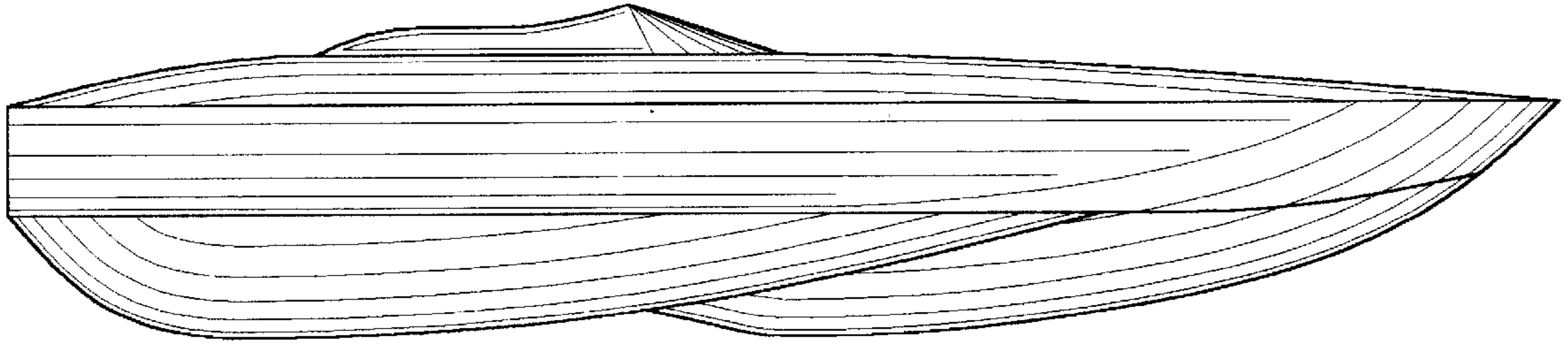

Fig. 3

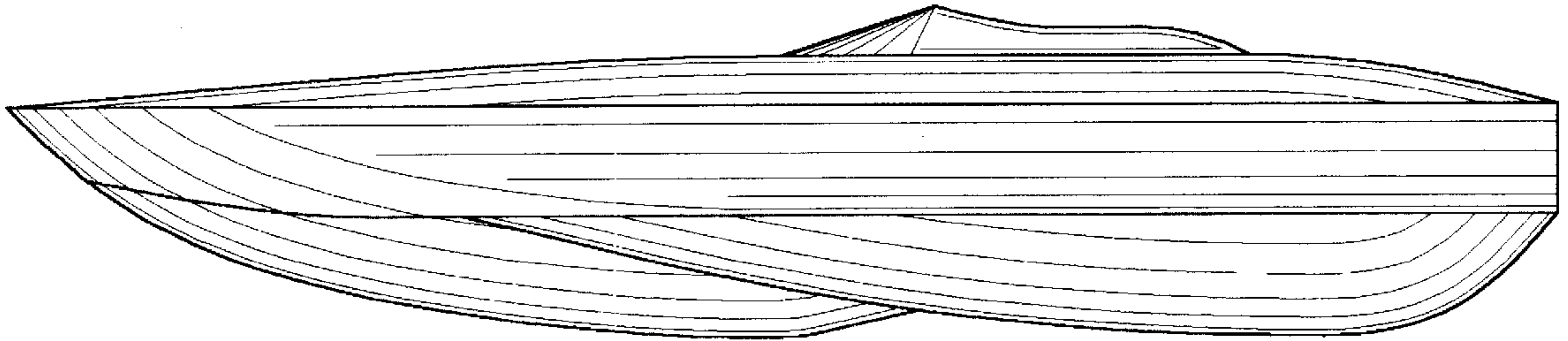

Fig. 4

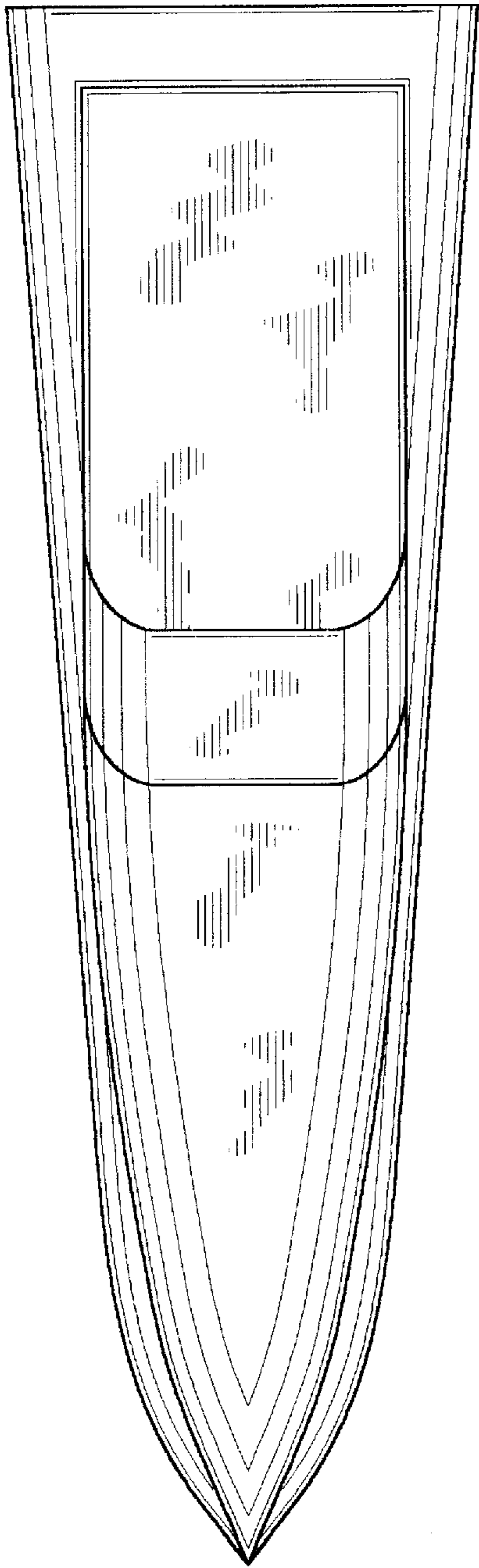

Fig. 5

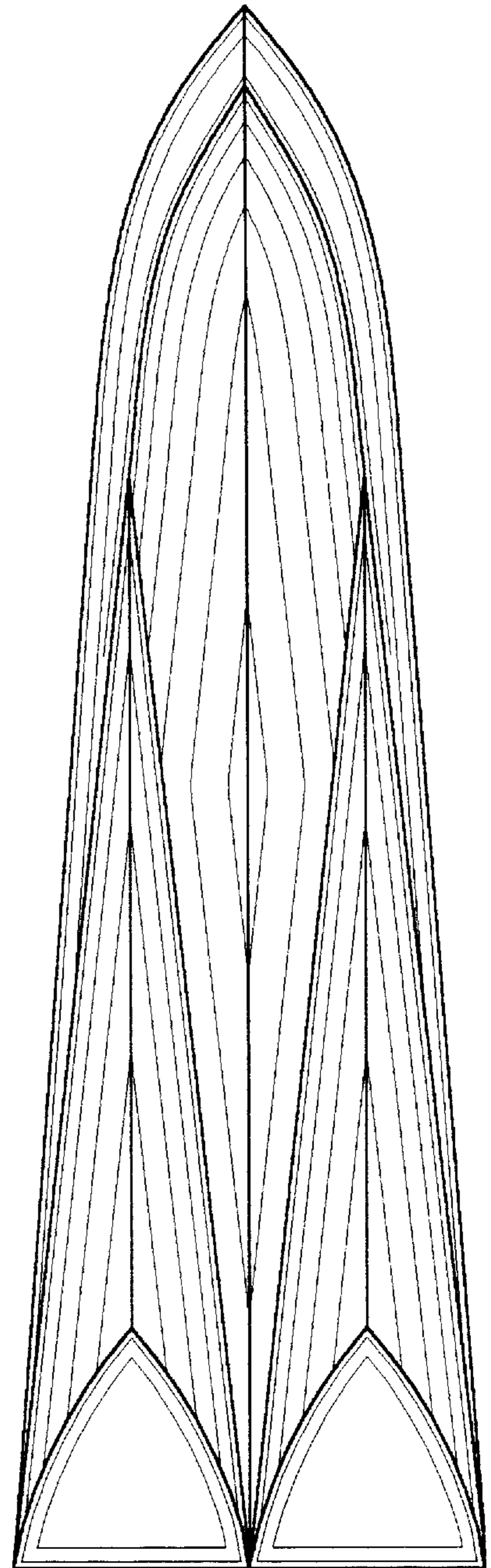

Fig. 6