



US00D418075S

**United States Patent** [19]  
**Kuntzman**

[11] **Patent Number: Des. 418,075**  
[45] **Date of Patent: \*\* Dec. 28, 1999**

[54] **VIBRATING MEDICATION REMINDER**

**DESCRIPTION**

[76] Inventor: **Julie Kuntzman**, R.R. #3 Box 161 201 Stone Ave., Watseka, Ill. 60970

[\*\*] Term: **14 Years**

[21] Appl. No.: **29/100,106**

[22] Filed: **Feb. 4, 1999**

[51] **LOC (6) Cl.** ..... **10-05**

[52] **U.S. Cl.** ..... **D10/104; D20/18**

[58] **Field of Search** ..... D10/104, 106; D20/18; 340/540, 571, 572, 573, 689; 40/107, 108, 109, 110

[56] **References Cited**

**U.S. PATENT DOCUMENTS**

D. 373,964	9/1996	Alexander	.....	D10/106
D. 391,183	2/1998	Campbell et al.	.....	D10/104
D. 406,542	3/1999	Mik	.....	D10/104
D. 407,986	4/1999	Jimbel	.....	D10/106

*Primary Examiner*—Marcus A. Jackson

[57] **CLAIM**

The ornamental design for a vibrating medication reminder, as shown and described.

FIG. 1 is a front elevational view of the vibrating medication reminder of the present invention;

FIG. 2 is a back elevational view of the vibrating medication reminder of FIG. 1;

FIG. 3 is a left side elevational view of the vibrating medication reminder of FIG. 1;

FIG. 4 is a right side elevational view of the vibrating medication reminder of FIG. 1;

FIG. 5 is a top plan view of the vibrating medication reminder of FIG. 1;

FIG. 6 is a bottom plan view of the vibrating medication reminder of FIG. 1; and,

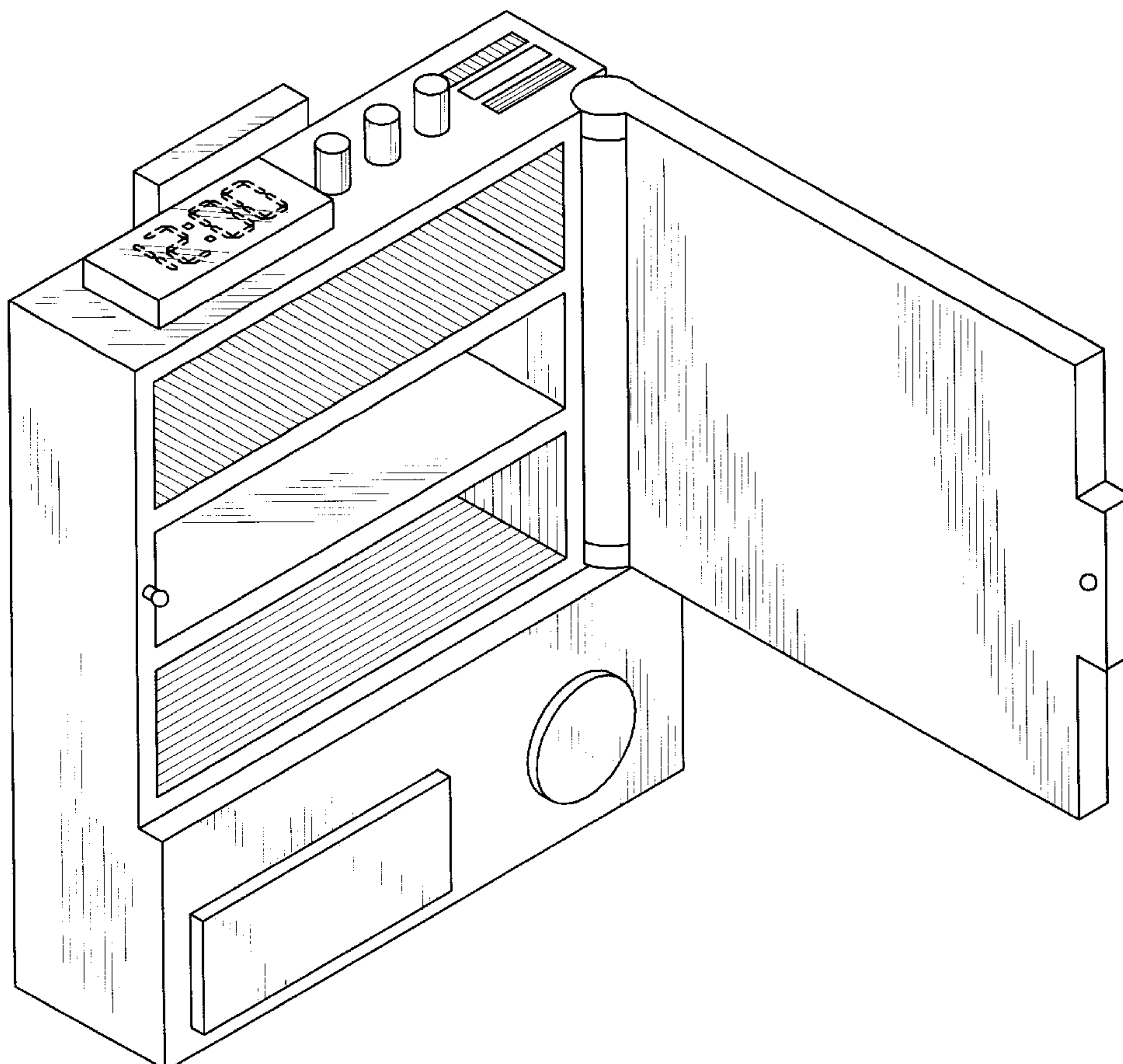
FIG. 7 is a top, front, left side elevational view of the vibrating medication reminder of FIG. 1 in an alternate position.

The vertical hatching shown in FIGS. 5 and 6 is indicative of the color red.

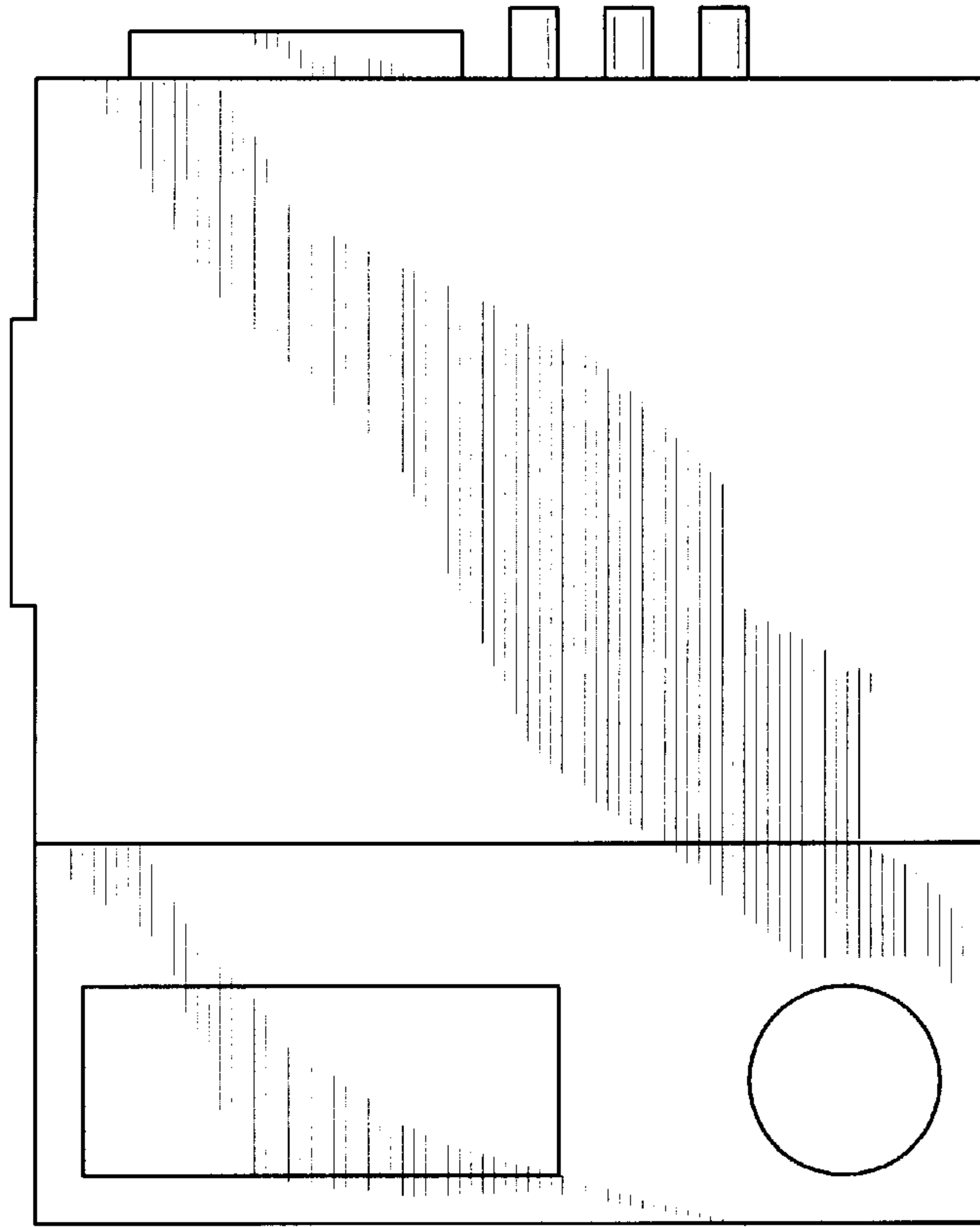
The horizontal hatching shown in FIGS. 5 and 6 is indicative of the color blue.

The broken lines showing numbers in FIG. 7 are for illustrative purposes only and form no part of the claimed design

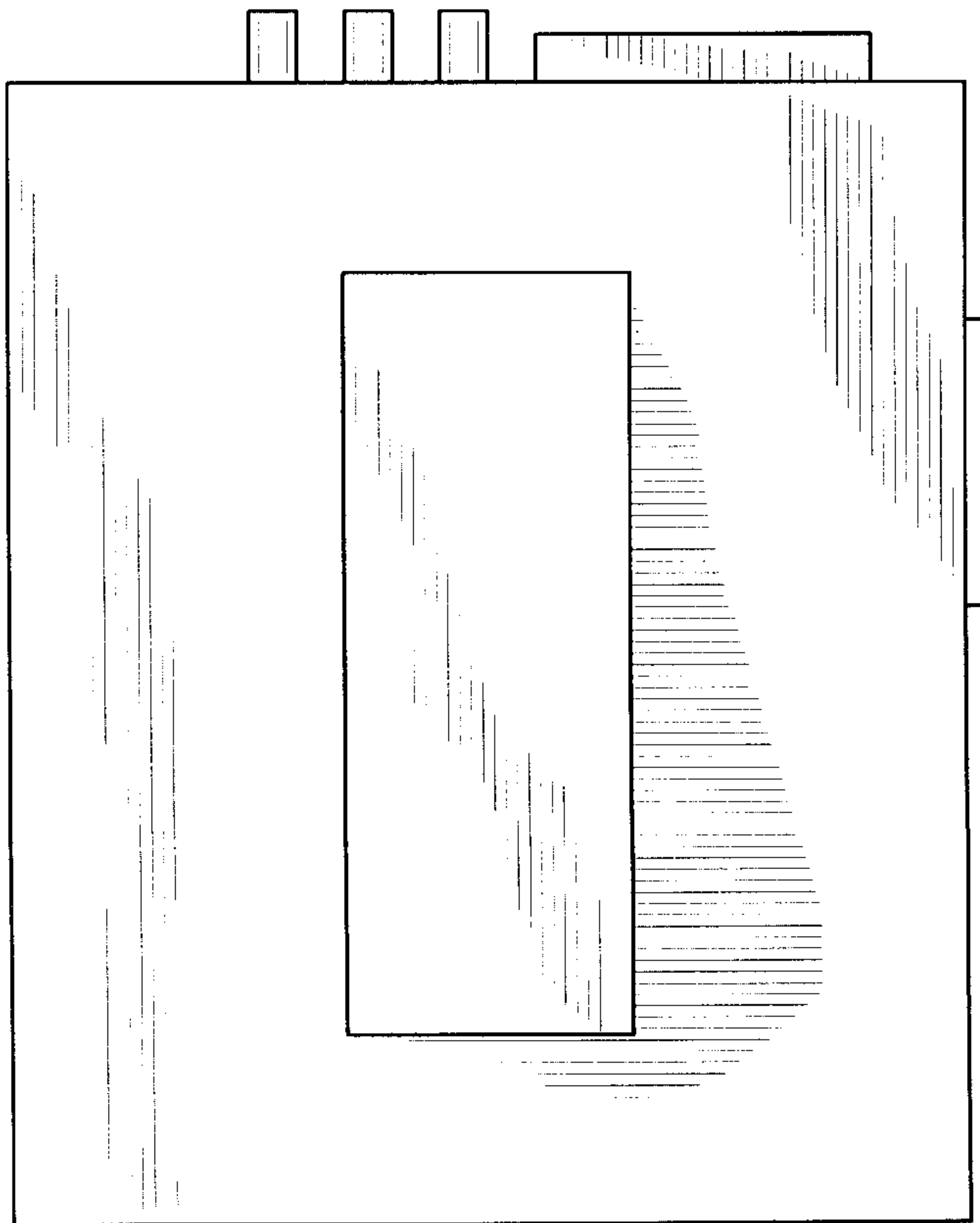
**1 Claim, 3 Drawing Sheets**

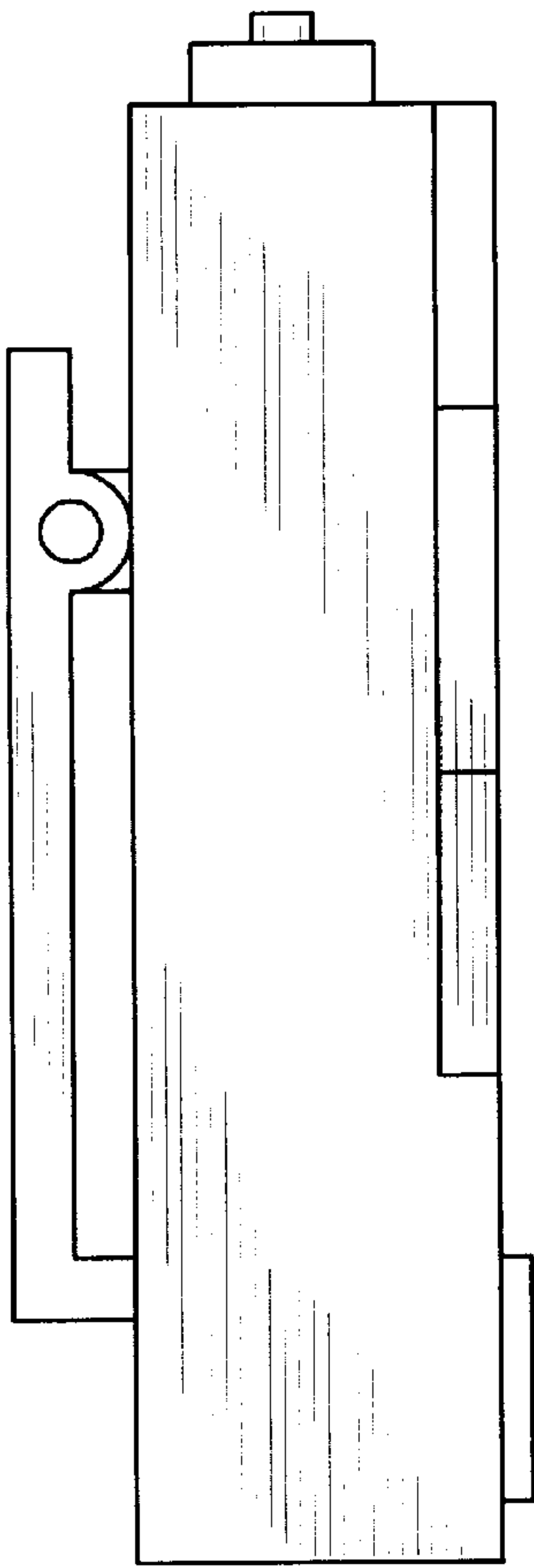


**FIG. 1**



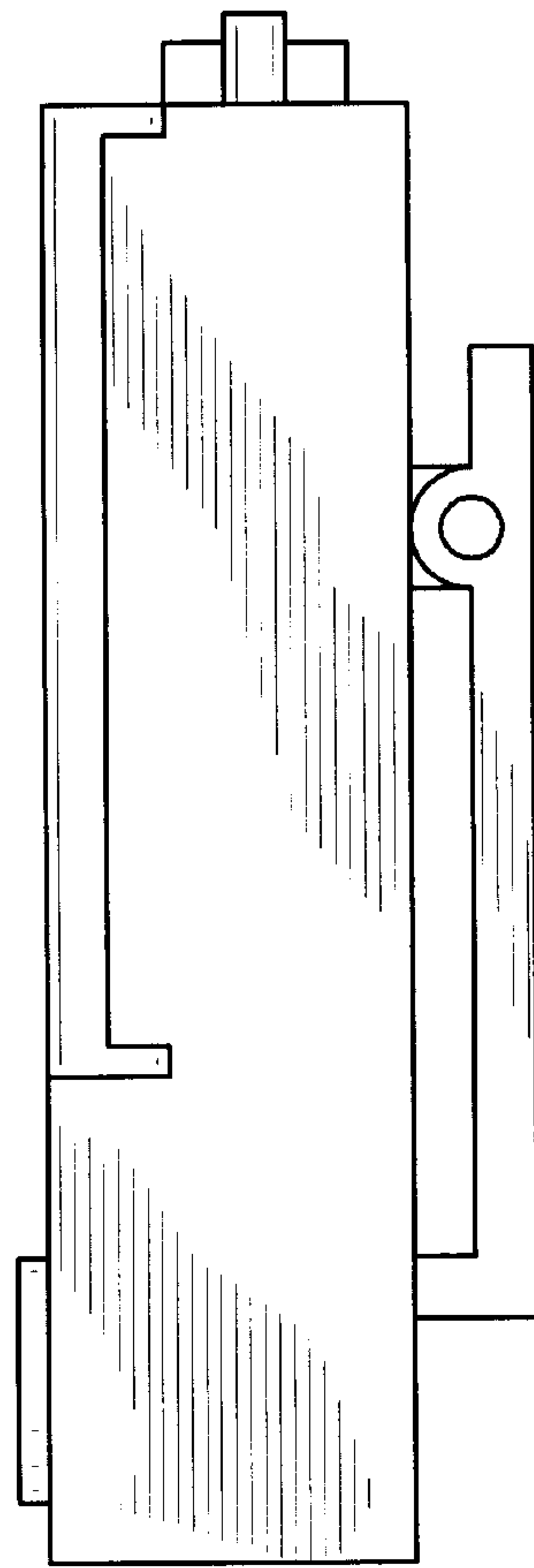
**FIG. 2**



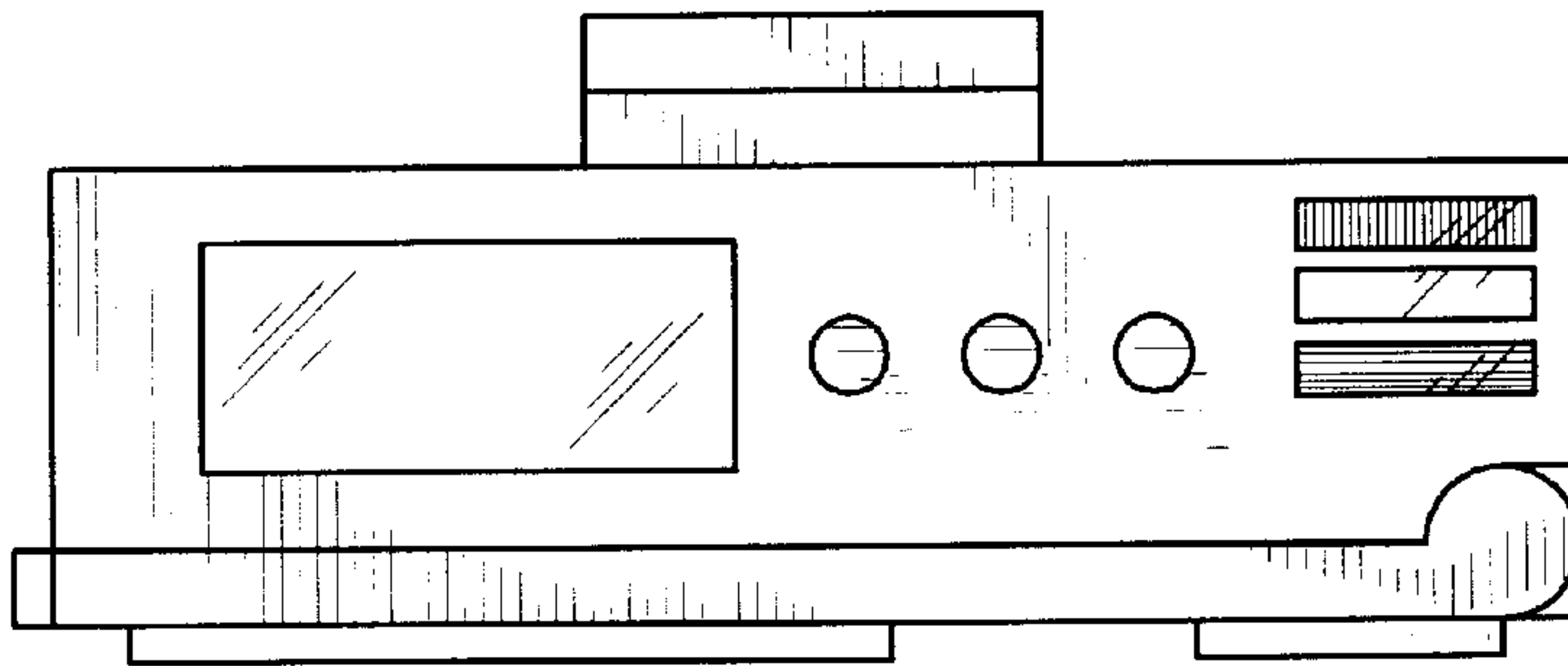


**FIG. 3**

**FIG. 5**



**FIG. 4**



**FIG. 6**

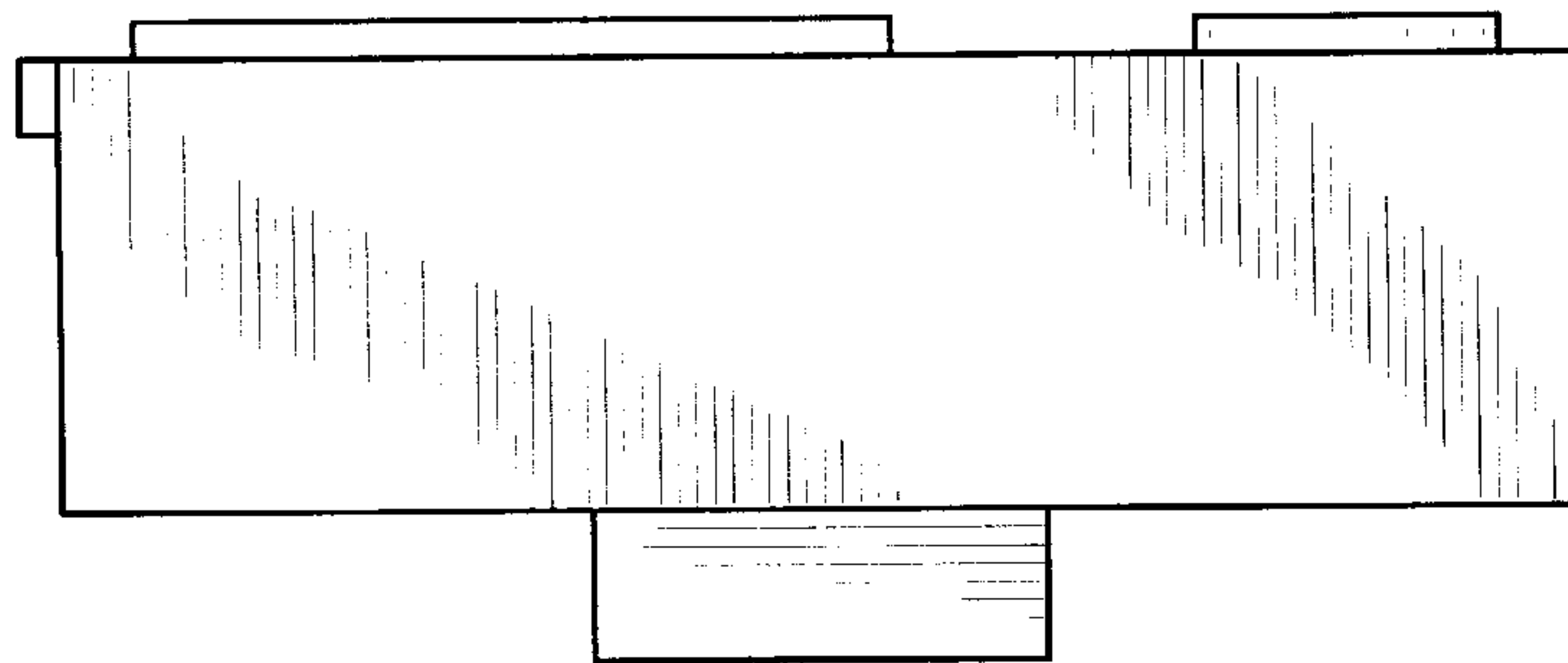


FIG. 7

