



US00D418050S

United States Patent [19]

[11] **Patent Number: Des. 418,050**

Lisiecki et al.

[45] **Date of Patent: ** Dec. 28, 1999**

[54] WINDOW OPERATOR

[75] Inventors: **Elizabeth Lisiecki**, Streamwood; **Paul Stephan**, Rockton; **Robert A. O'Neil**, Glen Ellyn, all of Ill.; **Ted A. Bell**, Killen, Ala.

[73] Assignee: **Newell Operating Company**, Freeport, Ill.

[**] Term: **14 Years**

[21] Appl. No.: **29/071,582**

[22] Filed: **May 30, 1997**

[51] **LOC (6) Cl.** **08-09**

[52] **U.S. Cl.** **D8/400**

[58] **Field of Search** 16/110 R, 115; 292/347; D8/308, 309, 400, 499; 49/324, 325, 339, 337, 341, 342, 360, 353; 74/84.14, 89.18, 545, 546

[56] **References Cited**

U.S. PATENT DOCUMENTS

D. 331,531	12/1992	Guhl et al.	D8/309
D. 376,099	12/1996	Orf et al.	D8/400
D. 390,454	2/1998	Vetter et al.	D8/400
D. 390,777	2/1998	Peterson et al.	D8/400

OTHER PUBLICATIONS

Crank Handles, Blaine Window Hardware, Aug. 1983.

Primary Examiner—Susan J. Lucas

Assistant Examiner—Jennifer Rivard

Attorney, Agent, or Firm—Foley & Lardner

[57] **CLAIM**

The ornamental design for a window operator, as shown and described.

DESCRIPTION

FIG. 1 is a right side perspective view of a window operator showing our design.

FIG. 2 is a top plan view of the design.

FIG. 3 is a front elevation view of the design.

FIG. 4 is a left side elevation view of the design.

FIG. 5 is a right side elevation view of the design.

FIG. 6 is a right side perspective view of the design according to a second embodiment.

FIG. 7 is a top plan view of the design according to the alternative embodiment.

FIG. 8 is a front elevation view of the design according to the alternative embodiment.

FIG. 9 is a left side elevation view of the design according to the alternative embodiment.

FIG. 10 is a right side elevation view of the design according to the alternative embodiment.

FIG. 11 is a right side perspective view of the design according to a third embodiment.

FIG. 12 is a top plan view of the design according to the alternative embodiment.

FIG. 13 is a front elevation view of the design according to the alternative embodiment.

FIG. 14 is a left side elevation view of the design according to the alternative embodiment.

FIG. 15 is a right side elevation view of the design according to the alternative embodiment.

FIG. 16 is a right side perspective view of the design according to a fourth embodiment.

FIG. 17 is a top plan view of the design according to the alternative embodiment.

FIG. 18 is a front elevation view of the design according to the alternative embodiment.

FIG. 19 is a left side elevation view of the design according to the alternative embodiment; and,

FIG. 20 is a right side elevation view of the design according to the alternative embodiment.

The broken line illustration in the drawing disclosure is for illustrative purposes only and forms no part of the claimed design.

1 Claim, 8 Drawing Sheets

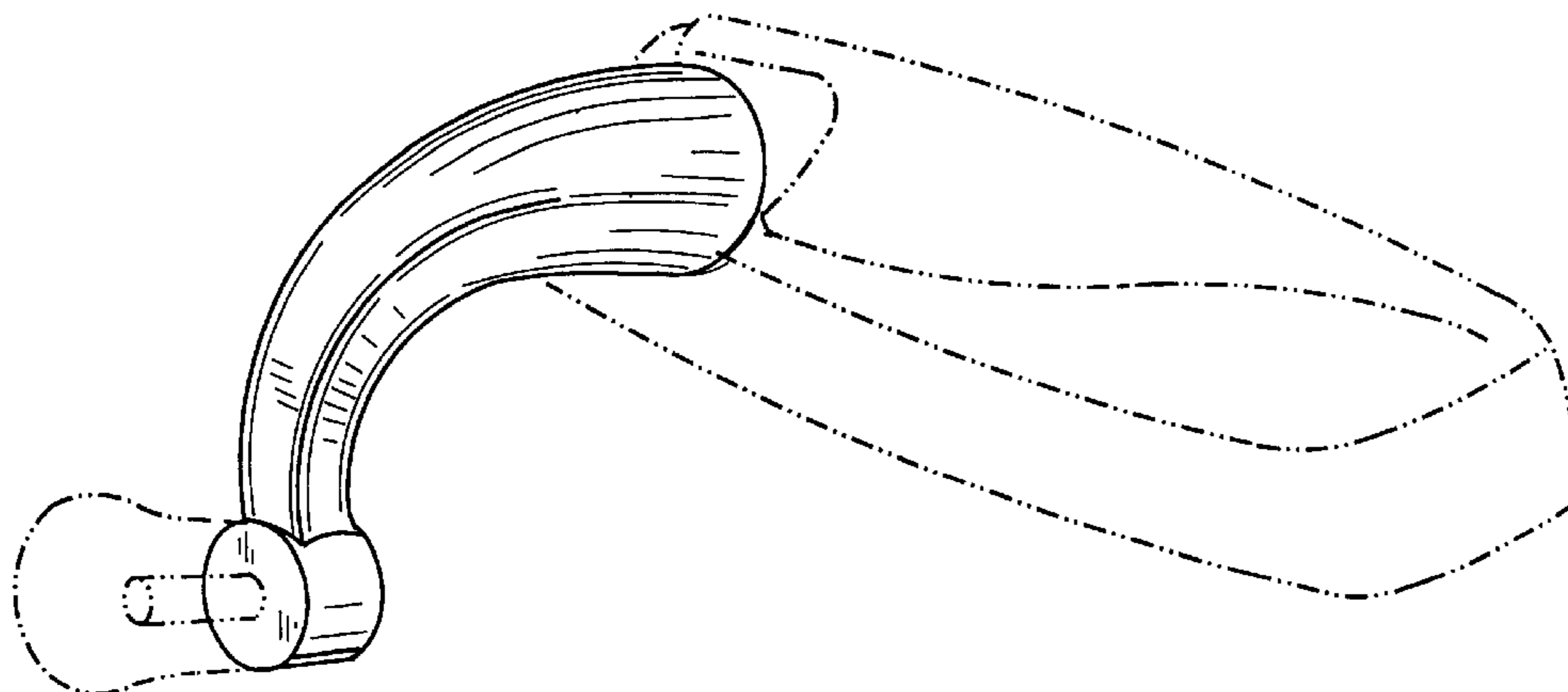

FIG. 1

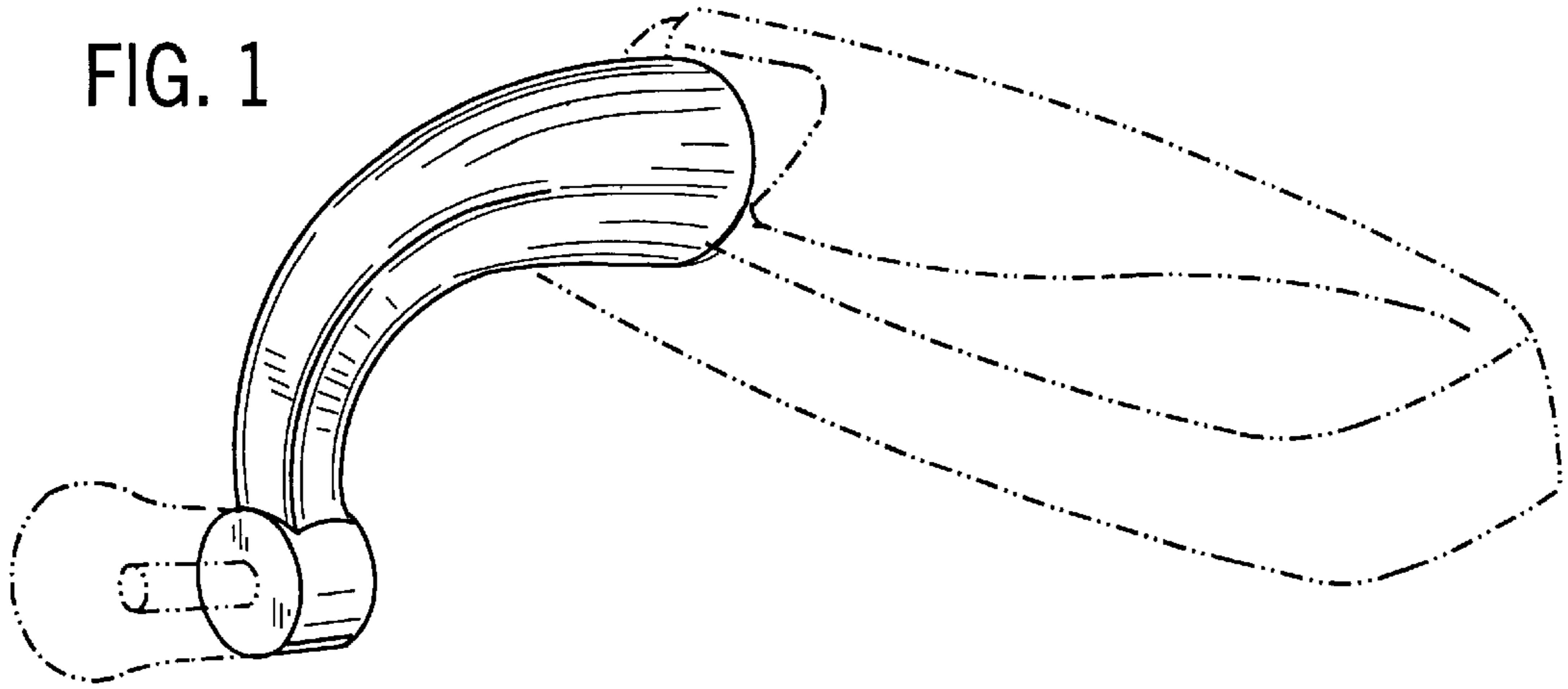

FIG. 2

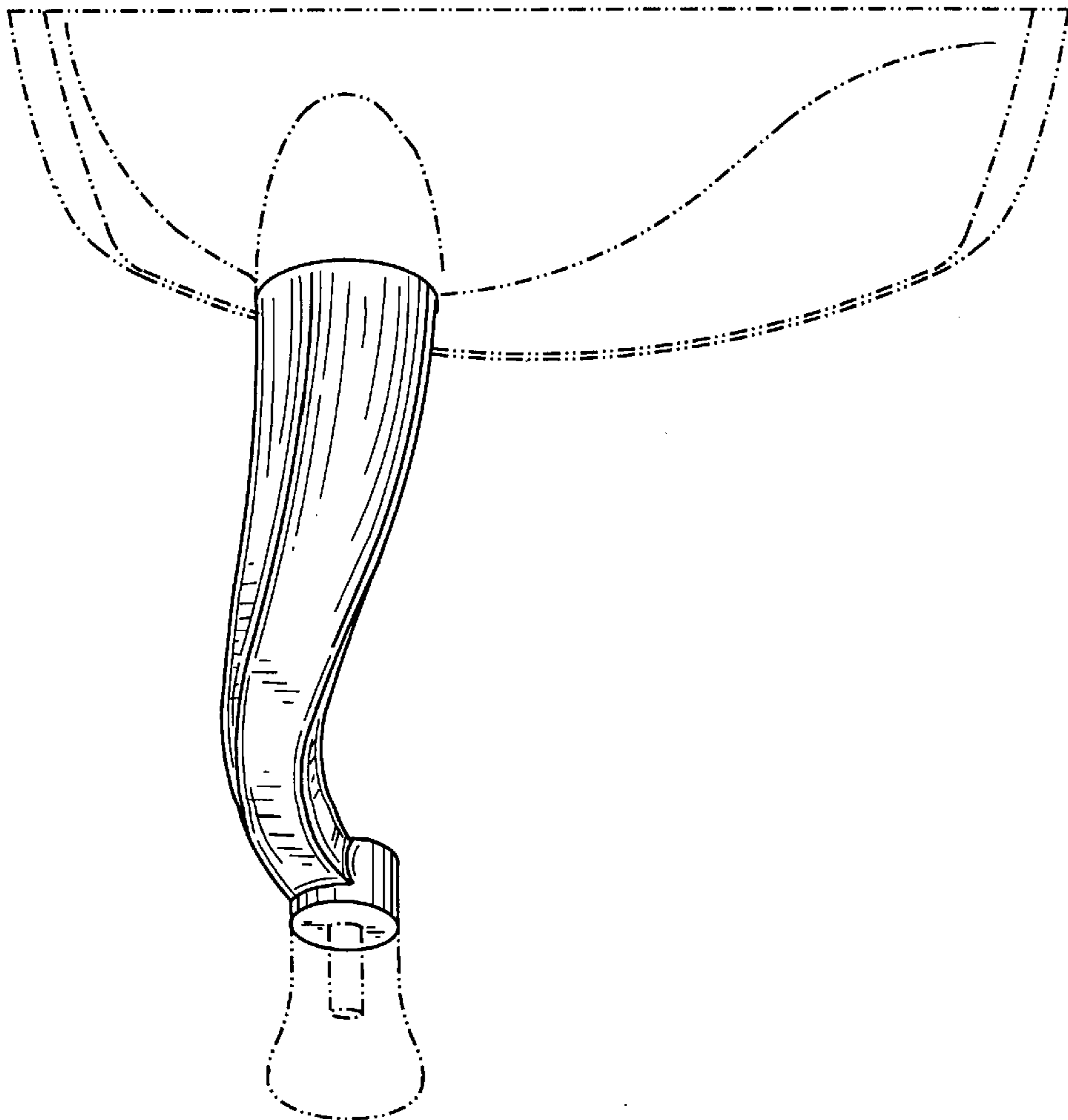

FIG. 3

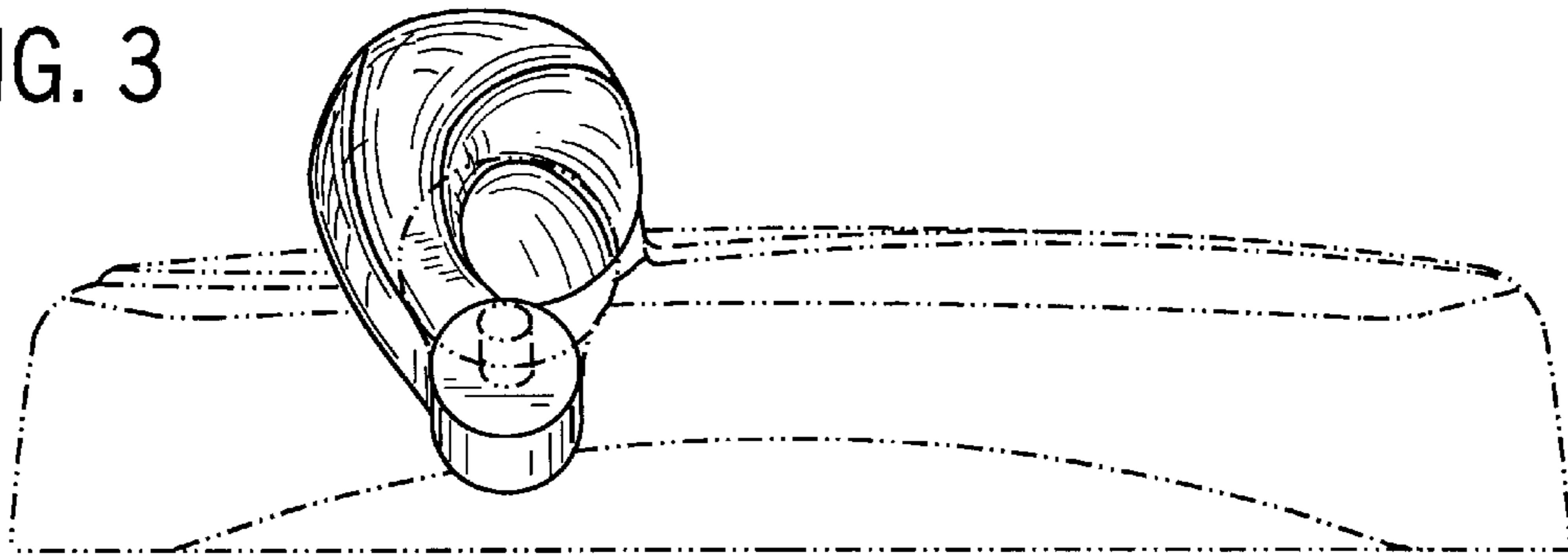

FIG. 4

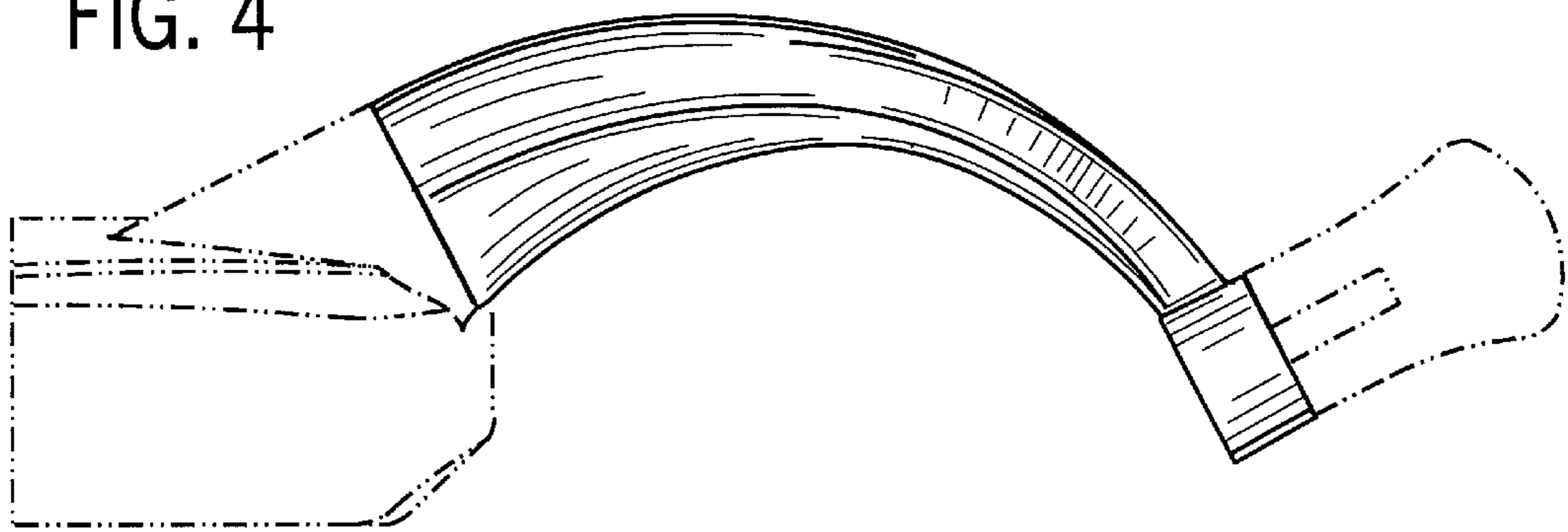

FIG. 5

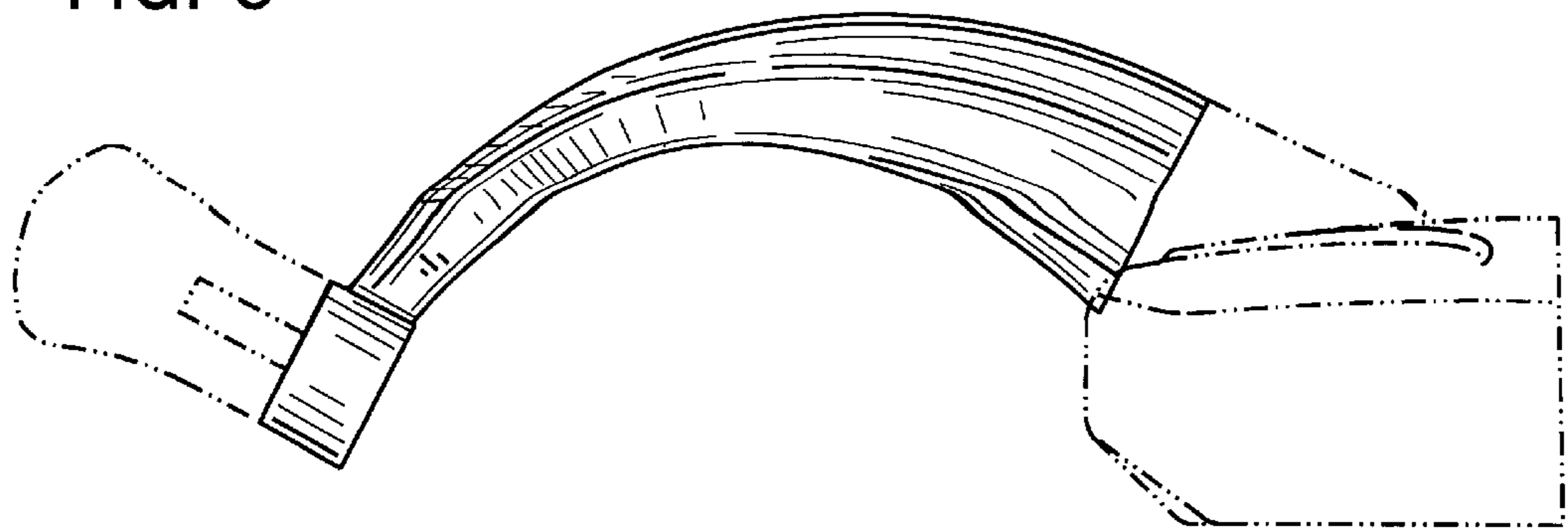

FIG. 6

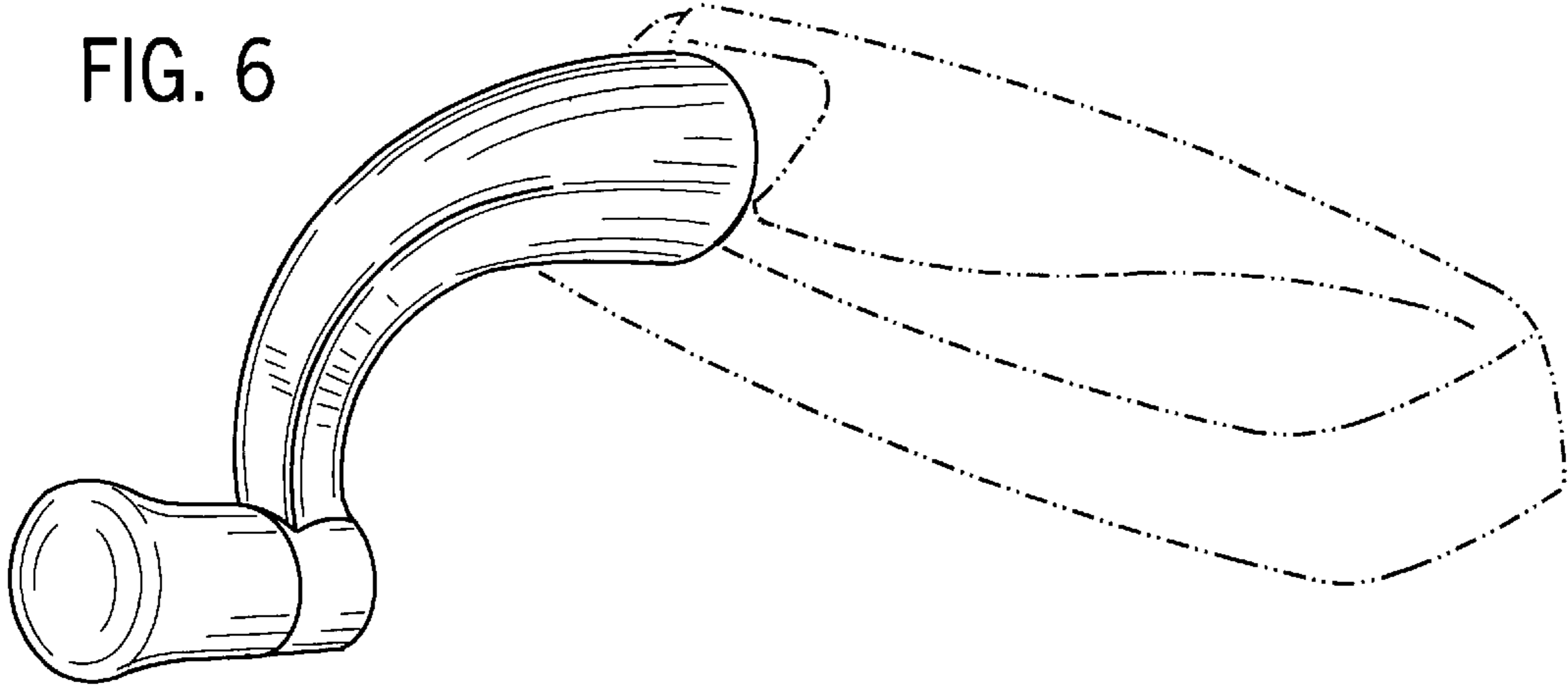

FIG. 7

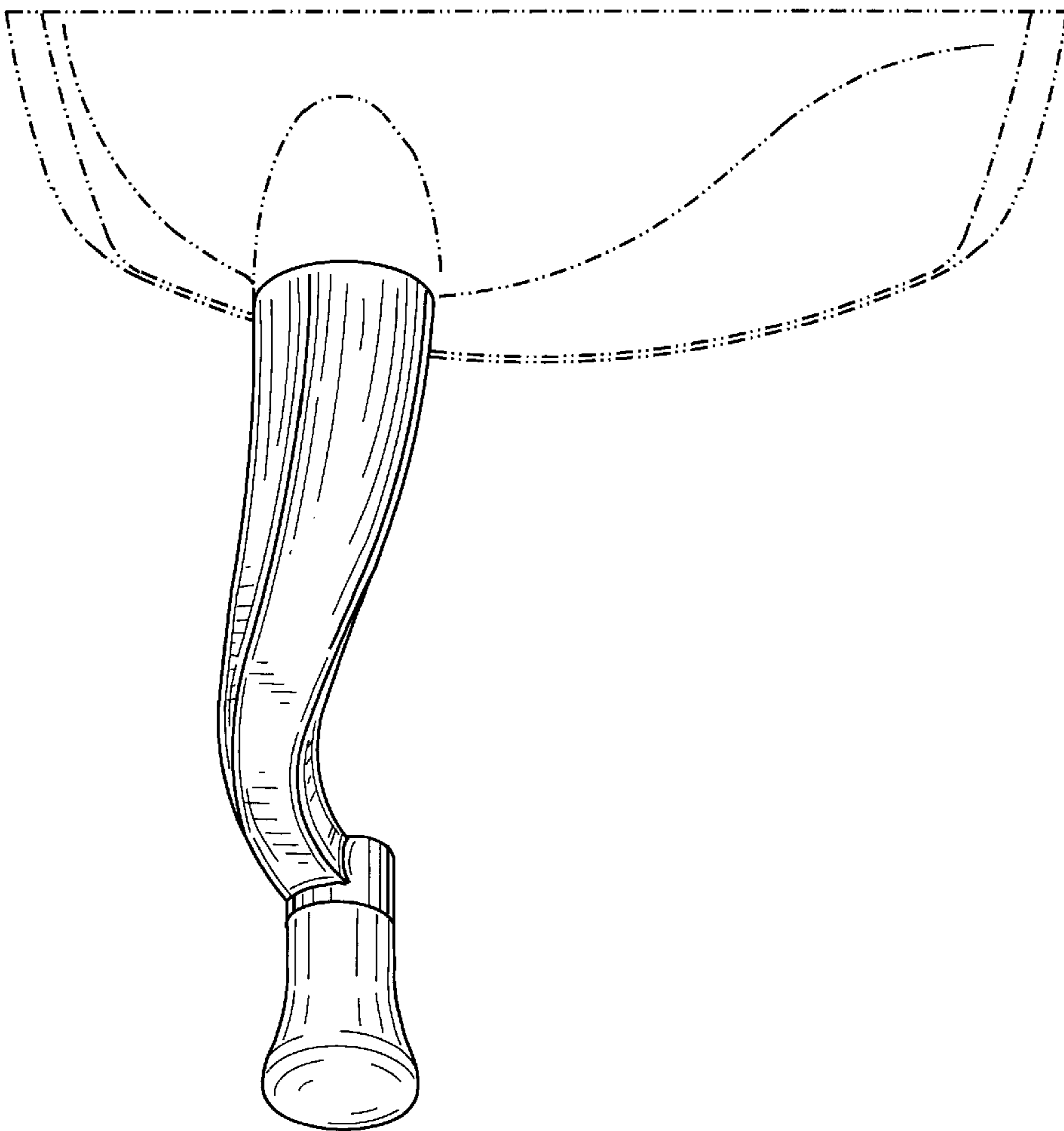

FIG. 8

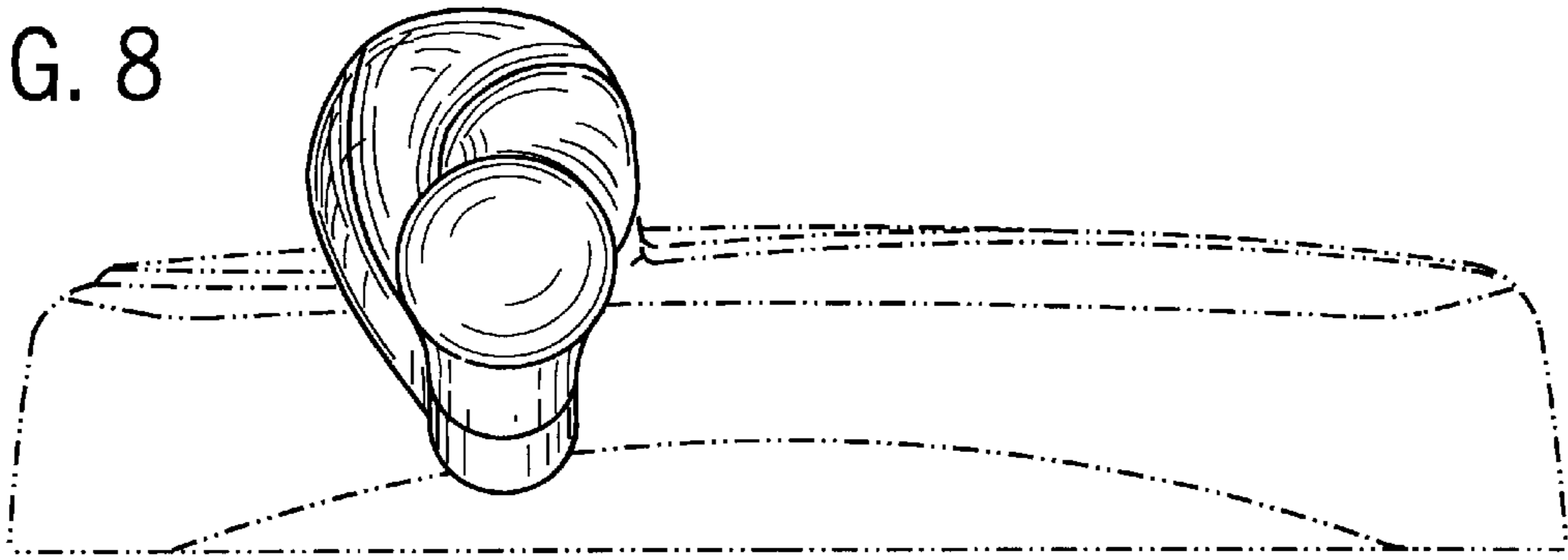

FIG. 9

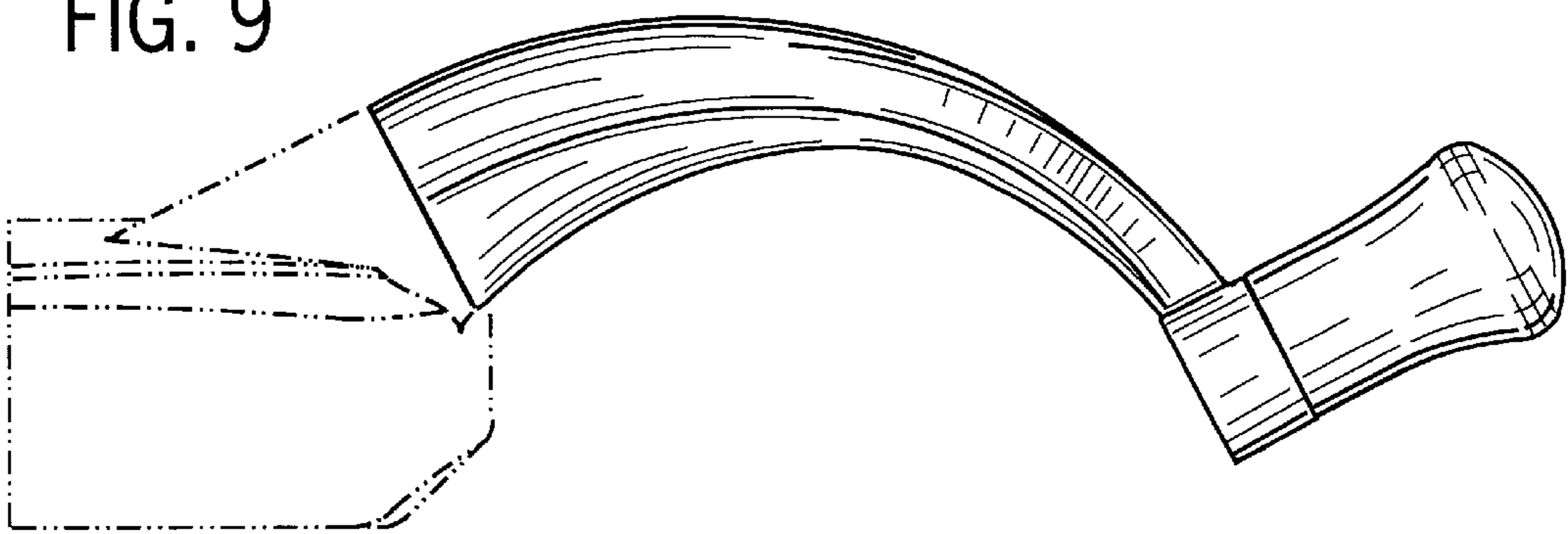

FIG. 10

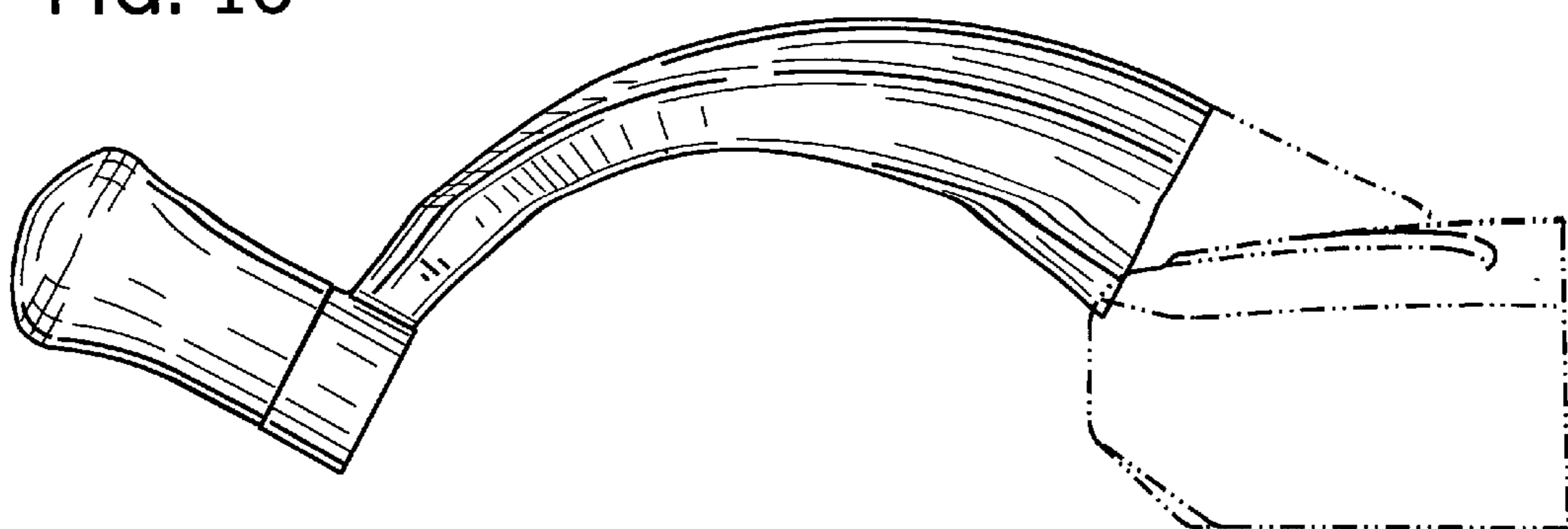

FIG. 11

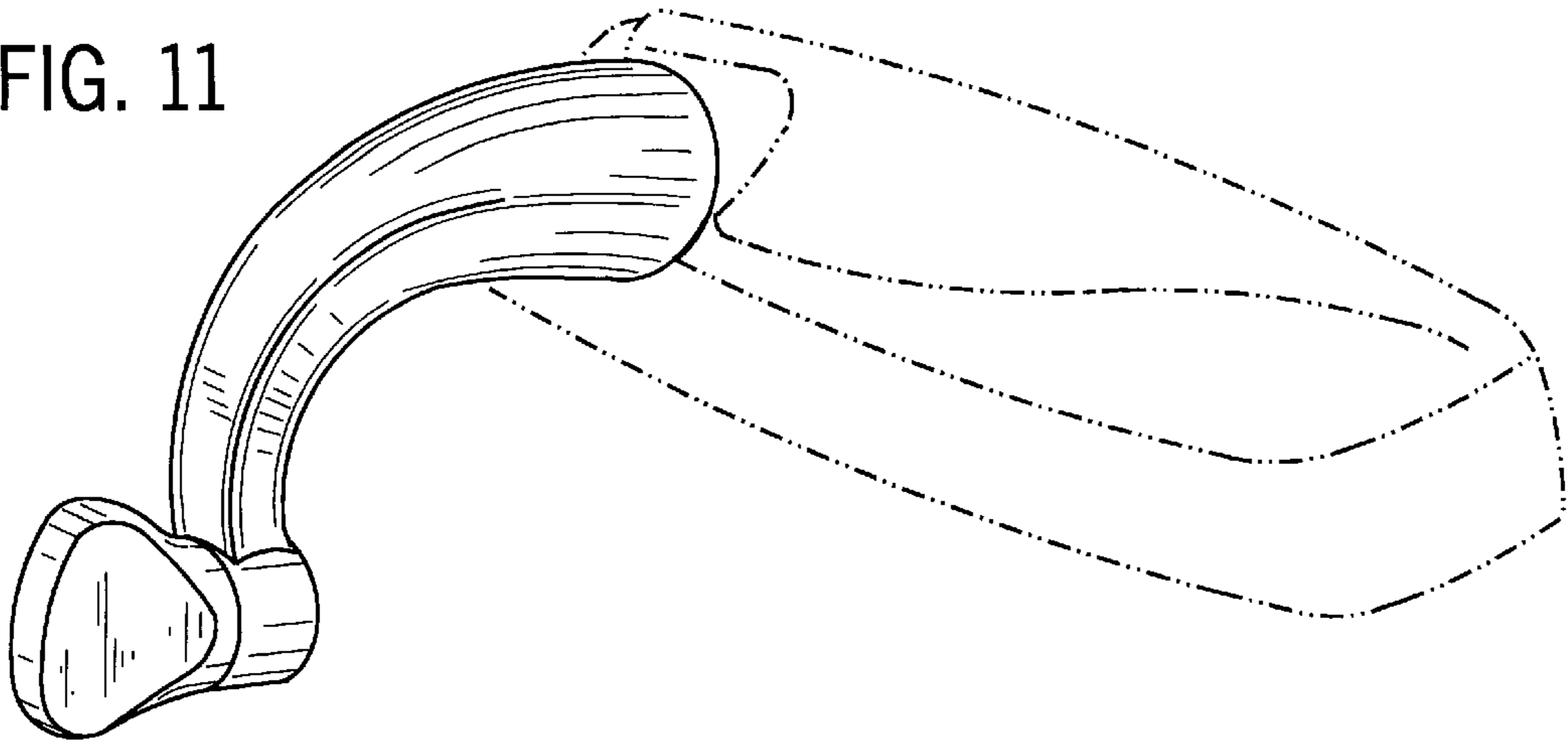

FIG. 12

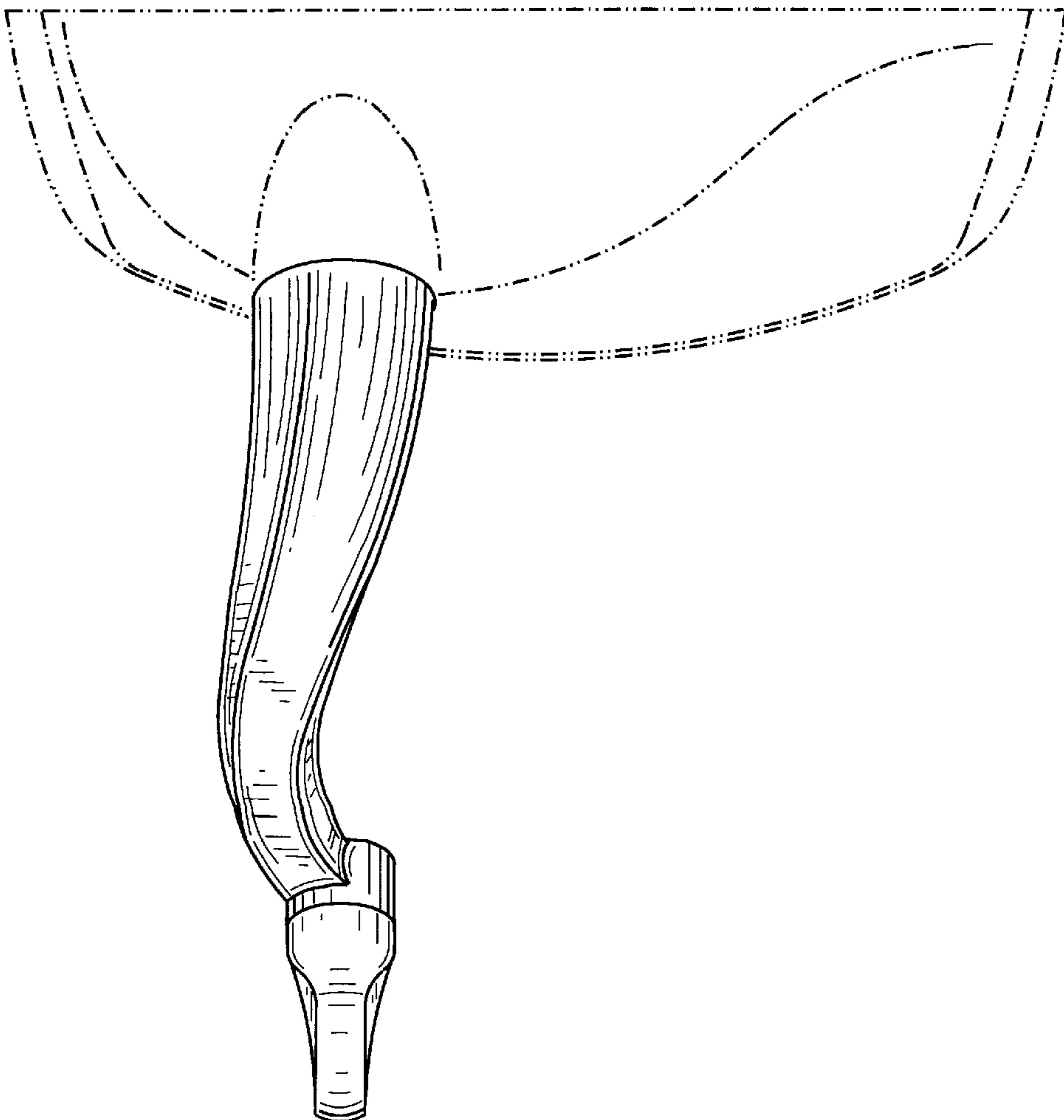

FIG. 13

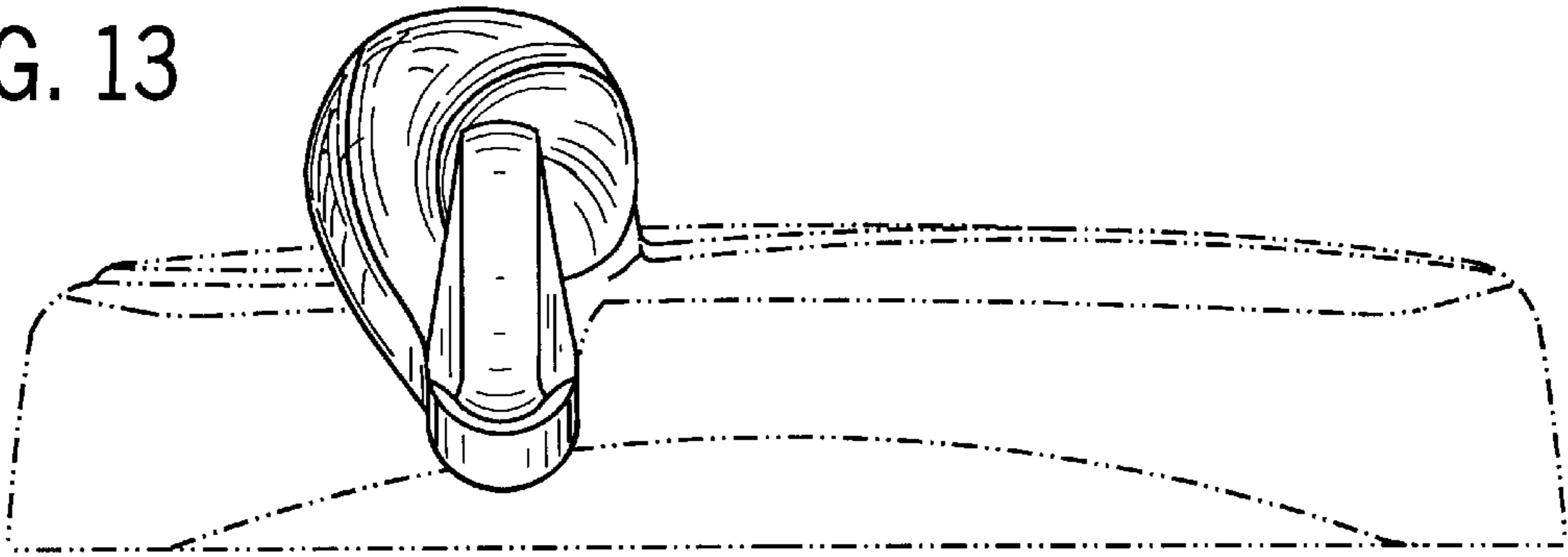

FIG. 14

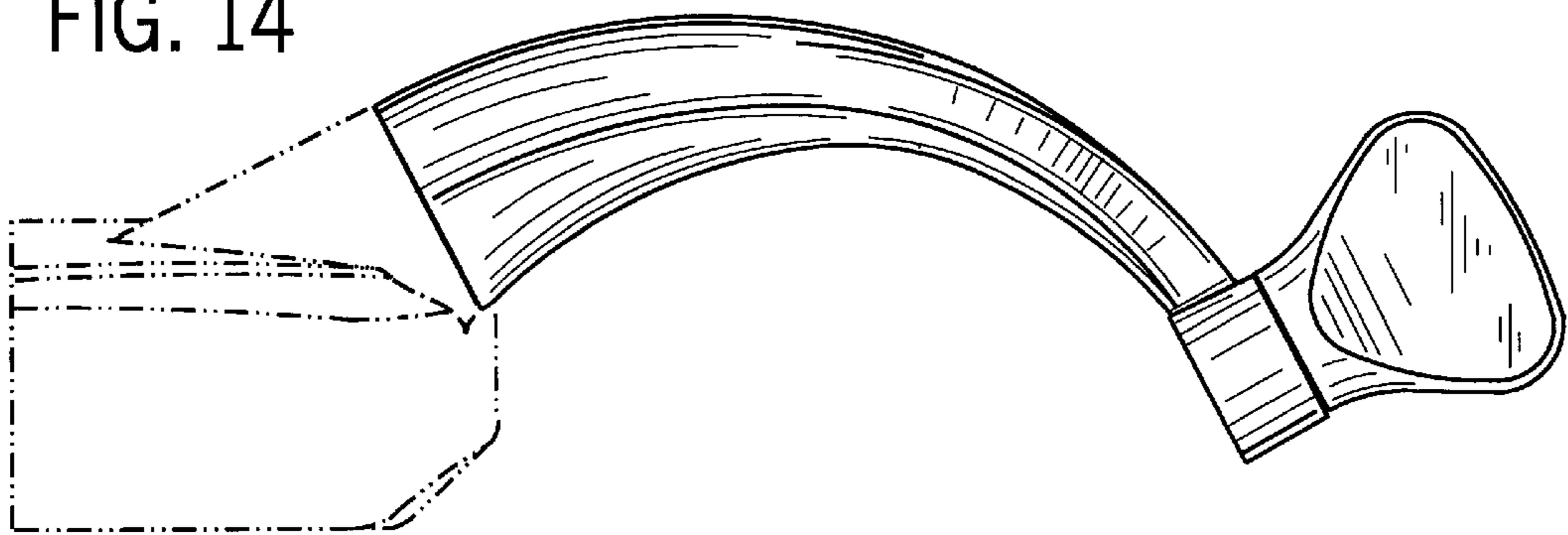

FIG. 15

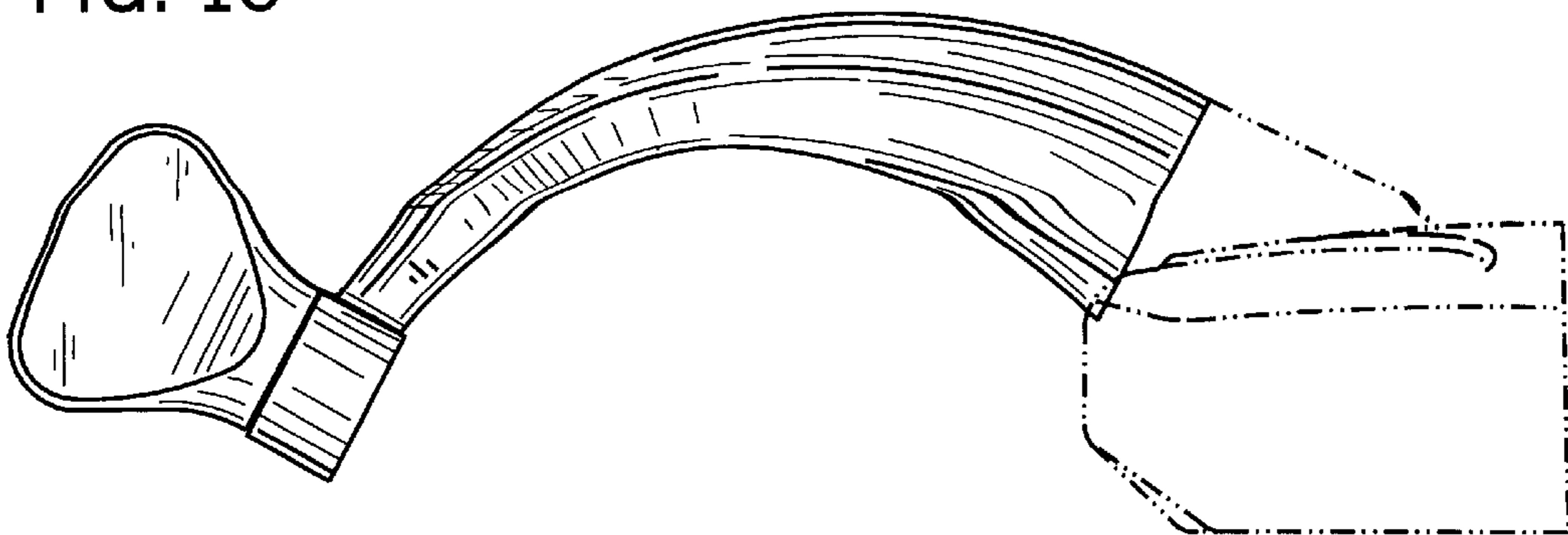

FIG. 16

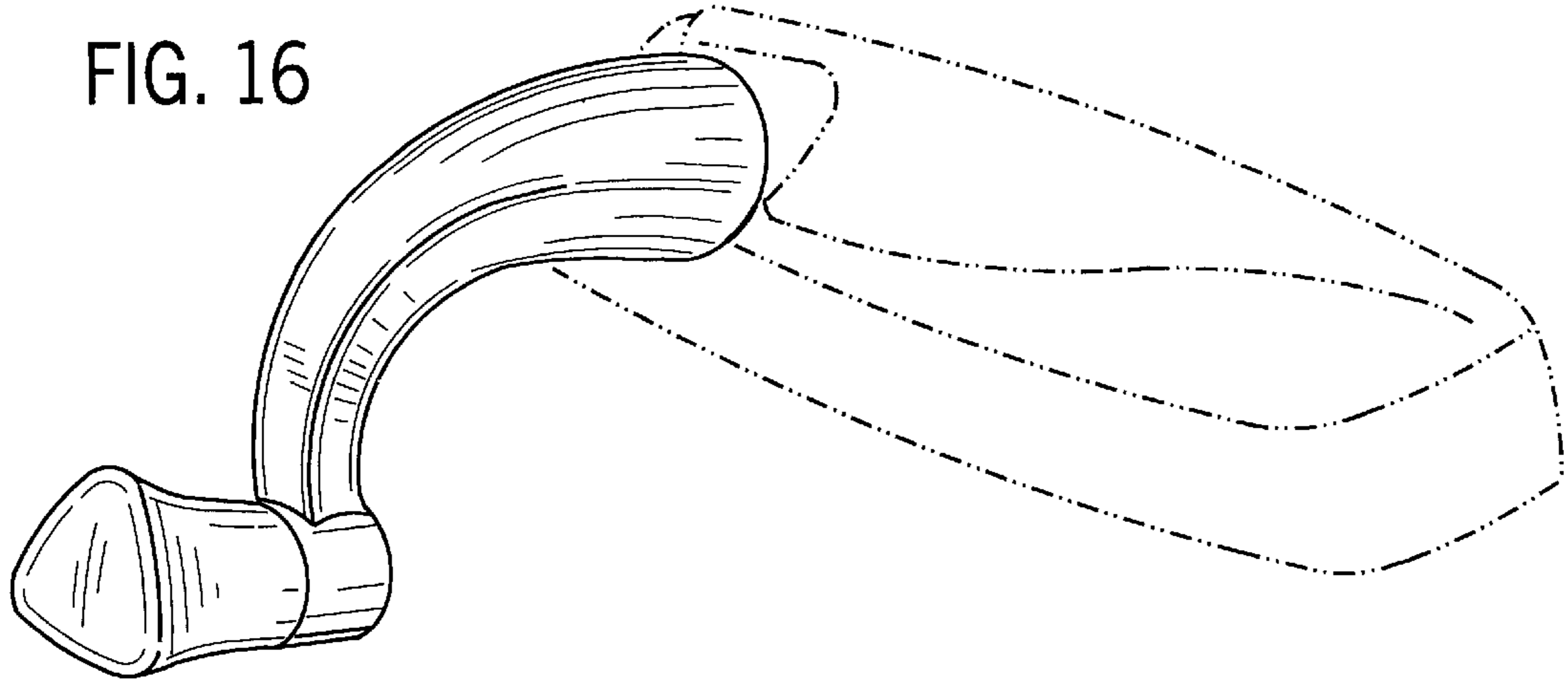

FIG. 17

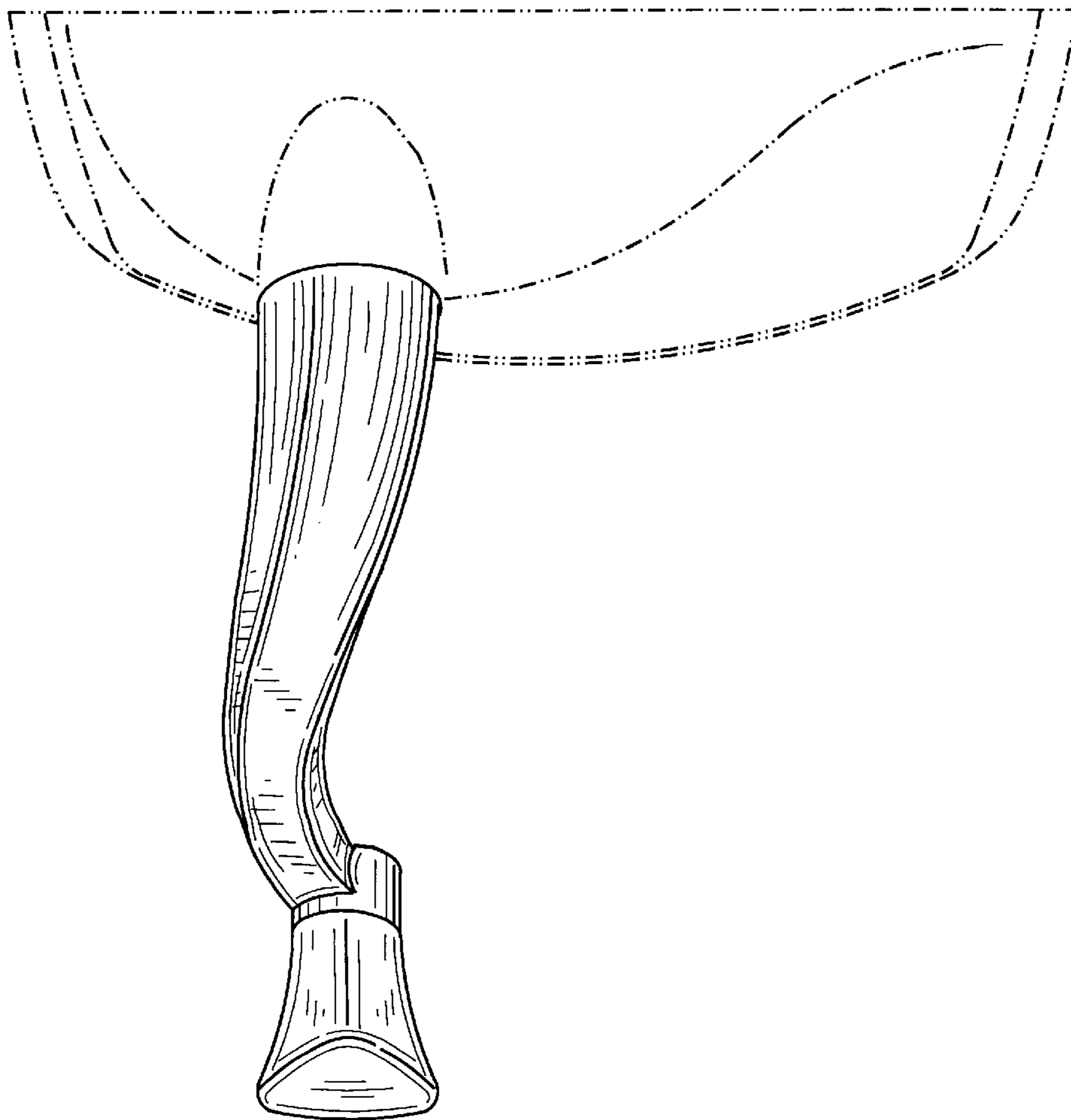

FIG. 18

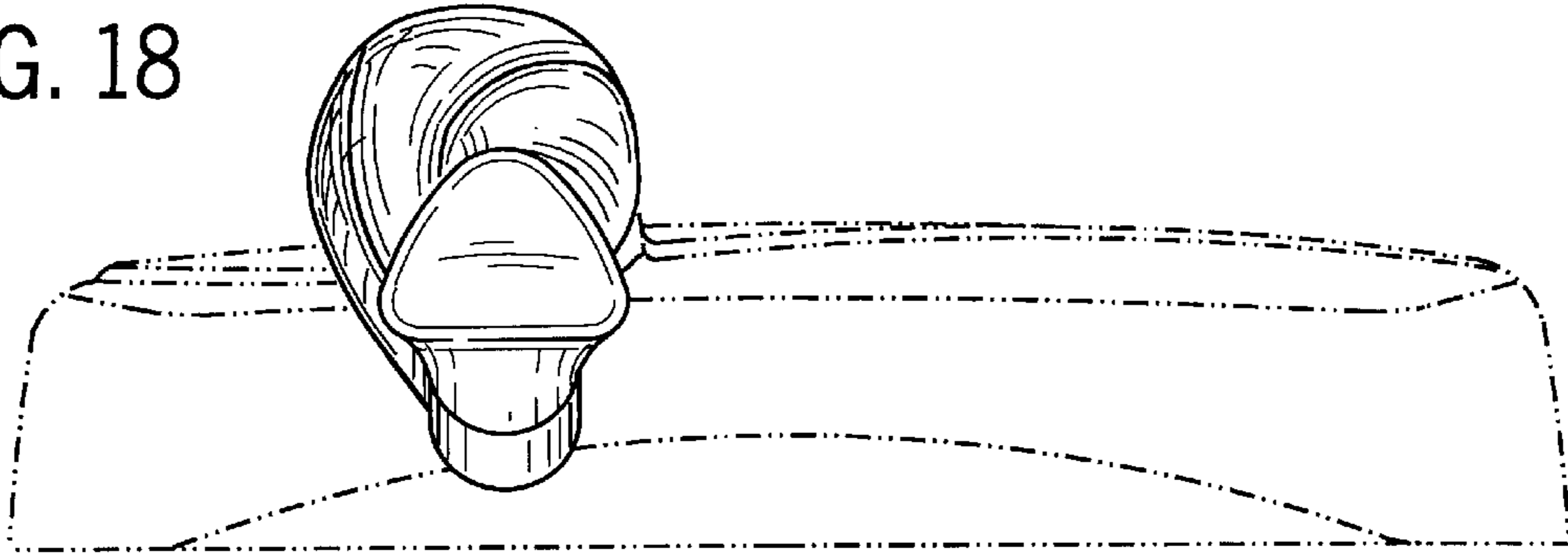

FIG. 19

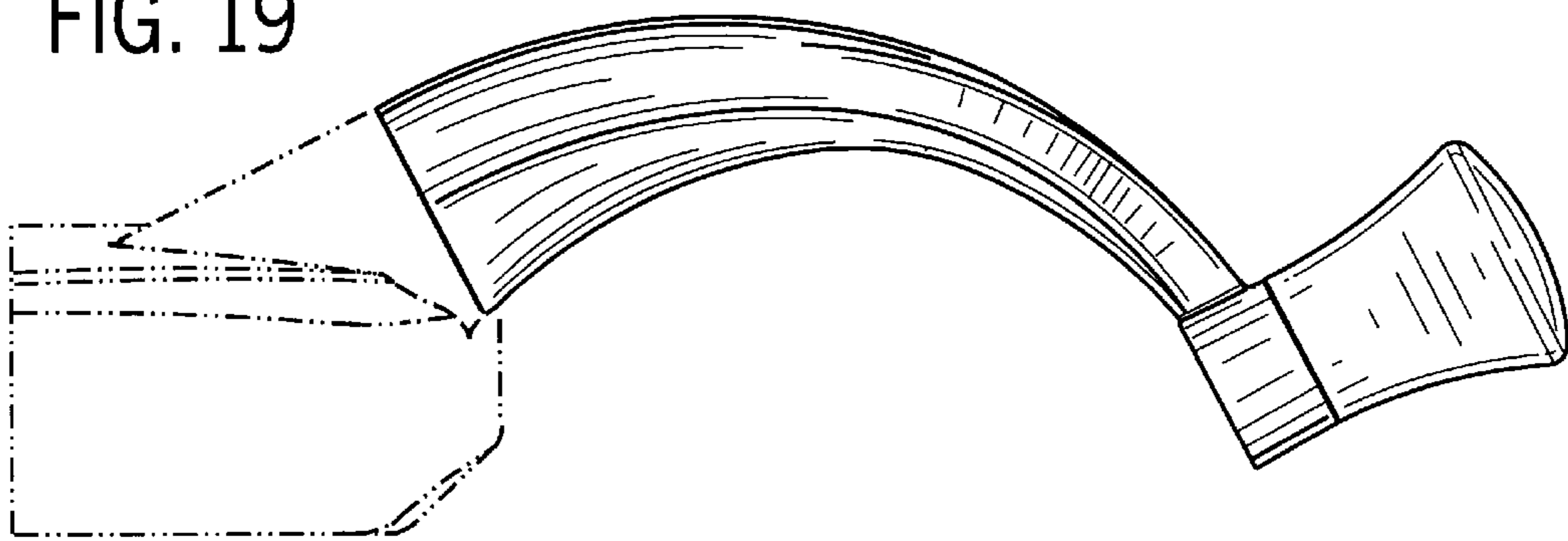

FIG. 20

