



US00D418008S

United States Patent [19]

[11] Patent Number: Des. 418,008

Rachel et al.

[45] Date of Patent: ** Dec. 28, 1999

[54] ROASTER

[57] CLAIM

[76] Inventors: **Patria F. Rachel; Robert J. Rachel**,
both of 370 Shelley Renee La.,
Cordova, Tenn. 38018

The ornamental design for a roaster, as shown and described.

[**] Term: 14 Years

DESCRIPTION

[21] Appl. No.: 29/097,616

FIG. 1 is a top plan view of a roaster showing our new design;

[22] Filed: Dec. 10, 1998

FIG. 2 is a front elevational view of the roaster of FIG. 1;

[51] LOC (6) Cl. 07-02

[52] U.S. Cl. D7/359

[58] Field of Search D7/323, 354-361,
D7/409, 544, 546; 99/419, 425, 426, 442,
444; 220/573.1, 573.4, 574, 575, 912

FIG. 3 is a bottom plan view of the roaster of FIG. 1;

FIG. 4 is a rear elevational view of the roaster of FIG. 1;

FIG. 5 is a left side elevational view of the roaster of FIG. 1;

[56] References Cited

U.S. PATENT DOCUMENTS

D. 104,837 6/1937 Ebeling D7/544

D. 322,912 1/1992 Schmengler D7/359

FIG. 6 is a right side elevational of the roaster of FIG. 1;

FIG. 7 is a sectional view as taken on line 7—7 of FIG. 1 to more clearly show certain ornamental features of the roaster of FIG. 1;

FIG. 8 is a sectional view as taken on line 8—8 of FIG. 1 to more clearly show certain ornamental features of the roaster of FIG. 1; and,

FIG. 9 is a sectional view as taken on line 9—9 of FIG. 1 to more clearly show certain ornamental features of the roaster of FIG. 1.

Primary Examiner—Caron D. Veynar
Attorney, Agent, or Firm—Walker, McKenzie & Walker,
P.C.

1 Claim, 3 Drawing Sheets

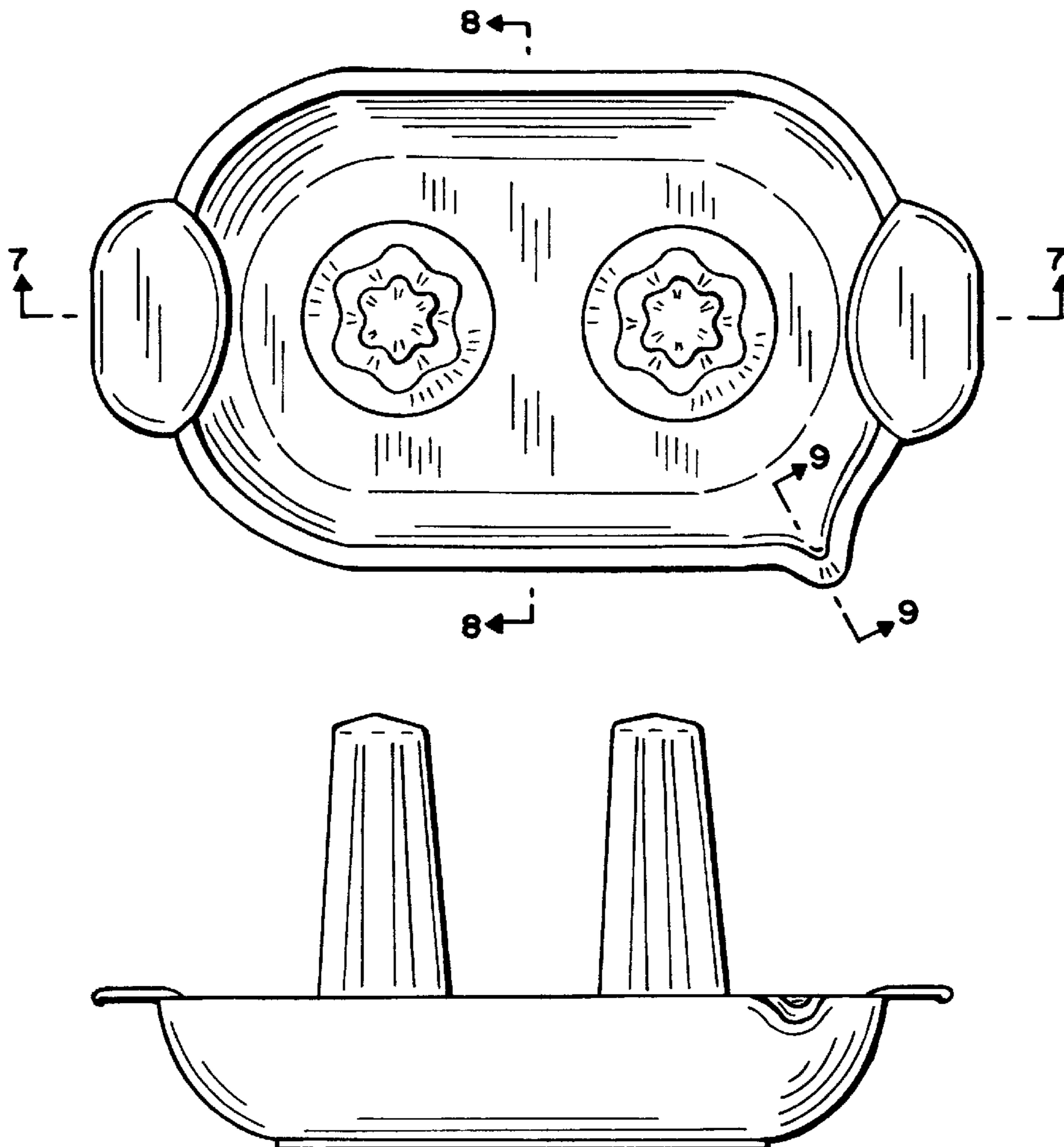

FIG. 1

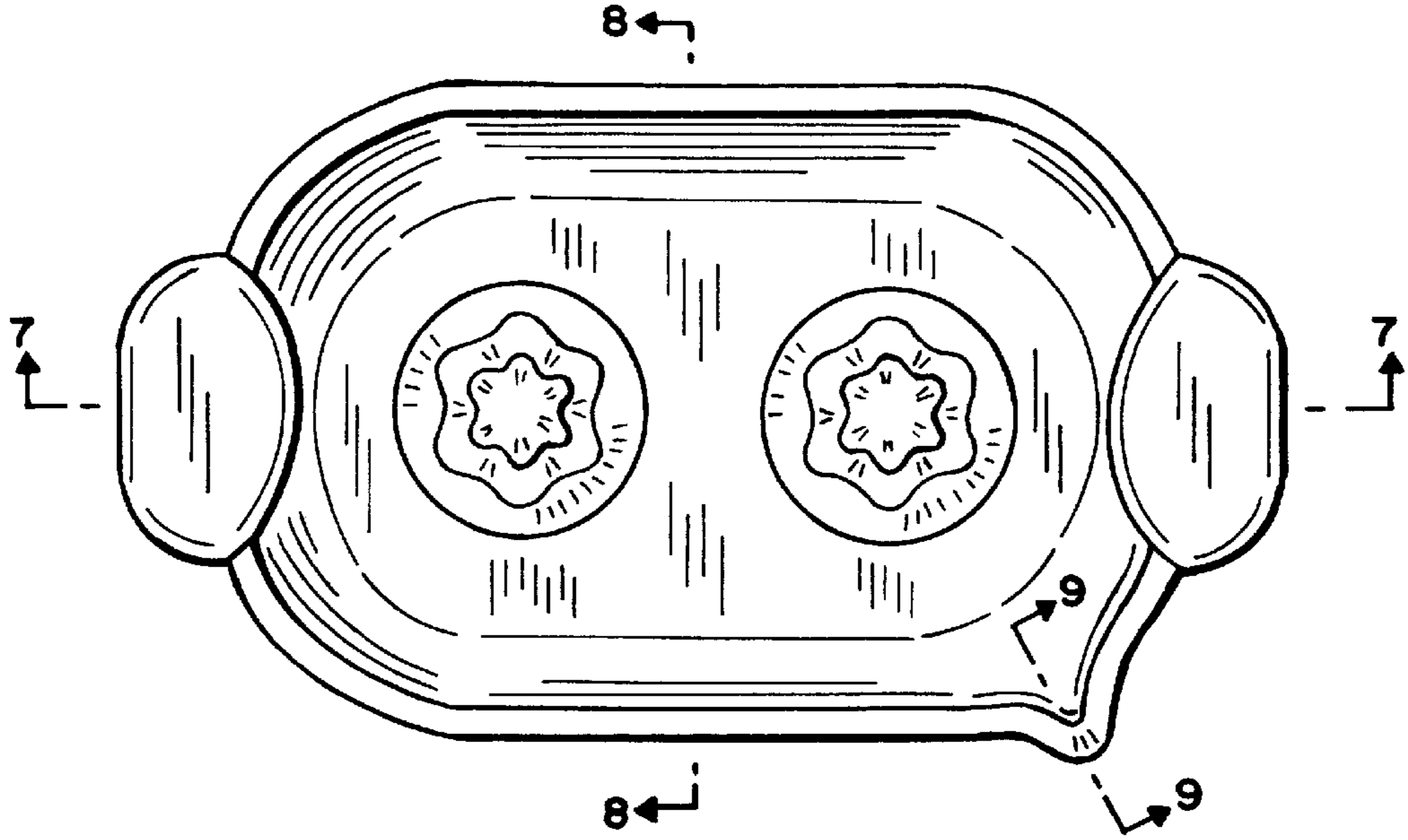

FIG. 2

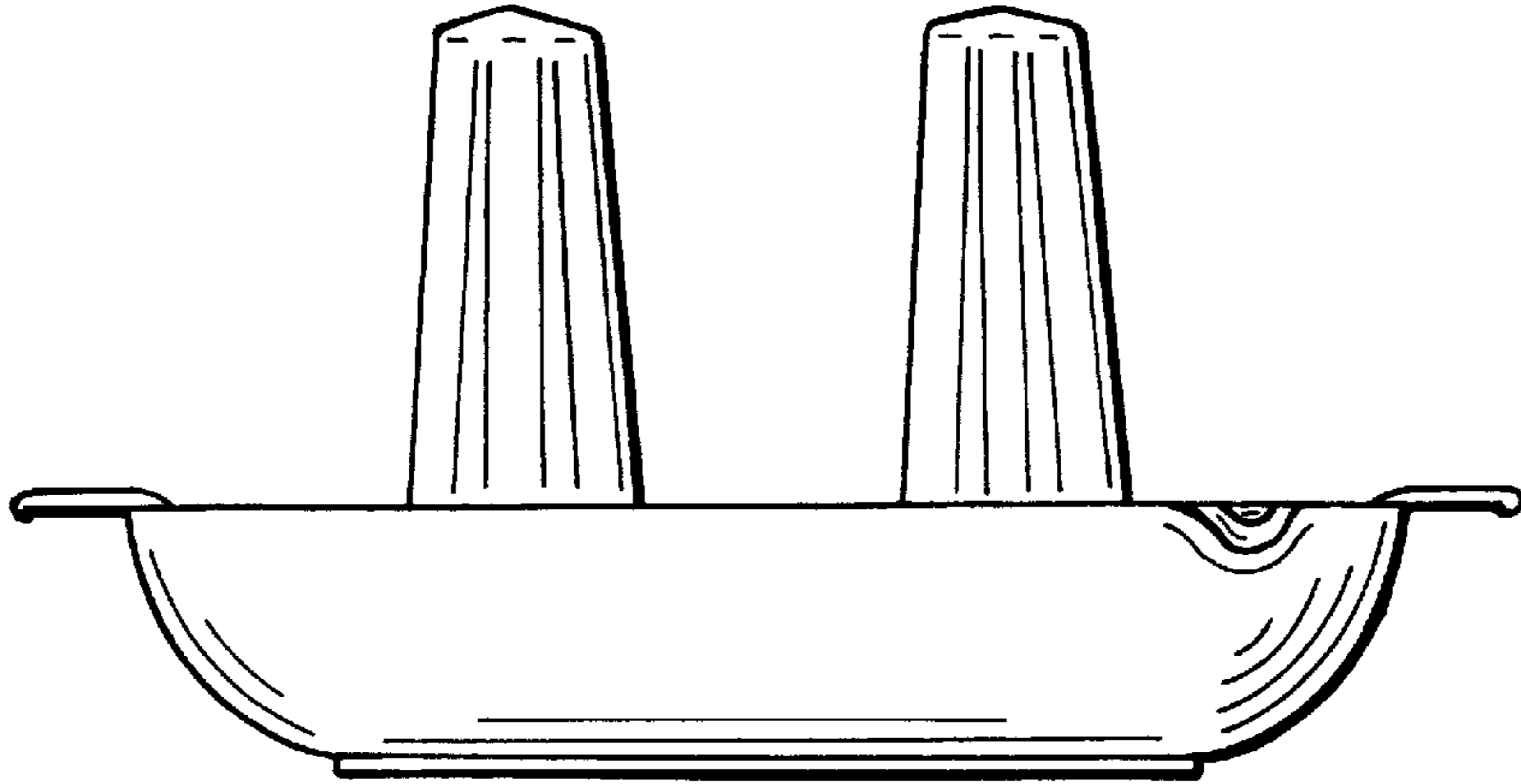

FIG. 3

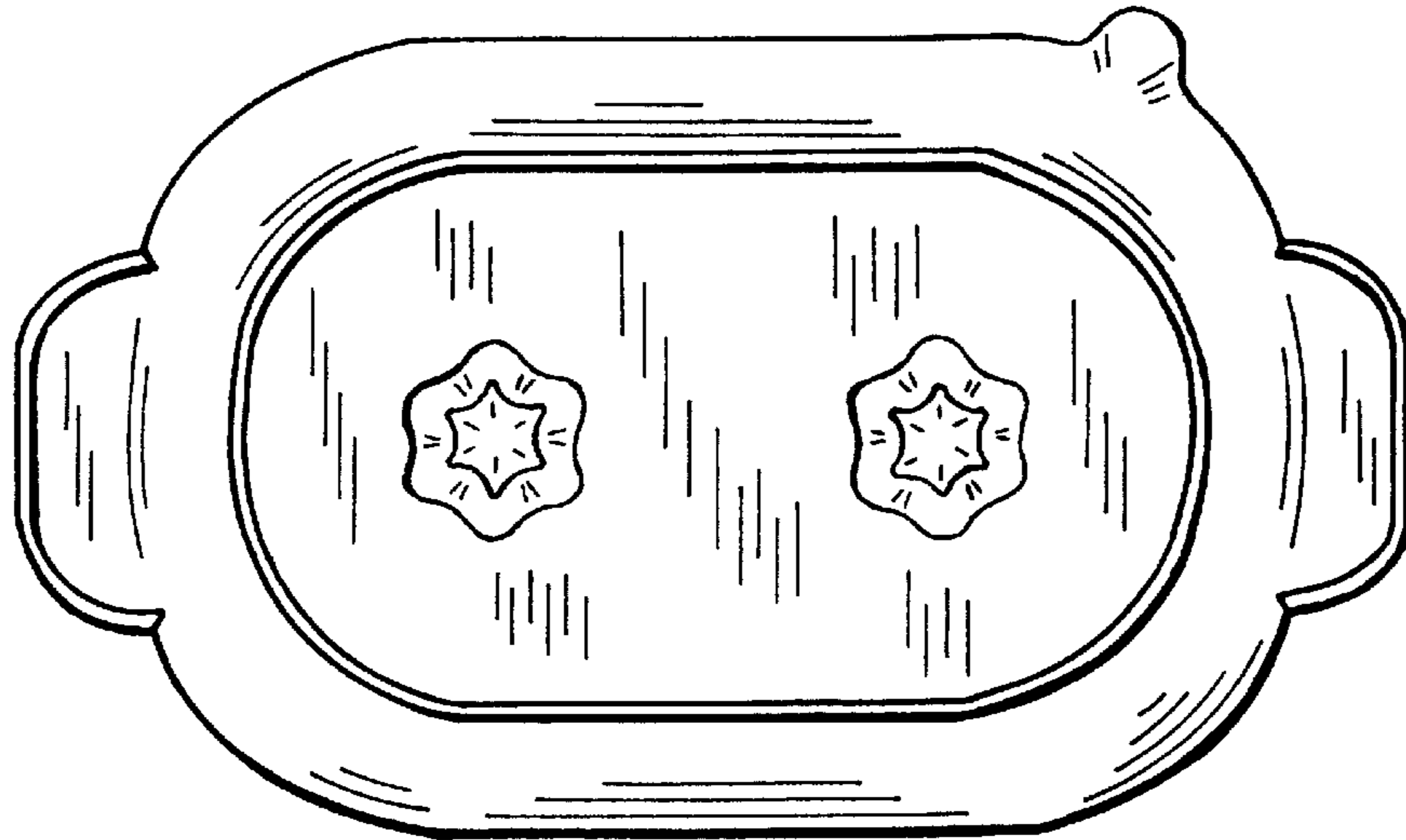

FIG. 4

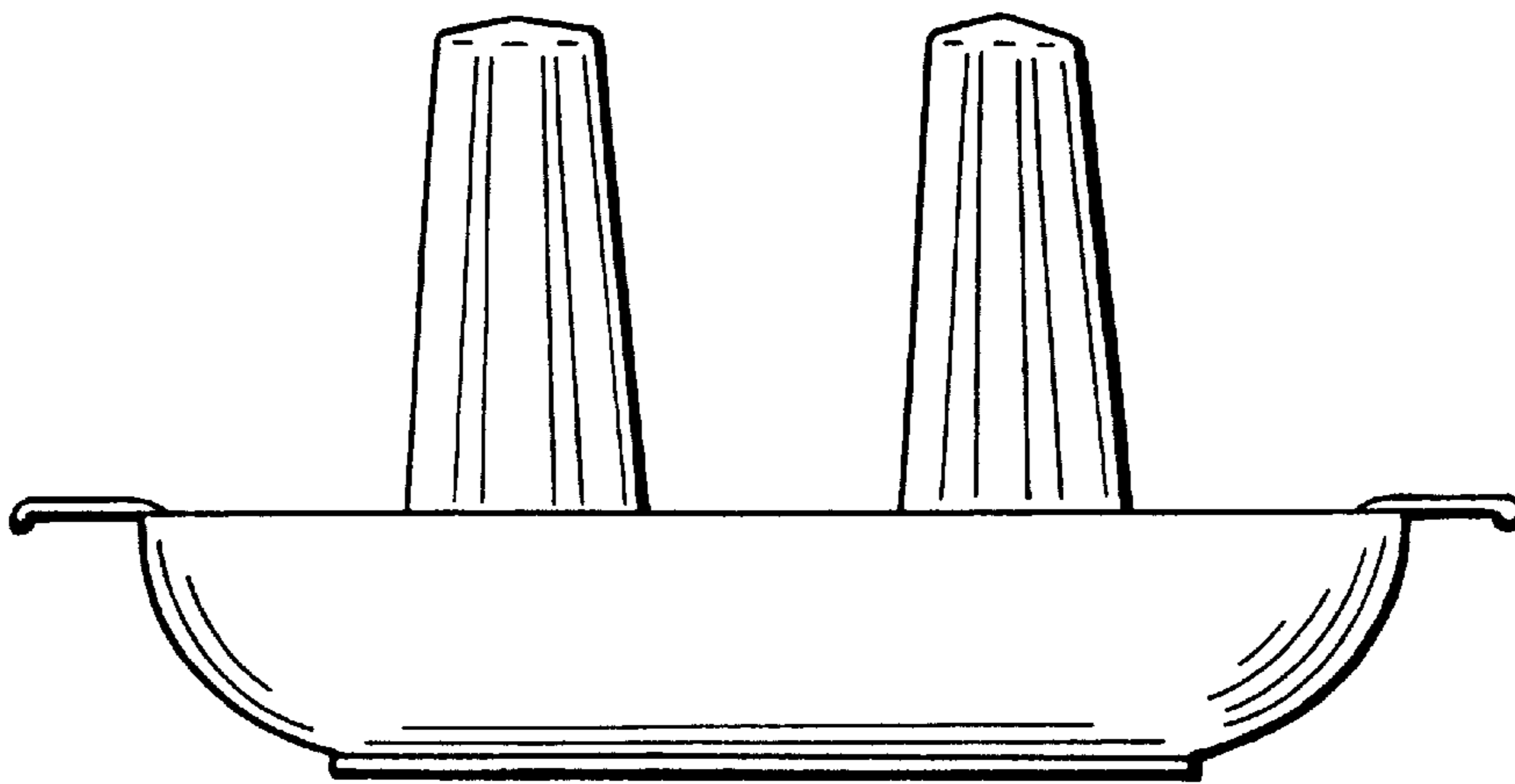

FIG. 5

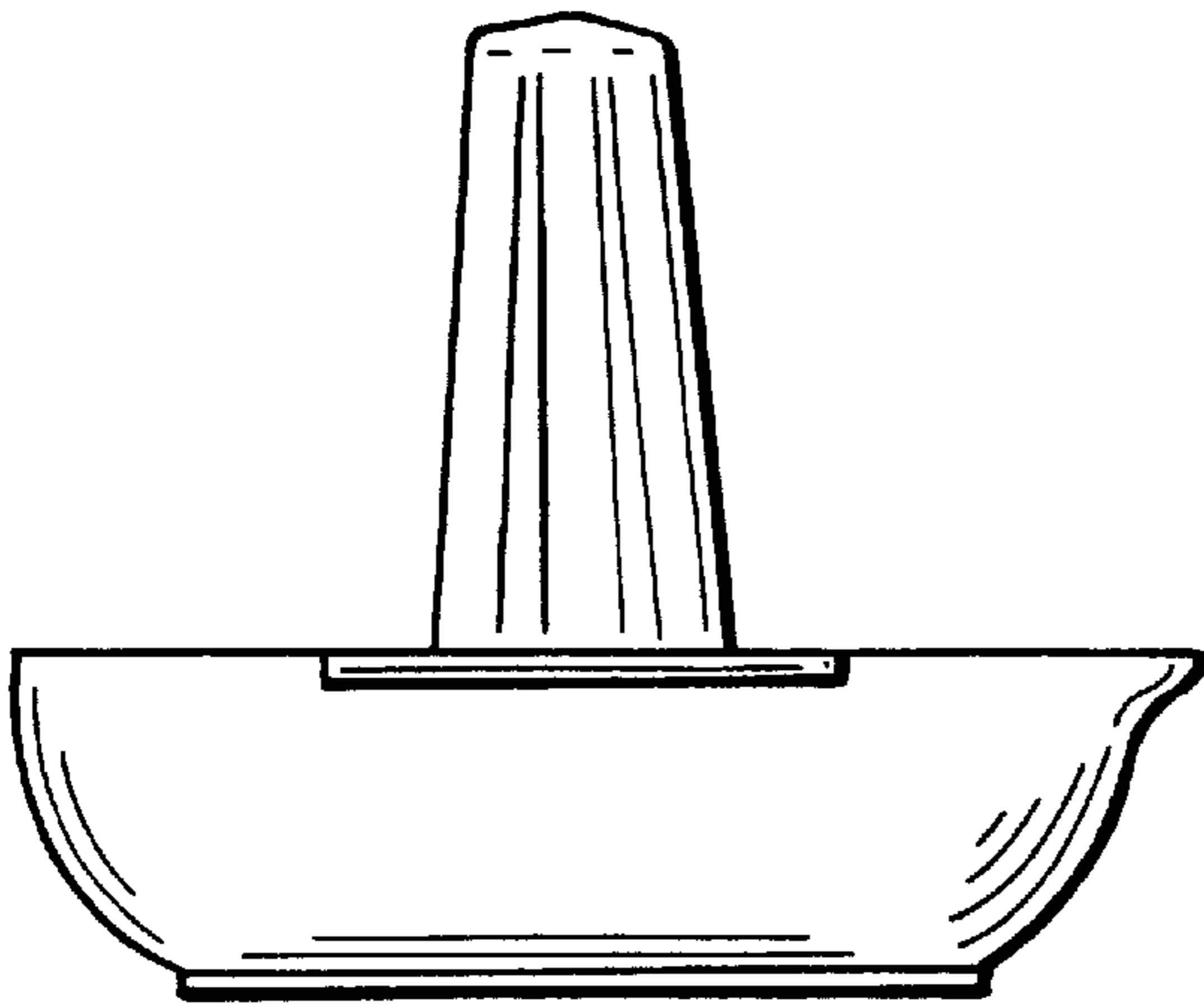

FIG. 6

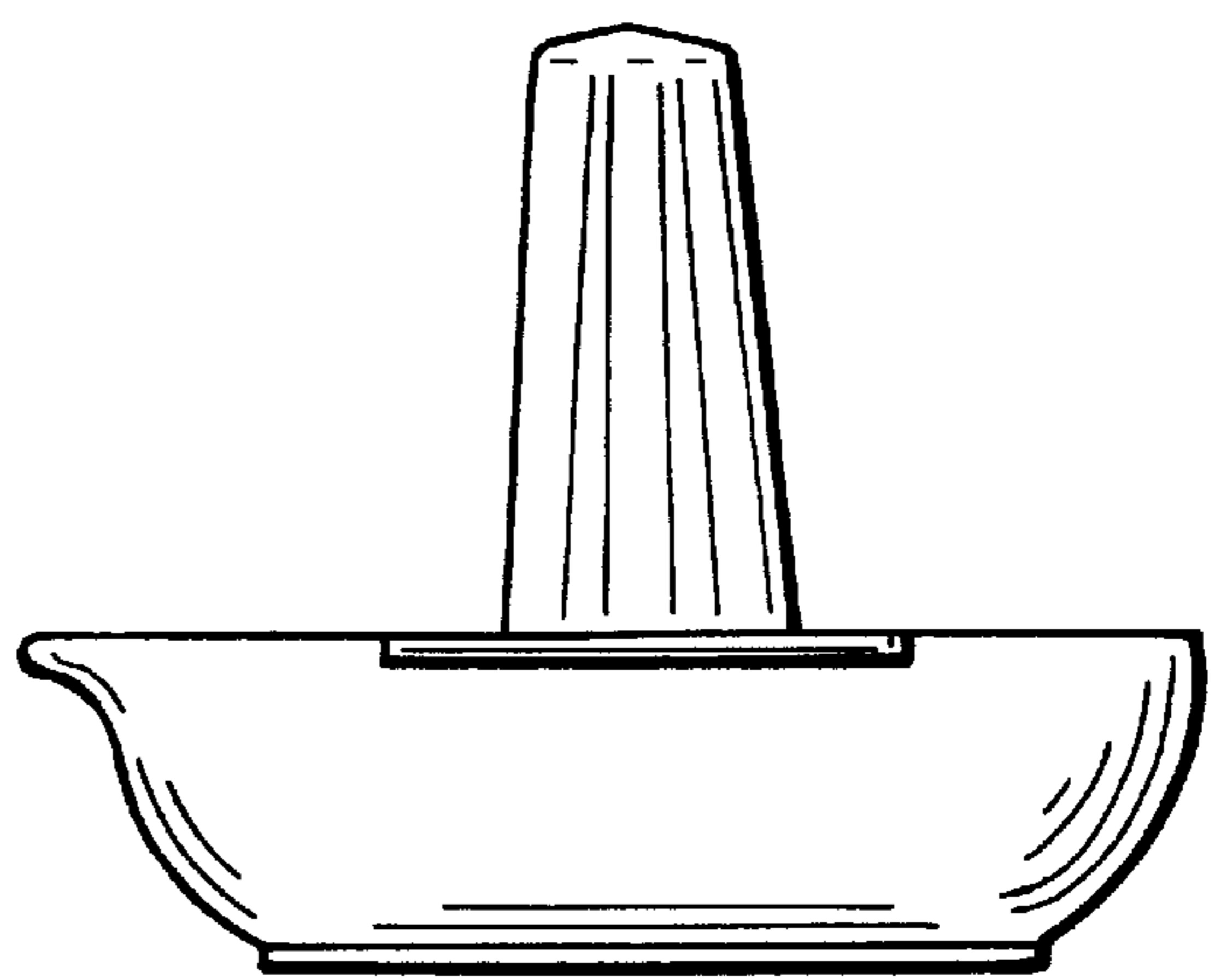

FIG. 7

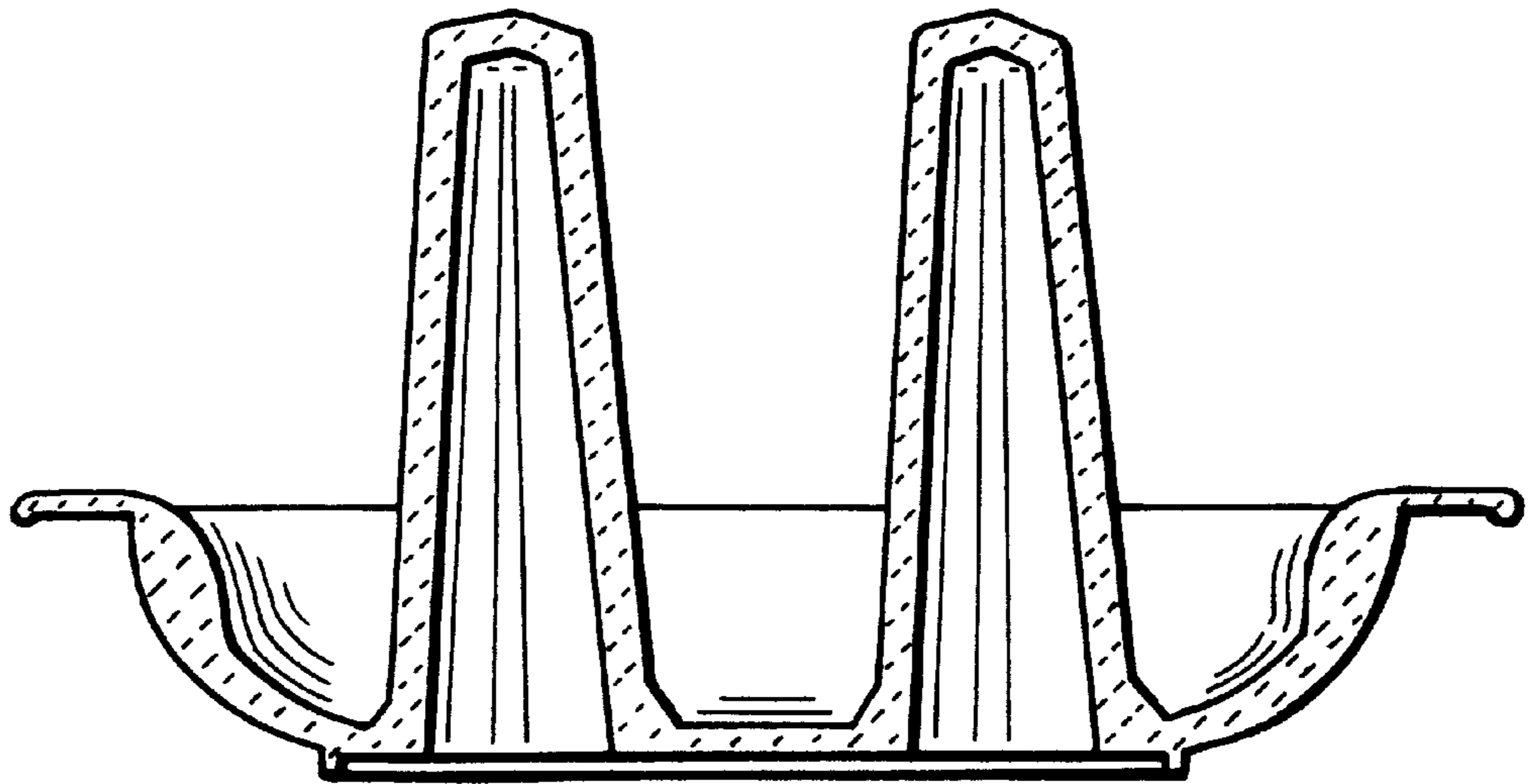

FIG. 8

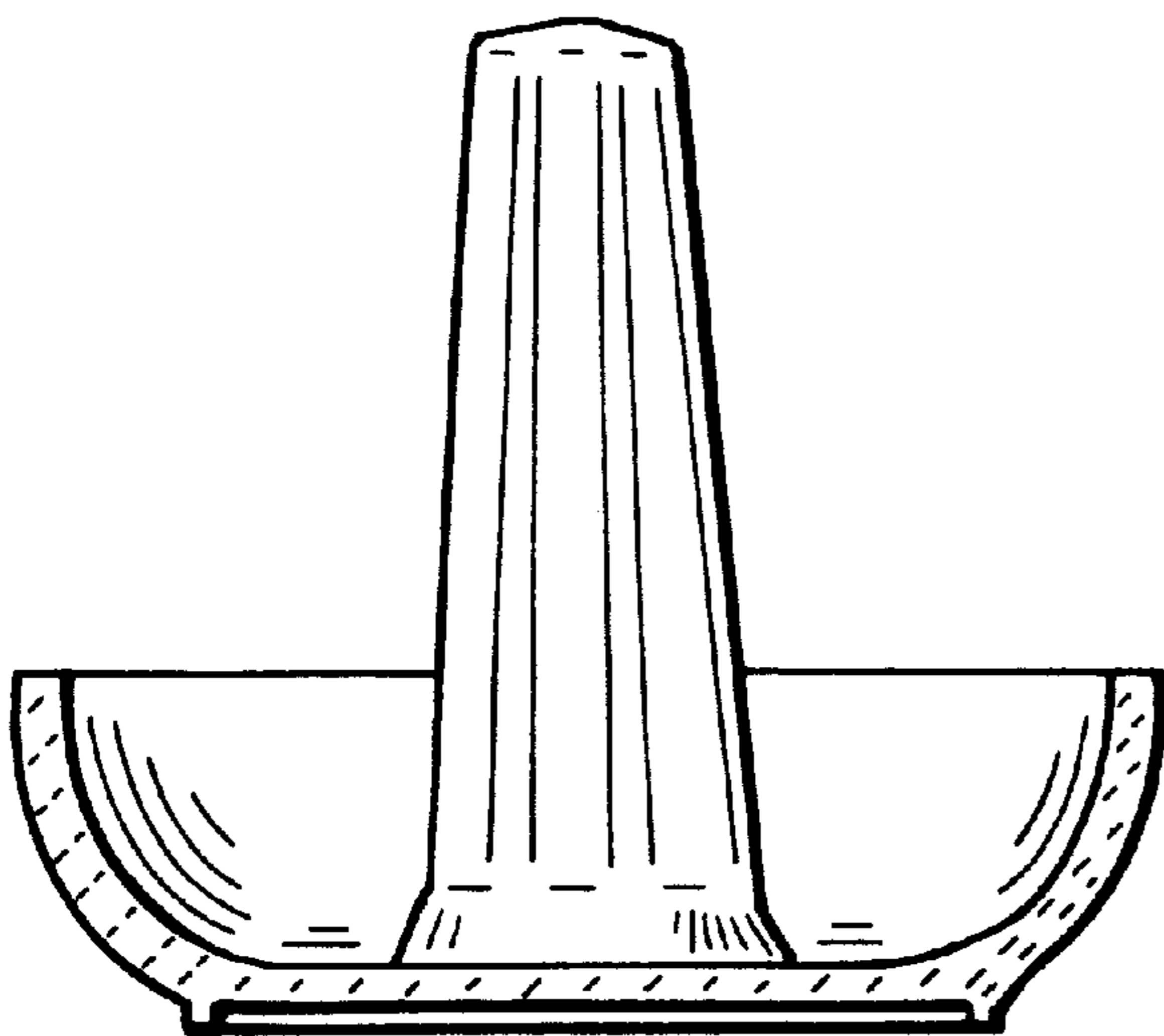

FIG. 9

